

Connection to fieldbus, CLV and Lector

Mobile hand-held scanners



Manufacturer

SICK AG
Erwin-Sick-Str. 1
79183 Waldkirch
Germany

Legal information

This work is protected by copyright. Any rights derived from the copyright shall be reserved for SICK AG. Reproduction of this document or parts of this document is only permissible within the limits of the legal determination of Copyright Law. Any modification, expurgation or translation of this document is prohibited without the express written permission of SICK AG.

The trademarks stated in this document are the property of their respective owner.

© SICK AG. All rights reserved.

Original document

This document is an original document of SICK AG.

Contents

Mobile hand-held scanners connected to CDF600-xxxx	4
Matchcode Teachin for CLV62x-65x.....	10
Matchcode Teachin for Lector	17
Data forwarding CLV62x-65x	24
AUX Input CLV62x-CLV65x	29
AUX Input Lector	34
Appendix	
Poweradapter	39
Connection diagrams	40

Mobile hand-held scanners connected to CDF600-xxxx

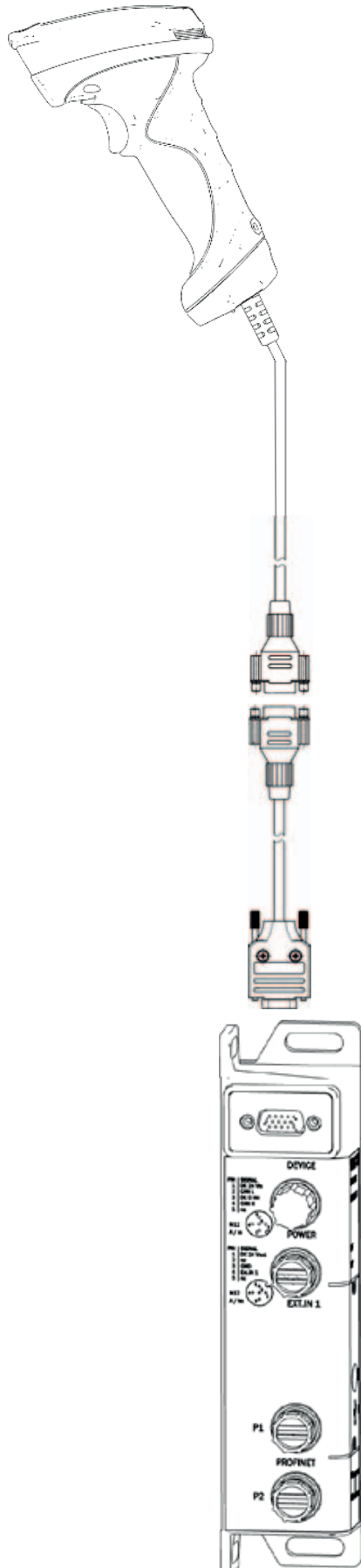

Setting of the connected device:

RS232, 57600 Baud, 8, n , 1

Data format:

<STX> Data <ETX>

RS232 Cable

Pin	Function
9	+5V
5	GND
3	RxD
2	TxD

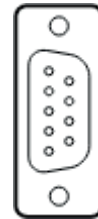

Power Adapter

Order No.

2056475 or

2057709

CDF600-0XXX

and

CDF600-2XXX

Function only available in Gateway Mode

Mode switch set to 2

=> Gatewaymode

Mobile hand-held scanners connected to CDF600-xxxx

HW19xx Series Quickformat

Scan the Configuration Code 2D or 1D



Mobile hand-held scanners connected to CDF600-xxxx

ZS36xx Series Quickformat



ZS3608

1. Scan code:



2. Scan code:

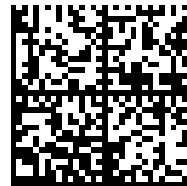

ZS3678

1. Scan code:



2. Scan code:

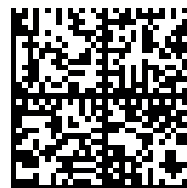

Mobile hand-held scanners connected to CDF600-xxxx



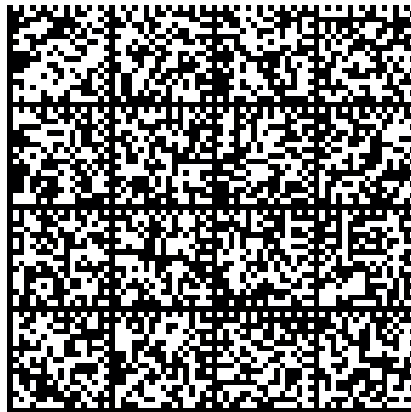

IDM Series Quickformat

To parameterize the hand-held scanner please scan the following codes in the shown sequence

2D (only for IDM2xx -3 devices):



Mobile hand-held scanners connected to CDF600-xxxx

<p>Factory Default Attention: This resets all parameters of the device</p>	
<p>Pair Mode (only / nur IDM 140-2BT)</p>	
<p>Place the scanner on the smart cradle, then you will hear one short beep to indicate the pairing process is activated. The scanner will give continuous short clicks and the link indicator of scanner will flash blue quickly during the pairing process. When you hear 4 beeps in ascending tone, the pairing process is completed. You will see the link indicator of scanner giving 1 blue blink per 2.5 seconds and the center indicator of the smart cradle turning steady blue</p>	
<p>RS232</p>	
<p>Program</p>	
<p>Baud Rate</p>	
<p>Option Code 8 (57600)</p>	

Mobile hand-held scanners connected to CDF600-xxxx

Data Frame	
Option Code 0 (8,n,1)	
STX / ETX Control	
Option Code 1	
Record Suffix	
Option Code 0	
FIN (Finish)	

Matchcode Teachin for CLV62x-65x

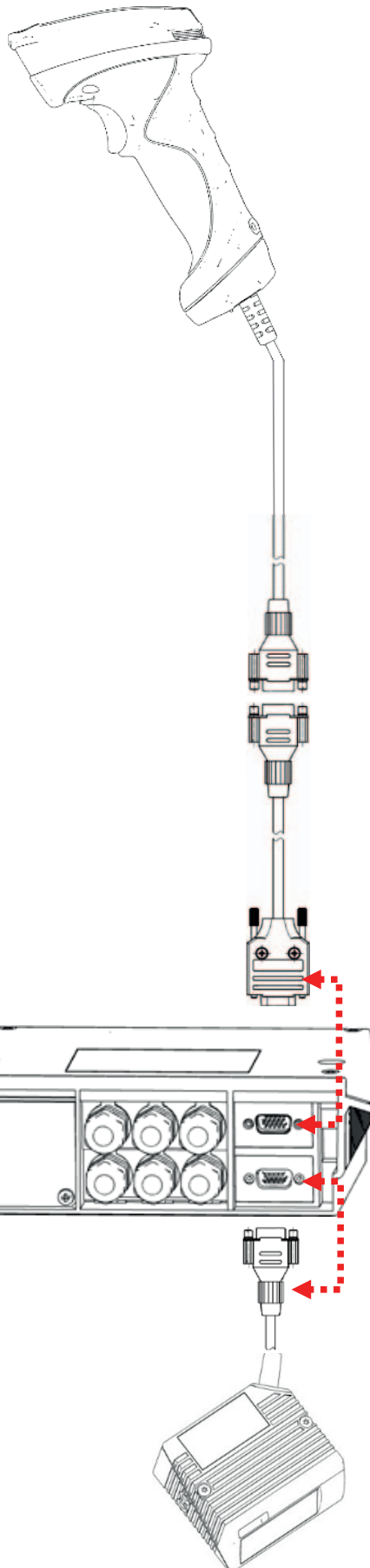

Setting of the connected device:

RS232, 57600 Baud, 8, n , 1

Data format:

<STX> **2MC10*** Data <ETX>

RS232 Cable

Pin	Function
9	+5V
5	GND
3	RxD
2	TxD

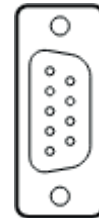

Power Adapter

Order No.

2056475 or

2057709

CDM420-0004

Or

CDM420-0007

*use adapter
2058003 for*

*connection of the
two internal*

SUB-D9PIN

connectors



CLV 62x–65x

V3.20 or higher

Matchcode Teachin for CLV62x-65x

HW19xx Series Quickformat

Scan the Configuration Code 2D or 1D



DEFAULT.



232BAD8.



PREBK29902324D4331302A.



SUFBK29903.

Matchcode Teachin for CLV62x-65x

ZS36xx Series Quickformat



ZS3608

1. Scan code:



2. Scan code:



ZS3678

1. Scan code:



2. Scan code:

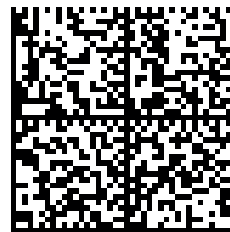

Matchcode Teachin for CLV62x-65x

IDM Series Quickformat

To parameterize the hand-held scanner please scan the following codes in the shown sequence

2D (only for IDM2xx -3 devices):



Factory Default Attantion: This resets all parameters of the device	
Pair Mode (only / nur IDM xx0-2 BT)	
<p>Place the scanner on the smart cradle, then you will hear one short beep to indicate the pairing process is activated. The scanner will give continuous short clicks and the link indicator of scanner will flash blue quickly during the pairing process. When you hear 4 beeps in ascending tone, the pairing process is completed. You will see the link indicator of scanner giving 1 blue blink per 2.5 seconds and the center indicator of the smart cradle turning steady blue</p>	
RS232	
Program	

Matchcode Teachin for CLV62x-65x

Baud Rate	
Option Code 8 (57600)	
Data Frame	
Option Code 0 (8,n,1)	
STX / ETX Control	
Option Code 1	
Record Suffix	
Option Code 0	
Preamble	Preamble 

Matchcode Teachin for CLV62x-65x

2 = Hex 32	 3
	 2
M = Hex 4D	 4
	 D
C = Hex 43	 4
	 3
1 = Hex 31 (Match1)	 3
	 1
0 = Hex 30 (temporarily)	 3

Matchcode Teachin for CLV62x-65x

	 0
* = Hex 2A (symbology don't care)	 2
	 A
FIN (Finish)	 FIN (Finish)
End	 END

Matchcode Teachin Lector (2MC short command)

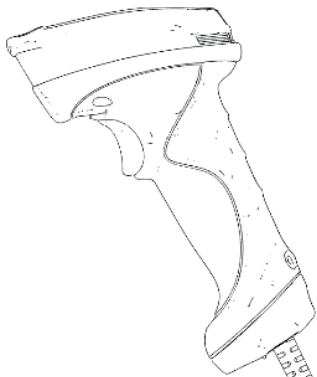

Setting of the connected device:

RS232, 57600 Baud, 8, n , 1

Data format:

<STX> **2MC10*** Data <ETX>

RS232 Cable SUB-D 9pin

Pin	Function
9	+5V
5	GND
3	RxD
2	TxD

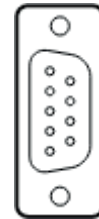

Power Adapter

Order No.

2056475 or

2057709

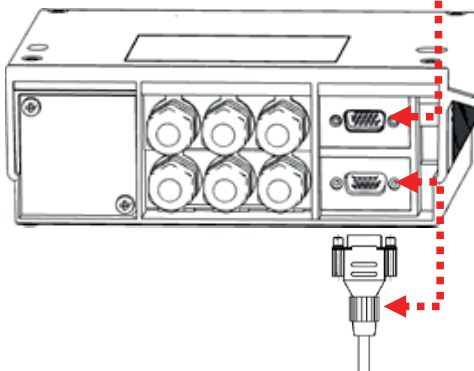

CDM420-0004

Or

CDM420-0007

use adapter

2058003 for

connection of the

two internal

SUB-D9PIN

connectors

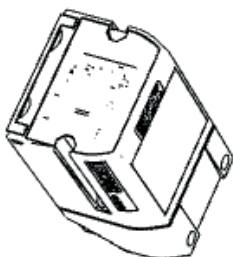

Lector6xx only with script,

use [2MC Script V2.00](#)

Matchcode Teachin Lector (2MC short command)

HW19xx Series Quickformat

Scan the Configuration Code 2D or 1D



DEFALT.



232BAD8.



PREBK29902324D4331302A.



SUFBK29903.

Matchcode Teachin Lector (2MC short command)

ZS36xx Series Quickformat



ZS3608

1. Scan code:



2. Scan code:



ZS3678

1. Scan code:



2. Scan code:

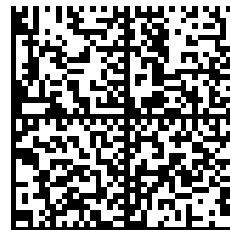





Matchcode Teachin Lector (2MC short command)

IDM Series Quickformat









To parameterize the handheld please scan the following codes in the shown sequence

2D (only for IDM2xx -3 devices):



Factory Default Attantion: This resets all parameters of the device	
Pair Mode (only / nur IDM xx0-2 BT)	
Place the scanner on the smart cradle, then you will hear one short beep to indicate the pairing process is activated. The scanner will give continuous short clicks and the link indicator of scanner will flash blue quickly during the pairing process. When you hear 4 beeps in ascending tone, the pairing process is completed. You will see the link indicator of scanner giving 1 blue blink per 2.5 seconds and the center indicator of the smart cradle turning steady blue	
RS232	
Program	

Matchcode Teachin Lector (2MC short command)

Baud Rate	
Option Code 8 (57600)	
Data Frame	
Option Code 0 (8,n,1)	
STX / ETX Control	
Option Code 1	
Record Suffix	
Option Code 0	
Preamble	<p style="text-align: center;">Preamble</p> 

Matchcode Teachin Lector (2MC short command)

<p>2 = Hex 32</p>	 <p style="text-align: center;">3</p>
	 <p style="text-align: center;">2</p>
<p>M = Hex 4D</p>	 <p style="text-align: center;">4</p>
	 <p style="text-align: center;">D</p>
<p>C = Hex 43</p>	 <p style="text-align: center;">4</p>
	 <p style="text-align: center;">3</p>
<p>1 = Hex 31 (Match1)</p>	 <p style="text-align: center;">3</p>
	 <p style="text-align: center;">1</p>
<p>0 = Hex 30 (temporarily)</p>	 <p style="text-align: center;">3</p>

Matchcode Teachin Lector (2MC short command)

	 0
* = Hex 2A (symbology don't care)	 2
	 A
FIN (Finish)	 FIN (Finish)
End	 END

Data forwarding CLV62x-65x

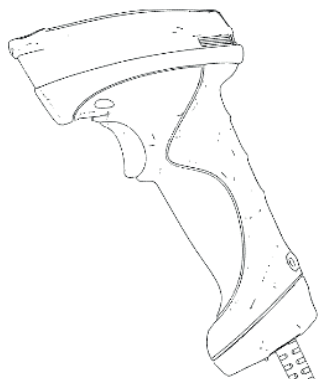

Setting of the connected device:

RS232, 57600 Baud, 8, n , 1

Data format:

<STX> / Data <ETX>

RS232 Cable SUB-D 9pin

Pin	Function
-----	----------

9	+5V
---	-----

5	GND
---	-----

3	RxD
---	-----

2	TxD
---	-----

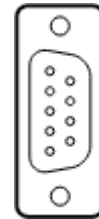

Power Adapter

Order No.

2056475 or

2057709

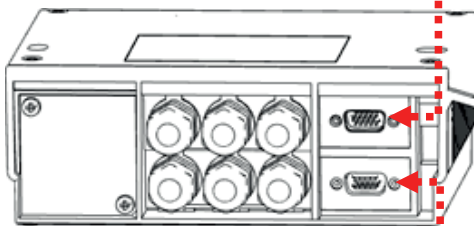

CDM420-0004

Or
CDM420-0007

*use adapter
2058003 for
connection of the
two internal
SUB-D9PIN
connectors*



CLV 62x–65x

V3.20 or higher

Data forwarding CLV62x-65x

HW19xx Series Quickformat

Scan the Configuration Code 2D or 1D



Data forwarding CLV62x-65x

ZS36xx Series Quickformat



ZS3608

1. Scan code:



2. Scan code:

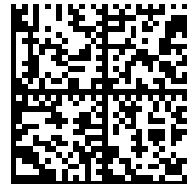

ZS3678

1. Scan code:



2. Scan code:







Data forwarding CLV62x-65x

IDM Series Quickformat













To parameterize the hand-held scanner please scan the following codes in the shown sequence

2D (only for IDM2xx -3 devices):



<p>Factory Default Attantion: This resets all parameters of the device</p>	
<p>Pair Mode (only / nur IDM 140-2 BT)</p>	
<p>Place the scanner on the smart cradle, then you will hear one short beep to indicate the pairing process is activated. The scanner will give continuous short clicks and the link indicator of scanner will flash blue quickly during the pairing process. When you hear 4 beeps in ascending tone, the pairing process is completed. You will see the link indicator of scanner giving 1 blue blink per 2.5 seconds and the center indicator of the smart cradle turning steady blue</p>	
<p>RS232</p>	
<p>Program</p>	
<p>Baud Rate</p>	

Data forwarding CLV62x-65x

Option Code 8 (57600)	
Data Frame	
Option Code 0 (8,n,1)	
STX / ETX Control	
Option Code 1	
Record Suffix	
Option Code 0	
Preamble	
Option Code 2	
Option Code F	
FIN (Finish)	
End	

AUX Input CLV62x-65x

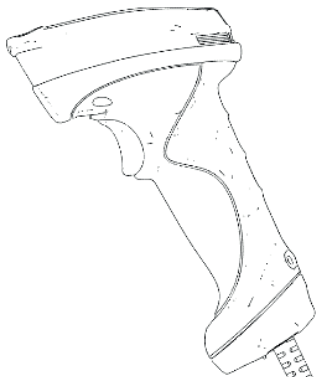

Setting of the connected device:

RS232, 57600 Baud, 8, n, 1

Data format:

<STX> > Data <ETX>

RS232 Cable SUB-D 9pin

Pin	Function
9	+5V
5	GND
3	RxD
2	TxD

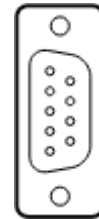

Power Adapter

Order No.

2056475 or

2057709

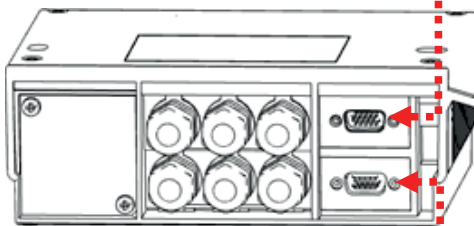

CDM420-0004

Or

CDM420-0007

use adapter

2058003 for

connection of the

two internal

SUB-D9PIN

connectors

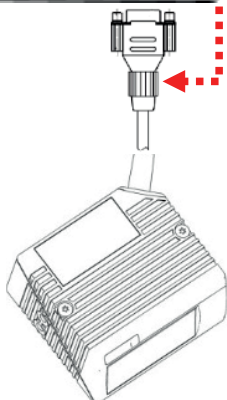

CLV 62x–65x

V3.20 or higher

AUX Input CLV62x-65x

HW19xx Series Quickformat

Scan the Configuration Code 2D or 1D



AUX Input CLV62x-65x

ZS36xx Series Quickformat



ZS3608

1. Scan code:



2. Scan code:

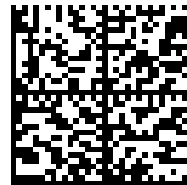

ZS3678

1. Scan code:



2. Scan code:

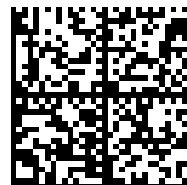

AUX Input CLV62x-65x

IDM Series Quickformat













To parameterize the hand-held scanner please scan the following codes in the shown sequence

2D (only for IDM2xx -3 devices):



Factory Default Attantion: This resets all parameters of the device	
Pair Mode (only / nur IDM 140-2BT)	
Place the scanner on the smart cradle, then you will hear one short beep to indicate the pairing process is activated. The scanner will give continuous short clicks and the link indicator of scanner will flash blue quickly during the pairing process. When you hear 4 beeps in ascending tone, the pairing process is completed. You will see the link indicator of scanner giving 1 blue blink per 2.5 seconds and the center indicator of the smart cradle turning steady blue	
RS232	
Program	
Baud Rate	

AUX Input CLV62x-65x

Option Code 8 (57600)	
Data Frame	
Option Code 0 (8,n,1)	
STX / ETX Control	
Option Code 1	
Record Suffix	
Option Code 0	
Preamble	
Option Code 3	
Option Code E	
FIN (Finish)	
End	

AUX Input Lector

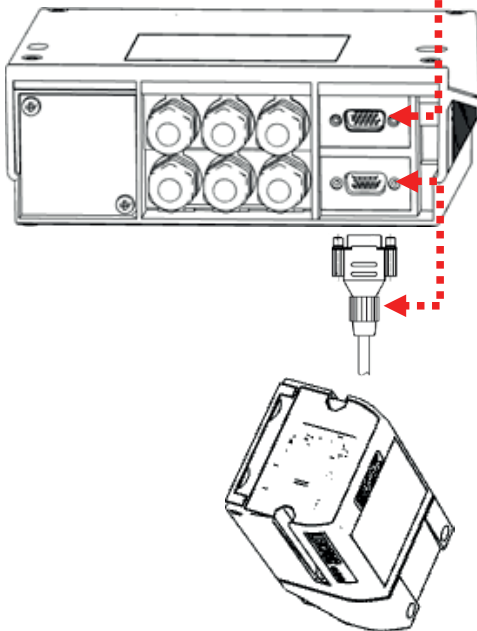
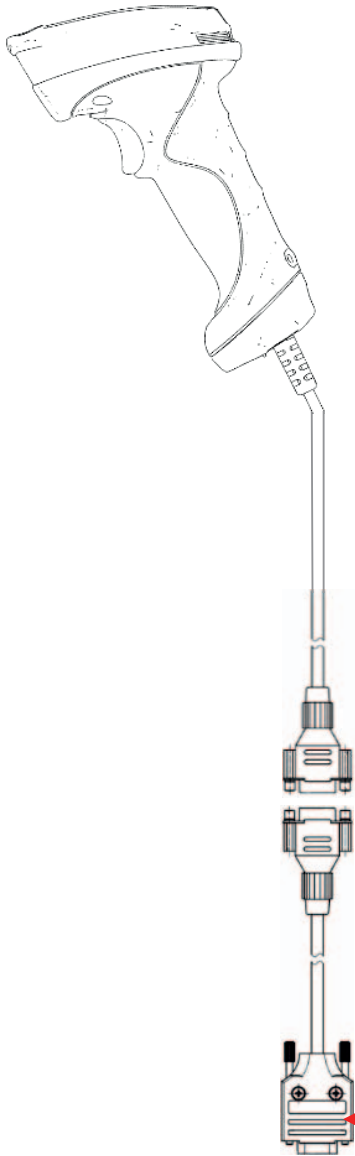

Setting of the connected device:

RS232, 57600 Baud, 8, n , 1

Data format:

<STX> > Data <ETX>

RS232 Cable SUB-D 9pin

Pin	Function
9	+5V
5	GND
3	RxD
2	TxD

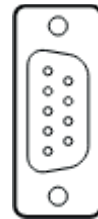

Power Adapter

Order No.

2056475 or

2057709

CDM420-0004

Or

CDM420-0007

*use adapter
2058003 for
connection of the
two internal*



SUB-D9PIN

connectors

Script for 2MC Commands is needed

Please look to:

[https://supportportal.sick.com/
release/Scripts-Lector62x-65/](https://supportportal.sick.com/release/Scripts-Lector62x-65/)

AUX Input Lector

HW19xx Series Quickformat

Scan the Configuration Code 2D or 1D



AUX Input Lector

ZS36xx Series Quickformat



ZS3608

1. Scan code:



2. Scan code:

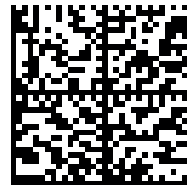

ZS3678

1. Scan code:



2. Scan code:

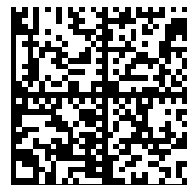





AUX Input Lector

IDM Series Quickformat













To parameterize the handheld please scan the following codes in the shown sequence

2D (only for IDM2xx -3 devices):



<p>Factory Default Attantion: This resets all parameters of the device</p>	
<p>Pair Mode (only / nur IDM 140-2BT)</p>	
<p>Place the scanner on the smart cradle, then you will hear one short beep to indicate the pairing process is activated. The scanner will give continuous short clicks and the link indicator of scanner will flash blue quickly during the pairing process. When you hear 4 beeps in ascending tone, the pairing process is completed. You will see the link indicator of scanner giving 1 blue blink per 2.5 seconds and the center indicator of the smart cradle turning steady blue</p>	
<p>RS232</p>	
<p>Program</p>	
<p>Baud Rate</p>	

AUX Input Lector

Option Code 8 (57600)	
Data Frame	
Option Code 0 (8,n,1)	
STX / ETX Control	
Option Code 1	
Record Suffix	
Option Code 0	
Preamble	
Option Code 3	
Option Code E	
FIN (Finish)	
End	

Appendix

Power Adapter

Order No.2056475 or 2057709

Input: 6,5—32V

Output: 5V

Output Current max.: 1.0A

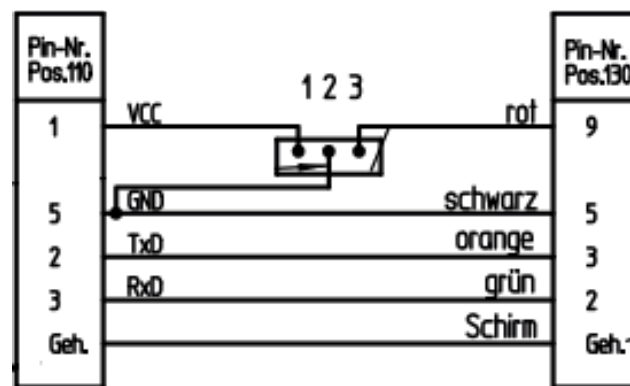
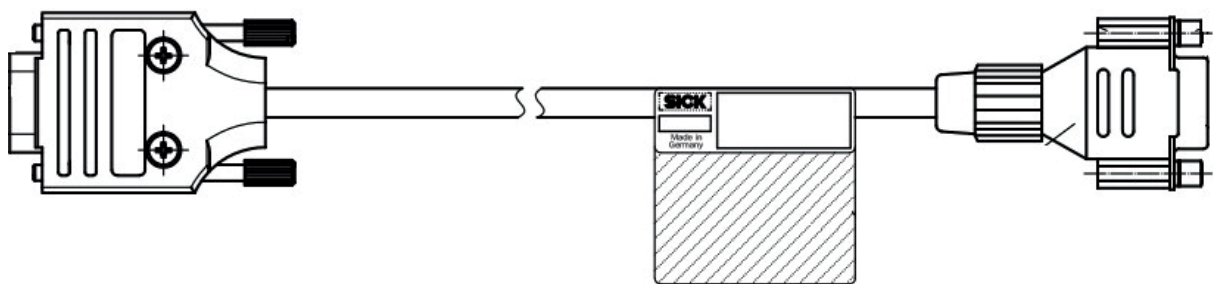

Appendix

Connection diagrams

PROFINET IO/RT

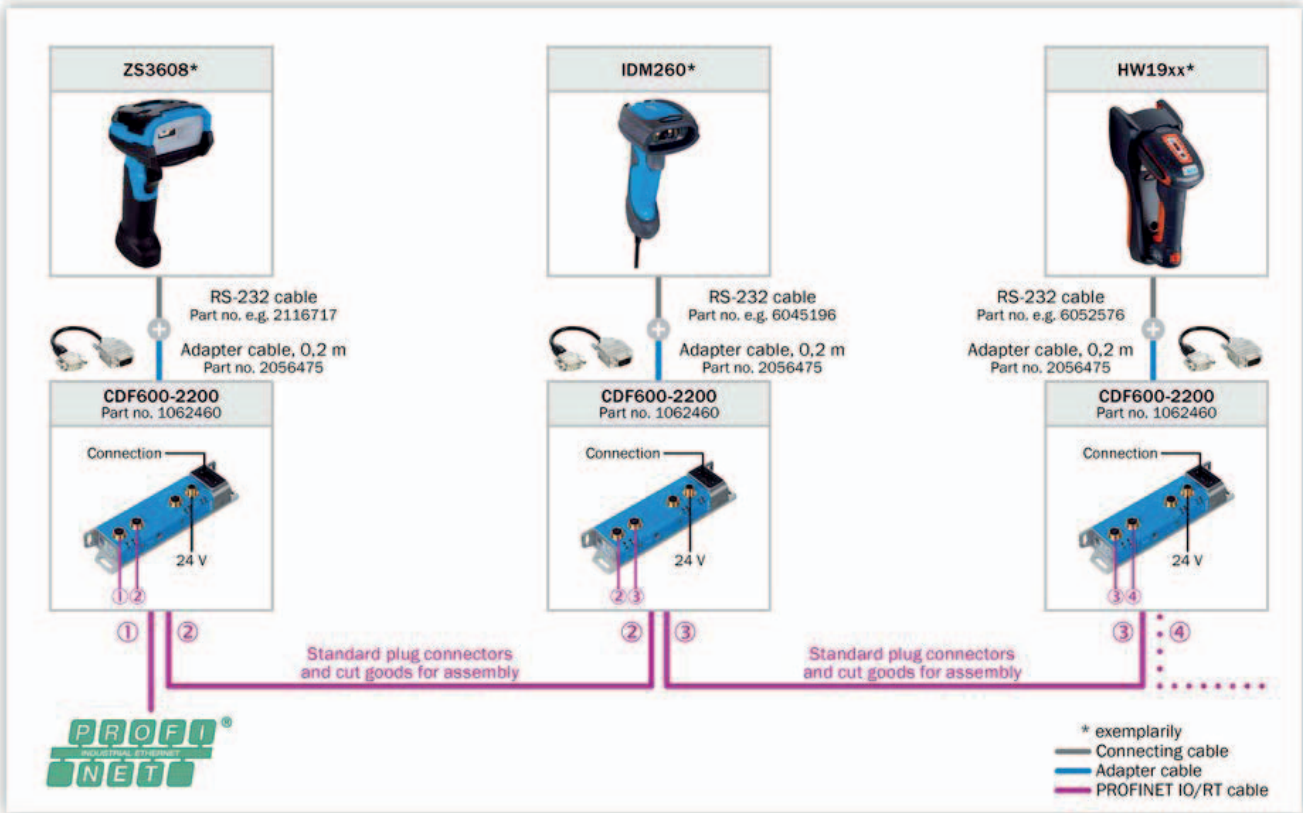

PROFIBUS DP

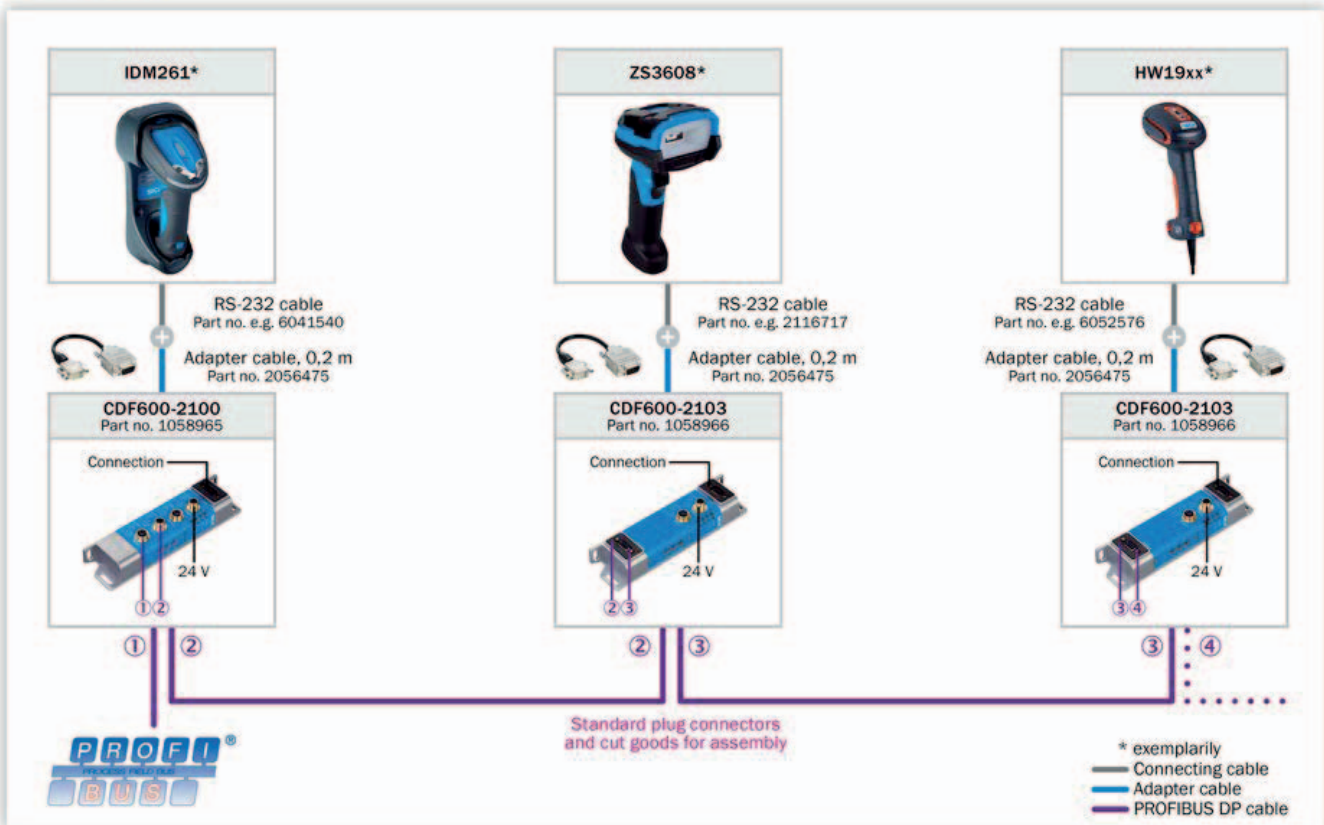

Appendix

Ethernet TCP/IP

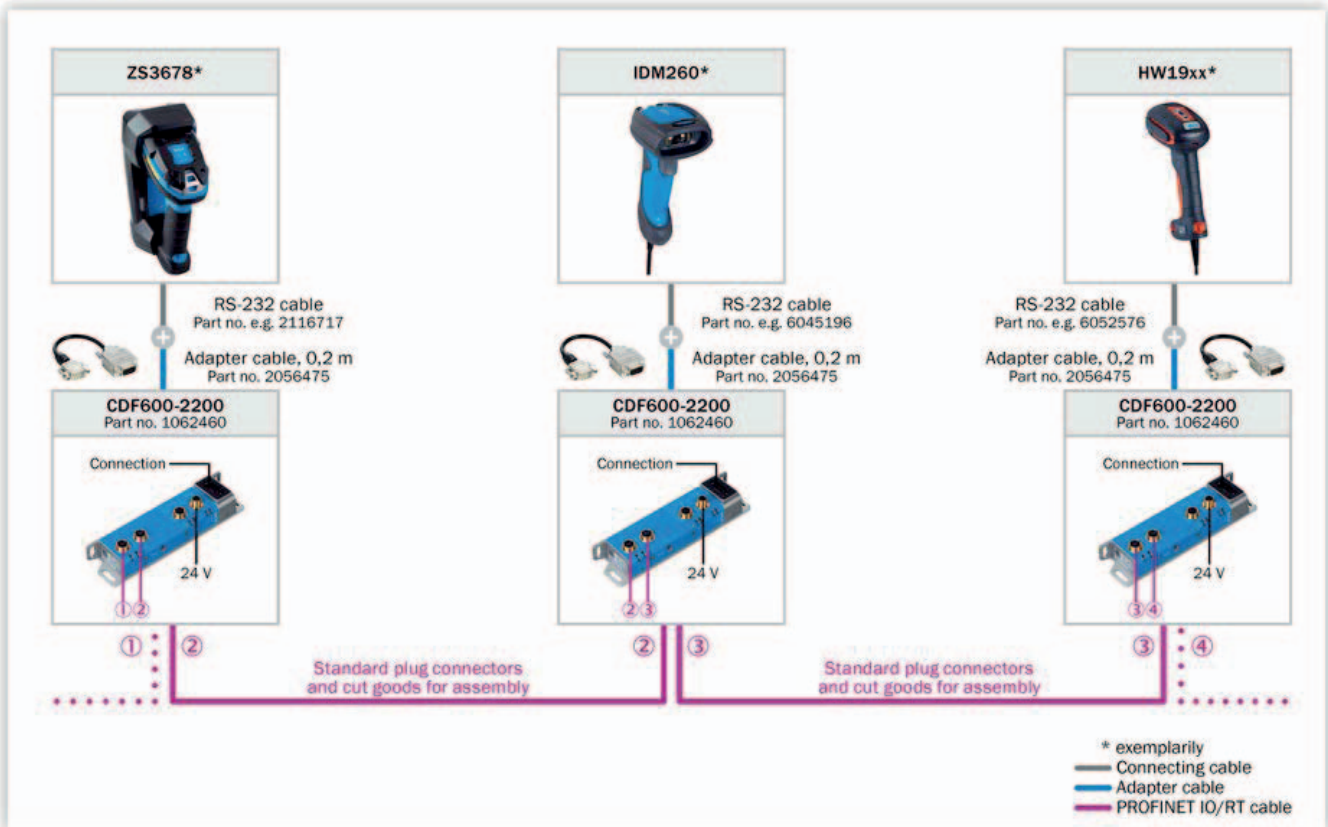

EtherCAT®

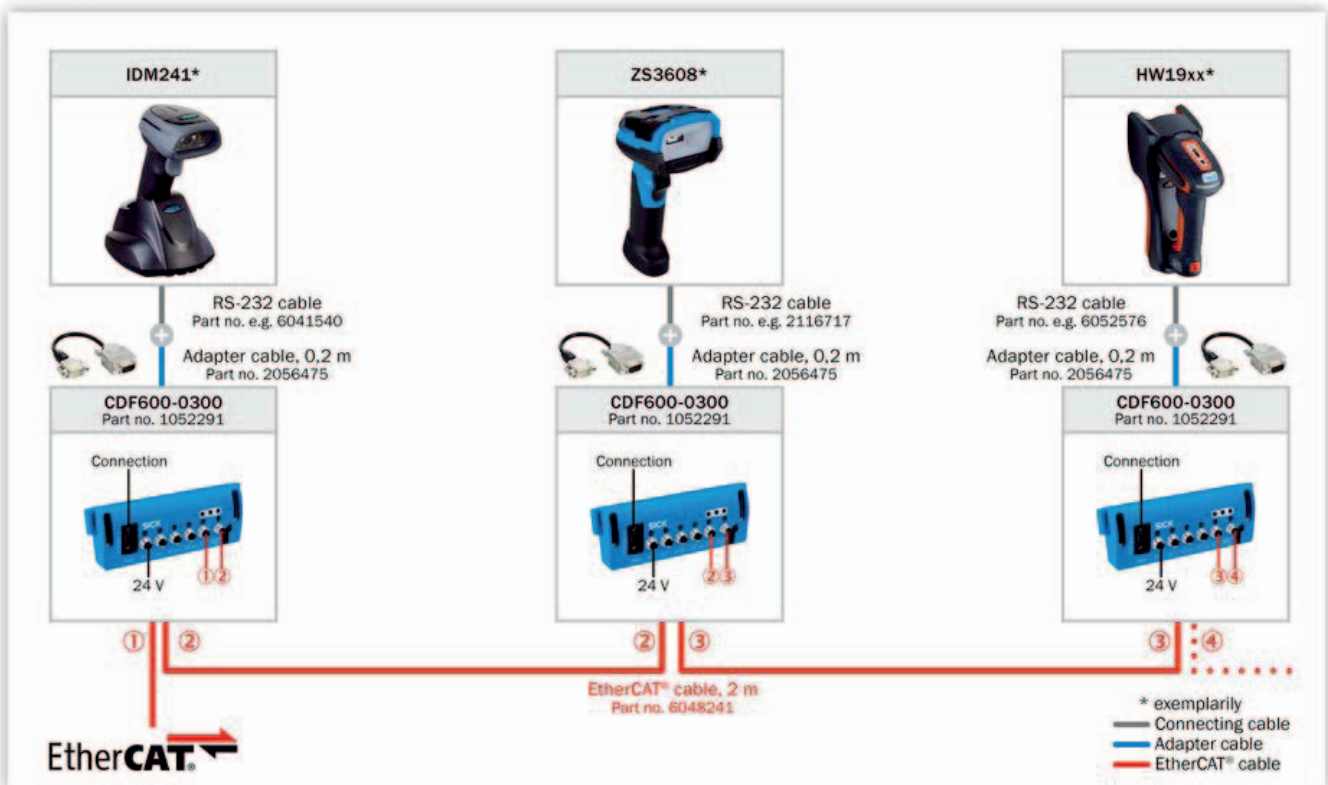

Appendix

DeviceNet™

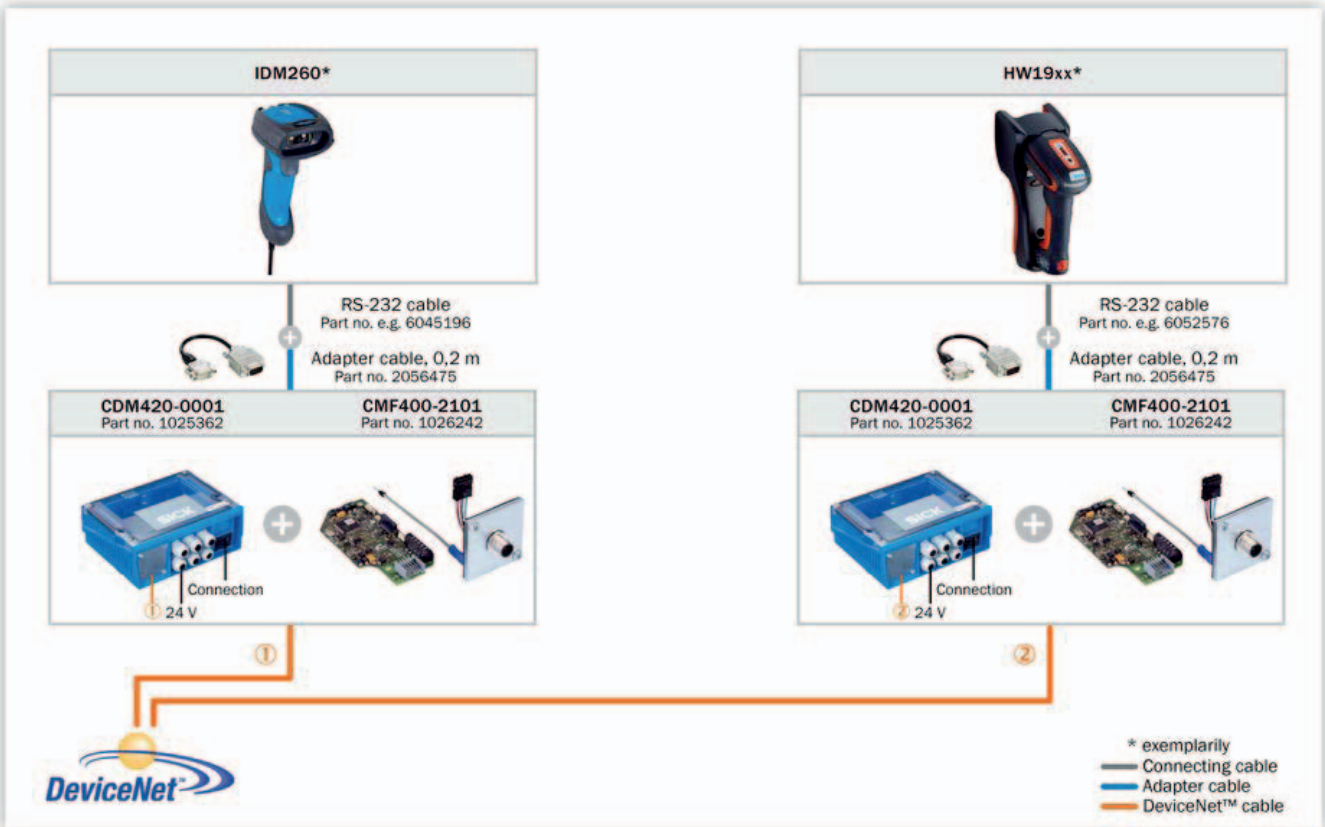

Looping-in via AUX

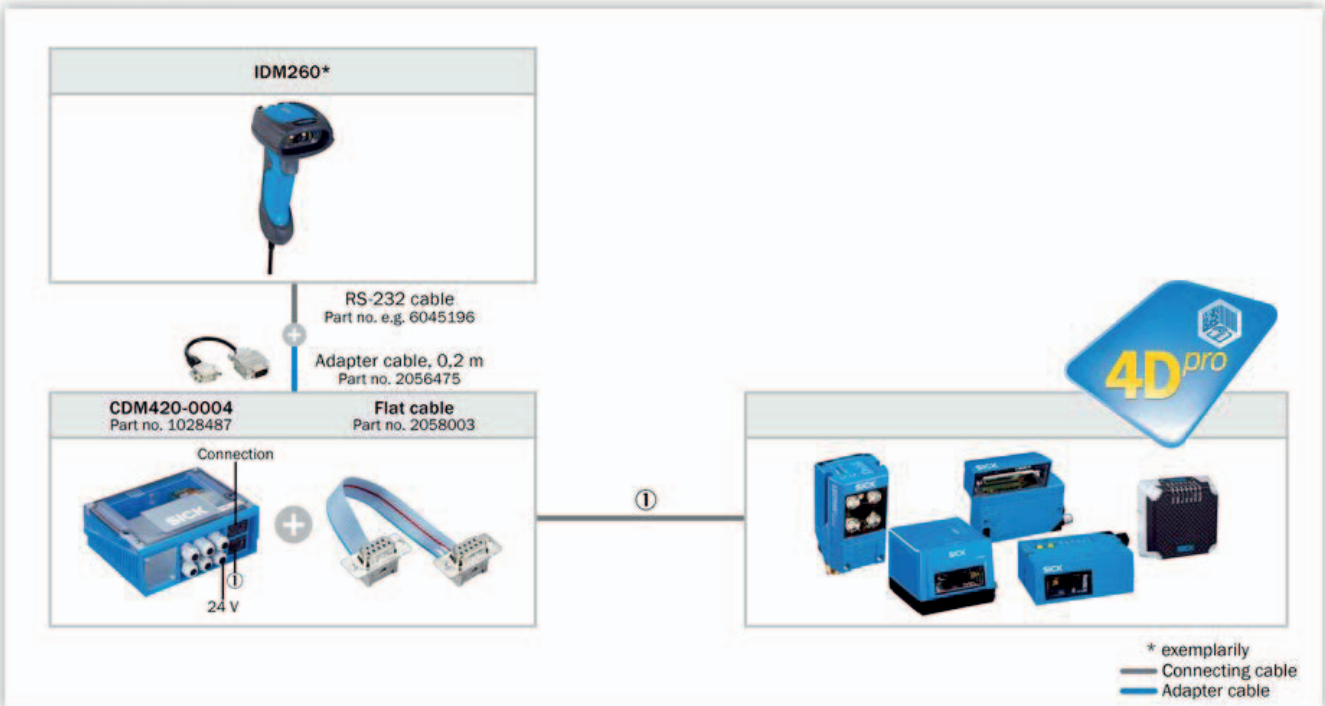

Australia

Phone +61 3 9457 0600
1800 334 802 – tollfree E-Mail
sales@sick.com.au

Austria

Phone +43 22 36 62 28 8-0
E-Mail office@sick.at

Belgium/Luxembourg

Phone +32 2 466 55 66
E-Mail info@sick.be

Brazil

Phone +55 11 3215-4900
E-Mail marketing@sick.com.br

Canada

Phone +1 905 771 14 44
E-Mail information@sick.com

Czech Republic

Phone +420 2 57 91 18 50
E-Mail sick@sick.cz

Chile

Phone +56 2 2274 7430
E-Mail info@schadler.com

China

Phone +86 20 2882 3600
E-Mail info.china@sick.net.cn

Denmark

Phone +45 45 82 64 00
E-Mail sick@sick.dk

Finland

Phone +358-9-2515 800
E-Mail sick@sick.fi

France

Phone +33 1 64 62 35 00
E-Mail info@sick.fr

Germany

Phone +49 211 5301-301
E-Mail info@sick.de

Hong Kong

Phone +852 2153 6300
E-Mail ghk@sick.com.hk

Hungary

Phone +36 1 371 2680
E-Mail office@sick.hu

India

Phone +91 22 6119 8900
E-Mail info@sick-india.com

Israel

Phone +972 4 6881000
E-Mail info@sick-sensors.com

Italy

Phone +39 02 274341
E-Mail info@sick.it

Japan

Phone +81 3 5309 2112
E-Mail support@sick.jp

Malaysia

Phone +6 03 8080 7425
E-Mail enquiry.my@sick.com

Mexico

Phone +52 (472) 748 9451
E-Mail mario.garcia@sick.com

Netherlands

Phone +31 30 2044 000
E-Mail info@sick.nl

New Zealand

Phone +64 9 415 0459
0800 222 278 – tollfree E-Mail sales@sick.co.nz

Norway

Phone +47 67 81 50 00
E-Mail sick@sick.no

Poland

Phone +48 22 539 41 00
E-Mail info@sick.pl

Romania

Phone +40 356 171 120
E-Mail office@sick.ro

Russia

Phone +7 495 775 05 30
E-Mail info@sick.ru

Singapore

Phone +65 6744 3732
E-Mail sales.gsg@sick.com

Slovakia

Phone +421 482 901201
E-Mail mail@sick-sk.sk

Slovenia

Phone +386 591 788 49
E-Mail office@sick.si

South Africa

Phone +27 11 472 3733
E-Mail info@sickautomation.co.za

South Korea

Phone +82 2 786 6321
E-Mail info@sickkorea.net

Spain

Phone +34 93 480 31 00
E-Mail info@sick.es

Sweden

Phone +46 10 110 10 00
E-Mail info@sick.se

Switzerland

Phone +41 41 619 29 39
E-Mail contact@sick.ch

Taiwan

Phone +886 2 2375-6288
E-Mail sales@sick.com.tw

Thailand

Phone +66 2645 0009
E-Mail Ronnie.Lim@sick.com

Turkey

Phone +90 216 528 50 00
E-Mail info@sick.com.tr

United Arab Emirates

Phone +971 4 88 65 878
E-Mail info@sick.ae

United Kingdom

Phone +44 1727 831121
E-Mail info@sick.co.uk

USA

Phone +1 800 325 7425
E-Mail info@sick.com

Vietnam

Phone +84 945452999
E-Mail Ngo.Duy.Linh@sick.com

Further locations at www.sick.com