

---

**User's  
Manual**

**DLM4000 Series  
Mixed Signal Oscilloscope  
Getting Started Guide**

---

# Product Registration

Thank you for purchasing YOKOGAWA products.

YOKOGAWA provides registered users with a variety of information and services. Please allow us to serve you best by completing the product registration form accessible from our website.

**<http://tmi.yokogawa.com/>**

---

Thank you for purchasing the DLM4000 Series Mixed Signal Oscilloscope. This getting started guide primarily explains the handling precautions and basic operations of the DLM4000. To ensure correct use, please read this manual thoroughly before beginning operation.  
Keep this manual in a safe place for quick reference in the event that a question arises.

## List of Manuals

The following manuals, including this one, are provided as manuals for the DLM4000 series. Please read all manuals.

Manual Title	Manual No.	Description
DLM4000 Series Mixed Signal Oscilloscope Features Guide	IM DLM4038-01EN	The manual explains all the DLM4000 features other than the communication interface features. (included in the accompanying manual CD)
DLM4000 Series Mixed Signal Oscilloscope User's Manual	IM DLM4038-02EN	The manual explains how to operate the DLM4000. (included in the accompanying manual CD)
DLM4000 Series Mixed Signal Oscilloscope Getting Started Guide	IM DLM4038-03EN	This guide. Provided as a printed manual. This guide explains the handling precautions, basic operations, and specifications of the DLM4000. (included in the accompanying manual CD)
DLM4000 Series Mixed Signal Oscilloscope Communication Interface User's Manual	IM DLM4038-17EN	The manual explains the DLM4000 communication interface features and instructions on how to use them. (included in the accompanying manual CD)
Model DLM4038, DLM4058 Mixed Signal Oscilloscope	IM DLM4038-92Z1	Document for China

The "EN" and "Z1" in the manual numbers are the language codes.

Contact information of Yokogawa offices worldwide is provided on the following sheet.

Document No.	Description
PIM 113-01Z2	List of worldwide contacts

## Notes

- The contents of this manual are subject to change without prior notice as a result of continuing improvements to the instrument's performance and functionality. The figures given in this manual may differ from those that actually appear on your screen.
- Every effort has been made in the preparation of this manual to ensure the accuracy of its contents. However, should you have any questions or find any errors, please contact your nearest YOKOGAWA dealer.
- Copying or reproducing all or any part of the contents of this manual without the permission of YOKOGAWA is strictly prohibited.
- The TCP/IP software of this product and the documents concerning it have been developed/created by YOKOGAWA based on the BSD Networking Software, Release 1 that has been licensed from the Regents of the University of California.

## Trademarks

- Microsoft, Internet Explorer, MS-DOS, Windows, Windows 7, Windows 8, Windows 8.1, and Windows 10 are either registered trademarks or trademarks of Microsoft Corporation in the United States and/or other countries.
- Adobe and Acrobat are either registered trademarks or trademarks of Adobe Systems Incorporated.
- DLM is a registered trademark of Yokogawa Electric Corporation.
- In this manual, the ® and TM symbols do not accompany their respective registered trademark or trademark names.
- Other company and product names are registered trademarks or trademarks of their respective holders.

---

## Revisions

- 1st Edition: November 2012
- 2nd Edition: February 2013
- 3rd Edition: June 2013
- 4th Edition: February 2015
- 5th Edition: May 2015
- 6th Edition: January 2016
- 7th Edition: October 2016
- 8th Edition: October 2017
- 9th Edition: July 2018
- 10th Edition: July 2019

# Checking the Contents of the Package

Unpack the box and check the contents before operating the instrument. If the wrong items have been delivered, if items are missing, or if there is a problem with the appearance of the items, contact your nearest YOKOGAWA dealer.

## DLM4000

Check that the product that you received is what you ordered by referring to the model name and suffix code given on the name plate on the left side panel.

MODEL	SUFFIX <sup>1</sup>	Specifications
DLM4038		Mixed Signal Oscilloscope, 8 channels+ 8-bit switchable logic, 350 MHz
DLM4058		Mixed Signal Oscilloscope, 8 channels+ 8-bit switchable logic, 500 MHz
Power cord <sup>2</sup>	-D	UL/CSA Standard power cord, Maximum rated voltage: 125 V
	-F	VDE Standard power cord, Maximum rated voltage: 250 V
	-Q	BS Standard power cord, Maximum rated voltage: 250 V
	-R	AS Standard power cord, Maximum rated voltage: 250 V
	-H	GB Standard power cord, Maximum rated voltage: 250 V
	-N	NBR Standard power cord, Maximum rated voltage: 250 V
	-T	Taiwanese Standard power cord, Maximum rated voltage: 125 V
	-B	Indian Standard power cord, Maximum rated voltage: 250 V
	-U	IEC Plug Type B power cord, Maximum rated voltage: 250 V
	-Y	No power cord included. <sup>3</sup>
Language	-HJ	Japanese
(One option can be	-HE	English
selected for the factory	-HC	Chinese
default message	-HG	German
language and panel	-HF	French
sheet language)	-HK	Korean
	-HL	Italian
	-HS	Spanish

1 For products whose suffix code contains "Z," an exclusive manual may be included. Please read it along with the standard manual.

2 Make sure that the attached power cord meets the designated standards of the country and area that you are using it in.

3 Prepare a power cord that complies with the standard specified by the country or region that the instrument will be used in.

## Checking the Contents of the Package

MODEL	SUFFIX <sup>1</sup>	Specifications
Options	/L16	Logic 16 bits
	/B5	Built-in printer
	/M1	Memory expansion to 6.25/25/62.5 M points
	/M2	Memory expansion to 12.5/62.5/125 M points
	/M3	Memory expansion to 25M/125M/250M points
	/P8	8 probe power terminals <sup>2</sup>
	/C1	GP-IB interface
	/C8	Approx. 7.2 GB of internal storage
	/G2	User-defined computation
	/G3	Power supply analysis
	/G4	Power supply analysis (includes user-defined computation)
	/F1	UART trigger and analysis
	/F2	I <sup>2</sup> C + SPI trigger and analysis
	/F3	UART + I <sup>2</sup> C + SPI trigger and analysis
	/F4	CAN + LIN trigger and analysis + CXPI analysis
	/F5	FlexRay trigger and analysis
	/F6	CAN + LIN + FlexRay trigger and analysis + CXPI analysis
	/F7	CAN + CAN FD + LIN trigger and analysis + CXPI analysis
	/F8	CAN + CAN FD + LIN + FlexRay trigger and analysis + CXPI analysis
	/F9	SENT trigger and analysis
	/F10	PSI5 analysis
	/F11	SENT + PSI5 trigger and analysis
	/E1	Four extra 701939 passive probes in addition to the four standard 701939 passive probes
	/E2	Four 701946 miniature passive probes instead of the four standard 701939 passive probes
	/E3	Eight 701946 miniature passive probes instead of the four standard 701939 passive probes

1 For products whose suffix code contains "Z," an exclusive manual may be included. Please read it along with the standard manual.

2 Option /P8 is necessary to use a probe that is not compatible with the probe interface and that requires a power supply. For detailed specifications, see sections 2.4 and 6.9.

### Note

The SUFFIX (suffix code) inscribed in the name plate on the DLM4000 case indicates the installed options at the time of factory shipment. After you add options through additional option licenses, check the options on the DLM4000 overview screen.\*

\* For details on additional option licenses, see "Overview (Overview)" in chapter 22, "Other Features" of the features guide, IM DLM4038-01EN.

## NO. (Instrument number)

When contacting the dealer from which you purchased the instrument, please give them the instrument number.

## Standard Accessories

The instrument is shipped with the following accessories. Make sure that all accessories are present and undamaged.

Item	Model or Part No.	Quantity	Specifications and Notes
Power cord <sup>1</sup>	A1006WD	1	UL/CSA standard
	A1009WD		VDE standard
	A1054WD		BS standard
	A1024WD		AS standard
	A1064WD		GB standard
	A1088WD		NBR standard
	A1100WD		Taiwanese standard
	A1101WD		Indian standard
	A1102WD	IEC Plug Type B	
Rubber feet	B8080FR	4	—
Printer roll paper <sup>2</sup>	B9988AE	1	—
500-MHz passive probe <sup>3</sup>	701939	4	—
Soft case	B8059GG	1	—
Front cover	B8069CH	1	—

## Checking the Contents of the Package

Item	Model or Part No.	Quantity	Specifications and Notes
Panel sheet	See below.	1	Japanese, Chinese, German, French, Korean, Italian, or Spanish
<b>Manuals</b>			
Printed manuals	IM DLM4038-03EN	1	Getting Started Guide (this guide)
	IM DLM4038-92Z1	1	Document for China
	PIM 113-01Z2	1	List of worldwide contacts
Manual CD	B8069RZ	1	Contains PDFs of the user's manuals (For the types of manuals that CD contains, see the next page.)

Standard accessories are not covered by warranty of this instrument.

### Power cord (one cord that matches the suffix code is included)<sup>1</sup>

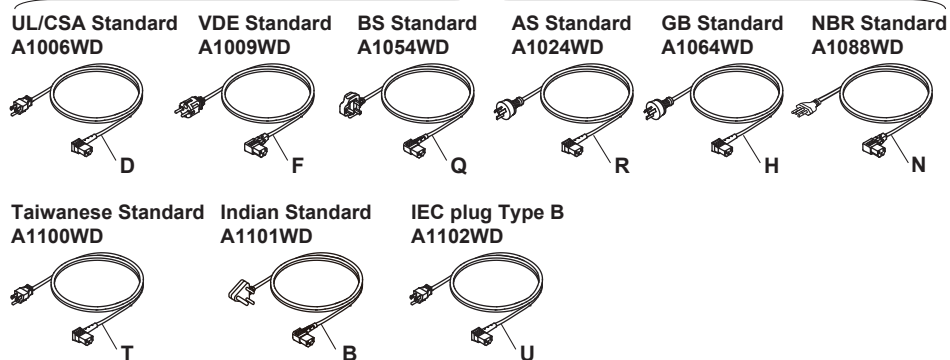

**Rubber feet**  
B8080FR 4 feet

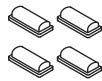

**Printer roll paper<sup>2</sup>**  
B9988AE 1 roll

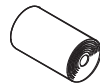

**Soft case**  
B8059GG

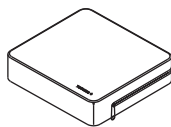

**500-MHz passive probe<sup>3</sup>**  
701939 4 probes

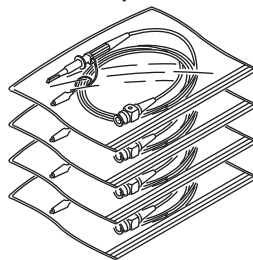

**Panel sheet**  
One of the following:

Japanese (HJ)  
Chinese (HC)  
German (HG)  
French (HF)  
Korean (HK)  
Italian (HL)  
Spanish (HS)

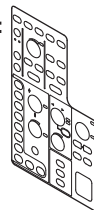

**Front panel protection cover**  
B8069CH

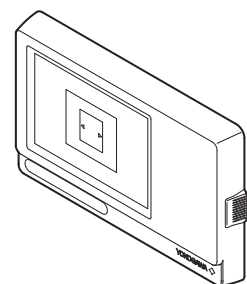

**Manuals**

• Printed manuals

• Manual CD

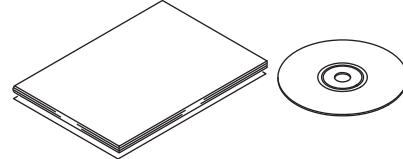

- 1 Make sure that the attached power cord meets the designated standards of the country and area that you are using it in. If the suffix code is -Y, a power cord is not included.
- 2 When using the optional built-in printer (/B5)
- 3 On models with the /E1 option, four 701939 passive probes are provided in addition to the four standard 701939 passive probes.  
On models with the /E2 option, four 701946 miniature passive probes are provided instead of the four standard 701939 passive probes.  
On models with the /E3 option, eight 701946 miniature passive probes are provided instead of the four standard 701939 passive probes.

## Checking the Contents of the Package

### Manual CD

The English folder in the manual CD contains the PDF files shown below. The CD also contains Japanese manuals.

File Name	Manual Title	Manual No.
Communication Interface.pdf	DLM4000 Series Mixed Signal Oscilloscope Communication Interface User's Manual	IM DLM4038-17EN
Features Guide&Users Manual.pdf	DLM4000 Series Mixed Signal Oscilloscope Features Guide	IM DLM4038-01EN
	DLM4000 Series Mixed Signal Oscilloscope User's Manual	IM DLM4038-02EN
Getting Started Guide.pdf	DLM4000 Series Mixed Signal Oscilloscope Getting Started Guide	IM DLM4038-03EN

To view the PDF data, you need Adobe Acrobat Reader or a software application that can open PDF data.

### WARNING

Never play this manual CD, which contains the user's manuals, in an audio CD player. Doing so may cause loss of hearing or speaker damage due to the large sounds that may be produced.

### French

### AVERTISSEMENT

Ce CD contient les manuels d'utilisation. Ne jamais insérer ce CD dans un lecteur de CD audio. Cela pourrait entraîner une perte d'audition ou l'endommagement des enceintes en raison du volume potentiellement élevé des sons produits.

### Optional Accessories (Sold separately)

The following optional accessories are available for purchase separately. For information about ordering accessories, contact your nearest YOKOGAWA dealer.

- Use the accessories specified in this manual. Moreover, use the accessories of this product only with Yokogawa products that specify them as accessories.
- Use the accessories of this product within the rated range of each accessory. When using several accessories together, use them within the specification range of the accessory with the lowest rating.

Item	Model/ Part No.	Min. Q'ty	Specifications	Manual No.
PBDH1000 differential probe with YOKOGAWA probe interface	701924	1	DC to 1 GHz bandwidth, 1 M $\Omega$ , $\pm$ 35 V maximum	IM 701924-01E
PBDH0150 differential probe with YOKOGAWA probe interface	701927	1	DC to 150 MHz bandwidth, $\pm$ 1400 V maximum	IM 701927-01EN
PBC100 current probe with YOKOGAWA probe interface	701928	1	DC to 100 MHz bandwidth, 30 Arms	IM 701928-01E
PBC050 current probe with YOKOGAWA probe interface	701929	1	DC to 50 MHz bandwidth, 30 Arms	
Passive probe	701939	1	DC to 500 MHz bandwidth, 10 M $\Omega$	IM 701939-01E
Miniature passive probe	701946	1	DC to 500 MHz bandwidth, 10 M $\Omega$	IM 701946-01EN
Passive probe (wide temperature range)	702906	1	DC to 200 MHz bandwidth, 10 M $\Omega$ , operating temperature range: -40°C to +85°C (excluding the phase adjustment side)	IM 702906-01EN
PBL100 logic probe	701988	1	100 MHz toggle frequency, 1 M $\Omega$	IM 701988-01E



## Checking the Contents of the Package

Item	Model/ Part No.	Min. Q'ty	Specifications	Manual No.
PBL250 logic probe	701989	1	250 MHz toggle frequency, 100 k $\Omega$	IM 701989-01E
100:1 high-voltage passive probe	701944	1	DC to 400 MHz bandwidth, 1000 Vrms, 1.2 m in length	IM 701944-01E
	701945	1	DC to 250 MHz bandwidth, 1000 Vrms, 3m in length	
FET probe*	700939	1	DC to 900 MHz bandwidth, 2.5 M $\Omega$ , 1.8 pF	IM 700939-01E
Differential probe*	700924	1	DC to 100 MHz bandwidth, $\pm$ 1400 V maximum	IM 700924-01E
	700925	1	DC to 15 MHz bandwidth, $\pm$ 500 V maximum	IM 700925-01E
	701920	1	DC to 500 MHz bandwidth, $\pm$ 30 V maximum (common-mode input)	IM 701920-01E
	701921	1	DC to 100 MHz bandwidth, $\pm$ 700 V maximum	IM 701921-01E
	701922	1	DC to 200 MHz bandwidth, $\pm$ 60V maximum (common-mode input)	IM 701922-01E
	701926	1	DC to 50 MHz bandwidth, 7000 V maximum (common-mode input)	IM 701926-01E
	Current probe*	701917	1	DC to 50 MHz bandwidth, 5 Arms
701918		1	DC to 120 MHz bandwidth, 5 Arms	IM 701917-01EN
701930		1	DC to 10 MHz bandwidth, 150 Arms	IM 701930-01E
701931		1	DC to 2 MHz bandwidth, 500 Arms	IM 701931-01E
701932		1	DC to 100 MHz bandwidth, 30 Arms	IM 701932-01E
701933		1	DC to 50 MHz bandwidth, 30 Arms	IM 701933-01E
PBL500 5 GHz low capacitance probe	701974	1	—	IM 701974-01E
Deskew signal source	701936	1	Approx. 0 to 5 V, approx. 0 to 100 mA, approx. 0 to 1 A, approx. 15 kHz	IM 701936-01EN
Mini clip adapter	700971	1 set	For 701939 passive probes	—
BNC adapter	700972	1	—	—
Logic probe accessory kit	701909	1 set	For the 701989	—
Probe stand	701919	1	—	IM 701919-01E
PCB adapter	366945	1 set	For 701939 passive probes	—
Solder-in adapter	366946	1 set	For 701939 passive probes	—
GO/NO-GO cable	366973	1	—	—
Soft carrying case	701968	1	For the DLM4000 series, shoulder type, three pockets	—
Rack mount kit	701969-E	1	EIA standard	IM 701969-02EN
	701969-J	1	JIS standard	IM 701969-01EN

Optional accessories (sold separately) are not covered by warranty of this instrument.

\* Used by connecting to a probe power terminal (/P8 option) or a probe power supply (701934; sold separately).

## Spare Parts (Sold Separately)

The spare parts below are available for purchase separately. Check that all contents are present and undamaged.

For information about ordering spare parts, contact your nearest YOKOGAWA dealer.

Name	Part No.	Minimum Q'ty	Note
Printer roll paper	B9988AE	10	Thermo-sensitive paper, 111 mm $\times$ 10 m

# Safety Precautions

This product is designed to be used by a person with specialized knowledge.

This instrument is an IEC safety class I instrument (provided with a terminal for protective earth grounding).

The general safety precautions described herein must be observed during all phases of operation. If the instrument is used in a manner not specified in this manual, the protection provided by the instrument may be impaired.

This manual is part of the product and contains important information. Store this manual in a safe place close to the instrument so that you can refer to it immediately. Keep this manual until you dispose of the instrument.

YOKOGAWA assumes no liability for the customer's failure to comply with these requirements.

## The following symbols are used on this instrument.



Warning: handle with care. Refer to the user's manual or service manual. This symbol appears on dangerous locations on the instrument which require special instructions for proper handling or use. The same symbol appears in the corresponding place in the manual to identify those instructions.



Ground (earth) or functional ground terminal (do not use this terminal as a protective ground terminal.)



Alternating current



Direct current



On (power)



Off (power)

## French



Avertissement : À manipuler délicatement. Toujours se reporter aux manuels d'utilisation et d'entretien. Ce symbole a été apposé aux endroits dangereux de l'instrument pour lesquels des consignes spéciales d'utilisation ou de manipulation ont été émises. Le même symbole apparaît à l'endroit correspondant du manuel pour identifier les consignes qui s'y rapportent.



Borne de terre ou borne de terre fonctionnelle (ne pas utiliser cette borne comme prise de terre.)



Courant alternatif



Courant direct



Marche (alimentation)



Arrêt (alimentation)

---

## Failure to comply with the precautions below could lead to injury or death or damage to the instrument.

---

### WARNING

#### **Use the Instrument Only for Its Intended Purpose**

This instrument is a waveform measuring device that monitors and measures electrical signals. Do not use this instrument for anything other than as a waveform measuring device.

#### **Check the Physical Appearance**

Do not use the instrument if there is a problem with its physical appearance.

#### **Use the Correct Power Supply**

Make sure that the power supply voltage matches the instrument's rated supply voltage and that it does not exceed the maximum voltage range of the power cord to use.

#### **Use the Correct Power Cord and Plug**

To prevent the possibility of electric shock or fire, be sure to use the power cord for the instrument. The main power plug must be plugged into an outlet with a protective earth terminal. Do not invalidate this protection by using an extension cord without protective earth grounding. Further, do not use this power cord with other instruments.

#### **Connect the Protective Grounding Terminal**

Make sure to connect the protective earth to prevent electric shock before turning on the power. The power cord that you can use for the instrument is a three-prong cord. Connect the power cord to a properly grounded three-prong outlet.

#### **Do Not Impair the Protective Grounding**

Never cut off the internal or external protective earth wire or disconnect the wiring of the protective earth terminal. Doing so may result in electric shock or damage to the instrument.

#### **Do Not Use When the Protection Functions Are Defective**

Before using this instrument, check that the protection functions, such as the protective grounding and fuse, are working properly. If you suspect a defect, do not use the instrument.

#### **Do Not Operate in an Explosive Atmosphere**

Do not operate the instrument in the presence of flammable gasses or vapors. Doing so is extremely dangerous.

#### **Do Not Remove the Covers or Disassemble or Alter the Instrument**

Only qualified YOKOGAWA personnel may remove the covers and disassemble or alter the instrument. The inside of the instrument is dangerous because parts of it have high voltages.

#### **Ground the Instrument before Making External Connections**

Securely connect the protective grounding before connecting to the item under measurement or to an external control unit. Before touching a circuit, turn off its power and check that it has no voltage. To prevent the possibility of electric shock or an accident, connect the ground of the probe and input connector to the ground of the item being measured.

## Safety Precautions

---

### Measurement Category

The measurement category of the DLM4000 signal input terminals is Other (O). Do not use it to measure the main power supply or for Measurement Categories II, III, and IV.

### Install or Use the Instrument in Appropriate Locations

- Do not install or use the instrument outdoors or in locations subject to rain or water.
- Install the instrument so that you can immediately remove the power cord if an abnormal or dangerous condition occurs.

### Accessories

Use the accessories specified in this manual. Moreover, use the accessories of this product only with Yokogawa products that specify them as accessories.

Do not use faulty accessories.

---

---

## CAUTION

---

### Operating Environment Limitations

This product is classified as Class A (for use in industrial environments). Operation of this product in a residential area may cause radio interference, in which case the user will be required to correct the interference.

---

## French

---

## AVERTISSEMENT

### Utiliser l'instrument aux seules fins pour lesquelles il est prévu

Cet instrument est un appareil de mesure de forme d'onde pour le contrôle et la mesure des signaux électriques. Ne pas utiliser cet instrument à d'autres fins que celles de mesure de forme d'onde.

### Inspecter l'apparence physique

Ne pas utiliser l'instrument si son intégrité physique semble être compromise.

### Vérifier l'alimentation

Assurez-vous que la tension d'alimentation correspond à la tension d'alimentation nominale de l'appareil et qu'elle ne dépasse pas la plage de tension maximale du cordon d'alimentation à utiliser.

### Utiliser le cordon d'alimentation et la fiche adaptés

Pour éviter tout risque de choc électrique, utiliser exclusivement le cordon d'alimentation prévu pour cet instrument. La fiche doit être branchée sur une prise secteur raccordée à la terre. En cas d'utilisation d'une rallonge, celle-ci doit être impérativement reliée à la terre. Par ailleurs, ne pas utiliser ce cordon d'alimentation avec d'autres instruments.

### Brancher la prise de terre

Avant de mettre l'instrument sous tension, penser à brancher la prise de terre pour éviter tout choc électrique. Le cordon d'alimentation que vous utilisez pour l'instrument est un cordon à trois broches. Brancher le cordon d'alimentation sur une prise de courant à trois plots et mise à la terre.

**Ne pas entraver la mise à la terre de protection**

Ne jamais neutraliser le fil de terre interne ou externe, ni débrancher la borne de mise à la terre. Cela pourrait entraîner un choc électrique ou endommager l'instrument.

**Ne pas utiliser lorsque les fonctions de protection sont défectueuses**

Avant d'utiliser l'instrument, vérifier que les fonctions de protection, telles que le raccordement à la terre et le fusible, fonctionnent correctement. En cas de dysfonctionnement possible, ne pas utiliser l'instrument.

**Ne pas utiliser dans un environnement explosif**

Ne pas utiliser l'instrument en présence de gaz ou de vapeurs inflammables. Cela pourrait être extrêmement dangereux.

**Ne pas retirer le capot, ni démonter ou modifier l'instrument**

Seul le personnel YOKOGAWA qualifié est habilité à retirer le capot et à démonter ou modifier l'instrument. Certains composants à l'intérieur de l'instrument sont à haute tension et par conséquent, représentent un danger.

**Relier l'instrument à la terre avant de le brancher sur des connexions externes**

Toujours relier l'instrument à la terre avant de le brancher aux appareils à mesurer ou à une commande externe. Avant de toucher un circuit, mettre l'instrument hors tension et vérifier l'absence de tension. Pour éviter tout risque de choc électrique, brancher la terre de la sonde et du connecteur d'entrée sur la terre de l'appareil à mesurer.

**Catégorie de mesure**

La catégorie de mesure des terminaux d'entrée de signal du DLM4000 est Autre (O). Ne pas l'utiliser pour mesurer l'alimentation électrique, ni pour les catégories de mesure II, III et IV.

**Installer et utiliser l'instrument aux emplacements appropriés**

- Ne pas installer, ni utiliser l'instrument à l'extérieur ou dans des lieux exposés à la pluie ou à l'eau.
- Installer l'instrument de manière à pouvoir immédiatement le débrancher du secteur en cas de fonctionnement anormal ou dangereux.

**Accessoires**

Utiliser les accessoires spécifiés dans ce manuel. En outre, utiliser les accessoires de ce produit uniquement avec des produits Yokogawa pour lesquels ils sont spécifiés comme accessoires.

Ne pas utiliser d'accessoires défectueux.

---

---

**ATTENTION**

---

---

**Limitations relatives à l'environnement opérationnel**

Ce produit est classé dans classe A (pour utilisation dans des environnements industriels). L'utilisation de ce produit dans un zone résidentielle peut entraîner une interférence radio que l'utilisateur sera tenu de rectifier.

---

---

---

# Regulations and Sales in Each Country or Region

## Waste Electrical and Electronic Equipment



### Waste Electrical and Electronic Equipment (WEEE), Directive

(This directive is valid only in the EU.)

This product complies with the WEEE directive marking requirement. This marking indicates that you must not discard this electrical/electronic product in domestic household waste.

#### Product Category

With reference to the equipment types in the WEEE directive, this product is classified as a “Monitoring and control instruments” product.

When disposing of products in the EU, contact your local Yokogawa Europe B.V. office. Do not dispose in domestic household waste.

## EU Battery Directive



### EU Battery Directive

(This directive is valid only in the EU.)

Batteries are included in this product. This marking indicates they shall be sorted out and collected as ordained in the EU battery directive.

Battery type: Lithium battery

You cannot replace batteries by yourself. When you need to replace batteries, contact your local Yokogawa Europe B.V. office.

## Authorized Representative in the EEA

Yokogawa Europe B.V. is the authorized representative of Yokogawa Test & Measurement Corporation for this product in the EEA. To contact Yokogawa Europe B.V., see the separate list of worldwide contacts, PIM 113-01Z2.

## 關於在台灣銷售

This section is valid only in Taiwan.

關於在台灣所販賣的符合其相關規定的電源線 A1100WD 的限用物質含量信息，請至下麵的網址進行查詢

<https://tmi.yokogawa.com/support/service-warranty-quality/product-compliance/>

## Disposal

When disposing of YOKOGAWA products, follow the laws and ordinances of the country or region where the product will be disposed of.

---

# Conventions Used in This Manual

## Prefixes k and K

Prefixes k and K used before units are distinguished as follows:

k: Denotes 1000.

Example: 100 kS/s (sample rate)

K: Denotes 1024.

Example: 720 KB (file size)

## Displayed Characters

Bold characters in procedural explanations are used to indicate panel keys and soft keys that are used in the procedure and menu items that appear on the screen.

## Notes

The notes and cautions in this manual are categorized using the following symbols.



*Improper handling or use can lead to injury to the user or damage to the instrument.* This symbol appears on the instrument to indicate that the user must refer to the user's manual for special instructions. The same symbol appears in the corresponding place in the user's manual to identify those instructions. In the manual, the symbol is used in conjunction with the word "WARNING" or "CAUTION."

### **WARNING**

Calls attention to actions or conditions that could cause serious or fatal injury to the user, and precautions that can be taken to prevent such occurrences.

### **CAUTION**

Calls attention to actions or conditions that could cause light injury to the user or damage to the instrument or user's data, and precautions that can be taken to prevent such occurrences.

## French

### **AVERTISSEMENT**

Attire l'attention sur des gestes ou des conditions susceptibles de provoquer des blessures graves (voire mortelles), et sur les précautions de sécurité pouvant prévenir de tels accidents.

### **ATTENTION**

Attire l'attention sur des gestes ou des conditions susceptibles de provoquer des blessures légères ou d'endommager l'instrument ou les données de l'utilisateur, et sur les précautions de sécurité susceptibles de prévenir de tels accidents.

### **Note**

Calls attention to information that is important for proper operation of the instrument.

---

# Contents

List of Manuals.....	i
Checking the Contents of the Package.....	iii
Safety Precautions.....	viii
Regulations and Sales in Each Country or Region.....	xii
Conventions Used in This Manual.....	xiii

## Chapter 1 Component Names and Functions

1.1 Top Panel, Front Panel, Right Side Panel, Left Side Panel, and Rear Panel.....	1-1
1.2 Keys and Knobs.....	1-4
1.3 Screens.....	1-11

## Chapter 2 Making Preparations for Measurements

2.1 Handling Precautions.....	2-1
2.2 Installing the Instrument.....	2-3
⚠ 2.3 Connecting the Power Supply and Turning the Power Switch On and Off.....	2-6
⚠ 2.4 Connecting Probes.....	2-10
⚠ 2.5 Correcting a Probe Phase.....	2-15
⚠ 2.6 Connecting Logic Probes.....	2-17
2.7 Attaching the Panel Sheet.....	2-19
⚠ 2.8 Loading Roll Paper into the Built-In Printer (Option).....	2-20

## Chapter 3 Common Operations

3.1 Key and Jog Shuttle Operations.....	3-1
3.2 Entering Values and Strings.....	3-3
3.3 Using USB Keyboards and Mouse Devices.....	3-5
3.4 Synchronizing the Clock.....	3-11
3.5 Performing Auto Setup.....	3-12
3.6 Resetting the DLM4000 to Its Factory Default Settings.....	3-14
3.7 Calibrating the DLM4000.....	3-15
3.8 Starting and Stopping Waveform Acquisition.....	3-16
3.9 Displaying Help.....	3-17

## Chapter 4 Rear Panel Input and Output

⚠ 4.1 External Trigger Input (TRIGGER IN).....	4-1
⚠ 4.2 Trigger Output (TRIGGER OUT).....	4-2
⚠ 4.3 Video Signal Output (VIDEO OUT (XGA)).....	4-4
⚠ 4.4 GO/NO-GO Signal Output.....	4-5

## Chapter 5 Troubleshooting, Maintenance, and Inspection

5.1 If a Problem Occurs.....	5-1
5.2 Recommended Part Replacement.....	5-2



**Chapter 6 Specifications**

6.1	Signal Input Section .....	6-1
6.2	Triggering Section .....	6-4
6.3	Time Axis .....	6-8
6.4	Display .....	6-8
6.5	Features .....	6-9
6.6	Built-in Printer (/B5 Option) .....	6-16
6.7	Storage .....	6-16
6.8	USB Ports for Peripherals .....	6-16
6.9	Auxiliary I/O Section .....	6-17
6.10	Computer Interface .....	6-18
6.11	General Specifications .....	6-19
6.12	External Dimensions .....	6-22

**Appendix**

Appendix 1	Relationship between the Time Axis Setting, Record Length, and Sample Rate .....	App-1
Appendix 2	USB Keyboard Key Assignments .....	App-11



# 1.1 Top Panel, Front Panel, Right Side Panel, Left Side Panel, and Rear Panel

## Top Panel

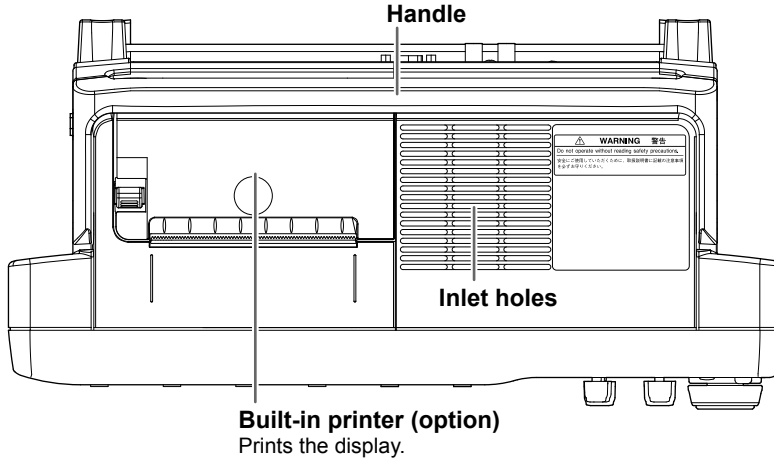

## Front Panel

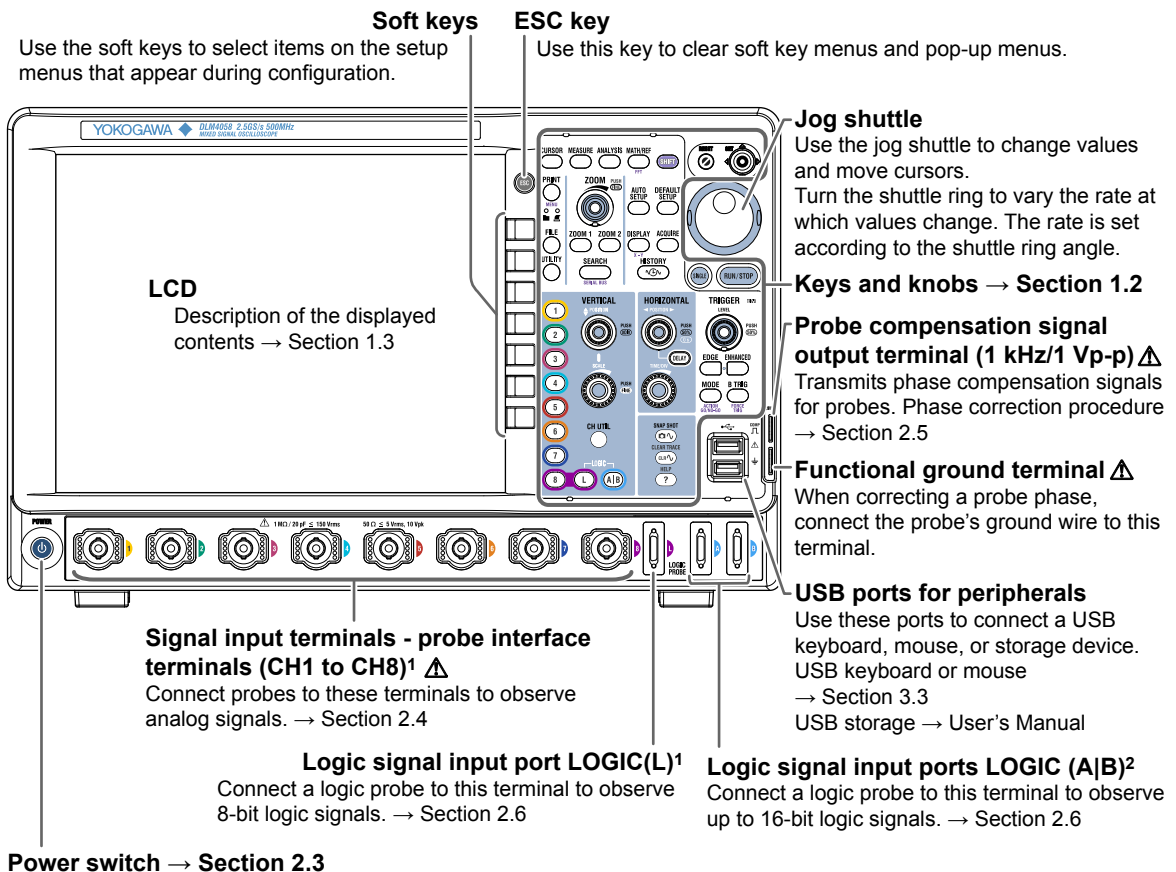

1 Analog signal input channel CH8 and 8-bit logic signal input port L cannot measure signals simultaneously. The signal that corresponds to the key that is illuminated, either CH8 or L, can be measured.  
2 Logic signal input ports LOGIC(A|B) are equipped on models with the /L16 option.

## Right Side Panel

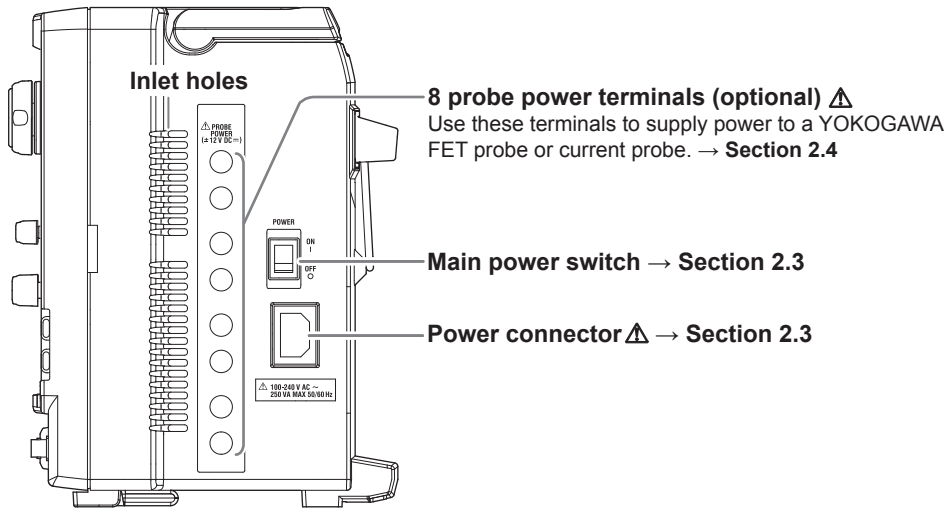

## Left Side Panel

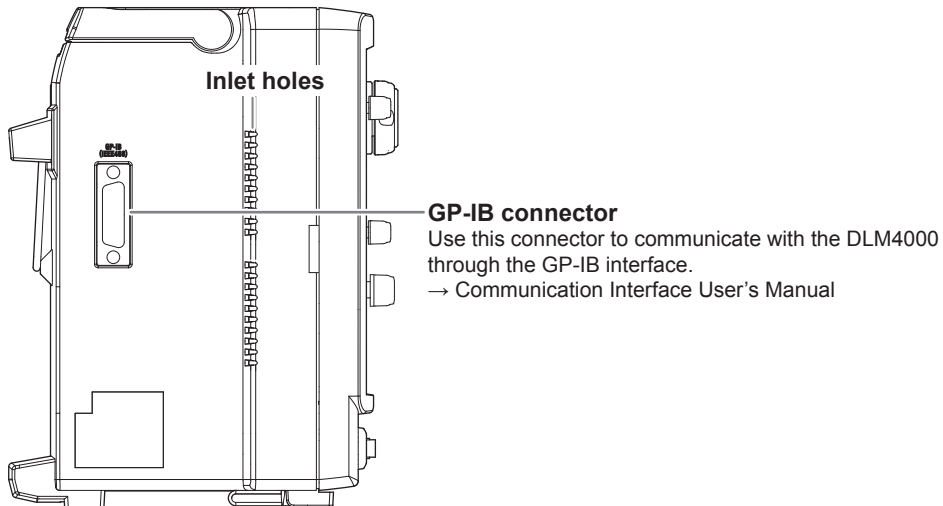

## Rear Panel

### Ethernet port

Use this port to connect the DLM4000 to a network.  
 → Features Guide and Communication Interface User's Manual

### USB port for PCs

Use this port to connect the DLM4000 to a PC that has a USB port.  
 → Communication Interface User's Manual

### Trigger output terminal $\Delta$

Use this terminal to transmit trigger signals. → Section 4.2

### External trigger input terminal $\Delta$

Use this terminal to apply external trigger signals. → Section 4.1

### Video signal output terminal $\Delta$

Use this terminal to view the DLM4000 display on an external display.  
 → Section 4.3

### GO/NO-GO output connector $\Delta$

This connector transmits GO/NO-GO result signals.  
 → Section 4.4

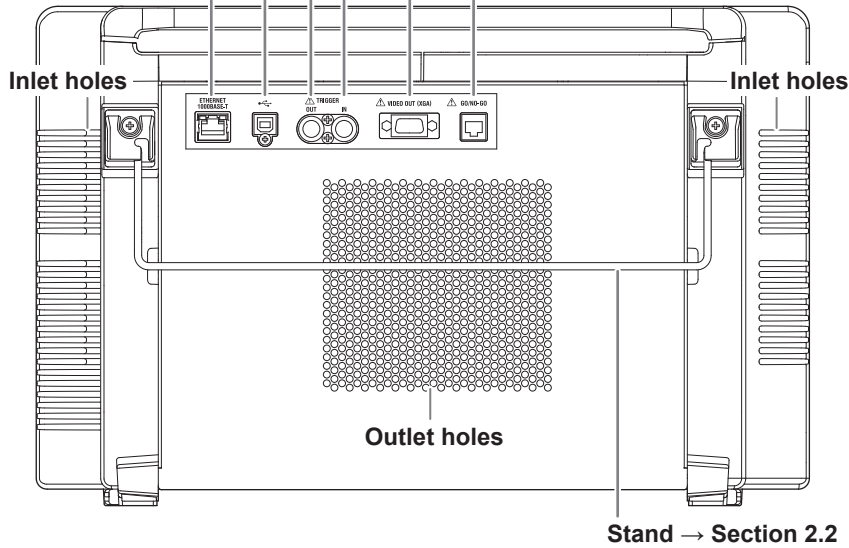

## 1.2 Keys and Knobs

### Vertical Axis

#### CH1 to CH8 Keys, L Key, and A|B Key (Option)

Display a menu for turning analog signal input channels on and off, for expanding and reducing the vertical axis, and for setting the vertical position, coupling, probe type, offset voltage, bandwidth limit, linear scaling, and waveform labels. Also, press any of these keys before pressing the SCALE or  $\blacklozenge$  POSITION knob to select which channel the SCALE knob will control. The LED between the SCALE and  $\blacklozenge$  POSITION knobs illuminates in the color assigned to the selected channel (the color around the CH key). Each CH key illuminates when its corresponding channel is being displayed.

Use the L key to configure the logic signal input port LOGIC(L). When you press the L key, it illuminates (and the CH8 key light turns off), and you can configure the LOGIC(L) port. When you press the CH8 key next to the L key, the CH8 key illuminates (and the L key light turns off), and you can configure the channel 8. The DLM4000 is designed so that you have to switch between setting channel 8 and the logic channel.

Use the A|B key (/L16 option) to configure the logic signal input ports LOGIC(A|B). When you press the A|B key, it illuminates, and you can configure the LOGIC(A|B) ports.

#### $\blacklozenge$ POSITION Knob (Vertical position knob)

Use the POSITION knob to move the display position (vertical position) of the input waveform along the vertical axis. Before you turn this knob, press a key from CH1 to CH8 (L) to specify the waveform whose position you want to adjust. This knob has a push switch. You can press the knob to reset the display position to 0.00 div. You can use this knob in the same manner when you press the L key or the A|B key (/L16 option).

#### SCALE Knob

Use this knob to set the vertical scale. Before you turn this knob, press a key from CH1 to CH8 (L) to specify the waveform whose position you want to adjust. If you change the scale while signal acquisition is stopped, the waveform is expanded or reduced vertically. If you restart signal acquisition, the DLM4000 acquires signals using the new vertical scale. This knob has a push switch. You can press the knob to switch the resolution. If you press the knob so that Fine illuminates, the resolution is set to fine mode.

When you press the L key or the A|B key (/L16 option), you can use this knob to change the vertical display size between three levels.

#### CH UTIL Key

Use this key to display or hide all input channels and ports, or to copy settings between analog signal input channels.

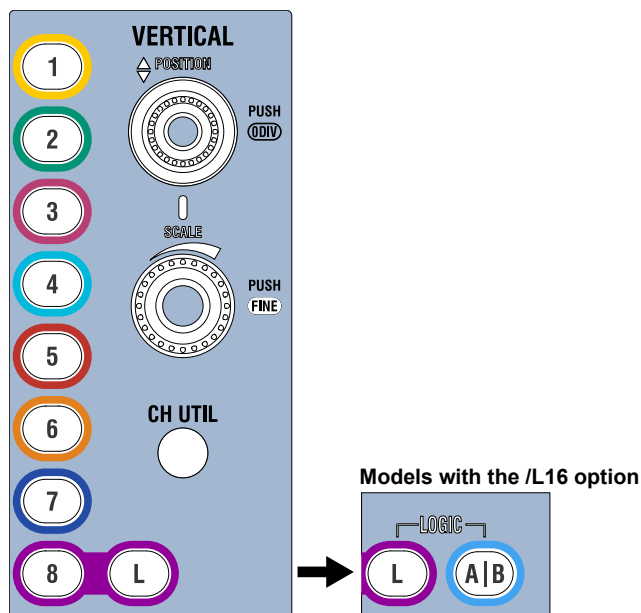

## Horizontal Axis

### ◀POSITION▶ Knob

Use this knob to move the trigger position. When you move the trigger position, the ratio of the displayed data before the trigger point (the pre-trigger section) and the data after the trigger point (the post-trigger point) changes. This knob has a push switch. You can press the knob to reset the trigger position to 50%.

### DELAY Key

When you press the DELAY key, the key illuminates. Then you can set the trigger delay using the ▶POSITION◀ knob.

You can reset the trigger delay to its default value (0 s) by pressing the ▶POSITION◀ knob when the DELAY key is illuminated.

### TIME/DIV Knob

Use this knob to set the time-axis scale. If you change the scale while signal acquisition is stopped, the waveform is expanded or reduced horizontally. If you restart signal acquisition, the DLM4000 acquires signals using the new time-axis scale.

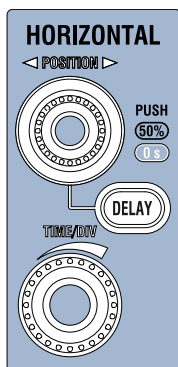

## Triggering

### EDGE Key

Displays a menu for setting the edge trigger. When you press this key, the edge trigger is selected, and the key illuminates.

### ENHANCED Key

Displays a menu for setting the enhanced trigger. When you press this key, the enhanced trigger is selected, and the key illuminates.

### MODE Key

Displays a menu for selecting the trigger mode.

### SHIFT+MODE (ACTION GO/NO-GO) Key

Press SHIFT and then press MODE to display an action-on-trigger menu or a GO/NO-GO menu.

### B TRIG Key

Use this key to set trigger combinations with the Edge or Enhanced trigger and to set the trigger B trigger type.

### SHIFT+B TRIG (FORCE TRIG) Key

Press SHIFT and then press B TRIG to force the DLM4000 to trigger even when trigger conditions are not met.

### LEVEL Knob

Use this knob to set the trigger level. This knob has a push switch. You can press the knob to automatically set the trigger level to the center of the waveform's amplitude (50% of the amplitude).

### TRIG'D Indicator

Illuminates when the DLM4000 triggers.

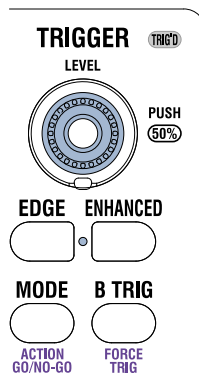

## Waveform Acquisition and Display

### AUTO SETUP Key

Automatically sets values that correspond to the input signal. UNDO appears in the menu, and you can undo the settings made with this key.

### DEFAULT SETUP Key

Restores each setting to its factory default value. UNDO appears in the menu, and you can undo the settings made with this key.

### ACQUIRE Key

Displays a menu for setting the signal acquisition mode.

### RUN/STOP Key

Starts and stops signal acquisition according to the trigger mode. The key illuminates while the DLM4000 is acquiring signals.

### SINGLE Key

Acquires one waveform. In Average mode, the DLM4000 acquires one waveform that has been obtained by linearly averaging waveforms for the specified number of times.

### DISPLAY Key

Displays a menu for configuring the display.

### SHIFT+DISPLAY (X-Y) Key

Press SHIFT and then press DISPLAY to display an X-Y display menu.

### HISTORY (↺↻) Key

Displays a menu for displaying and searching the history waveforms.

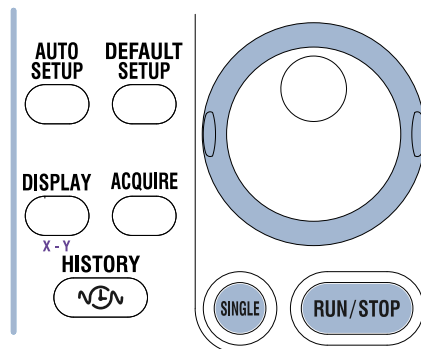



## Zoom, Search, and Serial Bus

### ZOOM1 and ZOOM2 Keys

Display a waveform zoom display menu. When a waveform zoom display is on, the corresponding key illuminates. If ZOOM1 and ZOOM2 are both on, the ZOOM knob controls the magnification of the zoom waveform whose corresponding key is illuminated brightly.

### ZOOM Knob

When a zoom display is on, you can turn this knob to set the magnification of the horizontal axis of the selected zoom display. Before turning this knob, press ZOOM1 or ZOOM2 to select the zoom waveform whose magnification you want to control. This knob has a push switch. If you press the knob so that Fine illuminates, the resolution is set to fine mode.

### SEARCH Key

Displays a waveform search menu.

### SHIFT+SEARCH (SERIAL BUS) Key

Press SHIFT and then press SEARCH to display a serial bus menu.

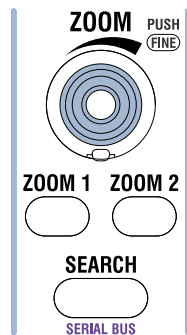

## Analysis

### CURSOR Key

Displays a menu for making cursor measurements.

### MEASURE Key

Displays a menu for automated measurement of waveform parameters and for statistical processing.

### ANALYSIS Key

Displays a waveform histogram display and an optional power supply analysis menu.

### MATH/REF Key

Use this key to configure waveform computation and reference waveforms.

### SHIFT+MATH/REF (FFT) Key

Press SHIFT and then press MATH/REF to display an FFT menu.

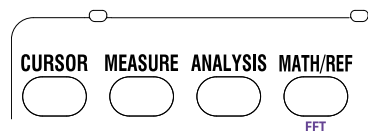

## Screen Capture Printing and Data Storage

### PRINT Key

Use this key to save and print screen capture data.

### SHIFT+PRINT (MENU) Key

Displays a menu for printing screen captures to the built-in printer or a network printer or displays a menu for saving screen capture data to a storage medium. There is an indicator next to the PRINT key that shows whether printing or storage is enabled.

### FILE Key

Displays a menu for saving various data to the internal memory and USB memory, loading data that you have saved, and performing other file-related tasks.

### UTILITY Key

Displays a menu for calibrating the DLM4000, connecting to a network or PC, running a self-test, and setting the date and time, menu language, message language, click sound, LCD backlight, offset cancel, and delay cancel.

You can also use this key to display system information (installed options and firmware version).

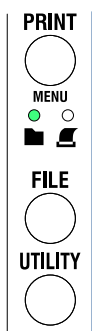

## Other Keys

### SNAP SHOT (📷) Key

Retains the currently displayed waveforms on the screen in white (by default).

### CLEAR TRACE (CLR) Key

Clears the displayed waveforms. If you execute a clear trace operation during waveform acquisition, the DLM4000 clears all the history waveforms that it has acquired and restarts waveform acquisition from the first acquisition.

### HELP (?) Key

Press this key to display and hide the help window, which explains various features.

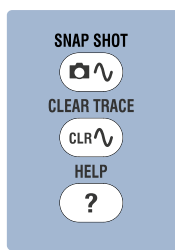

### SHIFT Key

Press this key once to illuminate it and access the features that are written in purple below each key. Press the key again to disable the shifted state.

### Jog Shuttle

When configuring various settings, use the jog shuttle to set values, move cursors, and select items. Turn the shuttle ring to vary the rate at which values change. The rate is set according to the shuttle ring angle.

### SET (●) Key

Press this key to enter the menu item that you selected using the jog shuttle.

If there are two items on the jog shuttle setup menu, you can press the key to change the item that the jog shuttle controls.

Move the SET key left and right to move the cursor between numeric digits.

Move the SET key up and down to increase and decrease a value. You can change the setting on a dialog menu by moving the key up, down, left, and right.

### RESET (⊘) Key

Resets an entered value to its default value.

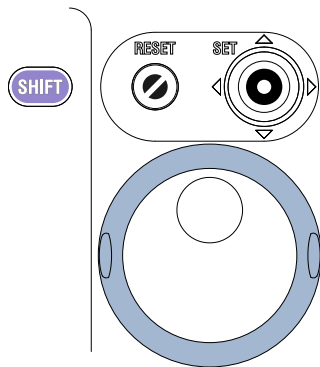

### Soft Keys

Use these keys to select items on the setup menus that appear during configuration.

### ESC Key

Use this key to close setup menus and dialog boxes and to return to the menu level above the current one.

## Notes about the Operation of Knobs with Push Switches

The following knobs have push switches: POSITION (vertical and horizontal), SCALE, LEVEL, and ZOOM. Push the knobs straight. If you push a knob at an angle, it may not operate properly. If this happens, push the knob straight one more time.

---

### CAUTION

---

Do not push a knob sideways with strong force. If you do, the knob may break.

---

### French

---

---

### ATTENTION

---

Ne pas enfoncer les boutons latéralement en employant une force excessive. Cela pourrait les endommager, voire les casser..

---

# 1.3 Screens

## Normal Analog Signal Waveform Screen

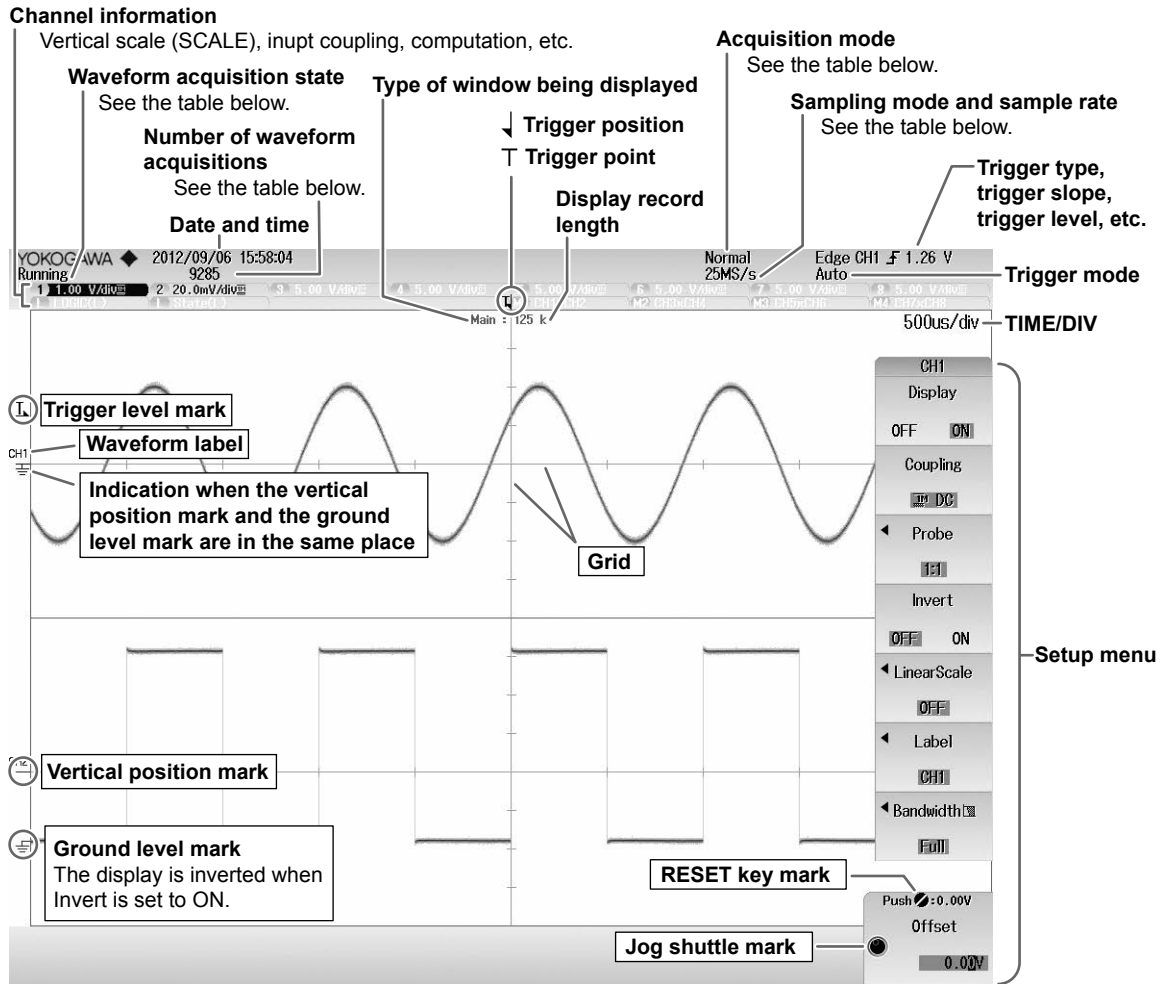

### Waveform Acquisition States

Stopped	Waveform acquisition is stopped.
Running	Waveform acquisition is taking place.
Preview	This state indication appears when waveform acquisition is stopped and a waveform acquisition condition such as the vertical scale (SCALE), time-axis scale (TIME/DIV), or trigger has been changed.

### Number of Waveform Acquisitions

Number	Indicates the number of waveform acquisitions. While the waveform acquisition state is "Running," the number increases up to the specified waveform acquisition count (ACQ Count).
Waiting for Trig.	The DLM4000 is waiting to trigger. This indication blinks.
Pre trig.	Data before the trigger point (the pre-trigger section) is being acquired.
Post trig.	Data after the trigger point (the post-trigger section) is being acquired.

### Acquisition Mode

Normal	Normal mode
Norm:Hi-Res	Normal mode with high resolution mode enabled
Envelope	Envelope mode. This indication is the same whether or not high resolution mode is enabled.
Average	Averaging mode
Avg:Hi-Res	Averaging mode with high resolution mode enabled

### Sampling Mode and Sample Rate

Number	Real-time sampling mode. Only the sample rate is displayed.
"IntP" and a number	Interpolation mode. The sample rate is displayed after "IntP."
"Rep" and a number	Repetitive sampling mode. The sample rate is displayed after "Rep."

## Logic Signal Waveform Screen

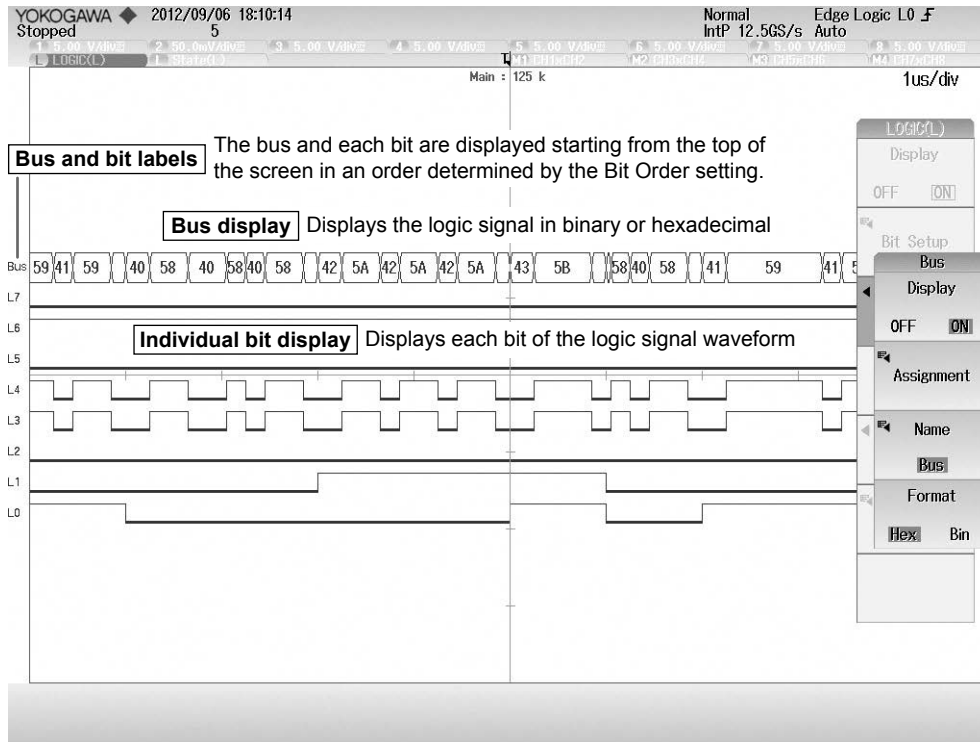

## Screen Displaying Zoom Waveforms

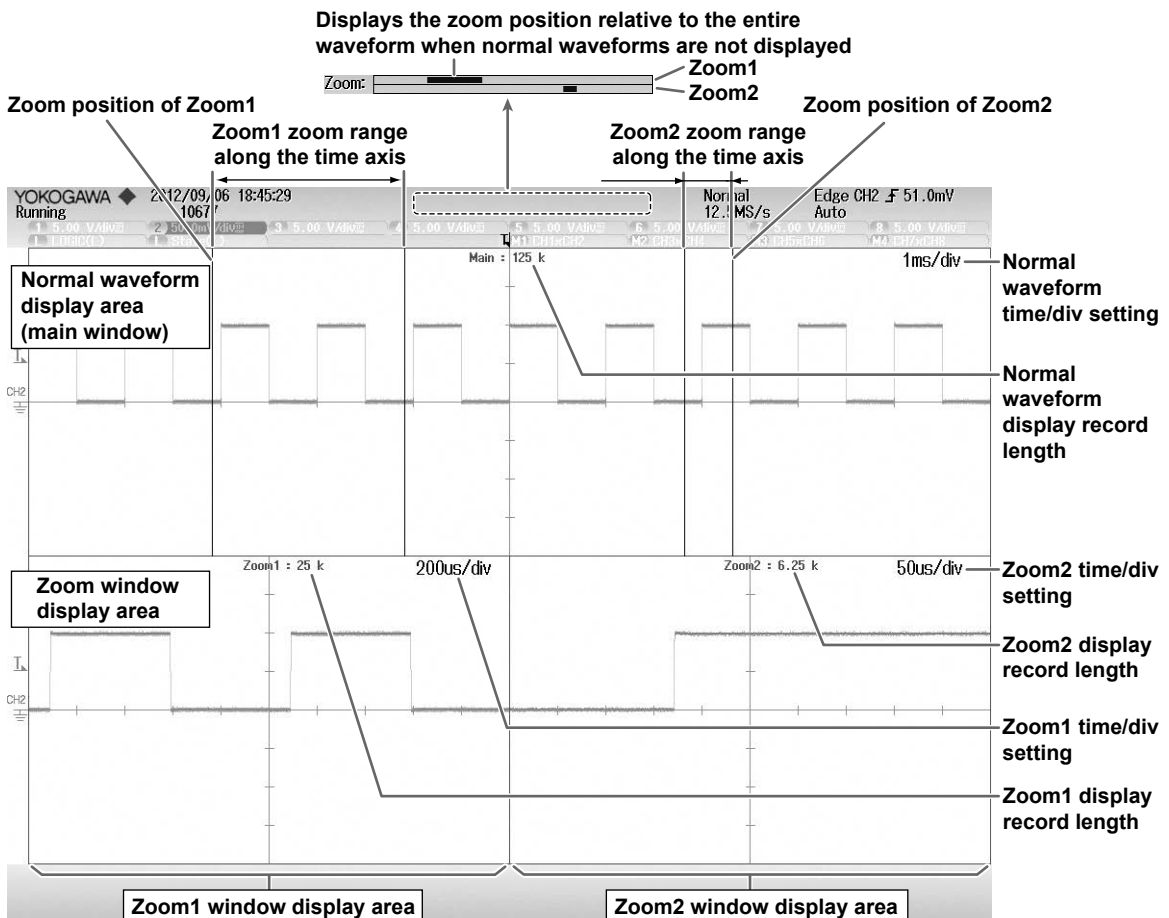

## Screen Displaying Analysis Results

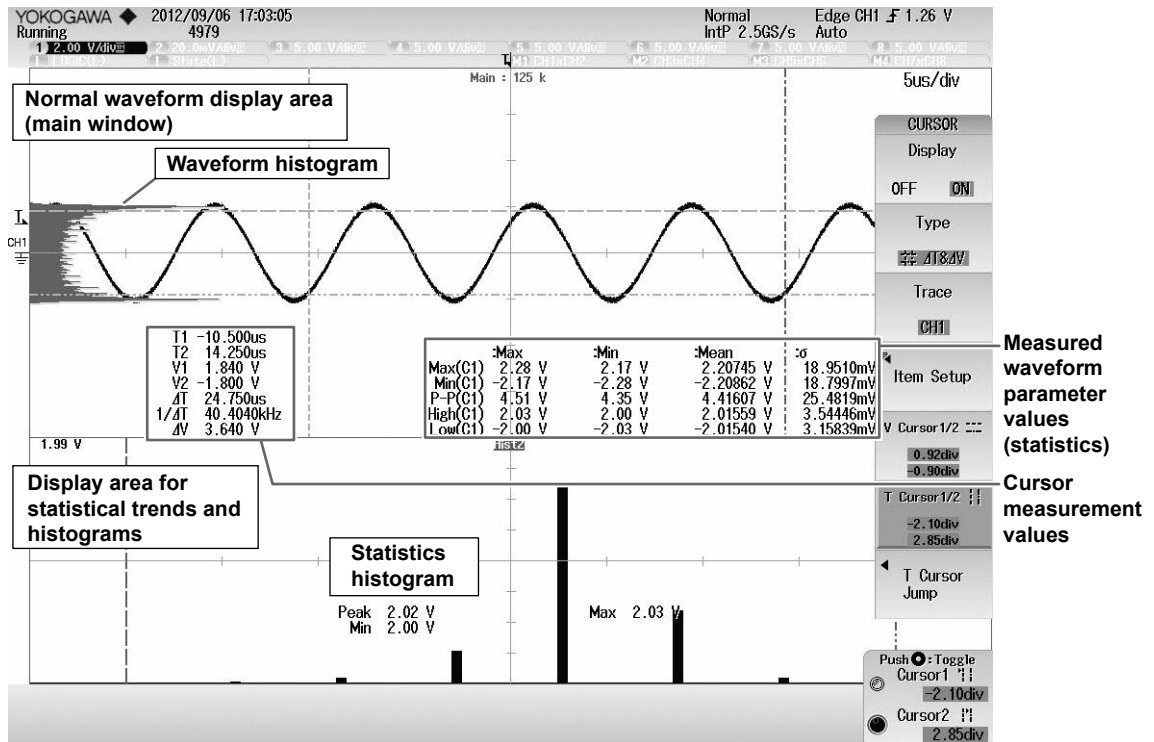

If the setup menu is not displayed, the area at the bottom of the screen (the area outside of the waveform and measured value display areas) shows measured waveform parameter values or cursor measurement values.

## 2.1 Handling Precautions

### Safety Precautions

If you are using this instrument for the first time, make sure to read “Safety Precautions” on pages viii to xi.

#### Do Not Remove the Case

Do not remove the case from the instrument. Some parts of the instrument use high voltages and are extremely dangerous. For internal inspection and adjustment, contact your nearest YOKOGAWA dealer.

#### Unplug If Abnormal Behavior Occurs

If you notice smoke or unusual odors coming from the instrument, immediately turn off the power and unplug the power cord. Then, contact your nearest YOKOGAWA dealer.

#### Do Not Damage the Power Cord

Nothing should be placed on top of the power cord, and it should be kept away from any heat sources. When removing the plug from the power outlet, do not pull on the cord. Pull from the plug. If the power cord is damaged or if you are using the instrument in a location where the power supply specifications are different, purchase a power cord that matches the specifications of the region that the instrument will be used in.

#### Operating Environment and Conditions

This instrument complies with the EMC standard under specific operating environment and operating conditions. If the installation, wiring, and so on are not appropriate, the compliance conditions of the EMC standard may not be met. In such cases, the user will be required to take appropriate measures.

### General Handling Precautions

#### Do Not Place Objects on Top of the Instrument

Never place objects such as other instruments or objects that contain water on top of the instrument. Doing so may damage the instrument.

#### Do Not Subject the Inputs to Mechanical Shock

Applying shock to the input connectors, probes, etc., can cause electrical noise to enter the instrument through the signal lines.

#### Do Not Damage the LCD

Because the LCD is very vulnerable and can be easily scratched, do not allow any sharp objects near it. Also, the LCD should not be exposed to vibrations or shocks.

#### Unplug during Extended Non-Use

Unplug the power cord from the outlet.

## 2.1 Handling Precautions

---

### When Carrying the Instrument

Remove the power cord and connecting cables. When carrying the instrument, either hold the handle or hold the instrument with both hands as shown in the figure below.

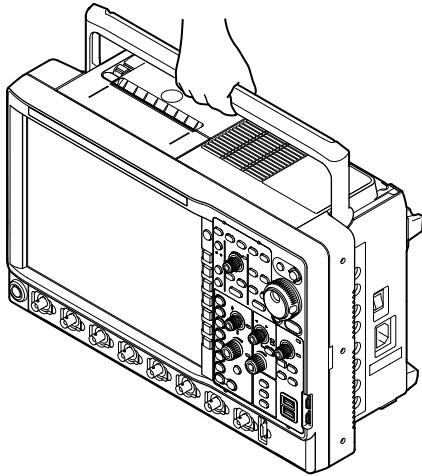

---

#### WARNING

- When you hold or put away the handle, be careful not to get your hand caught between the handle and the case.
  - When you carry the instrument, be careful not to get your hand caught between the wall, installation surface, or other objects and the instrument.
- 

#### French

---

#### AVERTISSEMENT

- Lorsque vous attrapez ou rabattez la poignée, veillez à ne pas vous coincer la main entre la poignée et l'instrument.
  - Lorsque vous déplacez l'instrument, veillez à ne pas vous coincer la main entre l'instrument et le mur, la surface d'installation ou tout autre objet.
- 

### When Cleaning the Instrument

When cleaning the case or the operation panel, first remove the power cord from the outlet, and then wipe with a dry, soft, clean cloth. Do not use chemicals such as benzene or thinner. Doing so may cause discoloring and deformation.



## 2.2 Installing the Instrument

### WARNING

- Do not install the instrument outdoors or in locations subject to rain or water.
- Install the instrument so that you can immediately remove the power cord if an abnormal or dangerous condition occurs.

### CAUTION

If you block the inlet or outlet holes on the DLM4000, the DLM4000 will become hot and may break down.

### French

### AVERTISSEMENT

- Ne pas installer l'instrument à l'extérieur ou dans des lieux exposés à la pluie ou à l'eau.
- Installer l'instrument de manière à pouvoir immédiatement le débrancher du secteur en cas de fonctionnement anormal ou dangereux.

### ATTENTION

Ne pas boucher les orifices d'entrée ou de sortie du DLM4000 pour éviter toute surchauffe et panne éventuelle.

## Installation Conditions

Install the instrument in a place that meets the following conditions.

### Flat, Even Surface

Install the instrument with the correct orientation on a stable, horizontal surface (see page 2-5). The printing quality may be hindered when the instrument is placed in an unstable or inclined place.

## 2.2 Installing the Instrument

### Well-Ventilated Location

Inlet holes are located on the top panel and the left and right side panels of the instrument. In addition, there are outlet holes for the cooling fan on the rear panel. To prevent internal overheating, allow for enough space around the instrument (see the figure below), and do not block the inlet and outlet holes.

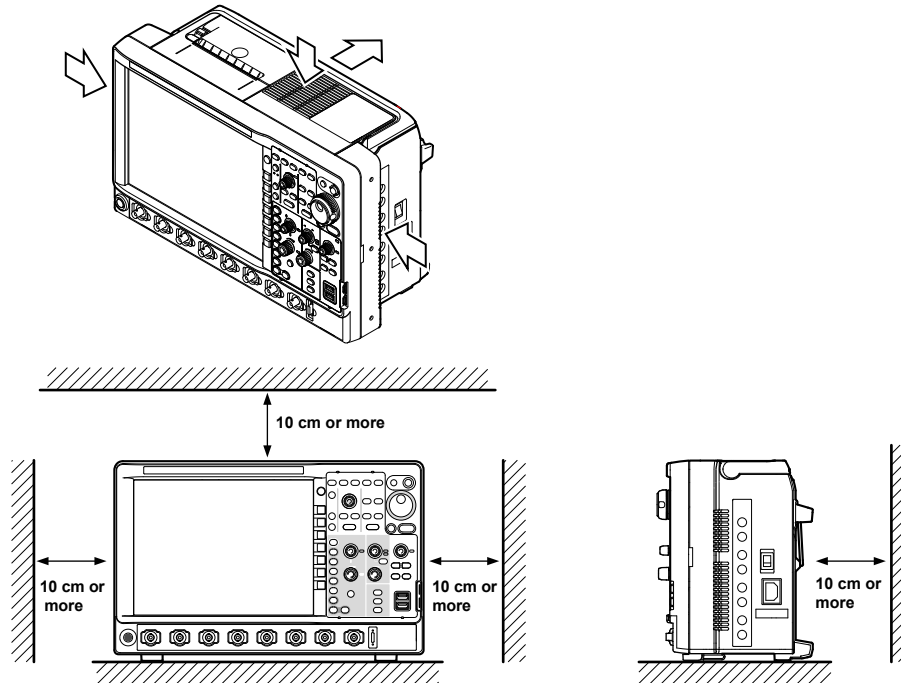

When connecting cables, allow for enough space, beyond the space shown in the figure above, to carry out the procedure.

### Ambient Temperature and Humidity

Use the instrument in the following environment.

Ambient temperature	5°C to 40°C
Ambient humidity	20 to 80%RH when the printer is not used. (No condensation)
	35 to 80%RH when using the printer. (No condensation)

#### Note

- To ensure high measurement accuracy, operate the instrument within the following ranges:  $23 \pm 5^\circ\text{C}$  and  $55 \pm 10\%\text{RH}$ .
- Condensation may occur if the instrument is moved to another place where the ambient temperature or humidity is higher, or if the temperature changes rapidly. In such cases, before you use the instrument, allow it to adjust to the surrounding temperature for at least an hour.

### Do Not Install the Instrument in the Following Places.

- In direct sunlight or near heat sources
- In an environment with excessive amounts of soot, steam, dust, or corrosive gas
- Near strong magnetic field sources
- Near high-voltage equipment or power lines
- In an environment that is subject to large levels of mechanical vibration
- On an unstable surface
- Outdoors or in locations subject to rain or water

## Installation Position

Place the instrument in a horizontal position or tilt it on its movable legs or stand. When you use the movable legs or stand, push out until the legs or stand locks. To put away the stand, push it inward while returning it to its original position.

Horizontal installation

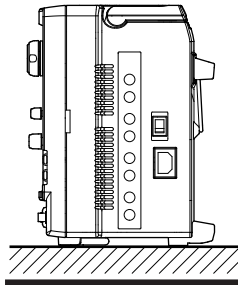

Tilted installation

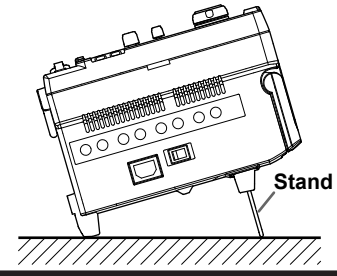
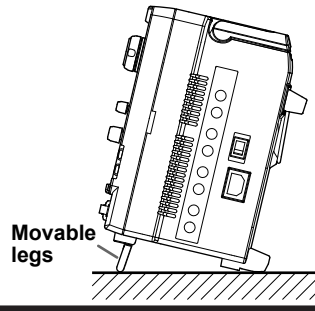

### WARNING

- When you handle the movable legs, be careful not to injure your hand with the leg edges.
- When you put away the movable legs or stand, be careful not to get your hand caught between the movable legs or stand and the instrument.
- Handling the movable legs or stand without firmly supporting the instrument can be dangerous. Please take the following precautions.
  - Only handle the movable legs or stand when the instrument is on a stable surface.
  - Do not handle the movable legs or stand when the instrument is tilted.
- Do not place the instrument in any position other than those shown in the above figures. Also, do not stack the instrument.

### French

### AVERTISSEMENT

- Lorsque vous manipulez les pieds escamotables, veillez à ne pas vous blesser la main.
- Lorsque vous rangez les pieds ou le support escamotable, veillez à ne pas vous coincer la main entre l'instrument et les pieds ou le support.
- Lorsque vous manipulez les pieds ou le support escamotable, soutenez toujours l'instrument fermement. Prendre les précautions suivantes.
  - Ne manipuler les pieds ou le support escamotable que lorsque l'instrument est placé sur une surface stable.
  - Ne pas manipuler les pieds ou le support escamotable lorsque l'instrument est incliné.
- Ne pas placer l'instrument dans des positions autres celles indiquées ci-dessus. Ne pas empiler l'instrument.

## Rubber Feet

You can attach rubber feet to the feet at the bottom of the instrument for when you use the instrument in the first and second Installation positions from the left that are shown on the previous page. One set of feet (four feet) comes with the instrument as a standard accessory.

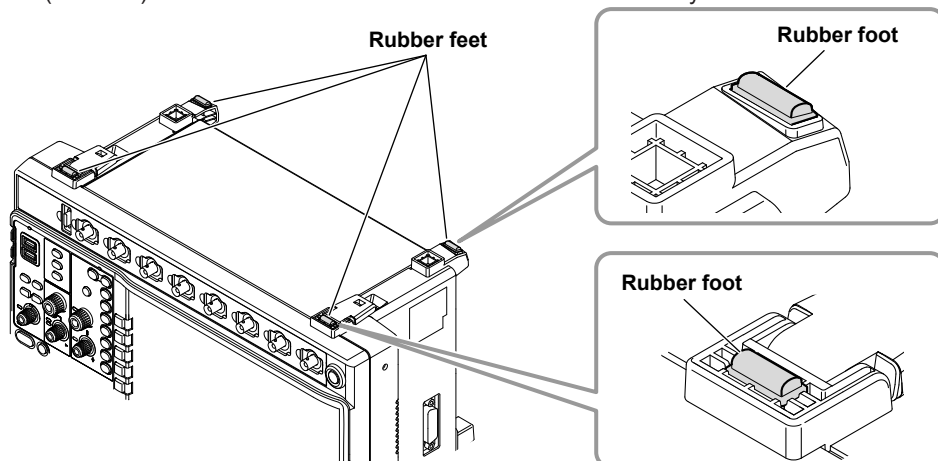

## 2.3 Connecting the Power Supply and Turning the Power Switch On and Off

### Before Connecting the Power Supply

Make sure to follow the warnings below when connecting the power supply. Failure to do so may cause electric shock or damage to the instrument.



#### WARNING

- Make sure that the power supply voltage matches the instrument's rated supply voltage and that it does not exceed the maximum voltage range of the power cord to use.
- Connect the power cord after checking that the main power switch of the instrument is turned off.
- To prevent electric shock or fire, use the power cord for the instrument.
- Make sure to connect protective earth grounding to prevent electric shock. Connect the power cord to a three-prong power outlet with a protective earth terminal.
- Do not use an ungrounded extension cord. If you do, the instrument will not be grounded.
- If there is no AC outlet that is compatible with the power cord that you will be using and you cannot ground the instrument, do not use the instrument.

#### French



#### AVERTISSEMENT

- Assurez-vous que la tension d'alimentation correspond à la tension d'alimentation nominale de l'appareil et qu'elle ne dépasse pas la plage de tension maximale du cordon d'alimentation à utiliser.
- Brancher le cordon d'alimentation après avoir vérifié que l'interrupteur d'alimentation principal de l'instrument est sur OFF.
- Pour éviter tout risque de choc électrique, utiliser exclusivement le cordon d'alimentation prévu pour cet instrument.
- Relier l'instrument à la terre pour éviter tout risque de choc électrique. Brancher le cordon d'alimentation sur une prise de courant à trois plots reliée à la terre.
- Toujours utiliser une rallonge avec broche de mise à la terre, à défaut de quoi l'instrument ne serait pas relié à la terre.
- Si une sortie CA conforme au câble d'alimentation fourni n'est pas disponible et que vous ne pouvez pas relier l'instrument à la terre, ne l'utilisez pas.

### Connecting the Power Cord

1. Check that the main power switch on the right side panel of the instrument is turned off.
2. Connect the power cord plug to the power connector on the right side panel.
3. Connect the other end of the cord to an outlet that meets the following conditions. Use a grounded three-prong outlet.

Item	
Rated supply voltage*	100 VAC to 240 VAC
Permitted supply voltage range	90 VAC to 264 VAC
Rated power supply frequency	50/60 Hz
Permitted supply frequency range	48 Hz to 63 Hz
Maximum power consumption	Approx. 250 VA

\* This instrument can use a 100 V or a 200 V power supply. The maximum rated voltage differs according to the type of power cord. Check that the voltage supplied to the instrument is less than or equal to the maximum rated voltage of the power cord that you will be using before use.

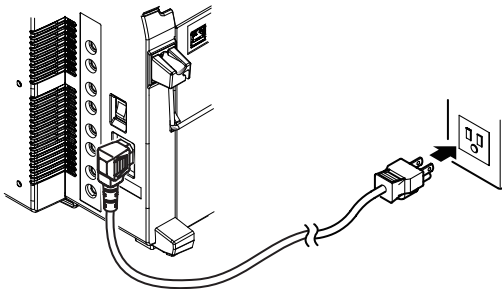

## Turning the Instrument On

### Before Turning On the Power, Check That:

- The instrument is installed properly → Section 2.2, “Installing the Instrument”
- The power cord is connected properly → Previous page

### Turning On the Main Power Switch

1. Flip the power switch on the right side panel to the ON ( | ) position.

The front-panel power switch illuminates in red-orange.

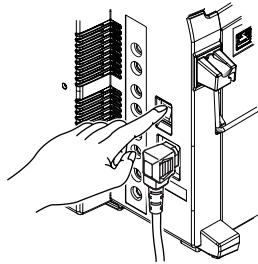

### Turning On the Power Switch

2. Press the power switch on the front panel.

The power switch color will change from red-orange to green.

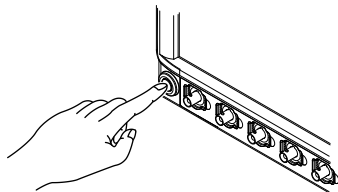

#### Note

If you turn off the main power switch while the front-panel power switch is turned on (while the power switch is illuminated in green), you can start the instrument the next time by simply turning on the main power switch. However, if you turn off the main power switch while the front-panel power switch is turned on, the setup data immediately before the power switch is turned off will not be stored properly.

## Operations Performed When the Power Is Turned On

When the power switch is turned on, a self-test and calibration start automatically. When the DLM4000 starts normally, the waveform display screen appears. Check that the DLM4000 has started normally before you use it.

### If the DLM4000 Does Not Start Normally When the Power Is Turned On

Turn off the power switch, and check the following items.

- Check that the power cord is securely connected.
- Check that the correct voltage is coming to the power outlet. → Page 2-6
- Initialize the settings to their factory defaults by turning on the power switch while holding down the RESET key.

If the instrument still does not work properly, contact your nearest YOKOGAWA dealer for repairs.

#### Note

- After turning the power switch off, wait at least 10 seconds before you turn it on again.
- It takes approximately 10 seconds for the startup screen to appear.

### Turning the Instrument Off

---

#### CAUTION

Abruptly turning off the main power switch or unplugging the power cord while data is being saved or the internal printer is printing may corrupt the media on which data is being saved or damage the built-in printer. Also, the data being saved is not guaranteed. Always turn the main power switch off after data has been saved.

---

#### French

---

#### ATTENTION

Mettre brutalement l'instrument hors tension ou débrancher le cordon d'alimentation pendant l'enregistrement de données ou le fonctionnement de l'imprimante interne peut corrompre le support d'enregistrement des données ou endommager l'imprimante intégrée. Les données en cours d'enregistrement pourront également être perdues. Toujours mettre l'instrument hors tension après que les données ont été enregistrées.

---

### Turning Off the Power Switch

1. Press the power switch on the front panel.

### Turning Off the Main Power Switch

2. Check that the front-panel power switch changes from green to red-orange, and then flip the power switch on the right side panel to the OFF (○) position.

### Operations Performed When the Power Is Turned Off

The settings immediately before the power switch is turned off are stored. Therefore, the next time the power is turned on, waveforms are measured using those settings.

#### Note

---

If you turn off the main power switch on the right side panel while the power switch on the front panel is turned on, the setup data immediately before the power switch is turned off will not be stored properly. The next time you turn on the main power switch, the front-panel power switch automatically turns on, and the instrument starts using the previous settings that were stored properly. When this occurs, a message appears on the screen, but it does not mean that the instrument is broken. When turning the power off, turn off the power switch on the front panel, and then turn off the main power switch on the right side panel.

---

### To Make Accurate Measurements

- Allow the instrument to warm up for at least 30 minutes after turning on the power switch.
- After the instrument has warmed up, perform calibration.
- If auto calibration is set to ON, the DLM4000 will automatically perform calibration when you perform one of the operations below if the following times have passed since the power was turned on.
  - 3 minutes, 10 minutes, 30 minutes, 1 hour, and each following hour
- When you change time/div during waveform acquisition (when the RUN/STOP key is illuminated)
- When you start waveform acquisition after stopping waveform acquisition (so that the RUN/STOP key is not illuminated)

#### **Note**

---

If calibration is executed while signals are being applied to the DLM4000, we recommend that you stop signal application and recalibrate the DLM4000.

---

- Adjust the vertical scale using the SCALE knob so that the input waveform fits within the effective data range. The effective data range is  $\pm 5$  div from the center of the main window. If this range is exceeded, proper measurements may not be possible.

## 2.4 Connecting Probes



### WARNING

- Always turn off the power of the device under measurement before connecting the device under measurement to the instrument. It is extremely dangerous to connect or disconnect a measuring lead while the device under measurement is on.
  - Do not apply an input voltage that exceeds the maximum input voltage, withstand voltage, or allowable surge voltage.
  - To avoid electric shock, be sure to ground the instrument, and connect the ground of the probe and input connector to the ground of the item being measured.
  - Avoid continuous connections in environments in which a voltage surge may occur.
  - If over-range is indicated, the DLM4000 may be receiving a voltage higher than the observed waveform or measured waveform values.\* To prevent electric shock, change the vertical scale with the SCALE knob so that the entire amplitude of the waveform is displayed within the waveform display area, and check the input voltage level.
- \* If the input coupling is set to AC, the over-range indicator may not be displayed. For details, see section 1.1, "Setting the Input Coupling," in the user's manual, IM DLM4038-02EN.

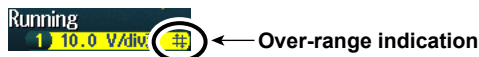

### CAUTION

- The probe interface terminals are located near the input terminals on this instrument. Do not short the probe interface terminals. When you connect a probe, make sure to prevent an excessive voltage caused by static electricity, etc., from being applied to the probe interface terminal, as this may damage the terminal.
- The maximum input voltage for 1 M $\Omega$  input is 150 Vrms when the frequency is less than or equal to 1 kHz. Applying a greater voltage may damage the input section. For frequencies above 1 kHz, damage may occur even if the voltage is less than 150 Vrms.
- The maximum input voltage for 50  $\Omega$  input is 5 Vrms or 10 Vpeak. Applying a voltage greater than either of these limits may damage the input section.
- For information about how to handle a probe, refer to the user's manual that came with the probe.



## French

**AVERTISSEMENT**

- Toujours mettre l'appareil à mesurer hors tension avant de le brancher sur l'instrument. Il est extrêmement dangereux de brancher un câble de mesure lorsque l'appareil à mesurer est sous tension.
  - Ne pas dépasser les valeurs maximales de tension d'entrée, de tension de maintien ou de surtension admissible.
  - Pour éviter tout risque de choc électrique, relier l'instrument à la terre et brancher la terre de la sonde et du connecteur d'entrée sur la terre de l'appareil à mesurer.
  - Éviter les connexions continues dans les environnements pouvant être soumis à surtension.
  - En cas de dépassement, le DLM4000 risque de recevoir une tension supérieure à la forme d'onde observée ou aux valeurs de forme d'onde mesurées.\* Pour éviter tout risque de choc électrique, modifier l'échelle de gain vertical à l'aide du bouton SCALE, de sorte que l'amplitude entière de la forme d'onde s'affiche sur l'afficheur, et vérifier le niveau de tension d'entrée.
- \* Si le couplage d'entrée est réglé sur courant alternatif (CA), l'indicateur de dépassement de plage risque de ne pas s'afficher. Pour en savoir plus, voir la section 1.1 « Setting the Input Coupling » dans le manuel d'utilisation IM DLM4038-02EN.



← Dépassement de plage

**ATTENTION**

- Sur cet instrument, les bornes d'interface de sonde se situent à proximité des bornes d'entrée. Ne pas court-circuiter les bornes d'interface de sonde. Lors du branchement d'une sonde, éviter qu'une tension excessive, causée entre autre par l'électricité statique, ne soit appliquée sur la borne d'interface de sonde, car cela pourrait l'endommager.
- La tension d'entrée maximale pour une entrée de 1 M $\Omega$  est de 150 Vrms lorsque la fréquence est inférieure ou égale à 1 kHz. L'application d'une tension supérieure pourrait endommager la section d'entrée. Si la fréquence est supérieure à 1 kHz, une tension inférieure à 150 Vrms pourra tout de même endommager la section d'entrée.
- La tension d'entrée maximale pour une entrée de 50  $\Omega$  est de 5 Vrms ou 10 Vcrête. L'application d'une tension supérieure à l'une de ces limites pourrait endommager la section d'entrée.
- Pour toute information sur la manipulation de la sonde, se reporter au manuel d'utilisation fourni avec la sonde.

## Connecting Probes

Connect probes (or input cables such as BNC cables) to the input terminals on the bottom of the front panel. The input impedance is  $1\text{ M}\Omega \pm 1.0\%$  and approximately  $20\text{ pF}$  parallel or  $50\ \Omega \pm 1.0\%$ .

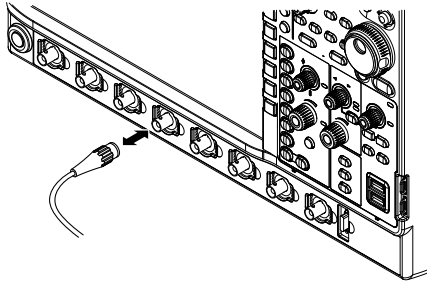

## Precautions to Be Taken When Connecting Cables

- When connecting a probe to the instrument for the first time, perform phase correction of the probe as described in section 2.5, “Correcting a Probe Phase.” If you don’t correct the probe phase, the frequency characteristics will not be flat, and measurements will not be correct. Perform phase correction on each channel to which a probe is to be connected.
- Please note that if the circuit being measured is directly connected to the instrument without the use of a probe, correct measurements may not be possible because of the effect of the input impedance of the instrument.

## About Probes

### Specifications, after Probe Phase Compensation, of the Standard Accessory Probe (model 701939)

For details, see the manual that came with the probe.

Item	Specification
Length of probe and cable	1.3 m
Input impedance	$10\text{ M}\Omega \pm 2\%$
Input capacitance	Approx. $10.5\text{ pF}$
Attenuation ratio	$10:1 \pm 2\%$
Bandwidth	DC to 500 MHz (not exceeding $-3\text{ dB}$ )
Rise time	$700\text{ ps}$ or less (typical*)
Maximum input voltage	$600\text{ V}$ (DC + AC <sub>peak</sub> ) or $424\text{ V}_{\text{rms}}$

\* Typical values represent typical or average values. They are not strictly warranted.

### Specifications, after Probe Phase Compensation, of the Optional Accessory Probe (model 701946)

For details, see the manual that came with the probe.

Item	Specification
Length of probe and cable	1.3 m
Input impedance	$10\text{ M}\Omega \pm 1\%$
Input capacitance	Approx. $9.5\text{ pF}$
Attenuation ratio	$10:1 \pm 2\%$
Bandwidth	DC to 500 MHz (not exceeding $-3\text{ dB}$ )
Rise time	$700\text{ ps}$ or less (typical*)
Maximum input voltage	$400\text{ V}_{\text{rms}}$

\* Typical values represent typical or average values. They are not strictly warranted.

## Precautions to Be Taken When Using Voltage Probes Other Than Those Provided with the Instrument

- When measuring a signal that includes a frequency close to 500 MHz, use a probe with a frequency range above 500 MHz.
- Measurement will only be correct if the attenuation ratio is set properly. Check the attenuation ratio of the probe that you are using and set it properly.

## Setting the Probe Attenuation Ratio or the Voltage-Current Conversion Factor

When using a probe not supported by the probe interface connectors, set the instrument's attenuation ratio or voltage-current conversion factor to match the probe attenuation ratio or voltage-current conversion factor. If the instrument's settings do not match the probe specifications, correct measurement values will not be displayed.

## Connecting a Probe Supported by the Probe Interface Connectors

- If you connect a probe supported by the probe interface connector to the instrument, the probe type is automatically recognized, and the attenuation ratio set.\* Also because power is supplied to the probe through the probe interface, it is not necessary to connect the probe power cable to the probe power terminals.
- You can execute automatic zero adjustment on a current probe that is compatible with the probe interface connector.

\* For a list of compatible probes, see "Optional Accessories" on page vi.

## Connecting an FET Probe, Current Probe, Differential Probe, or Deskew Correction Signal Source

If you are using a YOKOGAWA FET probe, current probe, differential probe, or deskew correction signal source, use one of the probe power terminals (option) on the instrument's right side panel as the power supply.\* For details on the connection procedure, see the manual that came with the product that you want to use.

\* For a list of probe and signal source models, see "Optional Accessories" on page vi.



### CAUTION

Do not use the probe power terminals (option) on the instrument's right side panel for purposes other than supplying power to an FET probe, current probe, differential probe, or deskew correction signal source. Also, be sure that the total current of the eight probe power terminals and the eight probe interface terminals does not exceed 2.0 A for  $\pm 12$  V or 1.6 A for  $\pm 5$  V. Otherwise, the instrument or a device connected to the probe power terminals may break.

### French



### ATTENTION

Ne pas utiliser les bornes d'alimentation de sonde (option) sur le volet droit de l'instrument à d'autres fins que l'alimentation de la sonde FET, sonde de courant, sonde différentielle ou source de signal de correction Deskew. Vérifier également que le courant total des huit bornes d'alimentation de sonde et des huit bornes d'interface de sonde ne dépasse pas 2,0 A pour  $\pm 12$  V ou 1,6 A pour  $\pm 5$  V, car cela aurait pour effet d'endommager l'instrument ou l'appareil connecté aux bornes d'alimentation de sonde.

## Handling Precautions for the Probe Interface Terminals and Probe Power Terminals

If you are connecting a YOKOGAWA FET probe, current probe, differential probe, or deskew correction signal source to one of the probe power terminals (option) on the right side panel, be sure that the total current of the eight probe power terminals and the eight probe interface terminals does not exceed 2.0 A for  $\pm 12$  V or 1.6 A for  $\pm 5$  V. Otherwise, the instrument's operation may become unstable as a result of the activation of the excessive current protection circuit of the power supply.

- The number of current probes (701932/701933) that can be used is limited by the measured current (the current measured by the current probes). The characteristics of measured current versus current consumption for the active probes that can be connected to the instrument are as follows.

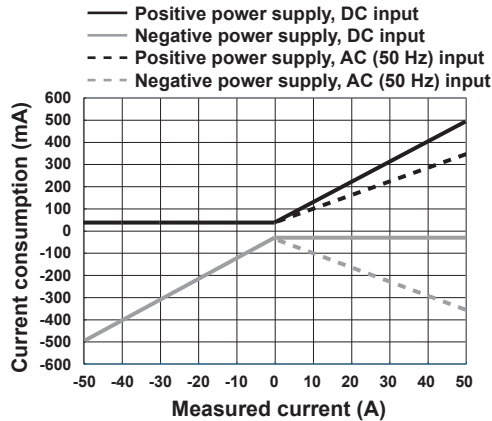

Measured current and current consumption of the 701928 current probe (example of characteristics)

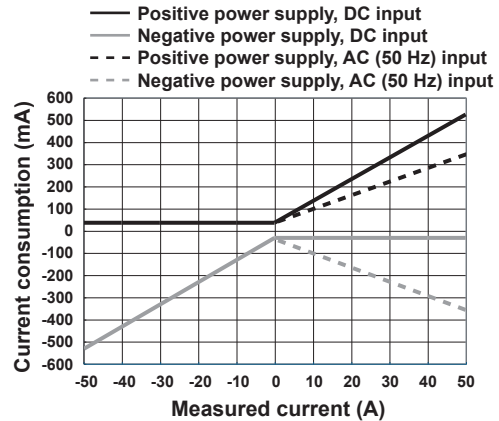

Measured current and current consumption of the 701929 current probe (example of characteristics)

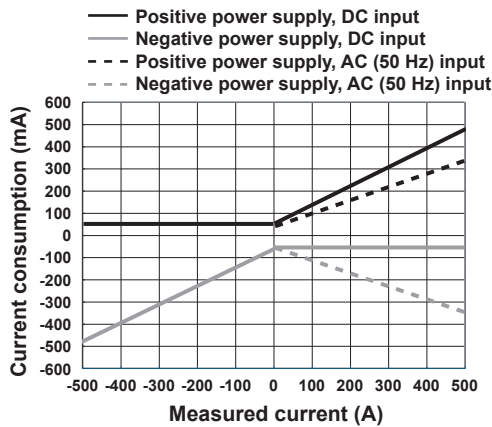

Measured current and current consumption of the 701931 current probe (example of characteristics)

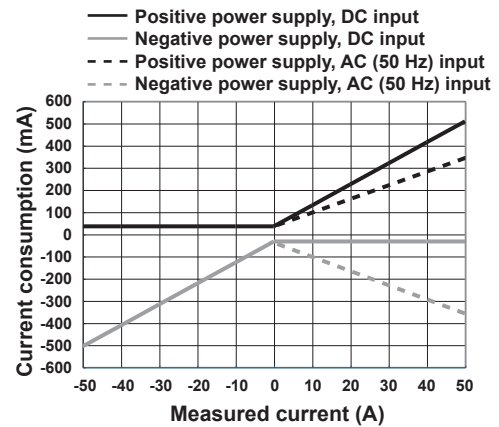

Measured current and current consumption of the 701932/701933 current probe (example of characteristics)

- In calculations, take the maximum current consumption of an FET probe (700939) or differential probe (700924, 700925, 701920, 701921, 701922, or 701926) to be 125 mA for both negative and positive voltages. Take the maximum current consumption of a differential probe (701927) to be 50 mA for both negative and positive voltages.

## 2.5 Correcting a Probe Phase

Before using a probe to make measurements, be sure to correct the probe phase.



### CAUTION

Do not apply external voltage to the signal output terminal for probe compensation adjustment. Doing so may damage the internal circuitry.

#### French



### ATTENTION

Ne pas appliquer de tension externe sur la borne de sortie de signal afin d'ajuster la compensation de sonde. Cela pourrait endommager le circuit interne.

### Procedure

1. Turn on the power switch.
2. Connect the probe to the input terminal to which the signal is to be applied.
3. Connect the tip of the probe to the signal output terminal for probe compensation adjustment on the front panel of the instrument and connect the ground wire to the functional ground terminal.
4. Perform auto setup according to the procedures given in section 3.5, "Performing Auto Setup."
5. Insert a flat-head screwdriver into the phase adjustment hole and turn the variable capacitor to make the displayed waveform a correct rectangular wave.

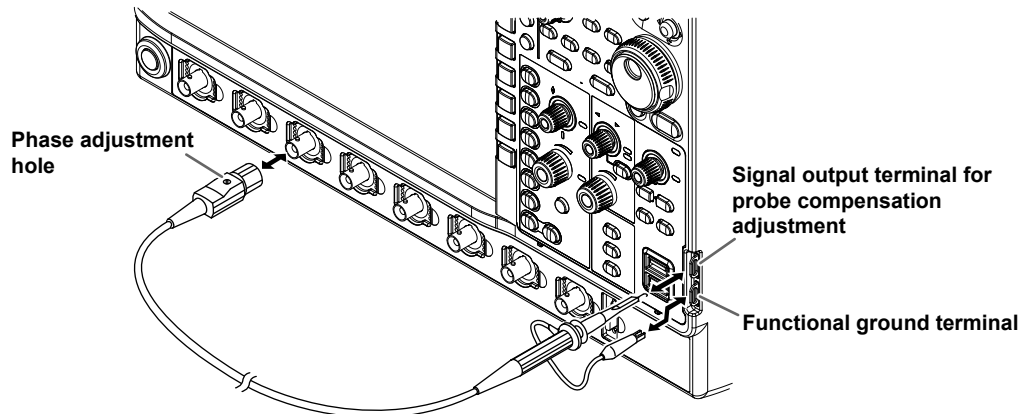

**Explanation**

**Necessity of Probe Phase Correction**

The phase of each probe is already corrected so as to approximately match the input capacitance of the oscilloscope that the probe is intended to be used with. However, the input resistance and input capacitance each of the input channels of each individual oscilloscope vary. This results in a mismatch in the voltage divider ratio between low and high frequency signals and causes uneven frequency characteristics.

There is a variable capacitor for adjusting the division ratio (trimmer) for high frequency signals on the probe. To correct the phase, you must adjust this trimmer so that flat frequency characteristics are obtained.

Be sure to correct the phase of a probe that you are using for the first time.

Because the input capacitance varies on each channel, probe compensation is always required when the probe is switched from one channel to another.

**Phase Compensation Signal**

The following square wave signal is output from the signal output terminal for probe compensation adjustment.

Frequency: Approx. 1 kHz

Amplitude: Approx. 1 V

**Differences in the Waveform Caused by the Phase Correction of the Probe**

Correct waveform

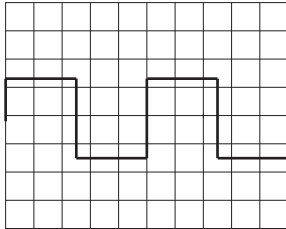

Overcompensated (The gain in the high frequency region is too high.)

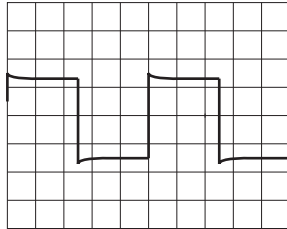

Undercompensated (The gain in the high frequency region is too low.)

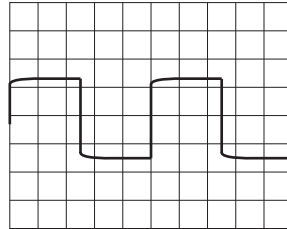

## 2.6 Connecting Logic Probes



### WARNING

- Always turn off the power of the device under measurement before connecting the device under measurement to the instrument.
- Do not apply an input voltage that exceeds the maximum input voltage.
- To avoid electric shock, be sure to ground the instrument, and connect the ground of the probe and input connector to the ground of the item being measured.



### CAUTION

- The maximum input voltage for the 701988 logic probe is  $\pm 42$  V (DC + AC<sub>peak</sub>) or 29 V<sub>rms</sub>, and the maximum input voltage for the 701989 logic probe is  $\pm 40$  V (DC + AC<sub>peak</sub>) or 28 V<sub>rms</sub>. Applying a voltage greater than either of these limits may damage the logic probe or the instrument. If the frequency is high, damage may occur even if the voltage is below the values specified above. For information about derating based on frequency, see the user's manual of the logic probe that you are using.
- The eight input lines on the logic port have a common ground. In addition, the ground for the instrument and the ground for the logic port is also a common ground. Do not apply inputs that have different common voltages, as doing so may cause damage to the instrument, the logic probe, or other connected instruments.
- For information about how to handle a logic probe, refer to the user's manual that came with the logic probe.

### French



### AVERTISSEMENT

- Toujours mettre l'appareil à mesurer hors tension avant de le brancher sur l'instrument.
- Ne pas dépasser les valeurs maximales de tension d'entrée.
- Pour éviter tout risque de choc électrique, relier l'instrument à la terre et brancher la terre de la sonde et du connecteur d'entrée sur la terre de l'appareil à mesurer.



### ATTENTION

- La tension d'entrée maximale pour la sonde logique 701988 est  $\pm 42$  V (c.c. + c.a.crête) ou 29 V<sub>rms</sub>, et la tension d'entrée maximale pour la sonde logique 701989 est  $\pm 40$  V (c.c. + c.a.crête) ou 28 V<sub>rms</sub>. L'application d'une tension supérieure à l'une de ces limites pourrait endommager la sonde logique ou l'instrument. Si la fréquence est élevée, une tension inférieure aux valeurs indiquées ci-dessus pourra tout de même causer des dégâts. Pour toute information sur le déclassement basé sur la fréquence, se reporter au manuel d'utilisation de la sonde logique utilisée.
- Les huit lignes d'entrée du port logique partagent la même terre. De plus, la terre de l'instrument et la terre du port logique sont également partagées. Ne pas appliquer des entrées qui ont des tensions communes différentes car cela pourrait endommager l'instrument, la sonde logique ou tout autre appareil connecté.
- Pour toute information sur la manipulation de la sonde logique, se reporter au manuel d'utilisation fourni avec la sonde logique.

## Logic Signal Input Port

Connect a logic probe (701988 or 701989) to a logic signal input port on the front panel.

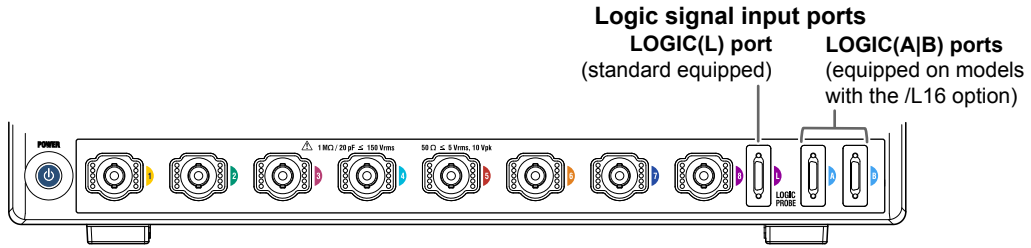

## About Logic Probes

The 701988 and 701989 logic probes are designed to be connected to the instrument's logic signal input port. Use an appropriate connection lead to connect to the point of measurement. Do not alter the connection lead. Doing so may prevent the lead from satisfying the specifications.

The logic port has eight input terminals. You can set the threshold level in the instrument's menu.

Recommended probes: 701988 and 701989

## Logic Input Specifications When Used with the Instrument

The specifications of the 701988 and 701989 are as follows. For details, see page 6-3.

Item	When using the 701988	When using the 701989
Maximum toggle frequency <sup>1</sup>	100 MHz	250 MHz
Number of inputs	8	
Maximum input voltage <sup>2</sup>	$\pm 42\text{ V}$ (DC + ACpeak) or 29 Vrms	$\pm 40\text{ V}$ (DC + ACpeak) or 28 Vrms
Input range	$\pm 40\text{ V}$	$\pm 6\text{ V}$ (around the threshold level)
Maximum sample rate	1.25 GS/s (interleave mode off)	
Threshold level	$\pm 40\text{ V}$ (resolution: 0.05 V)	$\pm 6\text{ V}$ (resolution: 0.05 V)
Threshold accuracy <sup>1</sup>	$\pm(100\text{ mV} + 3\% \text{ of setting})$	
Minimum input voltage <sup>1</sup>	500 mVp-p	300 mVp-p
Input impedance	Approx. 1 M $\Omega$ , approx. 10 pF (typical) <sup>3</sup>	Approx. 100 k $\Omega$ , approx. 3 pF (typical) <sup>3</sup>
Preset threshold levels	CMOS (5 V) = 2.5 V, CMOS (3.3 V) = 1.65 V, CMOS (2.5 V) = 1.25 V, CMOS (1.8 V) = 0.9 V, and ECL = -1.3 V	

1 Under standard operating conditions (see section 6.11) after warm-up

2 For frequencies up to 1 kHz

3 Typical values represent typical or average values. They are not guaranteed.



## 2.7 Attaching the Panel Sheet

Attach the supplied front panel sheet to the instrument as necessary. The front panel sheet that comes with the instrument is determined by the instrument's language code. You can attach the panel sheet over the panel sheet that is affixed to the instrument when it is shipped from the factory.

### Attaching the Panel Sheet

The front panel has six panel sheet hooks: two upper, two lower, one below the ZOOM knob, and one under the LEVEL knob (which is under TRIGGER).

- Hook the panel sheet onto the two upper hooks.
- Then, bend the panel sheet slightly, and hook it to the two lower hooks.
- Hold down the parts of the panel sheet near the ZOOM and LEVEL knobs, and hook the panel sheet to the hooks below the knobs.

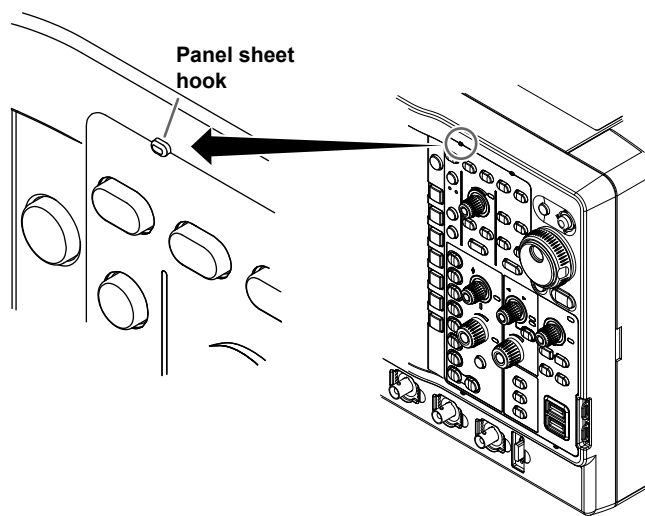

---

## 2.8 Loading Roll Paper into the Built-In Printer (Option)

This section explains how to load roll paper into the optional built-in printer.

### Roll Paper for Printers

Only use roll paper specifically made for use with the DLM4000 series. The DLM4000 comes with one set of roll paper included. Use this when you first load roll paper into the built-in printer. When you require a new supply of roll paper, please contact your nearest YOKOGAWA dealer.

Part Number:	B9988AE
Specifications:	Heat sensitive paper, 10 m
Minimum Quantity:	10 rolls

### Handling Roll Paper

The roll paper is made of heat sensitive paper that changes color thermochemically. Please read the following points carefully.

#### Storage Precautions

The heat-sensitive paper changes color gradually at temperatures of approximately 70°C or higher. The paper can be affected by heat, humidity, or chemicals, whether something has been recorded on it or not. As such, please follow the guidelines listed below.

- Store the paper in a cool, dry, and dark place.
- Use the paper as quickly as possible after you break its protective seal.
- If you attach a plastic film that contains plasticizing material such as vinyl chloride film or cellophane tape to the paper for a long time, the recorded sections will fade due to the effect of the plasticizing material. Use a holder made of polypropylene to store the roll paper.
- When starching the record paper, do not use starches containing organic solvents such as alcohol or ether. Doing so will change the paper's color.
- We recommend that you make copies of the recordings if you intend to store them for a long period of time. Because of the nature of heat-sensitive paper, the recorded sections may fade.

#### Handling Precautions

- Only use genuine, YOKOGAWA-supplied roll paper.
- If you touch the roll paper with sweaty hands, there is a chance that you will leave fingerprints on the paper or smudge the recorded sections.
- If you rub the surface of the roll paper against something hard, there is a chance that the paper will change color due to frictional heat.
- If the roll paper comes into contact with products such as chemicals or oil, there is a chance that the paper will change color or that the recorded sections will disappear.

## Attaching the Roll Paper



### CAUTION

- Do not touch the print head. If you do, you may burn yourself.
- Do not touch the roll paper cutter section at the end of the printer cover. Doing so may cause injury.

### French



### ATTENTION

- Ne pas toucher la tête d'impression. Vous pourriez vous brûler.
- Ne pas toucher la section du coupe-papier à l'extrémité du cache de l'imprimante. Vous pourriez vous blesser.

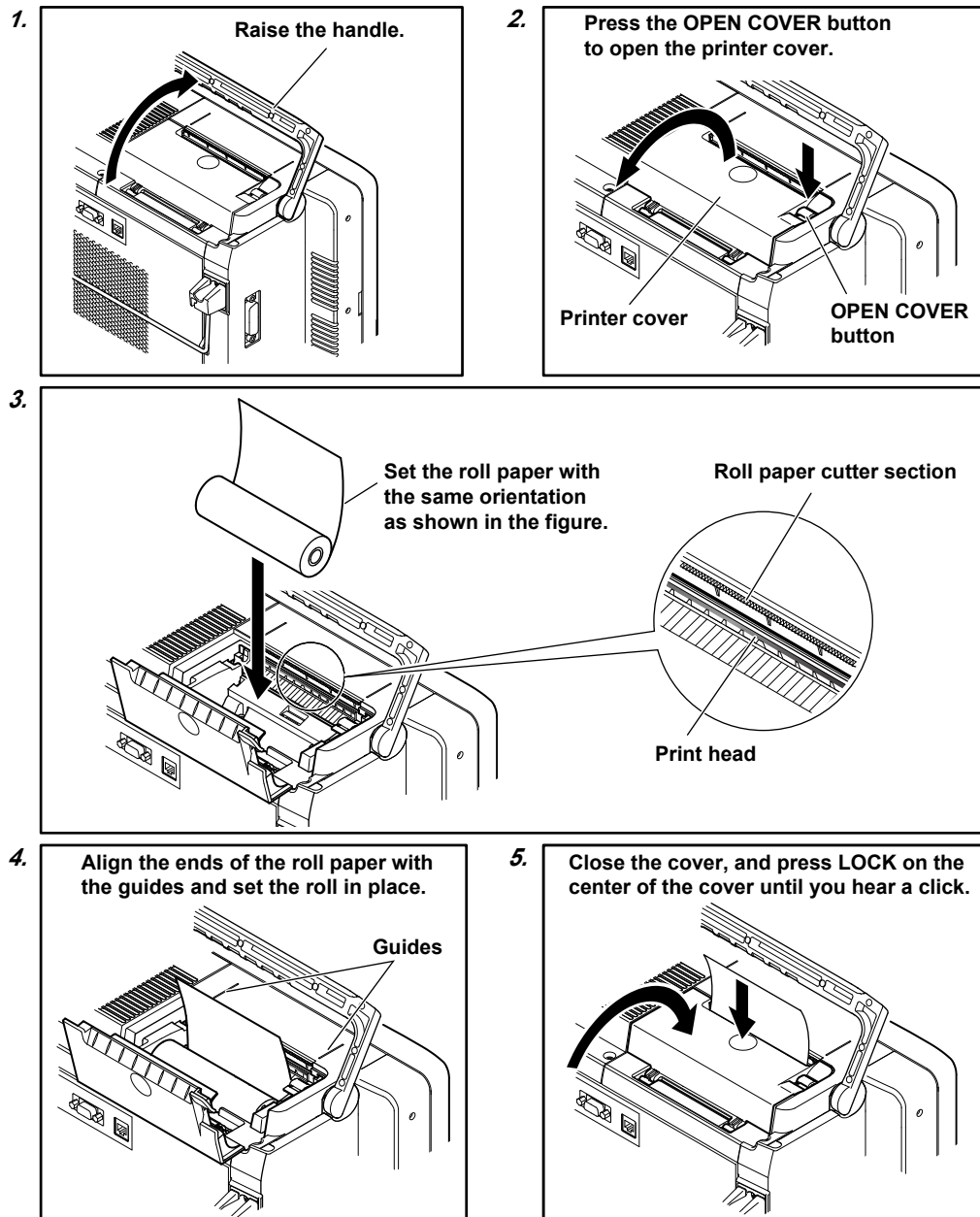

# 3.1 Key and Jog Shuttle Operations

## Key Operations

### How to Use Setup Menus That Appear When Keys Are Pressed

The operation after you press a key varies depending on the key that you press.

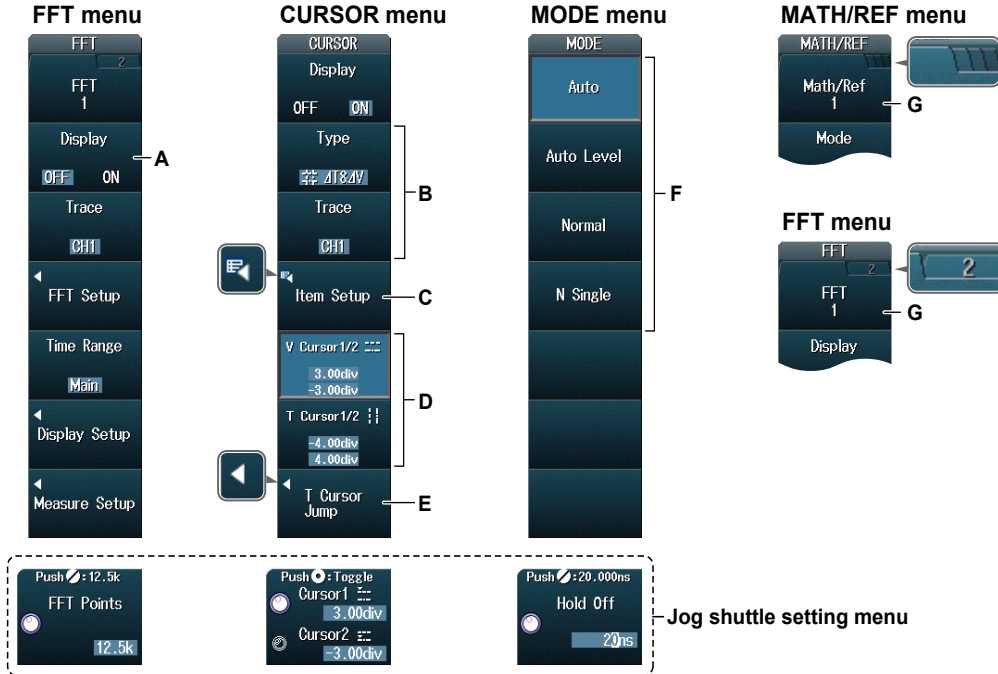

- A: The selection switches each time you press the soft key.
- B: A selection menu appears when you press the soft key.  
Press the soft key that corresponds to the appropriate setting.
- C: A dialog box or the keyboard appears when you press the soft key.  
Use the jog shuttle and the SET key (●) to configure the settings.
- D: Pressing the soft key selects the item that you can control using the jog shuttle. The jog shuttle setup menu, which appears at the bottom end of the setup menu, shows the selected item.
- E: A related setup menu appears when you press the soft key.
- F: Pressing a soft key selects the corresponding option in the soft key.
- G: Selects which item to configure when configuring a feature that consists of multiple items that operate with different settings, such as the Math1 to Math4 and FFT1 and FFT2 computation features.

### How to Display the Setup Menus That Are Written in Purple below the Keys

In the explanations in this manual, “**SHIFT+key name** (written in purple)” is used to indicate the following operation.

1. Press the **SHIFT** key. The SHIFT key illuminates to indicate that the keys are shifted. Now you can select the setup menus written in purple below the keys.
2. Press the key that you want to display the setup menu of.

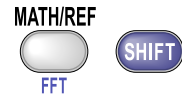

### ESC Key Operation

- If you press ESC when a setup menu or available options are displayed, the screen returns to the menu level above the current one.
- If you press ESC when the highest level menu is shown, the display changes as follows.

Operation of pressing ESC	When measured values are displayed	When measured values are not displayed
1st time	The setup menu disappears.	
2nd time	Measured values move outside the waveform area.	The jog shuttle setting menu disappears.
3rd time	The jog shuttle setting menu disappears.	Nothing changes from this point.
	From this point, the display position of measured values switches between outside the waveform area and inside the area each time you press ESC.	

### 3.1 Key and Jog Shuttle Operations

#### RESET Key (⊘) Operation

If you press RESET when you are using the jog shuttle to set a value or select an item, the setting is reset to its default value (depending on the operating state of the DLM4000, the setting may not be reset).

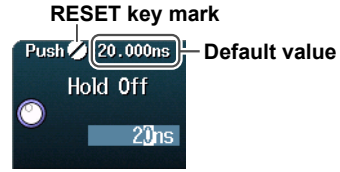

#### SET Key (⊙) Operations

The operation varies as indicated below depending on what you are setting.

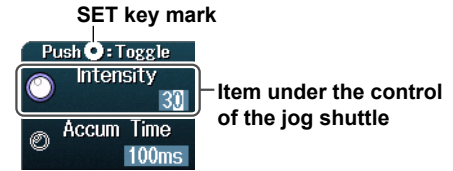

- **When There Are Two Values to Set in the Jog Shuttle Setup Menu**

The setting that the jog shuttle sets switches each time you press the SET key.

- **When the Jog Shuttle and SET Key Marks (⊙+⊙) Are Displayed in the Setup Menu**

Press SET to confirm the selected item.

- **When You Are Setting a Value**

Moving the SET key up or down moves the value up or down.

Moving the SET key to the left and right changes which digit to set.

- **When Selecting the Item to Set**

Moving the SET key up, down, left, and right moves the cursor.

### How to Enter Values in Setup Dialog Boxes

1. Use the keys to display the appropriate setup dialog box.
2. Turn the **jog shuttle**, or move the **SET key** (⊙) up, down, left, or right to move the cursor to the appropriate item.
3. Press the **SET key** (⊙). The operation varies depending on the selected item.

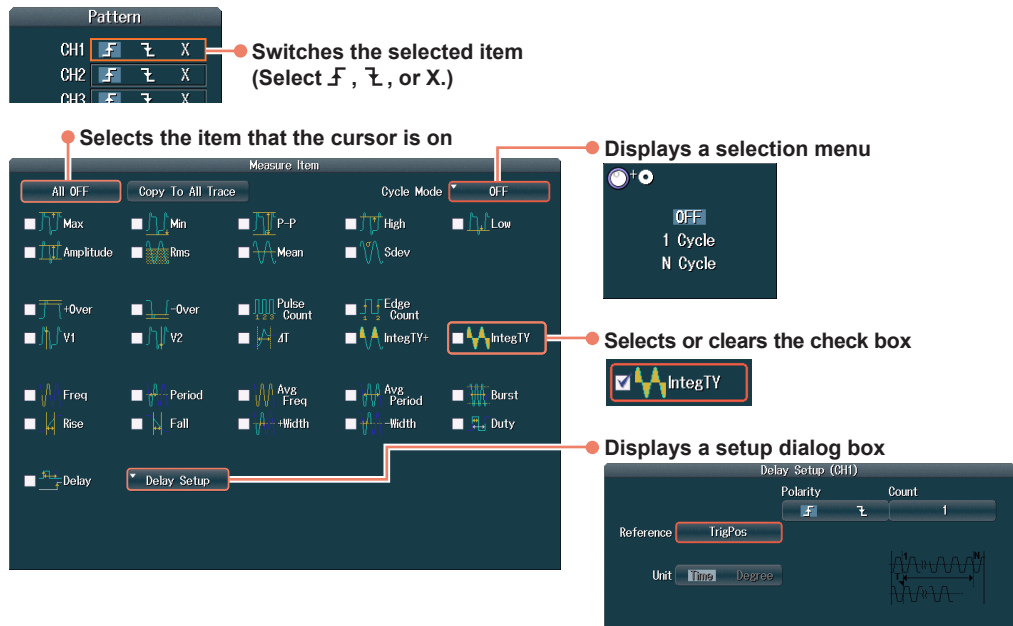

#### How to Clear Setup Dialog Boxes

Press **ESC** to clear the setup dialog box from the screen.

#### Scroll Operation

If a vertical or horizontal scroll bar is shown on the screen, you can move the SET key up and down or left and right to scroll.

---

## 3.2 Entering Values and Strings

### Entering Values

#### Using Dedicated Knobs

You can use the following dedicated knobs to enter values directly.

- ◆ POSITION knobs (VERTICAL)
- ◀ POSITION ▶ knobs (HORIZONTAL)
- SCALE knob (VERTICAL)
- TIME/DIV knob
- LEVEL knob (TRIGGER)
- ZOOM magnification knob

#### Using the Jog Shuttle

Select the appropriate item using the soft keys, and change the value using the jog shuttle and the SET key. This manual sometimes describes this operation simply as “using the jog shuttle.”

#### **Note**

---

Some items that you can set using the jog shuttle are reset to their default values when you press the RESET key.

---

## Entering Character Strings

Use the keyboard that appears on the screen to enter character strings such as file names and comments. Use the jog shuttle and the SET key to operate the keyboard and enter a character string.

**Press to select from character strings you entered previously.**

**Character insertion position**

After selecting a character string by turning the jog shuttle or moving the SET key up and down, confirm your selection by pressing the SET key.

- CAPS** — Switches between uppercase and lowercase
- ←** — Move the character insertion position
- — Move the character insertion position
- Delete** — Deletes the previous character
- BS** — Deletes the previous character
- Clear** — Deletes all the characters you have entered
- Enter** — Confirms the characters that you have entered

## How to Operate the Keyboard

1. After bringing up the keyboard, use the **jog shuttle** to move the cursor to the character that you want to enter. You can also move the **SET** key up, down, left, and right to move the cursor.
2. Press the **SET** key to enter the selected character.
  - If a character string has already been entered, use the **arrow** soft keys to move the cursor to the position you want to insert characters into.
  - Use the **CAPS** soft key to switch between uppercase and lowercase.
  - Use the **Delete** soft key to delete the character at the cursor.
  - Use the **BS** soft key to delete the previous character.
  - Use the **Clear** soft key to clear all the entered characters.
3. Repeat steps 1 and 2 to enter all of the characters in the string.  
 Select on the keyboard to display a list of character strings that you have entered previously. Use the **jog shuttle** to select a character string, and press **SET** to enter the selected character string.
4. Press the **ENTER** soft key, or move the cursor to Enter on the keyboard, and press **SET** to confirm the character string and clear the keyboard.

### Note

- @ cannot be entered consecutively.
- File names are not case-sensitive. Comments are case-sensitive. The following file names cannot be used due to MS-DOS limitations:  
 AUX, CON, PRN, NUL, CLOCK, COM1 to COM9, and LPT1 to LPT9

## 3.3 Using USB Keyboards and Mouse Devices

### Connecting a USB Keyboard

You can connect a USB keyboard and use it to enter file names, comments, and other items.

#### Compatible Keyboards

You can use the following keyboards that conform to USB Human Interface Devices (HID) Class Ver. 1.1.

- When the USB keyboard language is English: 104 keyboards
- When the USB keyboard language is Japanese: 109 keyboards

#### Note

- Do not connect incompatible keyboards.
- The operation of USB keyboards that have USB hubs or mouse connectors is not guaranteed.
- For USB keyboards that have been tested for compatibility, contact your nearest YOKOGAWA dealer.

### USB Ports for Peripherals

Connect a USB keyboard to one of the USB ports for peripherals on the front panel.

#### Connection Procedure

Connect a USB keyboard directly to the DLM4000 using a USB cable. You can connect or remove the USB cable regardless of whether the DLM4000 power switch is on or off (hot-plugging is supported). Connect the type A connector of the USB cable to the DLM4000, and connect the type B connector to the keyboard. When the power switch is turned on, the keyboard is detected and enabled approximately 6 seconds after it is connected.

#### Note

- Only connect compatible USB keyboards, mouse devices, and storage devices to the USB ports for peripherals.
- Do not connect multiple keyboards. You can connect one keyboard and one mouse to the DLM4000.
- If you turn on the DLM4000 when there are USB devices connected to the USB ports for peripherals, the USB devices or the DLM4000 may not operate properly. In such cases, turn off the DLM4000, disconnect the USB devices, turn the DLM4000 back on, and then reconnect the USB devices. After turning off the power, wait at least 10 seconds before you turn it back on.
- Do not connect and disconnect multiple USB devices repetitively. Wait for at least 10 seconds after you connect or remove one USB device before you connect or remove another USB device.
- Do not remove USB cables during the time from when the DLM4000 is turned on until key operation becomes available (approximately 20 seconds).

### Entering File Names, Comments, and Other Items

When a keyboard is displayed on the screen, you can enter file names, comments, and other items using the USB keyboard.



## Using a USB Mouse

You can connect a USB mouse and use it to perform the same operations that you can perform with the DLM4000 keys. Also, by clicking a setup menu or screen item, you can perform the same operation that you can perform by pressing the corresponding item's soft key or selecting the menu item and pressing the SET key.

## USB Ports for Peripherals

Connect a USB mouse to one of the USB ports for peripherals on the front panel of the DLM4000.

## Compatible USB Mouse Devices

You can use mouse devices (with wheels) that are compliant with USB HID Class Version 1.1.

### **Note**

---

- For USB mouse devices that have been tested for compatibility, contact your nearest YOKOGAWA dealer.
  - Some settings cannot be configured by a mouse without a wheel.
- 

## Connection Procedure

To connect a USB mouse to the DLM4000, use one of the USB ports for peripherals. You can connect or disconnect a USB mouse at any time regardless of whether the DLM4000 power switch is on or off (hot-plugging is supported). When the power switch is on, the mouse is detected approximately 6 seconds after it is connected, and the mouse pointer (  ) appears.

### **Note**

---

- Only connect compatible USB keyboards, mouse devices, and storage devices to the USB ports for peripherals.
  - Even though there are two USB ports for peripherals, do not connect two mouse devices to the DLM4000.
  - If you turn on the DLM4000 when there are USB devices connected to the USB ports for peripherals, the USB devices or the DLM4000 may not operate properly. In such cases, turn off the DLM4000, disconnect the USB devices, turn the DLM4000 back on, and then reconnect the USB devices. After turning off the power, wait at least 10 seconds before you turn it back on.
-

## Operating the DLM4000 Using a USB Mouse

### Operations That Correspond to the Front Panel Keys (Top menu)

- **Displaying the Top Menu**

Right-click on the display. A menu of the DLM4000 front panel keys (the top menu) appears.

- **Selecting an Item from the Top Menu**

Click the item that you want to select. A setup menu that corresponds to the item that you selected appears at the bottom of the display. The top menu disappears.

To display an item's submenu, point to the item. To select an item on a submenu, click it, just as you would to select an item on the top menu.

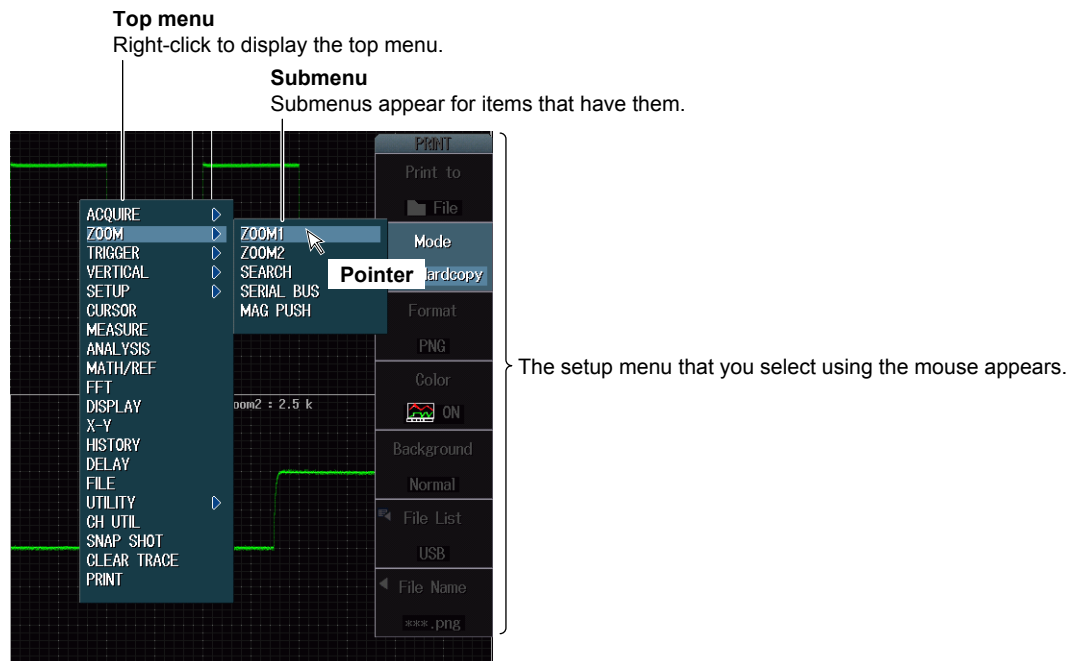

### Note

The following keys are not displayed in the top menu:

ESC, RESET, and SET

**Setup Menu Operations (Same as soft key operations)**

• **Selecting a Setup Menu Item**

Click the setup menu item that you want to select.

If a selection menu appears after you select an item, click the selection menu item that you want to choose.

The operation varies as indicated below depending on the setup menu item.

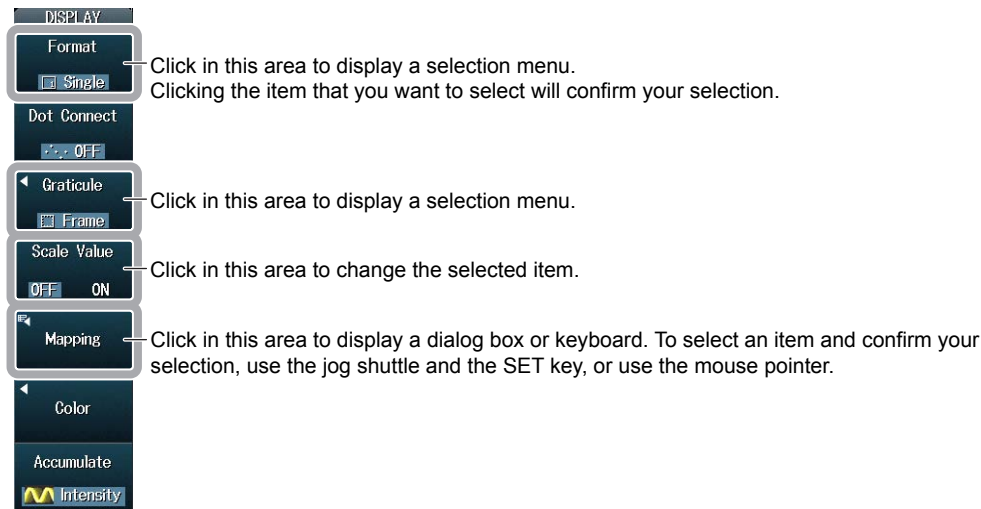

• **Specifying Values**

The following description explains how to specify values for menu items that have a icon next to them.

- If there are two icons next to a single menu item, click on the item to select an item to configure.
- To increase a value, rotate the mouse wheel back.
- To decrease a value, rotate the mouse wheel forward.
- To increase a value, move the pointer above the value so that the pointer becomes a , and then click above the value.
- To decrease a value, move the pointer below the value so that the pointer becomes a , and then click below the value.
- To move the digit cursor between digits, point to the left or right of the value you want to set so that the pointer becomes a or a , and then click the point that you moved the pointer to. The digit cursor will move one digit to the left or right each time you click.

**Change the value by clicking and using the mouse wheel.**



Click in this area to select the item that you want to set with the jog shuttle.

• **Clearing a Setup Menu or Setup Screen**

To clear the menu, click outside of them.

### Selecting Check Boxes

To select an item, click it. A check mark appears next to the item that you selected. To clear an item's check box, click the item again.

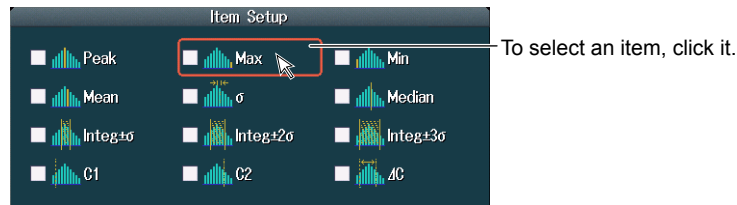

### Note

To close a dialog box, click outside of it.

### Selecting a File, Folder, or Media Drive from a File List

Click on a file, folder (directory), or media drive to select it.

Rotate the mouse wheel to scroll through the file list.

To cancel your selection, click outside of the file list. The file list will close when you cancel your selection.

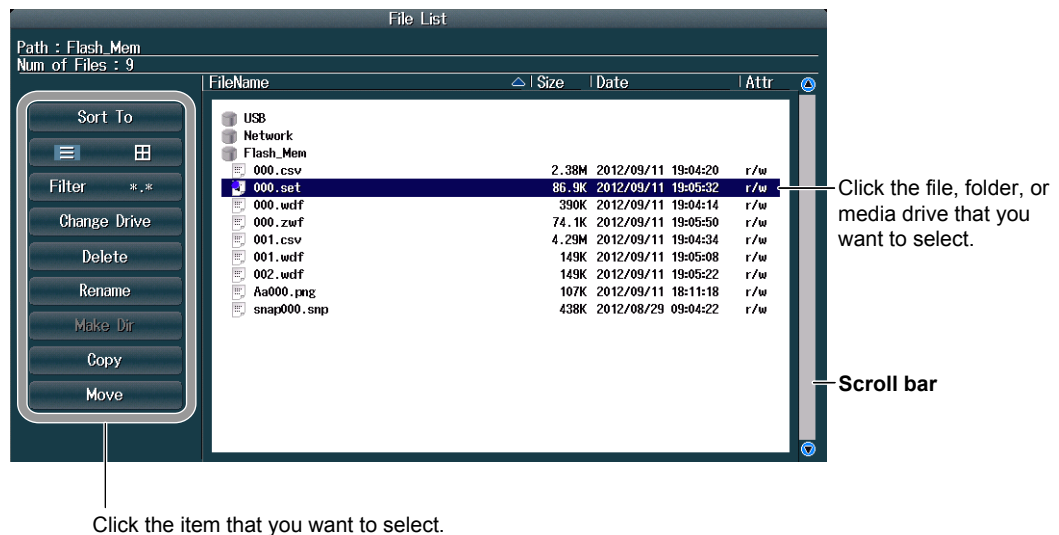

### 3.3 Using USB Keyboards and Mouse Devices

#### Setting the Vertical Scale (V/div) and Time/div

- **Setting the Vertical Scale (V/div)**

When the waveform of a channel whose voltage is being measured appears on the display,

move the pointer close to the V/div value. The pointer becomes a .

Rotate the mouse wheel forward to increase the V/div value, and rotate it back to decrease the value.

- **Setting Time/div**

Move the pointer close to the time/div value that is displayed in the upper right of the screen. The

pointer becomes a .

Rotate the mouse wheel forward to increase the Time/div value, and rotate it back to decrease the value.

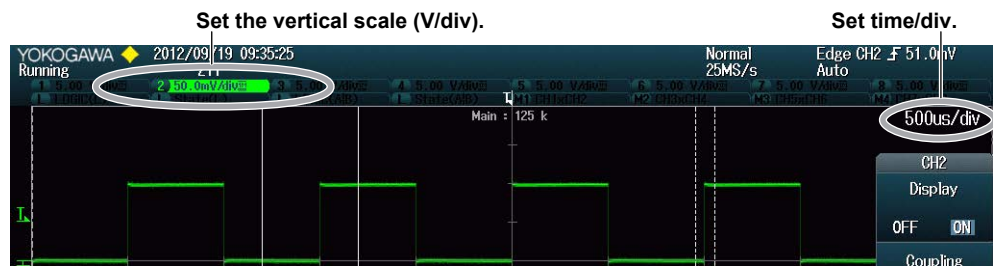

## 3.4 Synchronizing the Clock

This section explains how to set the DLM4000 clock, which is used to generate timestamps for measured data and files. When the DLM4000 is shipped from the factory, it has a set date and time. You must synchronize the clock before you start measurements.

### Procedure

#### UTILITY System Configuration Menu

Press **UTILITY**, the **System Configuration** soft key, and then the **Date/Time** soft key to display the following screen.

### Explanation

#### Turning the Date and Time Display On and Off (Display)

Specify whether to display the date and time on the DLM4000 screen.

#### Setting the Display Format (Format)

Select the display format from one of the following options.

- Year/Month (numeric)/Day
- Day/Month (numeric)/Year
- Day-Month (English abbreviation)-Year (the lower two digits)
- Day Month (English abbreviation) Year

#### Setting the Time Difference from Greenwich Mean Time (Time Diff. GMT)

Set the time difference between the region where you are using the DLM4000 and Greenwich Mean Time.

Selectable range: –12 hours 00 minutes to 13 hours 00 minutes

For example, Japan standard time is ahead of GMT by 9 hours.

In this case, next to Time Diff. GMT, set Hour to 9 and Minute to 00.

#### Checking the Standard Time

Using one of the methods below, check the standard time of the region where you are using the DLM4000.

- Check the Date, Time, Language, and Regional Options on your PC.
- Check the website at the following URL:  
<http://www.worldtimeserver.com/>

#### Note

- The DLM4000 does not support Daylight Saving Time. To set the time to Daylight Saving Time, reset the time difference from Greenwich Mean Time.
- Date and time settings are backed up using an internal lithium battery. They are retained even if the power is turned off.
- The DLM4000 has leap-year information.

---

## 3.5 Performing Auto Setup

### Procedure

#### Executing Auto Setup (AUTO SETUP)

1. Press the **AUTO SETUP** key.  
Auto setup is executed, and an Undo menu item appears.

#### Undoing Auto Setup (Undo)

2. Press the **Undo** soft key.  
The settings from immediately before the auto setup was executed will be restored.

### Explanation

The auto setup feature automatically sets the vertical scale (V/div), time/div, trigger level, and other settings to the most suitable values for the input signals.

#### Center Position after the Execution of Auto Setup

The center position after you execute auto setup will be 0 V.

#### Source Channels

Auto setup is performed on all channels except the logic channel.

If the logic channel is selected (the L key is illuminated), auto setup is not performed on CH8.

Logic waveforms are displayed with the same settings that were used before you executed auto setup.

#### Waveforms Displayed before the Execution of Auto Setup

When you execute auto setup, data in the acquisition memory is overwritten, and the waveforms that were displayed before you executed auto setup are cleared.

#### Undoing Auto Setup

You can press the Undo soft key to restore the settings from immediately before the auto setup was executed. You cannot undo auto setup if you switch to a different setup menu or clear the Undo menu using the ESC key.

#### Signals That Auto Setup Can Be Applied To

Frequency: Approx. 50 Hz or higher

Absolute input voltage: Signals whose maximum value is approximately 20 mV (at 1:1 setting) or more

Type: Simple, repeating signals

#### Note

- The auto setup feature may not work properly for signals that include a DC component or high-frequency components.
  - To measure serial bus signals, execute auto setup from the appropriate serial bus signal setup menu.
-

## Settings after the Execution of Auto Setup

<b>CH1 to CH8 Settings</b>	
Vertical position (Position)	0.00 div
Input coupling (Coupling)	DC
Bandwidth (Bandwidth)	Full
Offset (Offset)	0.00 V
Inverted display (Invert)	OFF
<b>Acquisition Settings</b>	
Record length (Record Length)	The same as the value used before you executed auto setup. However, if the record length is such that the DLM4000 can only acquire waveforms in Single mode, the record length is set to the maximum record length at which the DLM4000 can acquire waveforms repeatedly.
Acquisition mode (Mode)	Normal
High resolution mode (Hi Resolution)	OFF
Interleave (Interleave)	OFF
Sampling mode (Sampling Mode)	Interpolation
<b>Trigger Settings</b>	
Trigger type	EDGE
Trigger mode (Trigger Mode)	Auto
Trigger hold off (Hold Off)	20 ns
Trigger delay (Delay)	0.00000 s
Trigger position (Position)	50%
Trigger slope (Slope)	Rising
Trigger coupling (Coupling)	DC
HF rejection (HF Rejection)	OFF
Noise rejection (Noise Rejection)	<del>A</del>
Window comparator (Window)	OFF
<b>Settings That Depend on the Input Signal</b>	
Display on/off (Display)	On if the DLM4000 detects a voltage of $\pm 20$ mV (1:1) or higher and off otherwise
Vertical scale (V/div)	The DLM4000 selects the range with the highest sensitivity that does not exceed $\pm 3.5$ div.
Trigger level (Trigger Level)	Center
Trigger source (Trigger Source)	The channel with the lowest frequency among the signals whose amplitude (Max – Min) is at least 1 div
Time axis (Time/div)	The fastest sweep range that allows at least two periods of the fastest signal among the signals whose amplitude is at least 1 div to be observed. The sweep range must be at least 5 ms/div.

The values of settings not listed here do not change.



---

## 3.6 Resetting the DLM4000 to Its Factory Default Settings

### Procedure

#### Resetting the DLM4000 to Its Factory Default Settings (DEFAULT SETUP)

1. Press the **DEFAULT SETUP** key.  
The DLM4000 is reset to its factory default settings.  
An Undo menu item appears.

#### Undoing the Reset Operation (Undo)

2. Press the **Undo** soft key.  
The previous settings are restored.

### Explanation

You can reset the DLM4000 settings to their factory default values. This feature is useful when you want to cancel all of the settings that you have entered or when you want to redo measurement from scratch.

#### Settings That Cannot Be Reset to Their Factory Default Values

- Date and time settings
- Communication settings
- Language settings
- Measured value font size setting

#### Undoing the Reset Operation

If you reset the settings by mistake, you can press the Undo soft key to restore the previous settings. However, you cannot undo the reset operation if you clear the Undo menu item by switching to a different setup menu or pressing the ESC key.

#### To Reset All Settings to Their Factory Default Values

While holding down the **RESET** key (⏏), turn the power switch on. All settings are reset to their factory default values except the date and time settings (the display on/off setting will be reset) and the setup data stored in internal memory.

## 3.7 Calibrating the DLM4000

### Procedure

#### UTILITY Calibration Menu

Press **UTILITY** and then press the **Calibration** soft key to display the following menu.

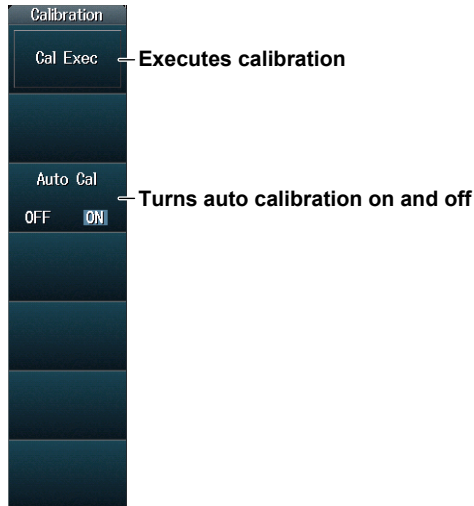

### Explanation

#### Calibration

Calibrates the following items. Execute calibration when you want to make accurate measurements.

- Vertical axis ground level and gain
- Trigger threshold level
- Measured time value for repetitive sampling

#### Note

Calibration is automatically performed for the settings listed above when the power switch is turned on.

#### Notes about Calibration

- Allow the DLM4000 to warm up for at least 30 minutes before you execute calibration. If you execute calibration immediately after power-on, the calibrated values may drift due to temperature changes or other environmental changes.
- Execute calibration in a stable temperature environment ranging from 5 to 40°C (23 ± 5°C recommended).
- Do not apply signals when calibrating. Calibration may not be executed properly when input signals are being applied to the DLM4000.

#### Auto Calibration (Auto Cal)

Auto calibration is executed when you perform one of the following operations and any of the time periods listed below has elapsed since the power was turned on.

3 minutes, 10 minutes, 30 minutes, 1 hour, and each following hour

- When you change time/div during waveform acquisition (when the RUN/STOP key is illuminated)
- When you start waveform acquisition after stopping waveform acquisition (so that the RUN/STOP key is not illuminated)

If calibration is executed while signals are being applied to the DLM4000, we recommend that you stop signal application and recalibrate the DLM4000.

## 3.8 Starting and Stopping Waveform Acquisition

### Procedure

#### Starting and Stopping Waveform Acquisition (RUN/STOP)

1. Press the **RUN/STOP** key.
  - The RUN/STOP key illuminates, and waveform acquisition starts. The acquired waveforms are displayed.
  - If you set the record length to a value that allows only one waveform to be acquired, pressing the RUN/STOP key will produce the same result as pressing the SINGLE key.
2. Press the **RUN/STOP** key again.

The RUN/STOP key light turns off, and waveform acquisition stops.

#### Acquiring a Single Waveform (SINGLE)

1. Press the **SINGLE** key.
  - The SINGLE key illuminates, and waveform acquisition starts. The acquired waveform is displayed.
  - The DLM4000 switches to Single mode and acquires a waveform.
  - When the DLM4000 triggers, it acquires and displays only one waveform and then stops waveform acquisition. The SINGLE key light turns off.
  - To stop waveform acquisition, press the RUN/STOP key.

### Explanation

#### Waveform Acquisition and Indicators

- When the RUN/STOP key or SINGLE key is illuminated, the DLM4000 is acquiring waveforms. “Running” appears in the upper left of the screen.
- When the RUN/STOP key or SINGLE key is not illuminated, waveform acquisition is stopped. “Stopped” appears in the upper left of the screen.

#### DLM4000 Operation When the Acquisition Mode Is Set to Averaging

- Averaging stops when you stop waveform acquisition.
- If you restart waveform acquisition again, averaging starts from the beginning.

#### Running and Stopping Operations during Accumulation

- Accumulation stops when you stop waveform acquisition.
- If you restart waveform acquisition, past waveforms are cleared, and accumulation starts over.

#### Note

- If you start waveform acquisition using RUN/STOP, past data stored in the acquisition memory is cleared.
- You can use the snapshot feature to retain the displayed waveform on the screen. This feature allows you to retain the waveform that you have taken a snapshot of on the screen while the DLM4000 continues signal acquisition.

## 3.9 Displaying Help

### Procedure

#### Displaying Help

Press the **HELP** key (?) to display help.

The table of contents and index appear in the left frame, and text appears in the right frame.

#### Switching between Frames

To switch to the frame that you want to scroll through or otherwise control, move the **SET** key (●) left and right.

#### Moving Cursors and Scrolling

To scroll through the screen or move the cursor in the table of contents or index, turn the **jog shuttle**.

#### Moving to a Link Destination

To move to a description that relates to blue text or to move from the table of contents or index to the corresponding description, move the cursor to the appropriate blue text or item, and press the **SET** key.

#### Displaying Panel Key Descriptions

With help displayed, press a panel key to display an explanation of the panel key.

#### Returning to the Previous Screen

To return to the previous screen, press the **RESET** key (⦿).

#### Hiding Help

Press the **HELP** key (?) or **ESC** key while help is displayed to clear the help.

## 4.1 External Trigger Input (TRIGGER IN)



### CAUTION

Only apply signals that meet the following specifications. Signals that do not meet the specifications may damage the DLM4000, because of factors such as excessive voltage.

#### French



### ATTENTION

N'appliquer que des signaux correspondant aux spécifications suivantes. Les autres signaux pourraient endommager le DLM4000 en raison de divers facteurs, notamment la tension excessive.

### External Trigger Input Terminal

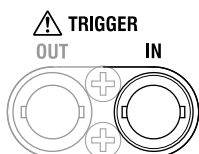

This terminal is used when an external signal is used as the trigger source.

Item	Specifications
Connector type	BNC
Maximum input voltage	$\pm 40$ V (DC + ACpeak) or 28 Vrms when the frequency is 10 kHz or less
Input frequency bandwidth	DC to 100 MHz
Input impedance	Approx. 1 M $\Omega$ , approx. 20 pF
Input range	$\pm 2$ V
Trigger sensitivity	0.1 Vp-p
Trigger level	$\pm 2$ V. The resolution is 5 mV.

## 4.2 Trigger Output (TRIGGER OUT)



### CAUTION

Do not short the TRIGGER OUT terminal or apply external voltage to it. Doing so may damage the DLM4000.

### French



### ATTENTION

Ne pas court-circuiter la borne TRIGGER OUT et ne pas appliquer de tension de sortie. Cela pourrait endommager le DLM4000.

## Trigger Output Terminal

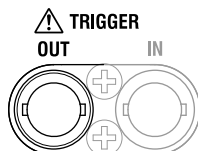

A 3.3 V CMOS level signal is output when the DLM4000 triggers. The signal level is normally high but goes low when the DLM4000 triggers.

Item	Specifications
Connector type	BNC
Output level	3.3 V CMOS
Output impedance	Approx. 50 $\Omega$
Output logic	Negative logic ( $\overline{\square}$ ) and positive logic ( $\square$ ) switchable
Output delay	50 ns or less
Output hold time	For negative logic, the low level is 800 ns min. and the high level is 50 ns min. For positive logic, the high level is 800 ns min. and the low level is 50 ns min.

## Output Timing

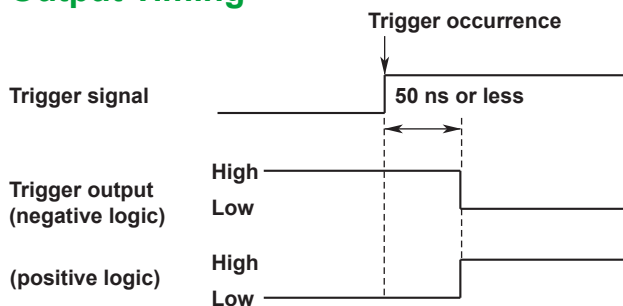

## Low Level and High Level Hold Times

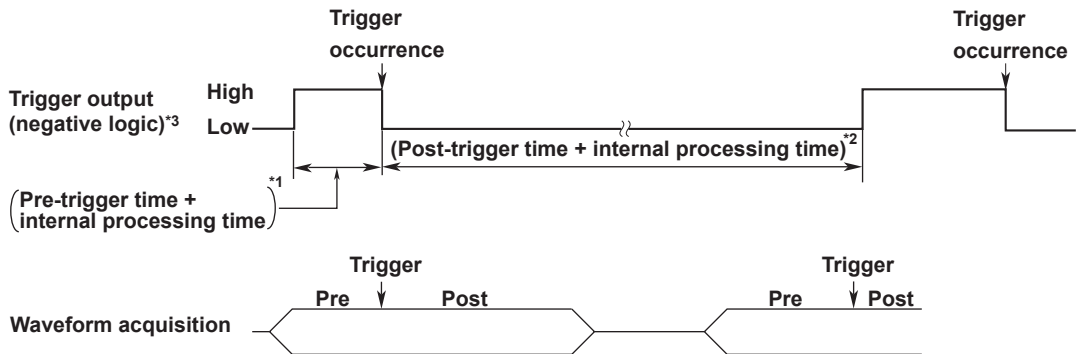

- \*1 High (high level)<sup>3</sup> period: The sum of the pre-trigger time and the internal processing time. The minimum period is 50 ns.
- \*2 Low (low level)<sup>3</sup> period: The sum of the post-trigger time and the internal processing time. The minimum period is 800 ns.
- \*3 When you select positive logic, the definitions of high and low given here are reversed.

## Setting the Output Logic

You can set the output logic for the signal transmitted from the trigger output terminal.

### UTILITY Preference Menu

Press **UTILITY** and then press the **Preference** soft key to display the following menu.

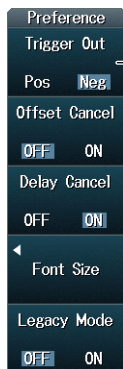

— Set the output logic (Pos: positive logic or Neg: negative logic).

## 4.3 Video Signal Output (VIDEO OUT (XGA))



### CAUTION

- Only connect the DLM4000 to a monitor after turning both the DLM4000 and the monitor off.
- Do not short the VIDEO OUT terminal or apply external voltage to it. Doing so may damage the DLM4000.

### French



### ATTENTION

- Ne brancher le DLM4000 sur un moniteur qu'après avoir mis hors tension le DLM4000 et le moniteur.
- Ne pas court-circuiter la borne VIDEO OUT et ne pas appliquer de tension de sortie. Cela pourrait endommager le DLM4000.

### Video Signal Output Terminal

⚠ VIDEO OUT (XGA)

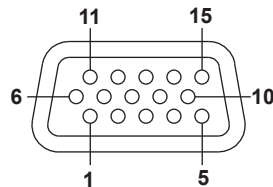
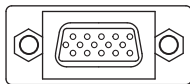

D-Sub 15-pin receptacle

You can use video signal output to display the DLM4000 screen on a monitor. Any multisync monitor that supports XGA can be connected.

Pin No.	Signal Name	Specifications
1	Red	0.7 Vp-p
2	Green	0.7 Vp-p
3	Blue	0.7 Vp-p
4	–	
5	GND	
6	GND	
7	GND	
8	GND	
9	–	
10	GND	
11	–	
12	–	
13	Horizontal sync signal	Approximately 48.4 kHz, TTL negative logic (⎓)
14	Vertical sync signal	Approximately 60 Hz, TTL negative logic (⎓)
15	–	

### Connecting to a Monitor

1. Turn off the DLM4000 and the monitor.
2. Connect the DLM4000 and the monitor using an RGB cable.
3. Turn on the DLM4000 and the monitor.

### Note

- An RGB video signal is always running through the VIDEO OUT terminal.
- The monitor display may flicker if you place the DLM4000 or some other device close to it.
- Depending on the type of monitor, parts of the DLM4000 display may be cut off.



## 4.4 GO/NO-GO Signal Output

### Output Connector

The connector uses an RJ-12 modular jack. Use a cable designed for GO/NO-GO determination, such as optional accessory 366973.

#### Pinout

The pinout is as follows.

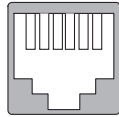

Connector on the DLM4000

Pin No.	Signal Name	Logic
1	NC (no connection)	
2	NC (no connection)	
3	GO OUT	Negative logic
4	NO-GO OUT	Negative logic
5	GND	
6	NC (no connection)	

### Output Signal

#### NO-GO OUT Signal

When the determination result is NO-GO, the output signal level (the TTL level) temporarily changes from high level to low level.

#### GO OUT Signal

When the determination result is GO, the output signal level (the TTL level) temporarily changes from high level to low level.

#### Signal Output Circuit Diagram

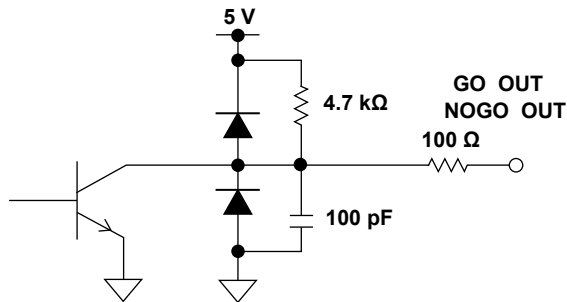

### Output Timing

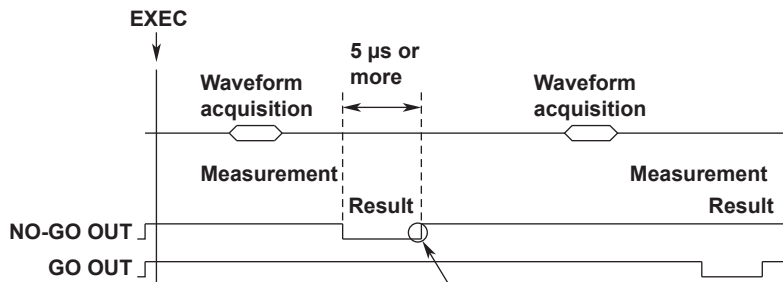

The signal remains low until the DLM4000 is ready to accept the next measurement. If you have specified an action to perform when conditions are true, this time is extended until that action is complete.

## Connecting to Other Instruments



### CAUTION

- Do not apply external voltage to the NO-GO OUT and GO OUT output pins. Doing so may damage the DLM4000.
- When connecting the GO/NO-GO determination signal output to another instrument, do not connect the wrong signal pins. Doing so may damage the DLM4000 or the connected instrument.
- Do not connect a USB cable to the GO/NO-GO output connector. Doing so may damage the DLM4000.

### French



### ATTENTION

- Ne pas appliquer de tension externe aux broches de sortie NO-GO OUT et GO OUT. Cela pourrait endommager le DLM4000.
- Lors de la connexion de la sortie de signal de détermination GO/NO-GO à un autre instrument, veiller à ne pas connecter les mauvaises broches de signal. Cela pourrait endommager le DLM4000 ou l'instrument connecté.
- Ne pas brancher de câble USB sur le connecteur de sortie GO/NO-GO. Cela pourrait endommager le DLM4000.

When connecting to an external instrument, use a cable designed for GO/NO-GO determination, such as optional accessory 366973.

Do not use a cable designed for GO/NO-GO determination (optional accessory 366973) for any purpose other than performing GO/NO-GO determination with the DLM4000.

### Specifications of the GO/NO-GO Cable (Optional accessory 366973)

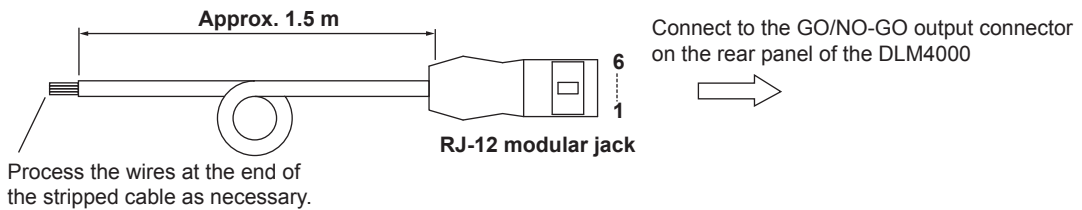

Colors	Pin No.	Signal Name	Logic
Yellow	2	NC	
White	3	GO OUT	Negative logic
Green	4	NO-GO OUT	Negative logic
Blue	5	GND	

## 5.1 If a Problem Occurs

### Faults and Corrective Actions

- If a message appears on the screen, see section 20.1 in the user's manual, IM DLM4038-02EN.
- If servicing is necessary, or if the instrument does not operate properly even after you have attempted to deal with the problem according to the instructions in this section, contact your nearest YOKOGAWA dealer.

Problems and Solutions	Refer To Section
The DLM4000 does not turn on.	
Securely connect the power cord to the DLM4000 and to the power outlet.	2.3
Make sure that the power switch is on.	2.3
Set the supply voltage and frequency to within the permitted range.	2.3
Nothing is displayed.	
Press any key to turn on the backlight.	4.4 <sup>1</sup>
Press the DEFAULT SETUP key to initialize the screen's display colors.	3.6
The display is odd.	
Confirm that the ambient temperature and humidity are within their specified ranges.	2.2
Confirm that the display is not being affected by noise.	2.1
Make sure that the probes are properly connected.	2.4
Restart the DLM4000.	2.3
Keys do not work.	
When the DLM4000 is being controlled remotely through communication commands, press SHIFT + CLEAR TRACE to switch it to local mode.	— <sup>2</sup>
Perform a key test. If the test fails, servicing is required.	20.2 <sup>1</sup>
Triggering does not work.	
Check the trigger conditions.	Chapter 2 <sup>1</sup>
Confirm that the trigger source is being applied.	2.4, 2.6, 4.1
The measured values are not correct.	
Confirm that the ambient temperature and humidity are within their specified ranges.	2.2
Allow the DLM4000 to warm up for at least 30 minutes after turning on the power switch.	2.3
Calibrate the DLM4000.	3.7
Correct the probe phase.	2.5
Set the correct probe attenuation ratio.	1.1 <sup>1</sup>
Set the offset voltage to 0 V.	1.1 <sup>1</sup>
The built-in printer isn't printing.	
The printer head may be damaged or worn out. Servicing is required.	—
It takes time to save to or load from the internal memory.	
The data area may be fragmented, or registered data from deleted files may have remained in the memory. Format the internal memory. When the internal memory is formatted, all of its data is lost. Back up the data as necessary.	20.5 <sup>1</sup>
Unable to save data to the specified storage medium.	
Check the free space on the storage medium. Remove files or use a different storage medium as necessary.	—
The USB devices or the DLM4000 do not operate properly	
If you turn on the DLM4000 when there are USB devices connected to the USB ports for peripherals, turn off the DLM4000, disconnect the USB devices, turn the DLM4000 back on, and then reconnect the USB devices. After turning off the power, wait at least 10 seconds before you turn it back on.	3.3
Unable to configure or control the instrument through the communication interface.	
Check to make sure that the address setting.	— <sup>2</sup>
Match the address used in the program to the DLM4000 address.	
Confirm that the interface meets the electrical and mechanical specifications.	

<sup>1</sup> See the user's manual, IM DLM4038-02EN.

<sup>2</sup> See the Communication Interface User's Manual, IM DLM4038-17EN.

## 5.2 Recommended Part Replacement

The life and replacement period for expendable items varies depending on the conditions of use. Refer to the table below as a general guideline.

For part replacement and purchase, contact your nearest YOKOGAWA dealer.

### Parts with Limited Service Life

Part Name	Service Life
Built-in printer	Under normal conditions of use, equivalent of 360 rolls of printer paper (part number: B9988AE)
LCD backlight	Under normal conditions of use, approximately 25,000 hours

### Consumable Parts

We recommend replacing them at the following intervals.

Part Name	Recommended Replacement Interval
Cooling fan	3 years
Backup battery (lithium battery)	5 years

## 6.1 Signal Input Section

### Analog Signal Input

Item	Specifications		
Number of input channels	8 (CH1 to CH8)		
Input coupling settings	AC1M $\Omega$ , DC1M $\Omega$ , DC50 $\Omega$ , GND		
Input connector	BNC connector		
Input impedance	1 M $\Omega$ $\pm$ 1.0%, approx. 20 pF 50 $\Omega$ $\pm$ 1.0% (VSWR1.4 or less at DC to 500 MHz)		
Selectable voltage sensitivity range (vertical scale)	1 M $\Omega$ input:	2 mV/div to 10 V/div (in 1-2-5 steps)	
	50 $\Omega$ input:	2 mV/div to 500 mV/div (in 1-2-5 steps)	
Maximum input voltage	1 M $\Omega$ input:	150 Vrms (At 100 kHz and higher, the voltage decreases at 20 dB/decade down to 2.5 Vrms.)	
	50 $\Omega$ input:	5 Vrms or less and 10 Vpeak or less; neither values may be exceeded.	
Selectable maximum DC offset range (when the probe attenuation is set to 1:1)	1 M $\Omega$ input		
	2 mV/div to 50 mV/div:	$\pm$ 1 V	
	100 mV/div to 500 mV/div:	$\pm$ 10 V	
	1 V/div to 10 V/div:	$\pm$ 100 V	
	50 $\Omega$ input		
	2 mV/div to 50 mV/div:	$\pm$ 1 V	
	100 mV/div to 500 mV/div:	$\pm$ 5 V	
Vertical-axis (voltage-axis) accuracy			
DC accuracy <sup>1</sup>	$\pm$ (1.5% of 8 div + offset voltage accuracy)		
Offset voltage accuracy <sup>1</sup>	2 mV/div to 50 mV/div:	$\pm$ (1% of set value + 0.2 mV)	
	100 mV/div to 500 mV/div:	$\pm$ (1% of set value + 2 mV)	
	1 V/div to 10 V/div:	$\pm$ (1% of set value + 20 mV)	
Frequency bandwidth ( $\geq$ -3 dB) <sup>1,2</sup> ( $\pm$ 3 div-p sine wave input)	1 M $\Omega$ input (measured from the probe tip when using the supplied 10:1 probe (10:1 conversion))	DLM4038	DLM4058
	100 V/div to 100 mV/div:	DC to 350 MHz	DC to 500 MHz
	50 mV/div to 20 mV/div:	DC to 300 MHz	DC to 400 MHz
	50 $\Omega$ input		
	500 mV/div to 10 mV/div:	DC to 350 MHz	DC to 500 MHz
	5 mV/div to 2 mV/div:	DC to 300 MHz	DC to 400 MHz
-3 dB point for AC coupling	10 Hz or less (1 Hz or less when using the supplied 10:1 probe)		
Skew between channels (when channels are set to the same conditions)	1 ns or less		
Residual noise level <sup>3</sup>	0.4 mVrms or 0.05 div rms, whichever is greater (typical value <sup>4</sup> )		
Isolation between channels (when set to the same voltage sensitivity)	Maximum bandwidth: -34 dB (typical value <sup>4</sup> )		
A/D converter resolution	8 bits (25 LSB/div) 12 bits maximum (during high-resolution mode)		
Probe attenuation settings	Voltage probe:	0.001:1 to 2000:1 (in 1-2-5 steps)	
	Current probe:	0.001A:1V to 2000A:1V (in 1-2-5 steps)	
Bandwidth limit	For each channel, can be set to FULL, 200 MHz, 100 MHz, 20 MHz, 10 MHz, 5 MHz, 2 MHz, 1 MHz, 500 kHz, 250 kHz, 125 kHz, 62.5 kHz, 32 kHz, 16 kHz, or 8 kHz. Uses IIR and FIR digital filters		
Maximum sample rate	Real-time sampling mode. Values inside parentheses are for high resolution mode. <sup>2</sup>		
	When interleave mode is on:	2.5 GS/s (1.25 GS/s)	
	When interleave mode is off:	1.25 GS/s (625 MS/s)	
	Repetitive sampling mode:	125 GS/s	
	Interpolation sampling mode:	125 GS/s	

## 6.1 Signal Input Section

Item	Specifications
Maximum record length	Maximum record length for which repetitive acquisitions are possible
	No options: 1.25 M points
	On models with the /M1 option: 6.25 M points
	On models with the /M2 option: 12.5 M points
	On models with the /M3 option: 25 M points
	Maximum record length for which a single acquisition is possible. Values inside parentheses apply when interleave mode is on.
	No options: 6.25 M points (12.5 M points)
	On models with the /M1 option: 25 M points (62.5 M points)
On models with the /M2 option: 62.5 M points (125 M points)	
On models with the /M3 option: 125 M points (250 M points)	

- 1 Values measured under standard operating conditions (see section 6.11 for details) after a 30-minute warm-up and calibration.
- 2 Values for repeating phenomena.  
The single-shot frequency bandwidth is from DC to the sampling frequency/2.5 or is the frequency bandwidth of the repeating phenomena, whichever is less.
- 3 Values when the input section is shorted, the acquisition mode is set to Normal, accumulation is set to off, and the probe attenuation is set to 1:1.
- 4 Typical values represent typical or average values. They are not strictly warranted.

## Logic Signal Input

Item	Specifications	
Usable probes	701988, 701989 (8-bit input)	
Number of inputs	Standard LOGIC(L) port: 8 LOGIC(A B) ports on models with the /L16 option: 16 additional bits	
Nondestructive maximum input voltage	701988: $\pm 42$ V (DC + AC <sub>peak</sub> ) or 29 V <sub>rms</sub> 701989: $\pm 40$ V (DC + AC <sub>peak</sub> ) or 28 V <sub>rms</sub> For information about derating based on frequency, see the respective logic probe user's manual.	
Input range	When using the 701988 $\pm 40$ V	When using the 701989 Threshold level $\pm 6$ V
Minimum input voltage	500 mVp-p	300 mVp-p
Maximum toggle frequency <sup>1</sup>	100 MHz	250 MHz
Input impedance (typical value <sup>2</sup> )	1 M $\Omega$ /approx. 10 pF	Approx. 100 k $\Omega$ /approx. 3 pF
Threshold level setting	Same value for all 8 bits	Different values for each of the 8 bits
Variable threshold level range	$\pm 40$ V	$\pm 6$ V
Threshold level resolution	0.05 V	0.05 V
Threshold level accuracy <sup>1</sup>	$\pm(0.1$ V + 3% of setting)	$\pm(0.1$ V + 3% of setting)
Hysteresis voltage (typical value <sup>2</sup> )	100 mV	When noise rejection is off: 100 mV When noise rejection is on: 250 mV
Minimum pulse width	5 ns	2 ns
Maximum sample rate	Real-time sampling mode. Values inside parentheses are for high resolution mode. <sup>3</sup> When interleave mode is on: LOGIC(L) port Unable to acquire logic waveforms LOGIC(A B) ports 1.25 GS/s (1.25 GS/s) <sup>4</sup> When interleave mode is off: 1.25 GS/s (625 MS/s) Repetitive sampling mode: 125 GS/s Interpolation sampling mode: 125 GS/s	
Maximum record length	Maximum record length for which repetitive acquisitions are possible No options: 1.25 M points On models with the /M1 option: 6.25 M points On models with the /M2 option: 12.5 M points On models with the /M3 option: 25 M points Maximum record length for which a single acquisition is possible. Record lengths in parentheses are available for the LOGIC(A B) ports when interleave mode is on. No options: 6.25 M points (12.5 M points) On models with the /M1 option: 25 M points (62.5 M points) On models with the /M2 option: 62.5 M points (125 M points) On models with the /M3 option: 125 M points (250 M points)	

<sup>1</sup> Under standard operating conditions (see section 6.11 for details) after a 30-minute warm-up.

<sup>2</sup> Typical values represent typical or average values. They are not strictly warranted.

<sup>3</sup> Resolution only improves for analog waveforms.

<sup>4</sup> If high resolution mode is off and the sample rate of analog channels is 2.5 GS/s, interpolation (sampling) mode is used.

## 6.2 Triggering Section

Item	Specifications
Triggered modes	Auto, Auto Level, Normal, Single, N Single, Single The DLM4000 measures in Single mode when you start acquisition by pressing the SINGLE key or when you start acquisition by pressing the RUN/STOP key when the record length setting only allows for single acquisition.
Trigger sources	CH1 to CH8: Signals received through input terminals LINE: The connected commercial power supply signal (only Edge trigger can be used) EXT: The signal received through the TRIG IN terminal LOGIC: Signals received through the logic signal input port terminals Source bits: L0 to L7, A0 to A7 <sup>1</sup> , B0 to B7 <sup>1</sup>
Trigger coupling	CH1 to CH8: DC/AC EXT: DC
HF rejection	Trigger source bandwidth limit can be specified separately for CH1 to CH8. OFF: No bandwidth limit 15 kHz: DC to approximately 15 kHz 20 MHz: DC to approximately 20 MHz
Noise rejection	Noise rejection can be turned on or off (trigger level hysteresis can be selected) for CH1 to CH8 separately. Noise rejection cannot be specified on channels set to TV trigger. OFF: Approximately 0.3 div of hysteresis ON: Approximately 1.0 div of hysteresis
Selectable trigger level range	CH1 to CH8: $\pm 4$ div from the screen center EXT: $\pm 2$ V
Trigger level resolution	CH1 to CH8: 0.01 div (0.1 div for TV triggers) EXT: 5 mV
Trigger level accuracy	CH1 to CH8: <sup>2</sup> $\pm(0.2 \text{ div} + 10\% \text{ of the trigger level})$ EXT: <sup>3</sup> $\pm(50 \text{ mV} + 10\% \text{ of the trigger level})$
Window comparator setting	Window comparator can be turned on or off for CH1 to CH8 separately. OFF: Normal comparator Edge polarities: Rise and Fall. Qualifications: H, L, and X. ON: Window comparator Edge polarities: Enter and Exit. Qualifications: IN, OUT, and X.
Selectable window trigger level range	Can be set separately for CH1 to CH8. Center: $\pm 4$ div from the screen center Width: $\pm 4$ div around the center
Window trigger level accuracy	The following trigger level accuracy applies to the upper and lower limits of the window that are specified using the Center and Width settings. The upper and lower limits are set separately for CH1 to CH8. $\pm(0.2 \text{ div} + 10\% \text{ of the trigger level})$ However, the accuracy does not apply to an upper or lower limit that falls outside $\pm 4$ div from the screen center.
External trigger probe attenuation setting	1:1, 10:1
Trigger sensitivity	CH1 to CH8: 1 div <sub>P-P</sub> DC to the maximum bandwidth (with noise rejection set to off) EXT: 100 mV <sub>P-P</sub> DC to 100 MHz
Trigger position	Can be set as a percentage of the display record length in 0.1% steps
Selectable trigger delay range	–(Time length of the post-trigger section) to +10 s
Selectable hold-off time range	20 ns to 10 s

<sup>1</sup> A0 to A7 and B0 to B7 are available on models with the /L16 option.

<sup>2</sup> Values measured under standard operating conditions (see section 6.11 for details) after a 30-minute warm-up and calibration.

<sup>3</sup> Values measured under standard operating conditions (see section 6.11 for details) after a 30-minute warm-up.



Item	Specifications
Trigger type (A trigger)	<p>Edge: Triggers on the edge of a single trigger source The source can be set to a signal from CH1 to CH8, LOGIC<sup>1</sup>, EXT, or LINE.</p> <p>Edge OR: Triggers when any of the edge trigger conditions of multiple trigger sources is met Sources can be set to channels from CH1 to CH8.</p> <p>Edge Qualified: Triggers on the edge of a single trigger source while qualifications are met The source can be set to a signal from CH1 to CH8, LOGIC<sup>1</sup>, or EXT. Qualifications can be specified for CH1 to CH8 and LOGIC<sup>1</sup>.</p> <p>State: Triggers when a pattern (conditions of signals) changes from met to not met or from not met to met A clock channel can be specified for determining whether the pattern has been met or not met. No clock can also be selected. Patterns can be combined using AND or OR. The pattern signals and clock source can be set to a signal from CH1 to CH8 or LOGIC<sup>1</sup>.</p> <p>Pulse Width: Triggers on the width of a single trigger source The source can be set to a signal from CH1 to CH8 or LOGIC<sup>1</sup>.</p> <p>More than: Triggers when the time length during which the condition is met is longer than Time1, and the condition changes to not met Time1: 4 ns to 10 s in 2-ns steps</p> <p>Less than: Triggers when the time length during which the condition is met is shorter than Time1, and the condition changes to not met Time1: 6 ns to 10 s in 2-ns steps</p> <p>Between: Triggers when the time length during which the condition is met is longer than Time1 but shorter than Time2 and the condition changes to not met Time1: 4 ns to (10 s – 4 ns) in 2-ns steps Time2: 8 ns to 10 s in 2-ns steps Minimum spacing between Time1 and Time2: 4 ns</p> <p>OutOfRange: Triggers when the time length during which the condition is met is shorter than Time1 or longer than Time2 and the condition changes to not met Time1: 6 ns to (10 s – 4 ns) in 2-ns steps Time2: 8 ns to 10 s in 2-ns steps Minimum spacing between Time1 and Time2: 4 ns (2 ns only when Time1 = 6 ns and Time2 = 8 ns)</p> <p>TimeOut: Triggers when the time length during which the condition is met exceeds Time1 Time1: 4 ns to 10 s in 2-ns steps</p> <p>Time accuracy:<sup>2</sup> ±(0.5% of setting + 2 ns)</p> <p>Minimum time detection width: 2 ns (typical value<sup>3</sup>)</p> <p>State Width: Triggers on the time-duration for which a pattern (conditions of signals) is met or not met For details on the pattern signals and clock source and pattern combination, see “State.” For details on the time settings, see “Pulse Width.”</p> <p>FlexRay:<sup>4</sup> Triggers on a FlexRay bus signal The source can be set to a signal from CH1 to CH8. Mode: Frame Start, Error, ID/Data, ID OR Bit Rate: 2.5 M, 5 M, 10 Mbps Bus channel: A, B</p> <p>CAN:<sup>4</sup> Triggers on a CAN (Controller Area Network) bus signal The source can be set to a signal from CH1 to CH8. Mode: SOF, Error, ID/Data, ID OR Bit Rate: 33.3 k, 83.3 k, 125 k, 250 k, 500 k, 1 Mbps, User Define For User Define, you can set a value from 10 k to 1 Mbps in 0.1-kbps steps.</p>

1 For LOGIC ports, L0 to L7, A0 to A7 and B0 to B7 bits can be set individually or at the port level.

A0 to A7 and B0 to B7 are available on models with the /L16 option.

2 Values measured under standard operating conditions (see section 6.11 for details) after a 30-minute warm-up.

3 Typical values represent typical or average values. They are not strictly warranted.

4 FlexRay and CAN are options.

## 6.2 Triggering Section

Item	Specifications
CAN FD: <sup>1</sup>	<p>Triggers on a CAN FD bus signal (ISO 11898-1: 2015 or non-ISO)            The source can be set to a signal from CH1 to CH8.            Mode: SOF, Error, ID/Data, ID OR, FDF, ESI            Bit Rate: Arbitration phase                      250 k, 500 k, 1 Mbps, User Define                      For User Define, you can set a value from 20 k to 1 Mbps in 0.1-kbps steps.            Data phase                      500 k, 1 Mbps, 2 Mbps, 4 Mbps, 5 Mbps, 8 Mbps, User Define                      For User Define, you can set a value from 250 k to 10 Mbps in 0.1-kbps steps.</p>
LIN: <sup>1</sup>	<p>Triggers on a LIN (Local Interconnect Network) bus signal            The source can be set to a signal from CH1 to CH8.            Mode: Break Synch, Error, ID/Data, ID OR            Bit Rate: 1200, 2400, 4800, 9600, 19200bps, User Define            For User Define, you can set a value from 1 k to 20 kbps in 0.01-kbps steps.</p>
SENT: <sup>1</sup>	<p>Triggers on SENT signals (J2716 APR2016 and earlier)            The source can be set to a signal from CH1 to CH8 or LOGIC<sup>2</sup>.            Mode: Every Fast CH, Fast CH S&amp;C (Status &amp; Communication), Fast CH Data, Every Slow CH, Slow CH ID/Data, Error            Clock period: 1 µs to 100 µs (resolution: 0.01 µs)</p>
PSI5 Airbag: <sup>1</sup>	<p>Triggers on PSI5 Airbag signal            The source can be set to a signal from CH1 to CH8.            Mode: Sync, Start Bit, Data            Bit Rate: 125kbps, 189kbps, User Define            For User Define, you can set a value from 10.0 k to 1000.0 kbps in 0.1-kbps steps.</p>
UART: <sup>1</sup>	<p>Triggers on a UART (RS232) signal            The source can be set to a signal from CH1 to CH8 or LOGIC<sup>2</sup>.            Mode: Every Data, Error, Data            Format: 8-bit data (no parity bit), 7-bit data + parity bit, 8-bit data + parity bit            Bit Rate: 1200, 2400, 4800, 9600, 19200 bps, 38400 bps, 57600 bps, 115200 bps, User Define            For User Define, you can set a value from 1 k to 10000 kbps in 0.1 kbps steps.</p>
I2C: <sup>1</sup>	<p>Triggers on an I2C bus signal            The source can be set to a signal from CH1 to CH8 or LOGIC<sup>2</sup>.            Mode: Every Start, Adr Data, NON ACK, General Call, Start byte, HS Mode</p>
SPI: <sup>1</sup>	<p>Triggers on an SPI (Serial Peripheral Interface) bus signal            The source can be set to a signal from CH1 to CH8 or LOGIC<sup>2</sup>.            Mode: 3 Wire, 4 Wire</p>
User Define:	<p>Triggers on a general-purpose serial communication signal            The source can be set to a signal from CH1 to CH8.            Data channel, chip select channel, clock channel, and latch channel can be specified.            Bit Rate: 1 k to 100 Mbps (with clock)                      1 k to 50 Mbps (without clock)            Data Size: 1 to 128 bits</p>

<sup>1</sup> CAN FD, LIN, SENT, PSI5, UART, I2C, and SPI are options.

<sup>2</sup> For LOGIC ports, L0 to L7, A0 to A7 and B0 to B7 bits can be set individually or at the port level.  
 A0 to A7 and B0 to B7 are available on models with the /L16 option.

Item	Specifications
	<p>TV: Triggers on the specified field number, line number, or polarity in video signals of various broadcasting systems. The source can be set to a signal from CH1 to CH8.</p> <p>Mode: NTSC: Triggers on an NTSC (525/60/2) signal PAL: Triggers on a PAL (625/50/2) signal SDTV: Triggers on an SDTV (480/60p) signal HDTV: Triggers on the following HDTV signals 1080/60i, 1080/50i, 720/60p, 1080/25p, 1080/24p, 1080/24sF, 1080/60p UserdefTV: You can trigger on any TV signal by selecting standard or high definition, setting the H sync period, and setting the sync guard. Sync guard can be set to a value from 60 to 90% of the H sync value in 1% steps.</p> <p>Polarity: Pos, Neg HF Rej: NTSC/PAL: 300 kHz (fixed) SDTV/HDTV: OFF (fixed) UserdefTV: Off or 300 kHz</p> <p>Line: 5 to 1054(NTSC), 2 to 1251(PAL), 8 to 2251(SDTV), 2 to 2251(HDTV), 2 to 2251(UserdefTV), ALL</p> <p>Field: 1, 2, X Frame Skip: 1, 2, 4, 8</p>
AB trigger	<p>A trigger set with the B TRIG key Triggers on the combination of triggers A and B The trigger conditions specified with the EDGE or ENHANCED key are assigned to trigger A; trigger conditions specified with the B TRIG menu are assigned to trigger B.</p> <p>Some trigger types cannot be specified depending on the AB trigger type as shown below.</p> <p>OFF: Triggers only on the trigger A conditions (the trigger B conditions are not used).</p> <p>A Delay B: After the trigger A conditions are met and the specified amount of time elapses, the DLM4000 triggers when the trigger B conditions are met. Trigger B cannot be set to Edge OR, Width, PSI5 Airbag, or TV. Delay value: 10 ns to 10 s</p> <p>A → B(N): After the trigger A conditions are met, the DLM4000 triggers when the trigger B conditions are met N times. Trigger B cannot be set to Edge OR, Width, PSI5 Airbag, or TV. N value: 1 to 10<sup>9</sup></p> <p>Dual Bus: Triggers when the serial bus trigger (except PSI5 Airbag) A or B conditions are met.</p>
Forced trigger	A trigger that is forced, regardless of whether the trigger conditions are met.

## 6.3 Time Axis

Item	Specifications
Selectable time scale range	1 ns/div to 500 s/div
Timebase accuracy*	±0.002%
Time measurement accuracy*	±(0.002% + 50 ps + 1 sample period)

\* Values measured under standard operating conditions (see section 6.11 for details) after a 30-minute warm-up.

## 6.4 Display

Item	Specifications
Display	12.1-inch (31.4 cm) color TFT LCD*
Display screen size	245.76 mm (width) × 184.32 mm (height)
Resolution of the entire screen	1024 × 768 (XGA)
Resolution of the waveform display	1000 × 640

\* The LCD may include a few defective pixels (within 4 ppm over the total number of pixels including RGB). The LCD may contain some pixels that are always illuminated or that never illuminate. Please be aware that these are not defects.

## 6.5 Features

### Vertical and Horizontal Control

Item	Specifications
Channel on/off	CH1 to CH8 and LOGIC can be turned on and off separately. Either CH8 or LOGIC (L) can be turned on at any given time. When interleave mode is on, all even-numbered channels, including LOGIC (L), are automatically are turned off.
Logic signal bus display	The bits of the LOGIC(L) port can be assigned to Bus, and the bits of the LOGIC(A B) ports can be assigned to Bus2 or Bus3. The assigned bits can be shown on a bus display. The bus display shows the logic signal in accordance with the specified format (Format) and bit order (Bit Order).
Logic signal state display	Displays logic signals that have been sampled on the edges of a clock signal. Even when the input signal changes, a state is retained until the clock source edge changes. For the LOGIC(L) port, you can select the clock source from CH5 to CH7 or from L0 to L7. For the LOGIC(A B) ports, you can select from A0 to A7 and B0 to B7.
Vertical position	Turning the vertical position knob moves the vertical position of a waveform in the range of $\pm 4$ div. Analog waveforms (analog signal waveforms): A waveform can be moved in the range of $\pm 4$ div from the center of the waveform display frame. CH1 to CH8 are moved separately. Logic waveforms (logic signal waveforms): The center of logic waveforms can be moved in the range of $\pm 4$ div from the center of the waveform display frame. Press the vertical position knob to reset the position to its default value (0 div).
Vertical scale	The vertical SCALE knob can be used to set the voltage per grid division (V/div) or the current per grid division (A/div). Press the SCALE knob to switch between a mode in which you can set values in 1-2-5 steps or a mode in which you can set values in detail (FINE). For the selectable range when using 1-2-5 steps, see "Analog Signal Input" in Section 6.1, "Signal Input Section." FINE vertical sensitivity is achieved through digital zooming. If you change the scale while the DLM4000 is stopped, you can vertically expand or reduce waveforms. Logic waveforms can be expanded to three different display-size levels.
Input filtering	Bandwidth limit can be specified for CH1 to CH8 separately. For the available filter types, see "Bandwidth limit" in section 5.1, "Signal Input Section."
Offset cancelling	Can be set to on or off for CH1 through CH8 OFF: Does not apply the specified offset to the result of cursor measurements, computations, and automated measurement of waveform parameters. ON: Applies the specified offset to the result of cursor measurements, computations, and automated measurement of waveform parameters.
Inverted display	Waveforms can be inverted around the vertical position for CH1 to CH8 separately. Configuration and measurement are executed on the waveforms before the inversion.
Linear scaling	Scaling coefficient, offset value, and unit can be specified for CH1 to CH8 separately.
Logic signal threshold level preset	You can choose from the following preset threshold level settings. CMOS (5V) = 2.5 V, CMOS (3.3V) = 1.65 V, CMOS (2.5V) = 1.25 V, CMOS (1.8V) = 0.90 V, ECL = -1.30 V
Deskewing	The time offset (skew) between CH1 to CH8 and logic signals can be adjusted. CH1 to CH8 can be adjusted separately. Logic waveforms can be adjusted at the port (pod (8-bit)) level. Adjustment at the bit level is not possible. Trigger deskewing is also not possible. The adjustable range is $\pm 100$ ns in 0.01 ns steps.
Horizontal position	You can set the waveform's horizontal display position by using the horizontal position knob to set the trigger position or trigger delay. What the knob controls is indicated by the DELAY key LED. LED off: Trigger position LED on: Trigger delay For trigger position and trigger delay specification details, see "Trigger position" or "Selectable trigger delay range" in section 6.2, "Triggering Section."
Delay cancelling	You can select whether to apply the specified delay to the time measurement values. ON: Measures time with the trigger position set to 0 s (does not apply the delay to time measurement). OFF: Measures time with the trigger point set to 0 s (applies the delay to time measurement).

\* The LOGIC(A|B) ports are available on models with the /L16 option.

## 6.5 Features

Item	Specifications																
Horizontal (time) scale	The TIME/DIV knob can be used to set the time per grid division. For the selectable range, see “Selectable time scale range” in section 6.3, “Time Axis.” If you change the time scale while the DLM4000 is stopped, you can expand or reduce waveforms along the time axis.																
Roll mode	The DLM4000 switches to roll mode display when the trigger mode is set to Auto, Auto Level, or Single for the following time scale ranges. For details on the trigger modes, see “Trigger modes” in section 6.2, “Triggering Section.”																
	<table border="1"> <thead> <tr> <th>Specified Record Length</th> <th>Time Scale</th> </tr> </thead> <tbody> <tr> <td>1.25 M points or less</td> <td>100 ms/div to 500 s/div</td> </tr> <tr> <td>6.25 M points</td> <td>500 ms/div to 500 s/div</td> </tr> <tr> <td>12.5 M points</td> <td>500 ms/div to 500 s/div</td> </tr> <tr> <td>25 M points</td> <td>1 s/div to 500 s/div</td> </tr> <tr> <td>62.5 M points</td> <td>5 s/div to 500 s/div</td> </tr> <tr> <td>125 M points</td> <td>5 s/div to 500 s/div</td> </tr> <tr> <td>250 M points</td> <td>10 s/div to 500 s/div</td> </tr> </tbody> </table>	Specified Record Length	Time Scale	1.25 M points or less	100 ms/div to 500 s/div	6.25 M points	500 ms/div to 500 s/div	12.5 M points	500 ms/div to 500 s/div	25 M points	1 s/div to 500 s/div	62.5 M points	5 s/div to 500 s/div	125 M points	5 s/div to 500 s/div	250 M points	10 s/div to 500 s/div
Specified Record Length	Time Scale																
1.25 M points or less	100 ms/div to 500 s/div																
6.25 M points	500 ms/div to 500 s/div																
12.5 M points	500 ms/div to 500 s/div																
25 M points	1 s/div to 500 s/div																
62.5 M points	5 s/div to 500 s/div																
125 M points	5 s/div to 500 s/div																
250 M points	10 s/div to 500 s/div																

## Signal Acquisition and Screen Display

Item	Specifications
Acquisition modes	Normal, Envelope, and Averaging. Normal: Normal sampling without special processing. Envelope: From the data sampled at the maximum real-time sample rate, the DLM4000 acquires the maximum and minimum values for each memory acquisition interval. Average: Averages normally sampled data over multiple acquisitions. Exponential averaging is performed when the trigger mode is set to Auto, Auto Level, or Normal, and linear averaging is performed when the trigger mode is set to Single. The trigger mode is handled as Normal when N Single is specified. The attenuation constant for exponential averaging and the linear average count can be set to a value from 2 to 1024 in 2 <sup>n</sup> steps. Averaging cannot be used on logic waveforms. For details on the trigger modes, see “Trigger modes” in section 6.2, “Triggering Section.”
Sampling modes	Real-time, repetitive, or interpolation sampling. When you use a short time scale that would cause the sample rate to exceed the real-time sampling maximum sample rate with the specified record length kept constant, the DLM4000 operates as follows: For the maximum sample rates, see “Maximum sample rate” in section 6.1, “Signal Input Section.” Realtime: Achieves the desired time scale by reducing the display record length. Interpolation: Performs interpolation sampling. If you decrease the time scale further and the upper limit of the interpolation sampling rate is exceeded, the DLM4000 reduces the display record length to achieve the desired time scale. Repetitive: Performs repetitive sampling. If you decrease the time scale further and the upper limit of the repetitive sampling rate is exceeded, the DLM4000 reduces the display record length to achieve the desired time scale.
High resolution mode	Improves the analog waveform S/N ratio by combining the high resolution mode and the digital filter. Improves the vertical resolution up to 12 bits.
Record lengths	Standard model: 1.25 k points, 12.5 k points, 125 k points, 1.25 M points, 6.25 M points (single ), 12.5 M points (interleave and single) /M1 option: 1.25 k points, 12.5 k points, 125 k points, 1.25 M points, 6.25 M points (single ), 62.5 M points (interleave and single) /M2 option: 1.25 k points, 12.5 k points, 125 k points, 1.25 M points, 12.5 M points, 62.5 M points (single), 125 M points (interleave and single) /M3 option: 1.25 k points, 12.5 k points, 125 k points, 1.25 M points, 6.25 M points, 12.5 M points, 25 M points, 62.5 M points (single), 125 M points (single), 250 M points (interleave and single)
History	Automatically saves history waveforms (past waveforms that have been acquired using the same acquisition conditions). Cannot be used in average mode, repetitive mode, or roll mode. Cannot be used at record lengths that only allow Single trigger mode. The maximum number of acquisitions that can be held is as follows: Standard model: Up to 2500 acquisitions (when the record length is set to 1.25 k points) /M1 option: Up to 10000 acquisitions (when the record length is set to 1.25 k points) /M2 option: Up to 20000 acquisitions (when the record length is set to 1.25 k points) /M3 option: Up to 50000 acquisitions (when the record length is set to 1.25 k points)

Item	Specifications
Zoom	<p>Expands waveforms vertically (analog waveforms only) and horizontally (along the time axis). Two locations, Zoom1 and Zoom2, can be expanded. Separate magnification settings can be specified for each location.</p> <p>Auto scrolling and searching are available as supplementary features of the zoom feature. For details on searching, see “Waveform Searching” described later.</p> <p>Vertical zoom</p> <p>Zoom source waveform: CH1 to CH8, Math1 to Math4</p> <p>Zoom position: The center position to zoom in on on the zoom source waveform can be specified.</p> <p>Selectable range: <math>\pm 4</math> div</p> <p>Zoom factor: The selectable range is 1 to 10.</p> <p>Time axis zoom</p> <p>Zoom position: The center position to zoom in on on the main waveform can be specified.</p> <p>Selectable range: <math>\pm 5</math> div</p> <p>Zoom factor: Can be set using the time scale magnification (ZOOM) knob. Press the ZOOM knob to switch between a mode in which you can set values in 1-2-5 steps or a mode in which you can set values in detail (FINE). The selectable range is from 2 or 2.5 to the magnification that corresponds to 2.5 points/10 div or 3.125 points/10 div. If the record length or time axis is changed, the DLM4000 retains the zoom factor as much as possible.</p> <p>Auto scroll feature: Automatically moves the zoom position in the specified direction.</p>
Display format	<p>Auto or 1, 2, 3, 4, 6, or 8 areas.</p> <p>When set to Auto, the DLM4000 to automatically select the number of areas depending on the number of displayed waveforms.</p> <p>The zoom windows can be divided into 1, 2, 3, 4, 6, or 8 areas or can be set to follow the main window setting. When a zoom window and the main window are displayed at the same time, you can set the vertical display area of the main window to 20% or 50%.</p>
Display interpolation	<p>Interpolation between sampled points can be set to sine interpolation, linear interpolation, pulse interpolation, or no interpolation.</p>
Grid	<p>The grid in the window can be set to dot grid, line grid, frame, and crosshair. Fine grid can be turned on and off.</p> <p>The normal grid appears in front of the waveforms, and the fine grid appears in the back of the waveforms.</p>
Auxiliary display on and off	<p>Waveform labels and scale values can be turned on and off. Waveform labels are assigned separately to channels.</p>
LCD backlight adjustment	<p>The LCD backlight can be turned off manually or automatically (automatically turns off when a specified time elapses with no key activity). The brightness can be adjusted.</p> <p>If the backlight is off, operating any key or knob turns on the backlight.</p> <p>The brightness level can be adjusted in the range of 1 to 10 (10 levels).</p>
X-Y display	<p>Four X-Y waveforms, XY1 to XY4, can be displayed.</p> <p>X-Y waveforms are displayed in their dedicated window and can be displayed simultaneously with T-Y waveforms.</p> <p>Specify the X-Trace, Y-Trace, and the X-Y display time range.</p> <p>XY1, XY2</p> <p>X-Trace: CH1 to CH4, Math1, Math2</p> <p>Y-Trace: CH1 to CH4, Math1, Math2</p> <p>XY3, XY4</p> <p>X-Trace: CH5 to CH8, Math3, Math4</p> <p>Y-Trace: CH5 to CH8, Math3, Math4</p> <p>Display range: <math>-5\text{div}</math> to <math>+5\text{div}</math> on the VT waveform display</p>
Accumulate	<p>Accumulates waveforms with gradually decreasing intensity for the specified amount of time. The accumulation time can be set to a value from 100 ms to 100 s or to infinite.</p> <p>Intensity and color modes can be selected.</p> <p>Intensity: Accumulates waveforms using separate channel colors with gradually decreasing intensity.</p> <p>Color: Displays the intensity that appears in intensity mode using different colors</p>
Snapshot	<p>The currently displayed waveforms can be retained on the screen.</p> <p>Snapshot waveforms can be saved and loaded.</p>
Clear trace	<p>Clears all displayed waveforms.</p>

## Computation, Analysis, and Searching

Item	Specifications
Computation	<p>Four computations can be performed, using MATH1 to MATH4.</p> <p>Waveform source waveforms are as follows:</p> <p>Math1: CH1 to CH4  Math2: CH1 to CH4, Math1  Math3: CH5 to CH8  Math4: CH5 to CH8, Math3</p> <p>The maximum computable record length is as follows:</p> <p>Standard model: 6.25 M points  /M1 option: 25 M points  /M2 option: 62.5 M points  /M3 option: 125 M points</p> <p>The following computation types are available.</p> <p>Standard model:</p> <p>Operators +, -, x, Filter, Integ, Count(Edge/Rotary)</p> <p>User-defined computation (/G2 or /G4 option):</p> <p>Expressions can be created by combining the following operators and constants.</p> <p>Operators: +, -, *, /, ABS, SQRT, LOG, LN, EXP, P2, SIN, ASIN, COS, ACOS, TAN, ATAN, PH, DIFF, INTEG, FILT1, FILT2, HLBT, MEAN, DELAY, BIN, PWHL, PWHL, PWLL, PWXX, FV, DUTYH, DUTYL, DA</p> <p>Constants: K1 to K4, 0 to 9, PI, e, fs, 1/fs, Exp, Measure</p>
FFT	<p>Two FFT (Fast Fourier Transform) waveforms, FFT1 and FFT2, can be displayed.</p> <p>Analysis source waveforms: CH1 to CH8, Math1 to Math4</p> <p>Analysis range: Main, Zoom1, Zoom2</p> <p>FFT Points: 1.25 k, 2.5 k, 12.5 k, 25 k, 125 k, 250 k points (samples the waveform in the analysis range using the specified number of FFT points)</p> <p>Time windows: Rectangular, Hanning, and flattop</p> <p>FFT waveform display modes: Normal, Max Hold, Average</p> <p>On models with the user-defined computation option, the FFT's Type and Sub type settings can be selected.</p> <p>Type: LS-, RS-, PS-, PSD-, CS-, TF-, CH-</p> <p>Sub type: MAG, LOGMAG, PHASE, REAL, IMAG</p>
Reference waveforms	<p>Four reference waveforms, REF1 to REF4, can be displayed</p> <p>Saved waveforms and channel waveforms can be loaded into REF1 to REF4.</p> <p>Ref1 to Ref4 use the Math1 to Math4 traces, respectively. Therefore, Ref and Math cannot be used simultaneously. Maximum record length at which reference waveforms can be used is the same as the maximum record length at which computation is possible. For details on the maximum computable record length, see "Computation" two items earlier.</p>
Waveform searching	<p>Searches the displayed waveform for locations that meet the specified conditions and displays the waveform expanded around the detected points. Up to 50000 points can be detected within the specified search range.</p> <p>Search start and end points: Can be set within <math>\pm 5</math> div. If the search type is not set to Edge or Pulse Width, End Point is fixed at +5 div.</p> <p>Search Types: Edge, Edge Qualified, State, Pulse Width, State Width</p>
Serial bus signal analysis*	<p>FlexRay, CAN, CAN FD (ISO 11898-1: 2015 or non-ISO), LIN, CXPI, SENT, PSI5 Airbag, UART, I<sup>2</sup>C, SPI, and user-defined serial bus data can be analyzed and displayed. The DLM4000 can decode frames, fields, and other information from the waveform displayed on the screen. Then, it can display the decoded results and the waveform together on the screen or display a list of detailed decoded results. For SENT and PSI5 Airbag signals, trend display is also possible.</p> <p>By performing a search, you can display an expanded waveform with the detected frame's or field's first data byte at the center of the window. The DLM4000 can analyze and search the waveforms of up to four serial bus signals. The DLM4000 can search up to 50000 points on the selected serial bus signal.</p>
History waveform display and searching	<p>You can display one waveform or all history waveforms overlapped and list the timestamps of the waveforms.</p> <p>You can search for waveforms that meet specified conditions, display detected history waveforms, and list the timestamps of the waveforms.</p> <p>Search conditions: Up to 4</p> <p>Search logic: Select Simple or the AND or OR of four search conditions. Simple sets the search condition to waveforms entering a rectangular zone.</p> <p>Search criterion: The source waveform enters the search range (IN), moves outside the search range (OUT), or don't care (X)</p> <p>Search range type: Select from the following:</p> <p>RectZone: Rectangular zone. Cannot be used on FFT waveforms.</p> <p>WaveZone: Waveform zone. Cannot be used on XY or FFT waveforms.</p> <p>PolygonZone: Polygonal zone. Cannot be used on FFT waveforms.</p> <p>Parameter: Zone between the upper and lower limits of one waveform parameter.</p>

\* FlexRay, CAN, CAN FD, LIN, CXPI, SENT, PSI5, UART, I<sup>2</sup>C, and SPI are options.



Item	Specifications
Cursor measurement	<p>Cursors can be placed on displayed waveforms to display the measured values between the cursors and waveforms.</p> <p>Select from the following cursors.</p> <p><math>\Delta T</math>, <math>\Delta V</math>, <math>\Delta T</math> &amp; <math>\Delta V</math>, Marker, Degree</p>
Automated measurement of waveform parameters	<p>The following waveform parameters can be automatically measured.</p> <p>Items that are measured over the entire specified range of data and are irrelevant to the period:</p> <p>Max, Min, P-P, High, Low, Amplitude, Rms, Mean, Sdev, IntegTY+, IntegTY, +Over, -Over, Pulse Count, Edge Count</p> <p>Items that are measured in the first period in the specified range:</p> <p>Freq, Period, Burst, +Width, -Width, Duty, Rise, Fall, Delay</p> <p>Items that are measured over all periods in the specified range:</p> <p>AvgFreq, AvgPeriod</p> <p><math>\Delta T</math> &amp; <math>\Delta V</math> cursor value:</p> <p>V1, V2, <math>\Delta T</math></p> <p>For logic signals, the following items are selectable.</p> <p>Freq, Period, AveFreq, Duty, Pulse Count, Delay</p> <p>In cycle mode, the following items are valid.</p> <p>Max, Min, P-P, High, Low, Amplitude, Rms, Mean, Sdev, IntegTY+, IntegTY, +Over, -Over</p> <p>The maximum total number of items that can be displayed in Area1 and Area2 on the screen is 30. Area1 indicates the area (the first area) for the normal automated measurement of waveform parameters. For details on Area2, see "Enhanced parameter measurement" described later.</p>
Statistical processing of waveform parameters	<p>For the automated measured values of waveform parameters, the following three types of statistical processing are available.</p> <p>Continuous: Calculates statistics on normal measurement that is performed multiple times.</p> <p>Cycle: Calculates statistics on the measurement of each period of the displayed waveform.</p> <p>History: Calculates statistics on the measurements of multiple history waveforms.</p> <p>The resultant statistics that are displayed are as follows:</p> <p>Max, Min, Mean, <math>\sigma</math>, Count</p> <p>The maximum total number of items that can be displayed in Area1 and Area2 on the screen is 9. For details on Area2, see "Enhanced parameter measurement" described later.</p>
Trend display and histogram display of waveform parameters	<p>Up to two trends or histograms of the specified measurement items can be displayed.</p> <p>The maximum total number of items that can be displayed in Area1 and Area2 on the screen is 9. For details on Area2, see "Enhanced parameter measurement" described later.</p>
Enhanced parameter measurement	<p>Performs automated measurement of waveform parameters on the second area (Area2).</p> <p>In addition to the normal waveform measurement range (Area1; described earlier), you can specify another measurement range (Area2). In addition, calculations can be performed using the automated measurement values of waveform parameters.</p> <p>The maximum total number of items that can be displayed in Area1 and Area2 on the screen is 30.</p>
Frequency distribution analysis	<p>Counts the frequency of data occurrence in a specified area and displays the values in a histogram. You can select whether to count the frequency on the vertical or time axis.</p> <p>The mean, standard deviation, maximum value, minimum value, peak value, median, etc., can be measured on the histogram.</p> <p>You can set up to two histogram source waveforms.</p>
Action-on-trigger	<p>A specific action can be executed when the DLM4000 triggers.</p> <p>You can set the number of times to execute the action on the basis of the number of waveform acquisitions or the number of determinations.</p> <p>Actions: Beeping, screen capture data printing or saving, waveform data saving, mail transmission</p>
GO/NO-GO determination	<p>A specific action can be executed when the GO/NO-GO result is NO-GO.</p> <p>You can set the number of times to execute the action on the basis of the number of waveform acquisitions or the number of determinations.</p> <p>Conditions: Up to 4 can be specified.</p> <p>Determination logic: Four conditions can be combined using AND or OR logic.</p> <p>Reference: The source waveform enters the reference range (IN), moves outside the search range (OUT), or don't care (X)</p> <p>Reference range type: Select from the following:</p> <p>RectZone: Rectangular zone. Cannot be used on FFT waveforms.</p> <p>WaveZone: Waveform zone. Cannot be used on XY or FFT waveforms.</p> <p>PolygonZone: Polygonal zone. Cannot be used on FFT waveforms.</p> <p>Parameter: Zone between the upper and lower limits of one waveform parameter.</p> <p>Actions: Beeping, screen capture data printing or saving, waveform data saving, mail transmission</p>

## 6.5 Features

Item	Specifications
Power supply analysis feature (/G3 or /G4 option)	<p>You can select and execute the analysis feature or power measurement feature.</p> <p>Analysis feature: Two of the following analyses can be executed simultaneously.</p> <ul style="list-style-type: none"> <li>Switching loss analysis (SW Loss): The total loss and the switching loss can be measured. Items such as power waveforms and measured values can be displayed, and statistics can be computed. The items whose switching losses can be measured automatically are listed below. Wp, Wp+, Wp-, Abs.Wp, P, P+, P-, Abs.P, Z</li> <li>Safe Operating Area (SOA): An X-Y display can be created with voltage input plotted on the X-axis and current input plotted on the Y-axis.</li> <li>Harmonic analysis (Harmonics): Simple comparisons can be made between the harmonics and standard limits. IEC 61000-3-2 Ed. 2.2, "Electromagnetic compatibility (EMC) - Part 3-2: Limits - Limits for harmonic current emissions (equipment input current ≤ 16 A per phase)" EN 61000-3-2 (2000) IEC 61000-4-7 Ed. 2</li> <li>Joule integral (I<sup>2</sup>t): Items such as Joule integral waveforms and measured values can be displayed, and statistics can be computed. The item whose Joule integral can be measured automatically is shown below. I<sup>2</sup>t</li> </ul> <p>Power measurement feature: The power of up to four circuits can be measured simultaneously. The items that can be measured automatically are shown below. U+pk, U-pk, Up-p, Udc, Uac, Urms, Umn, Urmn, Avg Freq (of voltage), I+pk, I-pk, Ip-p, Idc, Iac, Irms, Imn, Irmn, Avg Freq (of current), S, P, Q, Z, λ, Wp, Wp+, Wp-, Abs.Wp, q, q+, q-, Abs.q</p> <p>The auto deskew feature automatically deskews the time difference between the voltage and current waveforms. Auto deskew uses voltage and current signals of the deskew signal sources (701935 or 701936; sold separately) that are received through probes connected to voltage channels and current channels, respectively. For information about the deskew range, see "Deskewing" described earlier.</p>

## Screen Capture Data Printing and Saving

Item	Specifications
Built-in printer (/B5 option)	<p>Prints screen captures with the built-in printer.</p> <p>Print mode: Select from the following:</p> <ul style="list-style-type: none"> <li>Hardcopy: Prints the displayed screen image.</li> <li>Normal: Prints only the waveform area of the displayed screen image. The menu is not printed. If cursor measurements or automatically measured results are displayed, they are printed below the waveform area.</li> <li>Long: Prints a screen capture whose time axis is magnified 2 to 10 times. The menu is not printed. If cursor measurements or automatically measured results are displayed, they are printed below the waveform area.</li> </ul>
Network printer	<p>Prints screen captures on an external printer via Ethernet.</p> <p>Color can be turned on or off. Supports Epson inkjet printers, HP inkjet printers, and HP laser printers.</p> <p>Print mode: Select from the following:</p> <ul style="list-style-type: none"> <li>Hardcopy: Prints the displayed screen image.</li> <li>Normal: Prints only the waveform area of the displayed screen image. The menu is not printed. If cursor measurements or automatically measured results are displayed, they are printed below the waveform area.</li> </ul>
File	<p>Saves screen capture data to the specified storage medium using one of the following save modes. The storage medium can be set to internal memory or USB storage.</p> <p>Output data format can be set to PNG, BMP, or JPEG. Available color settings are OFF, ON, ON (Rev), and ON (Gray).</p> <p>Save mode: Select from the following:</p> <ul style="list-style-type: none"> <li>Hardcopy: Saves the displayed screen image.</li> <li>Normal: Saves only the waveform area of the displayed screen image. The menu is not saved. If cursor measurements or automatically measured results are displayed, they are printed below the waveform area.</li> <li>Wide: Saves a screen capture whose time axis is magnified twice. The menu is not saved. If cursor measurements or automatically measured results are displayed, they are printed below the waveform area.</li> </ul>

## Data Storage

Item	Specifications
Waveform data	<p>Saves waveform data (including history waveforms) to the specified storage medium.* The saved data can be loaded into the DLM4000.</p> <p>Available data formats are binary (.wdf) and ASCII (.csv). Only binary (.wdf) files can be loaded into the DLM4000.</p> <p>When saving waveform data, specify the data format, the waveform to save, the history range, the window to be saved (Main, Zoom1, or Zoom2), and the compression method (OFF, P-P, or Decimation).</p> <p>When loading waveform data, set the load destination to the acquisition memory (channel), Ref1 (Math1) to Ref4 (Math4).</p> <p>If waveform data is loaded into the acquisition memory, the data is cleared when you start waveform acquisition.</p>
Setup data	Setup data can be saved to the specified storage medium.* The saved data can be loaded into the DLM4000.
Setup data (storage and recall)	Up to three sets of setup data can be stored and loaded from the internal memory.
Other types of data	The displayed screen image can be saved. Waveform zones can be saved and loaded. Polygonal zones can be loaded. Snapshot waveforms can be saved and loaded. Automatically measured waveform parameters can be saved. Serial bus analysis results can be saved. FFT waveform data can be saved. Histogram data can be saved. A list of timestamps of history waveforms can be saved.

\* The storage medium can be set to internal memory or USB storage.

## Other Features

Item	Specifications
Default setup	<p>Resets the DLM4000 to its factory default settings.</p> <p>The following settings are not reset: date and time settings, communication interface settings, settings stored to the internal memory, language settings, and font size of measured values.</p> <p>The Undo command can be used to revert to the previous settings.</p>
Auto setup	<p>Automatically sets the voltage scale, time scale, trigger, and other settings to the most suitable values for the input signals.</p> <p>The Undo command can be used to revert to the previous settings.</p>
Serial bus auto setup*	Auto setup can be executed on the basis of the selected serial bus type (FlexRay, CAN, CAN FD, LIN, CXPI, SENT, PSI5 Airbag, UART, I <sup>2</sup> C, or SPI) and trigger source. The DLM4000 can automatically set the bit rate, source level, and other settings and trigger on the basis of these settings.
Calibration	Auto calibration and manual calibration are available.
System settings	The date, time, and message language can be specified. The click sound can be turned on and off.
Probe compensation signal output	Transmits signals from the front-panel probe compensation signal output terminals (approx. 1-Vp-p and approx. 1-kHz rectangular wave).
Overview	Allows you to view the DLM4000 system status.
Additional option license	Trigger, computation, and analysis options can be added.
Self-tests	Memory, accuracy, keyboard, and printer tests are available.
Help	Displays a description of the settings.

\* On models with the serial bus option.

## 6.6 Built-in Printer (/B5 Option)

Item	Specifications
Print system	Thermal line dot system
Dot density	8 dots/mm
Sheet width	112 mm

## 6.7 Storage

### Internal Memory

Item	Specifications
Media type	SD memory card
Memory size	Standard model: Approx. 1.8 GB /C8 option: Approx. 7.2 GB

### USB Storage Device

Item	Specifications
Compatible USB storage devices	Mass storage device compatible with USB Mass Storage Class Ver. 1.1
Available space	2 TB Partition format: MBR, format type: FAT32/FAT16

\* See section 6.8, "USB for Peripherals."

## 6.8 USB Ports for Peripherals

Item	Specifications
Connector type	USB type A (receptacle)
Electrical and mechanical specifications	USB Rev. 2.0 compliant
Supported transfer mode	LS (Low Speed; 1.5 Mbps), FS (Full Speed; 12 Mbps), HS (High Speed; 480 Mbps)
Ports	2
Power supply	5 V, 500 mA (for each port)
Compatible devices	Mouse devices that comply with USB HID Class Ver. 1.1 104 or 109 (Japanese) keyboards that comply with USB HID Class Ver. 1.1 Mass storage device compatible with USB Mass Storage Class Ver. 1.1 USB HUB device
No. of connectable devices	Hub: 1 per port Mouse and keyboard: 1 each Mass storage devices: 4 Up to six devices can be connected including the hub



## 6.9 Auxiliary I/O Section

### External Trigger Input (TRIG IN)

Item	Specifications
Connector type	BNC
Input bandwidth*	DC to 100 MHz
Input impedance	Approx. 1 k $\Omega$ , approx. 20 pF
Maximum input voltage	$\pm 40$ V (DC + ACpeak) or 28 Vrms (At 1 MHz and higher, the voltage decreases at 20 dB/decade down to $\pm 5$ V (DC+ACpeak) or 3.5 Vrms.)
Input range	$\pm 2$ V
Trigger level	$\pm 2$ V. The resolution is 5 mV.

\* Values measured under standard operating conditions (see section 6.11 for details) after a 30-minute warm-up.

### Trigger Out (TRIGGER OUT)

Item	Specifications
Connector type	BNC
Output level	3.3 V CMOS
Output impedance	Approx. 50 $\Omega$
Output logic	Negative logic (  ) and positive logic (  ) switchable
Output delay	50 ns or less
Output hold time	Negative logic: Low level: 800 ns min. High level: 50 ns min. Positive logic: High level: 800 ns min. Low level: 50 ns min.

### Front Panel Probe Interface Terminal

Item	Specifications
Output terminals	8
Output voltage	$\pm 12$ V (up to 2.0 A in combination with the side-panel probe power terminal), $\pm 5$ V (up to 1.6 A total)
Usable probes	Active probes (701912, 701913, 701914), differential probes (701923, 701924, 701927), current probes (701928, 701929)

### Side Panel Probe Power Terminal (/P8 Option)

Item	Specifications
Output terminals	8
Output voltage	$\pm 12$ V (up to 2.0 A in combination with the probe power terminal)
Usable probes and deskew signal sources	FET probe (700939), current probe (701930, 701931, 701932, 701933), differential probes (700924, 700925, 701920, 701921, 701922, 701926), deskew signal source (701936)

### GO/NO-GO Output

Item	Specifications
Connector type	RJ-12 modular jack
Output signal	GO OUT, NO-GO OUT
Output level	TTL compatible
Compliant cable	Four-wire modular cable

### Video Signal Output (VIDEO OUT)

Item	Specifications
Connector type	D-sub 15 pin (receptacle)
Output type	Analog RGB output
Output resolution	XGA-compliant output, 1024 $\times$ 768 dots, approx. 60-Hz Vsync (62.5 MHz dot clock frequency)

## 6.10 Computer Interface

### GP-IB (/C1 Option)

Item	Specifications
Electrical and mechanical specifications	Complies with IEEE St'd 488-1978 (JIS C 1901-1987)
Functional specifications	SH1, AH1, T6, L4, SR1, RL1, PP0, DC1, DT0, C0
Protocol	Complies with IEEE St'd 488.2-1992
Code	ISO (ASCII) codes
Mode	Addressable mode
Addresses	Talker and listener addresses can be specified from 0 to 30.
Clearing remote mode	Remote mode can be cleared with the SHIFT+CLEAR TRACE key (except during Local Lockout).

### USB for PC Connection

Item	Specifications
Connector type	USB type B (receptacle)
Electrical and mechanical specifications	USB Rev. 2.0 compliant
Supported transfer mode	FS (Full Speed; 12 Mbps), HS (High Speed; 480 Mbps)
Ports	1
Supported protocols	Functions as a device that conforms to one of the following two protocols. USBTMC-USB488(USB Test and Measurement Class Ver. 1.0)* GP-IB commands can be used through USB. Mass Storage Class Ver.1.1 Only reading is possible from the DLM4000 internal memory through PC access. (Operations, such as formatting, are not possible.)
PC system requirements	A PC running the English or Japanese version of Windows 7 (32bit, 64bit), Windows 8 (32bit, 64bit), Windows 8.1 (32bit, 64bit), or Windows 10 (32bit, 64bit)

\* A separate driver is required.

### Ethernet Interface

Item	Specifications
Connector type	RJ-45
Ports	1
Electrical and mechanical specifications	IEEE 802.3 compliant
Transmission system	Ethernet (1000BASE-T, 100BASE-TX, 10BASE-T)
Communication protocol	TCP/IP
Supported services	Server: FTP, HTTP (Web), and VXI-11 Client: FTP (Net Drive), SMTP (Mail), SNTP, LPR (Net Print), DHCP, and DNS
PC system requirements	A PC running the English or Japanese version of Windows 7 (32bit, 64bit), Windows 8 (32bit, 64bit), Windows 8.1 (32bit, 64bit), or Windows 10 (32bit, 64bit)

## 6.11 General Specifications

Item	Specifications
Standard operating conditions	Ambient temperature: 23 ± 5°C Ambient humidity: 55%RH ± 10% RH Supply voltage and frequency errors: Within 1% of rating
Warm-up time	At least 30 minutes
Storage environment	Temperature: -20°C to 60°C Humidity: 20%RH to 80%RH (no condensation) Altitude: 3000m or less
Operating environment	Temperature: 5°C to 40°C Humidity: 20%RH to 80%RH (when the printer is not used; no condensation) 35%RH to 80%RH (when the printer is used; no condensation) Altitude: 2000 m or less
Recommended calibration period	1 year
Rated supply voltage	100 VAC to 240 VAC
Permitted supply voltage range	90 VAC to 264 VAC
Rated power supply frequency	50/60 Hz
Permitted power supply frequency range	48 Hz to 63 Hz
Power fuse	Built in (not replaceable)
Maximum power consumption	250 VA (when the printer is used)
Withstand voltage (between the power supply and case)	1.5 kVAC for 1 minute
Insulation resistance (between the power supply and case)	500 VDC, 10 MΩ or more
External dimensions	426 mm (W) × 266 mm (H) × 178 mm (D) when the printer cover is closed; excluding protrusions
Weight	Approx. 6.6 kg (excluding options)
Instrument cooling method	Forced air cooling; outlet on the rear
Installation orientation	Horizontal or tilted using the movable leg or stand Other orientations are prohibited. Stacking prohibited.
Battery backup	The clock is backed up with the internal lithium battery. Battery life: Approx. five years (at an ambient temperature of 25°C)

## 6.11 General Specifications

Item	Specifications
Safety standards	<p>Compliant standard</p> <p>EN 61010-1</p> <p>Overvoltage Category II<sup>1</sup></p> <p>Pollution Degree 2<sup>2</sup></p> <p>EN 61010-2-030</p> <p>Measurement Category Other (O)<sup>3</sup></p>
Emissions	<p>Compliant standards</p> <p>EN 61326-1 Class A</p> <p>EN 61326-2-1</p> <p>EN 55011 Class A, Group 1</p> <p>EMC Regulatory Arrangement in Australia and New Zealand EN 55011 Class A, Group 1</p> <p>Korea Electromagnetic Conformity Standard ( 한국 전자파적합성기준 )</p> <p>(Applicable to the DLM4038 and DLM4058)</p> <p>EN 61000-3-2</p> <p>EN 61000-3-3</p> <p>This is a class A instrument designed for an industrial environment. Operation of this equipment in a residential area may cause radio interference, in which case users will be required to correct the interference.</p> <p>Cable conditions</p> <p>Trigger output (TRIGGER OUT) terminal</p> <p>Use a BNC cable that is 3 m or less in length.</p> <p>Video signal output (VIDEO OUT) terminal</p> <p>Use a shielded D-Sub 15-pin VGA cable that is 3 m or less in length.</p> <p>GP-IB connector</p> <p>Use a shielded cable that is 3 m in length or less.</p> <p>Ethernet port (ETHERNET)</p> <p>Use Ethernet cables that are 30 m or less in length.</p> <p>USB port for peripherals</p> <p>Attach a ferrite core (TDK: ZCAT1325-0530A, YOKOGAWA: A1181MN) to the DLM4000 end of a USB cable. Use cables that are 3 m or less in length.</p> <p>USB port for PCs</p> <p>Attach a ferrite core (TDK: ZCAT1325-0530A, YOKOGAWA: A1181MN) to the DLM4000 end of a USB cable. Use cables that are 3 m or less in length.</p> <p>Probe power terminal</p> <p>Attach a ferrite core (TDK: ZCAT1325-0530A, YOKOGAWA: A1181MN) to the DLM4000 end of the B9852MJ dedicated power cable, which is sold separately.</p> <p>GO/NO-GO output terminal</p> <p>Use the dedicated GO/NO-GO cable (YOKOGAWA: 366973), which is sold separately. Attach a ferrite-core (TDK: ZCAT2035-0930A, YOKOGAWA: A1190MN) to the DLM4000 end of the cable by passing the cable twice through the core (see the figure below).</p>

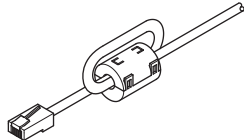

- The overvoltage category (installation category) is a value used to define the transient overvoltage condition and includes the rated impulse withstand voltage. The overvoltage category II applies to electrical equipment that is powered through a fixed installation, such as a switchboard.
- The pollution degree refers to the degree of adhesion of a solid, liquid, or gas which deteriorates withstand voltage or surface resistivity. Pollution degree 2 applies to normal indoor atmospheres (with only non-conductive pollution).
- The measurement category of the DLM4000 signal input terminals is Other (O). Do not use it to measure the main power supply or for Measurement Categories II, III, and IV.
 

Measurement category Other (O) applies to measurement of circuits that are not directly connected to a main power supply. This category applies to measurement of secondary electric circuits in equipment across a transformer. The estimated transient overvoltage that may be applied to the DLM4000 signal input terminals is 1500 V.

Measurement category II applies to measurement of circuits, such as household electric appliances and portable electric tools, that are connected to low-voltage installations.

Measurement category III applies to measurement of facility circuits, such as distribution boards and circuit breakers.

Measurement category IV applies to measurement of power source circuits, such as entrance cables to buildings and cable systems, for low-voltage installations.



Item	Specifications
Immunity	<p data-bbox="496 262 692 282">Compliant standards</p> <p data-bbox="517 286 999 306">EN 61326-1 Table 2 (for use in industrial locations)</p> <p data-bbox="517 311 651 331">EN 61326-2-1</p> <p data-bbox="517 336 930 356">(Applicable to the DLM4038 and DLM4058)</p> <hr/> <p data-bbox="496 367 1027 387">Influence in the immunity testing environment (criteria A)</p> <p data-bbox="517 392 1102 412">Noise increase: <math>\pm 50</math> mV or <math>\pm 2</math> div, whichever is greater</p> <p data-bbox="517 416 986 436">Test conditions: 1.25 GS/s, envelope mode</p> <p data-bbox="517 441 1107 461">Cable conditions: Same as the emission cable conditions.</p> <p data-bbox="517 465 1302 837">Test items:</p> <ol style="list-style-type: none"> <li data-bbox="730 477 1302 533">1. Static discharge: EN 61000-4-2 Air discharge: <math>\pm 8</math> kV. Contact discharge: <math>\pm 4</math> kV. Criteria B.</li> <li data-bbox="730 537 1270 593">2. Radiated immunity: EN 61000-4-3 80 M to 1 GHz, 10 V/m, 1.4 to 4 GHz, 3 V/m, criteria A</li> <li data-bbox="730 598 1098 654">3. Conducted immunity: EN 61000-4-6 3 V, criteria A</li> <li data-bbox="730 658 1193 714">4. EFT/Burst: EN 61000-4-4 Power line: <math>\pm 2</math> kV. Signal line: <math>\pm 1</math> kV, criteria B</li> <li data-bbox="730 719 1198 775">5. Surge immunity: EN 61000-4-5 <math>\pm 1</math> kV between lines, <math>\pm 2</math> kV common, criteria B</li> <li data-bbox="730 779 1182 837">6. Voltage dip and interruptions: EN 61000-4-11 1 cycle, both polarities, 100%, criteria B Other tests, criteria C</li> </ol> <p data-bbox="730 842 1038 862">Definitions of criteria A, B, and C</p> <p data-bbox="751 866 1329 922">Criteria A: During testing, "influence in the immunity testing environment" described above is met.</p> <p data-bbox="751 927 1398 1005">Criteria B: The instrument continues to function and is controllable throughout testing. The instrument does not change operation modes, and data changes do not persist.</p> <p data-bbox="751 1010 1398 1088">Criteria C: During testing, temporary degradation of performance or loss of functionality occurred, the correction of which required user operation or system reset.</p>
Environmental standard	<p data-bbox="496 1093 683 1113">Compliant standard</p> <p data-bbox="517 1117 1350 1167">EN 50581 Monitoring and control instruments including industrial monitoring and control instruments.</p>

## 6.12 External Dimensions

### Instrument

Unit: mm

Unless otherwise specified, tolerances are  $\pm 3\%$  (however, tolerances are  $\pm 0.3$  mm when below 10 mm).

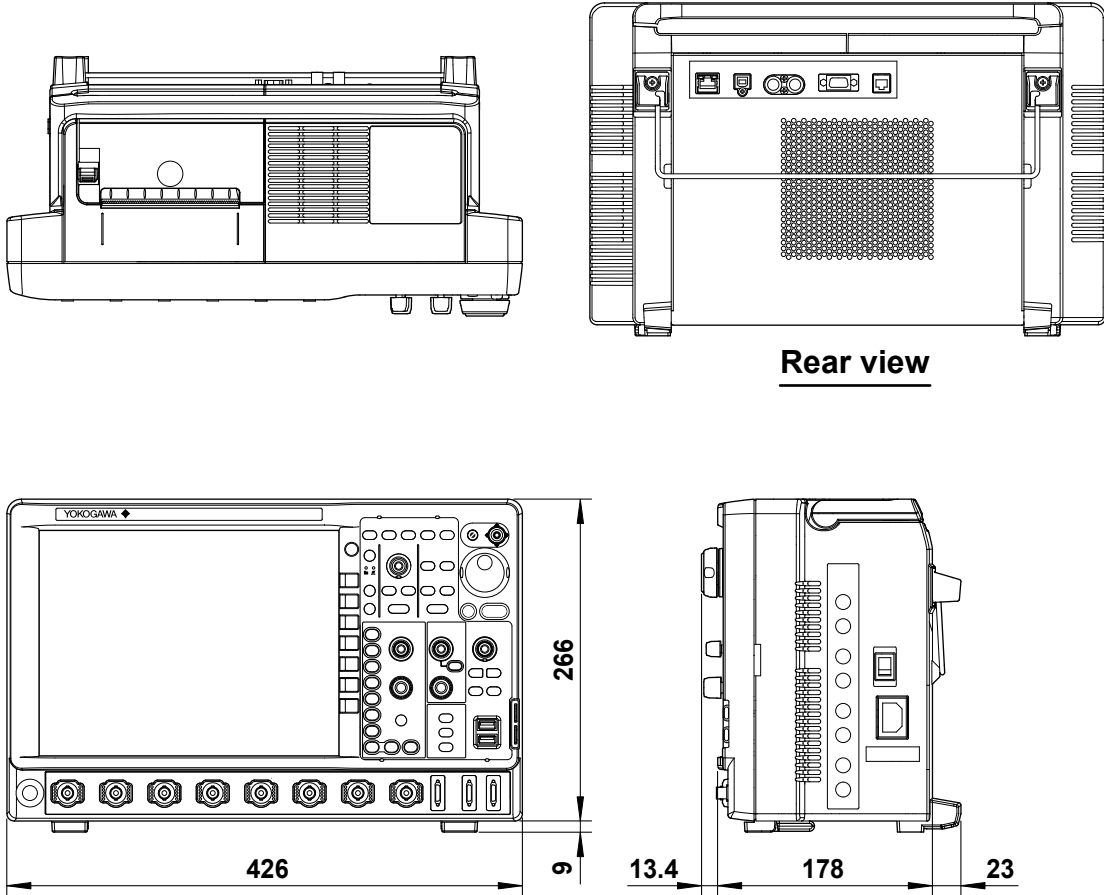

# Appendix 1 Relationship between the Time Axis Setting, Record Length, and Sample Rate

## When the Record Length Is 1.25 k points

(This record length can be selected on all models)

IntP: Interpolation Mode

Rep: Repetitive Sampling Mode

Settings Time/div	When High Resolution mode is off								When High Resolution mode is on							
	When Interleave mode is off				When Interleave mode is on				When Interleave mode is off				When Interleave mode is on			
	Realtime		IntP/Rep		Realtime		IntP/Rep		Realtime		IntP/Rep		Realtime		IntP/Rep	
	Sample Rate (S/s)	Record Length (Points)	Sample Rate (S/s)	Record Length (Points)	Sample Rate (S/s)	Record Length (Points)	Sample Rate (S/s)	Record Length (Points)	Sample Rate (S/s)	Record Length (Points)	Sample Rate (S/s)	Record Length (Points)	Sample Rate (S/s)	Record Length (Points)	Sample Rate (S/s)	Record Length (Points)
500 s	50	250 k	50	250 k	50	250 k	50	250 k	50	250 k	50	250 k	50	250 k	50	250 k
200 s	50	100 k	50	100 k	50	100 k	50	100 k	50	100 k	50	100 k	50	100 k	50	100 k
100 s	50	50 k	50	50 k	50	50 k	50	50 k	50	50 k	50	50 k	50	50 k	50	50 k
50 s	50	25 k	50	25 k	50	25 k	50	25 k	50	25 k	50	25 k	50	25 k	50	25 k
20 s	50	10 k	50	10 k	50	10 k	50	10 k	50	10 k	50	10 k	50	10 k	50	10 k
10 s	50	5 k	50	5 k	50	5 k	50	5 k	50	5 k	50	5 k	50	5 k	50	5 k
5 s	50	2.5 k	50	2.5 k	50	2.5 k	50	2.5 k	50	2.5 k	50	2.5 k	50	2.5 k	50	2.5 k
2 s	62.5	1.25 k	62.5	1.25 k	62.5	1.25 k	62.5	1.25 k	62.5	1.25 k	62.5	1.25 k	62.5	1.25 k	62.5	1.25 k
1 s	125	1.25 k	125	1.25 k	125	1.25 k	125	1.25 k	125	1.25 k	125	1.25 k	125	1.25 k	125	1.25 k
500 ms	250	1.25 k	250	1.25 k	250	1.25 k	250	1.25 k	250	1.25 k	250	1.25 k	250	1.25 k	250	1.25 k
200 ms	625	1.25 k	625	1.25 k	625	1.25 k	625	1.25 k	625	1.25 k	625	1.25 k	625	1.25 k	625	1.25 k
100 ms	1.25 k	1.25 k	1.25 k	1.25 k	1.25 k	1.25 k	1.25 k	1.25 k	1.25 k	1.25 k	1.25 k	1.25 k	1.25 k	1.25 k	1.25 k	1.25 k
50 ms	2.5 k	1.25 k	2.5 k	1.25 k	2.5 k	1.25 k	2.5 k	1.25 k	2.5 k	1.25 k	2.5 k	1.25 k	2.5 k	1.25 k	2.5 k	1.25 k
20 ms	6.25 k	1.25 k	6.25 k	1.25 k	6.25 k	1.25 k	6.25 k	1.25 k	6.25 k	1.25 k	6.25 k	1.25 k	6.25 k	1.25 k	6.25 k	1.25 k
10 ms	12.5 k	1.25 k	12.5 k	1.25 k	12.5 k	1.25 k	12.5 k	1.25 k	12.5 k	1.25 k	12.5 k	1.25 k	12.5 k	1.25 k	12.5 k	1.25 k
5 ms	25 k	1.25 k	25 k	1.25 k	25 k	1.25 k	25 k	1.25 k	25 k	1.25 k	25 k	1.25 k	25 k	1.25 k	25 k	1.25 k
2 ms	62.5 k	1.25 k	62.5 k	1.25 k	62.5 k	1.25 k	62.5 k	1.25 k	62.5 k	1.25 k	62.5 k	1.25 k	62.5 k	1.25 k	62.5 k	1.25 k
1 ms	125 k	1.25 k	125 k	1.25 k	125 k	1.25 k	125 k	1.25 k	125 k	1.25 k	125 k	1.25 k	125 k	1.25 k	125 k	1.25 k
500 μs	250 k	1.25 k	250 k	1.25 k	250 k	1.25 k	250 k	1.25 k	250 k	1.25 k	250 k	1.25 k	250 k	1.25 k	250 k	1.25 k
200 μs	625 k	1.25 k	625 k	1.25 k	625 k	1.25 k	625 k	1.25 k	625 k	1.25 k	625 k	1.25 k	625 k	1.25 k	625 k	1.25 k
100 μs	1.25 M	1.25 k	1.25 M	1.25 k	1.25 M	1.25 k	1.25 M	1.25 k	1.25 M	1.25 k	1.25 M	1.25 k	1.25 M	1.25 k	1.25 M	1.25 k
50 μs	2.5 M	1.25 k	2.5 M	1.25 k	2.5 M	1.25 k	2.5 M	1.25 k	2.5 M	1.25 k	2.5 M	1.25 k	2.5 M	1.25 k	2.5 M	1.25 k
20 μs	6.25 M	1.25 k	6.25 M	1.25 k	6.25 M	1.25 k	6.25 M	1.25 k	6.25 M	1.25 k	6.25 M	1.25 k	6.25 M	1.25 k	6.25 M	1.25 k
10 μs	12.5 M	1.25 k	12.5 M	1.25 k	12.5 M	1.25 k	12.5 M	1.25 k	12.5 M	1.25 k	12.5 M	1.25 k	12.5 M	1.25 k	12.5 M	1.25 k
5 μs	25 M	1.25 k	25 M	1.25 k	25 M	1.25 k	25 M	1.25 k	25 M	1.25 k	25 M	1.25 k	25 M	1.25 k	25 M	1.25 k
2 μs	62.5 M	1.25 k	62.5 M	1.25 k	62.5 M	1.25 k	62.5 M	1.25 k	62.5 M	1.25 k	62.5 M	1.25 k	62.5 M	1.25 k	62.5 M	1.25 k
1 μs	125 M	1.25 k	125 M	1.25 k	125 M	1.25 k	125 M	1.25 k	125 M	1.25 k	125 M	1.25 k	125 M	1.25 k	125 M	1.25 k
500 ns	250 M	1.25 k	250 M	1.25 k	250 M	1.25 k	250 M	1.25 k	250 M	1.25 k	250 M	1.25 k	250 M	1.25 k	250 M	1.25 k
200 ns	625 M	1.25 k	625 M	1.25 k	625 M	1.25 k	625 M	1.25 k	625 M	1.25 k	625 M	1.25 k	625 M	1.25 k	625 M	1.25 k
100 ns	1.25 G	1.25 k	1.25 G	1.25 k	1.25 G	1.25 k	1.25 G	1.25 k	625 M	625	1.25 G	1.25 k	1.25 G	1.25 k	1.25 G	1.25 k
50 ns	1.25 G	625	2.5 G	1.25 k	2.5 G	1.25 k	2.5 G	1.25 k	625 M	312.5	2.5 G	1.25 k	1.25 G	625	2.5 G	1.25 k
20 ns	1.25 G	250	6.25 G	1.25 k	2.5 G	500	6.25 G	1.25 k	625 M	125	6.25 G	1.25 k	1.25 G	250	6.25 G	1.25 k
10 ns	1.25 G	125	12.5 G	1.25 k	2.5 G	250	12.5 G	1.25 k	625 M	62.5	12.5 G	1.25 k	1.25 G	125	12.5 G	1.25 k
5 ns	1.25 G	62.5	25 G	1.25 k	2.5 G	125	25 G	1.25 k	625 M	31.25	25 G	1.25 k	1.25 G	62.5	25 G	1.25 k
2 ns	1.25 G	25	62.5 G	1.25 k	2.5 G	50	62.5 G	1.25 k	625 M	12.5	62.5 G	1.25 k	1.25 G	25	62.5 G	1.25 k
1 ns	1.25 G	12.5	125 G	1.25 k	2.5 G	25	125 G	1.25 k	625 M	6.25	125 G	1.25 k	1.25 G	12.5	125 G	1.25 k

Values outside of the thick borders have been calculated in real-time sampling mode.

 : Roll Mode

**Appendix 1 Relationship between the Time Axis Setting, Record Length, and Sample Rate**

**When the Record Length Is 12.5 k points**

(This record length can be selected on all models)

IntP: Interpolation Mode  
Rep: Repetitive Sampling Mode

Settings  Time/div	When High Resolution mode is off								When High Resolution mode is on							
	When Interleave mode is off				When Interleave mode is on				When Interleave mode is off				When Interleave mode is on			
	Realtime		IntP/Rep		Realtime		IntP/Rep		Realtime		IntP/Rep		Realtime		IntP/Rep	
	Sample Rate (S/s)	Record Length (Points)	Sample Rate (S/s)	Record Length (Points)	Sample Rate (S/s)	Record Length (Points)	Sample Rate (S/s)	Record Length (Points)	Sample Rate (S/s)	Record Length (Points)	Sample Rate (S/s)	Record Length (Points)	Sample Rate (S/s)	Record Length (Points)	Sample Rate (S/s)	Record Length (Points)
500 s	50	250 k	50	250 k	50	250 k	50	250 k	50	250 k	50	250 k	50	250 k	50	250 k
200 s	50	100 k	50	100 k	50	100 k	50	100 k	50	100 k	50	100 k	50	100 k	50	100 k
100 s	50	50 k	50	50 k	50	50 k	50	50 k	50	50 k	50	50 k	50	50 k	50	50 k
50 s	50	25 k	50	25 k	50	25 k	50	25 k	50	25 k	50	25 k	50	25 k	50	25 k
20 s	62.5	12.5 k	62.5	12.5 k	62.5	12.5 k	62.5	12.5 k	62.5	12.5 k	62.5	12.5 k	62.5	12.5 k	62.5	12.5 k
10 s	125	12.5 k	125	12.5 k	125	12.5 k	125	12.5 k	125	12.5 k	125	12.5 k	125	12.5 k	125	12.5 k
5 s	250	12.5 k	250	12.5 k	250	12.5 k	250	12.5 k	250	12.5 k	250	12.5 k	250	12.5 k	250	12.5 k
2 s	625	12.5 k	625	12.5 k	625	12.5 k	625	12.5 k	625	12.5 k	625	12.5 k	625	12.5 k	625	12.5 k
1 s	1.25 k	12.5 k	1.25 k	12.5 k	1.25 k	12.5 k	1.25 k	12.5 k	1.25 k	12.5 k	1.25 k	12.5 k	1.25 k	12.5 k	1.25 k	12.5 k
500 ms	2.5 k	12.5 k	2.5 k	12.5 k	2.5 k	12.5 k	2.5 k	12.5 k	2.5 k	12.5 k	2.5 k	12.5 k	2.5 k	12.5 k	2.5 k	12.5 k
200 ms	6.25 k	12.5 k	6.25 k	12.5 k	6.25 k	12.5 k	6.25 k	12.5 k	6.25 k	12.5 k	6.25 k	12.5 k	6.25 k	12.5 k	6.25 k	12.5 k
100 ms	12.5 k	12.5 k	12.5 k	12.5 k	12.5 k	12.5 k	12.5 k	12.5 k	12.5 k	12.5 k	12.5 k	12.5 k	12.5 k	12.5 k	12.5 k	12.5 k
50 ms	25 k	12.5 k	25 k	12.5 k	25 k	12.5 k	25 k	12.5 k	25 k	12.5 k	25 k	12.5 k	25 k	12.5 k	25 k	12.5 k
20 ms	62.5 k	12.5 k	62.5 k	12.5 k	62.5 k	12.5 k	62.5 k	12.5 k	62.5 k	12.5 k	62.5 k	12.5 k	62.5 k	12.5 k	62.5 k	12.5 k
10 ms	125 k	12.5 k	125 k	12.5 k	125 k	12.5 k	125 k	12.5 k	125 k	12.5 k	125 k	12.5 k	125 k	12.5 k	125 k	12.5 k
5 ms	250 k	12.5 k	250 k	12.5 k	250 k	12.5 k	250 k	12.5 k	250 k	12.5 k	250 k	12.5 k	250 k	12.5 k	250 k	12.5 k
2 ms	625 k	12.5 k	625 k	12.5 k	625 k	12.5 k	625 k	12.5 k	625 k	12.5 k	625 k	12.5 k	625 k	12.5 k	625 k	12.5 k
1 ms	1.25 M	12.5 k	1.25 M	12.5 k	1.25 M	12.5 k	1.25 M	12.5 k	1.25 M	12.5 k	1.25 M	12.5 k	1.25 M	12.5 k	1.25 M	12.5 k
500 μs	2.5 M	12.5 k	2.5 M	12.5 k	2.5 M	12.5 k	2.5 M	12.5 k	2.5 M	12.5 k	2.5 M	12.5 k	2.5 M	12.5 k	2.5 M	12.5 k
200 μs	6.25 M	12.5 k	6.25 M	12.5 k	6.25 M	12.5 k	6.25 M	12.5 k	6.25 M	12.5 k	6.25 M	12.5 k	6.25 M	12.5 k	6.25 M	12.5 k
100 μs	12.5 M	12.5 k	12.5 M	12.5 k	12.5 M	12.5 k	12.5 M	12.5 k	12.5 M	12.5 k	12.5 M	12.5 k	12.5 M	12.5 k	12.5 M	12.5 k
50 μs	25 M	12.5 k	25 M	12.5 k	25 M	12.5 k	25 M	12.5 k	25 M	12.5 k	25 M	12.5 k	25 M	12.5 k	25 M	12.5 k
20 μs	62.5 M	12.5 k	62.5 M	12.5 k	62.5 M	12.5 k	62.5 M	12.5 k	62.5 M	12.5 k	62.5 M	12.5 k	62.5 M	12.5 k	62.5 M	12.5 k
10 μs	125 M	12.5 k	125 M	12.5 k	125 M	12.5 k	125 M	12.5 k	125 M	12.5 k	125 M	12.5 k	125 M	12.5 k	125 M	12.5 k
5 μs	250 M	12.5 k	250 M	12.5 k	250 M	12.5 k	250 M	12.5 k	250 M	12.5 k	250 M	12.5 k	250 M	12.5 k	250 M	12.5 k
2 μs	625 M	12.5 k	625 M	12.5 k	625 M	12.5 k	625 M	12.5 k	625 M	12.5 k	625 M	12.5 k	625 M	12.5 k	625 M	12.5 k
1 μs	1.25 G	12.5 k	1.25 G	12.5 k	1.25 G	12.5 k	1.25 G	12.5 k	625 M	6.25 k	1.25 G	12.5 k	1.25 G	12.5 k	1.25 G	12.5 k
500 ns	1.25 G	6.25 k	2.5 G	12.5 k	2.5 G	12.5 k	2.5 G	12.5 k	625 M	3.125 k	2.5 G	12.5 k	1.25 G	6.25 k	2.5 G	12.5 k
200 ns	1.25 G	2.5 k	6.25 G	12.5 k	2.5 G	5 k	6.25 G	12.5 k	625 M	1.25 k	6.25 G	12.5 k	1.25 G	2.5 k	6.25 G	12.5 k
100 ns	1.25 G	1.25 k	12.5 G	12.5 k	2.5 G	2.5 k	12.5 G	12.5 k	625 M	625	12.5 G	12.5 k	1.25 G	1.25 k	12.5 G	12.5 k
50 ns	1.25 G	625	25 G	12.5 k	2.5 G	1.25 k	25 G	12.5 k	625 M	312.5	25 G	12.5 k	1.25 G	625	25 G	12.5 k
20 ns	1.25 G	250	62.5 G	12.5 k	2.5 G	500	62.5 G	12.5 k	625 M	125	62.5 G	12.5 k	1.25 G	250	62.5 G	12.5 k
10 ns	1.25 G	125	125 G	12.5 k	2.5 G	250	125 G	12.5 k	625 M	62.5	125 G	12.5 k	1.25 G	125	125 G	12.5 k
5 ns	1.25 G	62.5	125 G	6.25 k	2.5 G	125	125 G	6.25 k	625 M	31.25	125 G	6.25 k	1.25 G	62.5	125 G	6.25 k
2 ns	1.25 G	25	125 G	2.5 k	2.5 G	50	125 G	2.5 k	625 M	12.5	125 G	2.5 k	1.25 G	25	125 G	2.5 k
1 ns	1.25 G	12.5	125 G	1.25 k	2.5 G	25	125 G	1.25 k	625 M	6.25	125 G	1.25 k	1.25 G	12.5	125 G	1.25 k

Values outside of the thick borders have been calculated in real-time sampling mode.

 : Roll Mode

## When the Record Length Is 125 k points

(This record length can be selected on all models)

IntP: Interpolation Mode  
Rep: Repetitive Sampling Mode

Settings Time/div	When High Resolution mode is off								When High Resolution mode is on							
	When Interleave mode is off				When Interleave mode is on				When Interleave mode is off				When Interleave mode is on			
	Realtime		IntP/Rep		Realtime		IntP/Rep		Realtime		IntP/Rep		Realtime		IntP/Rep	
	Sample Rate (S/s)	Record Length (Points)	Sample Rate (S/s)	Record Length (Points)	Sample Rate (S/s)	Record Length (Points)	Sample Rate (S/s)	Record Length (Points)	Sample Rate (S/s)	Record Length (Points)	Sample Rate (S/s)	Record Length (Points)	Sample Rate (S/s)	Record Length (Points)	Sample Rate (S/s)	Record Length (Points)
500 s	50	250 k	50	250 k	50	250 k	50	250 k	50	250 k	50	250 k	50	250 k	50	250 k
200 s	62.5	125 k	62.5	125 k	62.5	125 k	62.5	125 k	62.5	125 k	62.5	125 k	62.5	125 k	62.5	125 k
100 s	125	125 k	125	125 k	125	125 k	125	125 k	125	125 k	125	125 k	125	125 k	125	125 k
50 s	250	125 k	250	125 k	250	125 k	250	125 k	250	125 k	250	125 k	250	125 k	250	125 k
20 s	625	125 k	625	125 k	625	125 k	625	125 k	625	125 k	625	125 k	625	125 k	625	125 k
10 s	1.25 k	125 k	1.25 k	125 k	1.25 k	125 k	1.25 k	125 k	1.25 k	125 k	1.25 k	125 k	1.25 k	125 k	1.25 k	125 k
5 s	2.5 k	125 k	2.5 k	125 k	2.5 k	125 k	2.5 k	125 k	2.5 k	125 k	2.5 k	125 k	2.5 k	125 k	2.5 k	125 k
2 s	6.25 k	125 k	6.25 k	125 k	6.25 k	125 k	6.25 k	125 k	6.25 k	125 k	6.25 k	125 k	6.25 k	125 k	6.25 k	125 k
1 s	12.5 k	125 k	12.5 k	125 k	12.5 k	125 k	12.5 k	125 k	12.5 k	125 k	12.5 k	125 k	12.5 k	125 k	12.5 k	125 k
500 ms	25 k	125 k	25 k	125 k	25 k	125 k	25 k	125 k	25 k	125 k	25 k	125 k	25 k	125 k	25 k	125 k
200 ms	62.5 k	125 k	62.5 k	125 k	62.5 k	125 k	62.5 k	125 k	62.5 k	125 k	62.5 k	125 k	62.5 k	125 k	62.5 k	125 k
100 ms	125 k	125 k	125 k	125 k	125 k	125 k	125 k	125 k	125 k	125 k	125 k	125 k	125 k	125 k	125 k	125 k
50 ms	250 k	125 k	250 k	125 k	250 k	125 k	250 k	125 k	250 k	125 k	250 k	125 k	250 k	125 k	250 k	125 k
20 ms	625 k	125 k	625 k	125 k	625 k	125 k	625 k	125 k	625 k	125 k	625 k	125 k	625 k	125 k	625 k	125 k
10 ms	1.25 M	125 k	1.25 M	125 k	1.25 M	125 k	1.25 M	125 k	1.25 M	125 k	1.25 M	125 k	1.25 M	125 k	1.25 M	125 k
5 ms	2.5 M	125 k	2.5 M	125 k	2.5 M	125 k	2.5 M	125 k	2.5 M	125 k	2.5 M	125 k	2.5 M	125 k	2.5 M	125 k
2 ms	6.25 M	125 k	6.25 M	125 k	6.25 M	125 k	6.25 M	125 k	6.25 M	125 k	6.25 M	125 k	6.25 M	125 k	6.25 M	125 k
1 ms	12.5 M	125 k	12.5 M	125 k	12.5 M	125 k	12.5 M	125 k	12.5 M	125 k	12.5 M	125 k	12.5 M	125 k	12.5 M	125 k
500 μs	25 M	125 k	25 M	125 k	25 M	125 k	25 M	125 k	25 M	125 k	25 M	125 k	25 M	125 k	25 M	125 k
200 μs	62.5 M	125 k	62.5 M	125 k	62.5 M	125 k	62.5 M	125 k	62.5 M	125 k	62.5 M	125 k	62.5 M	125 k	62.5 M	125 k
100 μs	125 M	125 k	125 M	125 k	125 M	125 k	125 M	125 k	125 M	125 k	125 M	125 k	125 M	125 k	125 M	125 k
50 μs	250 M	125 k	250 M	125 k	250 M	125 k	250 M	125 k	250 M	125 k	250 M	125 k	250 M	125 k	250 M	125 k
20 μs	625 M	125 k	625 M	125 k	625 M	125 k	625 M	125 k	625 M	125 k	625 M	125 k	625 M	125 k	625 M	125 k
10 μs	1.25 G	125 k	1.25 G	125 k	1.25 G	125 k	1.25 G	125 k	625 M	62.5 k	1.25 G	125 k	1.25 G	125 k	1.25 G	125 k
5 μs	1.25 G	62.5 k	2.5 G	125 k	2.5 G	125 k	2.5 G	125 k	625 M	31.25 k	2.5 G	125 k	1.25 G	62.5 k	2.5 G	125 k
2 μs	1.25 G	25 k	6.25 G	125 k	2.5 G	50 k	6.25 G	125 k	625 M	12.5 k	6.25 G	125 k	1.25 G	25 k	6.25 G	125 k
1 μs	1.25 G	12.5 k	12.5 G	125 k	2.5 G	25 k	12.5 G	125 k	625 M	6.25 k	12.5 G	125 k	1.25 G	12.5 k	12.5 G	125 k
500 ns	1.25 G	6.25 k	25 G	125 k	2.5 G	12.5 k	25 G	125 k	625 M	3.125 k	25 G	125 k	1.25 G	6.25 k	25 G	125 k
200 ns	1.25 G	2.5 k	62.5 G	125 k	2.5 G	5 k	62.5 G	125 k	625 M	1.25 k	62.5 G	125 k	1.25 G	2.5 k	62.5 G	125 k
100 ns	1.25 G	1.25 k	125 G	125 k	2.5 G	2.5 k	125 G	125 k	625 M	625	125 G	125 k	1.25 G	1.25 k	125 G	125 k
50 ns	1.25 G	625	125 G	62.5 k	2.5 G	1.25 k	125 G	62.5 k	625 M	312.5	125 G	62.5 k	1.25 G	625	125 G	62.5 k
20 ns	1.25 G	250	125 G	25 k	2.5 G	500	125 G	25 k	625 M	125	125 G	25 k	1.25 G	250	125 G	25 k
10 ns	1.25 G	125	125 G	12.5 k	2.5 G	250	125 G	12.5 k	625 M	62.5	125 G	12.5 k	1.25 G	125	125 G	12.5 k
5 ns	1.25 G	62.5	125 G	6.25 k	2.5 G	125	125 G	6.25 k	625 M	31.25	125 G	6.25 k	1.25 G	62.5	125 G	6.25 k
2 ns	1.25 G	25	125 G	2.5 k	2.5 G	50	125 G	2.5 k	625 M	12.5	125 G	2.5 k	1.25 G	25	125 G	2.5 k
1 ns	1.25 G	12.5	125 G	1.25 k	2.5 G	25	125 G	1.25 k	625 M	6.25	125 G	1.25 k	1.25 G	12.5	125 G	1.25 k

Values outside of the thick borders have been calculated in real-time sampling mode.

 : Roll Mode

**Appendix 1 Relationship between the Time Axis Setting, Record Length, and Sample Rate**

**When the Record Length Is 1.25 M points**

(This record length can be selected on all models)

IntP: Interpolation Mode  
Rep: Repetitive Sampling Mode

Settings Time/div	When High Resolution mode is off								When High Resolution mode is on							
	When Interleave mode is off				When Interleave mode is on				When Interleave mode is off				When Interleave mode is on			
	Realtime		IntP/Rep		Realtime		IntP/Rep		Realtime		IntP/Rep		Realtime		IntP/Rep	
	Sample Rate (S/s)	Record Length (Points)	Sample Rate (S/s)	Record Length (Points)	Sample Rate (S/s)	Record Length (Points)	Sample Rate (S/s)	Record Length (Points)	Sample Rate (S/s)	Record Length (Points)	Sample Rate (S/s)	Record Length (Points)	Sample Rate (S/s)	Record Length (Points)	Sample Rate (S/s)	Record Length (Points)
500 s	250	1.25 M	250	1.25 M	250	1.25 M	250	1.25 M	250	1.25 M	250	1.25 M	250	1.25 M	250	1.25 M
200 s	625	1.25 M	625	1.25 M	625	1.25 M	625	1.25 M	625	1.25 M	625	1.25 M	625	1.25 M	625	1.25 M
100 s	1.25 k	1.25 M	1.25 k	1.25 M	1.25 k	1.25 M	1.25 k	1.25 M	1.25 k	1.25 M	1.25 k	1.25 M	1.25 k	1.25 M	1.25 k	1.25 M
50 s	2.5 k	1.25 M	2.5 k	1.25 M	2.5 k	1.25 M	2.5 k	1.25 M	2.5 k	1.25 M	2.5 k	1.25 M	2.5 k	1.25 M	2.5 k	1.25 M
20 s	6.25 k	1.25 M	6.25 k	1.25 M	6.25 k	1.25 M	6.25 k	1.25 M	6.25 k	1.25 M	6.25 k	1.25 M	6.25 k	1.25 M	6.25 k	1.25 M
10 s	12.5 k	1.25 M	12.5 k	1.25 M	12.5 k	1.25 M	12.5 k	1.25 M	12.5 k	1.25 M	12.5 k	1.25 M	12.5 k	1.25 M	12.5 k	1.25 M
5 s	25 k	1.25 M	25 k	1.25 M	25 k	1.25 M	25 k	1.25 M	25 k	1.25 M	25 k	1.25 M	25 k	1.25 M	25 k	1.25 M
2 s	62.5 k	1.25 M	62.5 k	1.25 M	62.5 k	1.25 M	62.5 k	1.25 M	62.5 k	1.25 M	62.5 k	1.25 M	62.5 k	1.25 M	62.5 k	1.25 M
1 s	125 k	1.25 M	125 k	1.25 M	125 k	1.25 M	125 k	1.25 M	125 k	1.25 M	125 k	1.25 M	125 k	1.25 M	125 k	1.25 M
500 ms	250 k	1.25 M	250 k	1.25 M	250 k	1.25 M	250 k	1.25 M	250 k	1.25 M	250 k	1.25 M	250 k	1.25 M	250 k	1.25 M
200 ms	625 k	1.25 M	625 k	1.25 M	625 k	1.25 M	625 k	1.25 M	625 k	1.25 M	625 k	1.25 M	625 k	1.25 M	625 k	1.25 M
100 ms	1.25 M	1.25 M	1.25 M	1.25 M	1.25 M	1.25 M	1.25 M	1.25 M	1.25 M	1.25 M	1.25 M	1.25 M	1.25 M	1.25 M	1.25 M	1.25 M
50 ms	2.5 M	1.25 M	2.5 M	1.25 M	2.5 M	1.25 M	2.5 M	1.25 M	2.5 M	1.25 M	2.5 M	1.25 M	2.5 M	1.25 M	2.5 M	1.25 M
20 ms	6.25 M	1.25 M	6.25 M	1.25 M	6.25 M	1.25 M	6.25 M	1.25 M	6.25 M	1.25 M	6.25 M	1.25 M	6.25 M	1.25 M	6.25 M	1.25 M
10 ms	12.5 M	1.25 M	12.5 M	1.25 M	12.5 M	1.25 M	12.5 M	1.25 M	12.5 M	1.25 M	12.5 M	1.25 M	12.5 M	1.25 M	12.5 M	1.25 M
5 ms	25 M	1.25 M	25 M	1.25 M	25 M	1.25 M	25 M	1.25 M	25 M	1.25 M	25 M	1.25 M	25 M	1.25 M	25 M	1.25 M
2 ms	62.5 M	1.25 M	62.5 M	1.25 M	62.5 M	1.25 M	62.5 M	1.25 M	62.5 M	1.25 M	62.5 M	1.25 M	62.5 M	1.25 M	62.5 M	1.25 M
1 ms	125 M	1.25 M	125 M	1.25 M	125 M	1.25 M	125 M	1.25 M	125 M	1.25 M	125 M	1.25 M	125 M	1.25 M	125 M	1.25 M
500 μs	250 M	1.25 M	250 M	1.25 M	250 M	1.25 M	250 M	1.25 M	250 M	1.25 M	250 M	1.25 M	250 M	1.25 M	250 M	1.25 M
200 μs	625 M	1.25 M	625 M	1.25 M	625 M	1.25 M	625 M	1.25 M	625 M	1.25 M	625 M	1.25 M	625 M	1.25 M	625 M	1.25 M
100 μs	1.25 G	1.25 M	1.25 G	1.25 M	1.25 G	1.25 M	1.25 G	1.25 M	625 M	625 k	1.25 G	1.25 M	1.25 G	1.25 M	1.25 G	1.25 M
50 μs	1.25 G	625 k	2.5 G	1.25 M	2.5 G	1.25 M	2.5 G	1.25 M	625 M	312.5 k	2.5 G	1.25 M	1.25 G	625 k	2.5 G	1.25 M
20 μs	1.25 G	250 k	6.25 G	1.25 M	2.5 G	500 k	6.25 G	1.25 M	625 M	125 k	6.25 G	1.25 M	1.25 G	250 k	6.25 G	1.25 M
10 μs	1.25 G	125 k	12.5 G	1.25 M	2.5 G	250 k	12.5 G	1.25 M	625 M	62.5 k	12.5 G	1.25 M	1.25 G	125 k	12.5 G	1.25 M
5 μs	1.25 G	62.5 k	25 G	1.25 M	2.5 G	125 k	25 G	1.25 M	625 M	31.25 k	25 G	1.25 M	1.25 G	62.5 k	25 G	1.25 M
2 μs	1.25 G	25 k	62.5 G	1.25 M	2.5 G	50 k	62.5 G	1.25 M	625 M	12.5 k	62.5 G	1.25 M	1.25 G	25 k	62.5 G	1.25 M
1 μs	1.25 G	12.5 k	125 G	1.25 M	2.5 G	25 k	125 G	1.25 M	625 M	6.25 k	125 G	1.25 M	1.25 G	12.5 k	125 G	1.25 M
500 ns	1.25 G	6.25 k	125 G	625 k	2.5 G	12.5 k	125 G	625 k	625 M	3.125 k	125 G	625 k	1.25 G	6.25 k	125 G	625 k
200 ns	1.25 G	2.5 k	125 G	250 k	2.5 G	5 k	125 G	250 k	625 M	1.25 k	125 G	250 k	1.25 G	2.5 k	125 G	250 k
100 ns	1.25 G	1.25 k	125 G	125 k	2.5 G	2.5 k	125 G	125 k	625 M	625	125 G	125 k	1.25 G	1.25 k	125 G	125 k
50 ns	1.25 G	625	125 G	62.5 k	2.5 G	1.25 k	125 G	62.5 k	625 M	312.5	125 G	62.5 k	1.25 G	625	125 G	62.5 k
20 ns	1.25 G	250	125 G	25 k	2.5 G	500	125 G	25 k	625 M	125	125 G	25 k	1.25 G	250	125 G	25 k
10 ns	1.25 G	125	125 G	12.5 k	2.5 G	250	125 G	12.5 k	625 M	62.5	125 G	12.5 k	1.25 G	125	125 G	12.5 k
5 ns	1.25 G	62.5	125 G	6.25 k	2.5 G	125	125 G	6.25 k	625 M	31.25	125 G	6.25 k	1.25 G	62.5	125 G	6.25 k
2 ns	1.25 G	25	125 G	2.5 k	2.5 G	50	125 G	2.5 k	625 M	12.5	125 G	2.5 k	1.25 G	25	125 G	2.5 k
1 ns	1.25 G	12.5	125 G	1.25 k	2.5 G	25	125 G	1.25 k	625 M	6.25	125 G	1.25 k	1.25 G	12.5	125 G	1.25 k

Values outside of the thick borders have been calculated in real-time sampling mode.

 : Roll Mode

## When the Record Length Is 6.25 M points

(This record length can be selected when there is no memory option or on DLM4000s with the /M1 or /M3 option)

IntP: Interpolation Mode  
Rep: Repetitive Sampling Mode

Settings Time/div	When High Resolution mode is off								When High Resolution mode is on <sup>1</sup>							
	When Interleave mode is off				When Interleave mode is on				When Interleave mode is off				When Interleave mode is on			
	Realtime		IntP/Rep <sup>2</sup>		Realtime		IntP/Rep <sup>2</sup>		Realtime		IntP/Rep		Realtime		IntP/Rep	
	Sample Rate (S/s)	Record Length (Points)	Sample Rate (S/s)	Record Length (Points)	Sample Rate (S/s)	Record Length (Points)	Sample Rate (S/s)	Record Length (Points)	Sample Rate (S/s)	Record Length (Points)	Sample Rate (S/s)	Record Length (Points)	Sample Rate (S/s)	Record Length (Points)	Sample Rate (S/s)	Record Length (Points)
500 s	1.25 k	6.25 M	1.25 k	6.25 M	1.25 k	6.25 M	1.25 k	6.25 M	1.25 k	6.25 M	1.25 k	6.25 M	1.25 k	6.25 M	1.25 k	6.25 M
200 s	3.125 k	6.25 M	3.125 k	6.25 M	3.125 k	6.25 M	3.125 k	6.25 M	3.125 k	6.25 M	3.125 k	6.25 M	3.125 k	6.25 M	3.125 k	6.25 M
100 s	6.25 k	6.25 M	6.25 k	6.25 M	6.25 k	6.25 M	6.25 k	6.25 M	6.25 k	6.25 M	6.25 k	6.25 M	6.25 k	6.25 M	6.25 k	6.25 M
50 s	12.5 k	6.25 M	12.5 k	6.25 M	12.5 k	6.25 M	12.5 k	6.25 M	12.5 k	6.25 M	12.5 k	6.25 M	12.5 k	6.25 M	12.5 k	6.25 M
20 s	31.25 k	6.25 M	31.25 k	6.25 M	31.25 k	6.25 M	31.25 k	6.25 M	31.25 k	6.25 M	31.25 k	6.25 M	31.25 k	6.25 M	31.25 k	6.25 M
10 s	62.5 k	6.25 M	62.5 k	6.25 M	62.5 k	6.25 M	62.5 k	6.25 M	62.5 k	6.25 M	62.5 k	6.25 M	62.5 k	6.25 M	62.5 k	6.25 M
5 s	125 k	6.25 M	125 k	6.25 M	125 k	6.25 M	125 k	6.25 M	125 k	6.25 M	125 k	6.25 M	125 k	6.25 M	125 k	6.25 M
2 s	312.5 k	6.25 M	312.5 k	6.25 M	312.5 k	6.25 M	312.5 k	6.25 M	312.5 k	6.25 M	312.5 k	6.25 M	312.5 k	6.25 M	312.5 k	6.25 M
1 s	625 k	6.25 M	625 k	6.25 M	625 k	6.25 M	625 k	6.25 M	625 k	6.25 M	625 k	6.25 M	625 k	6.25 M	625 k	6.25 M
500 ms	1.25 M	6.25 M	1.25 M	6.25 M	1.25 M	6.25 M	1.25 M	6.25 M	1.25 M	6.25 M	1.25 M	6.25 M	1.25 M	6.25 M	1.25 M	6.25 M
200 ms	3.125 M	6.25 M	3.125 M	6.25 M	3.125 M	6.25 M	3.125 M	6.25 M	3.125 M	6.25 M	3.125 M	6.25 M	3.125 M	6.25 M	3.125 M	6.25 M
100 ms	6.25 M	6.25 M	6.25 M	6.25 M	6.25 M	6.25 M	6.25 M	6.25 M	6.25 M	6.25 M	6.25 M	6.25 M	6.25 M	6.25 M	6.25 M	6.25 M
50 ms	12.5 M	6.25 M	12.5 M	6.25 M	12.5 M	6.25 M	12.5 M	6.25 M	12.5 M	6.25 M	12.5 M	6.25 M	12.5 M	6.25 M	12.5 M	6.25 M
20 ms	31.25 M	6.25 M	31.25 M	6.25 M	31.25 M	6.25 M	31.25 M	6.25 M	31.25 M	6.25 M	31.25 M	6.25 M	31.25 M	6.25 M	31.25 M	6.25 M
10 ms	62.5 M	6.25 M	62.5 M	6.25 M	62.5 M	6.25 M	62.5 M	6.25 M	62.5 M	6.25 M	62.5 M	6.25 M	62.5 M	6.25 M	62.5 M	6.25 M
5 ms	125 M	6.25 M	125 M	6.25 M	125 M	6.25 M	125 M	6.25 M	125 M	6.25 M	125 M	6.25 M	125 M	6.25 M	125 M	6.25 M
2 ms	312.5 M	6.25 M	312.5 M	6.25 M	312.5 M	6.25 M	312.5 M	6.25 M	312.5 M	6.25 M	312.5 M	6.25 M	312.5 M	6.25 M	312.5 M	6.25 M
1 ms	625 M	6.25 M	625 M	6.25 M	625 M	6.25 M	625 M	6.25 M	625 M	6.25 M	625 M	6.25 M	625 M	6.25 M	625 M	6.25 M
500 μs	1.25 G	6.25 M	1.25 G	6.25 M	1.25 G	6.25 M	1.25 G	6.25 M	625 M	3.125 M	1.25 G	6.25 M	1.25 G	6.25 M	1.25 G	6.25 M
200 μs	1.25 G	2.5 M	3.125 G	6.25 M	2.5 G	5 M	3.125 G	6.25 M	625 M	1.25 M	3.125 G	6.25 M	1.25 G	2.5 M	3.125 G	6.25 M
100 μs	1.25 G	1.25 M	6.25 G	6.25 M	2.5 G	2.5 M	6.25 G	6.25 M	625 M	625 k	6.25 G	6.25 M	1.25 G	1.25 M	6.25 G	6.25 M
50 μs	1.25 G	625 k	12.5 G	6.25 M	2.5 G	1.25 M	12.5 G	6.25 M	625 M	312.5 k	12.5 G	6.25 M	1.25 G	625 k	12.5 G	6.25 M
20 μs	1.25 G	250 k	31.25 G	6.25 M	2.5 G	500 k	31.25 G	6.25 M	625 M	125 k	31.25 G	6.25 M	1.25 G	250 k	31.25 G	6.25 M
10 μs	1.25 G	125 k	62.5 G	6.25 M	2.5 G	250 k	62.5 G	6.25 M	625 M	62.5 k	62.5 G	6.25 M	1.25 G	125 k	62.5 G	6.25 M
5 μs	1.25 G	62.5 k	125 G	6.25 M	2.5 G	125 k	125 G	6.25 M	625 M	31.25 k	125 G	6.25 M	1.25 G	62.5 k	125 G	6.25 M
2 μs	1.25 G	25 k	125 G	2.5 M	2.5 G	50 k	125 G	2.5 M	625 M	12.5 k	125 G	2.5 M	1.25 G	25 k	125 G	2.5 M
1 μs	1.25 G	12.5 k	125 G	1.25 M	2.5 G	25 k	125 G	1.25 M	625 M	6.25 k	125 G	1.25 M	1.25 G	12.5 k	125 G	1.25 M
500 ns	1.25 G	6.25 k	125 G	625 k	2.5 G	12.5 k	125 G	625 k	625 M	3.125 k	125 G	625 k	1.25 G	6.25 k	125 G	625 k
200 ns	1.25 G	2.5 k	125 G	250 k	2.5 G	5 k	125 G	250 k	625 M	1.25 k	125 G	250 k	1.25 G	2.5 k	125 G	250 k
100 ns	1.25 G	1.25 k	125 G	125 k	2.5 G	2.5 k	125 G	125 k	625 M	625	125 G	125 k	1.25 G	1.25 k	125 G	125 k
50 ns	1.25 G	625	125 G	62.5 k	2.5 G	1.25 k	125 G	62.5 k	625 M	312.5	125 G	62.5 k	1.25 G	625	125 G	62.5 k
20 ns	1.25 G	250	125 G	25 k	2.5 G	500	125 G	25 k	625 M	125	125 G	25 k	1.25 G	250	125 G	25 k
10 ns	1.25 G	125	125 G	12.5 k	2.5 G	250	125 G	12.5 k	625 M	62.5	125 G	12.5 k	1.25 G	125	125 G	12.5 k
5 ns	1.25 G	62.5	125 G	6.25 k	2.5 G	125	125 G	6.25 k	625 M	31.25	125 G	6.25 k	1.25 G	62.5	125 G	6.25 k
2 ns	1.25 G	25	125 G	2.5 k	2.5 G	50	125 G	2.5 k	625 M	12.5	125 G	2.5 k	1.25 G	25	125 G	2.5 k
1 ns	1.25 G	12.5	125 G	1.25 k	2.5 G	25	125 G	1.25 k	625 M	6.25	125 G	1.25 k	1.25 G	12.5	125 G	1.25 k

Values outside of the thick borders have been calculated in real-time sampling mode.

If there is no memory option, acquisition with this record length is performed in single mode.

- 1 If there is no memory option, high resolution mode cannot be used with this record length.
- 2 If there is no memory option, interpolation mode and repetitive sampling mode cannot be used with this record length.

 : Roll Mode

## When the Record Length Is 12.5 M points

(This record length can be selected when there is no memory option or on DLM4000s with the /M2 or /M3 option)

IntP: Interpolation Mode  
Rep: Repetitive Sampling Mode

Settings Time/div	When High Resolution mode is off								When High Resolution mode is on <sup>1</sup>							
	When Interleave mode is off <sup>2</sup>				When Interleave mode is on				When Interleave mode is off				When Interleave mode is on			
	Realtime		IntP/Rep		Realtime		IntP/Rep <sup>3</sup>		Realtime		IntP/Rep		Realtime		IntP/Rep	
	Sample Rate (S/s)	Record Length (Points)	Sample Rate (S/s)	Record Length (Points)	Sample Rate (S/s)	Record Length (Points)	Sample Rate (S/s)	Record Length (Points)	Sample Rate (S/s)	Record Length (Points)	Sample Rate (S/s)	Record Length (Points)	Sample Rate (S/s)	Record Length (Points)	Sample Rate (S/s)	Record Length (Points)
500 s	2.5 k	12.5 M	2.5 k	12.5 M	2.5 k	12.5 M	2.5 k	12.5 M	2.5 k	12.5 M	2.5 k	12.5 M	2.5 k	12.5 M	2.5 k	12.5 M
200 s	6.25 k	12.5 M	6.25 k	12.5 M	6.25 k	12.5 M	6.25 k	12.5 M	6.25 k	12.5 M	6.25 k	12.5 M	6.25 k	12.5 M	6.25 k	12.5 M
100 s	12.5 k	12.5 M	12.5 k	12.5 M	12.5 k	12.5 M	12.5 k	12.5 M	12.5 k	12.5 M	12.5 k	12.5 M	12.5 k	12.5 M	12.5 k	12.5 M
50 s	25 k	12.5 M	25 k	12.5 M	25 k	12.5 M	25 k	12.5 M	25 k	12.5 M	25 k	12.5 M	25 k	12.5 M	25 k	12.5 M
20 s	62.5 k	12.5 M	62.5 k	12.5 M	62.5 k	12.5 M	62.5 k	12.5 M	62.5 k	12.5 M	62.5 k	12.5 M	62.5 k	12.5 M	62.5 k	12.5 M
10 s	125 k	12.5 M	125 k	12.5 M	125 k	12.5 M	125 k	12.5 M	125 k	12.5 M	125 k	12.5 M	125 k	12.5 M	125 k	12.5 M
5 s	250 k	12.5 M	250 k	12.5 M	250 k	12.5 M	250 k	12.5 M	250 k	12.5 M	250 k	12.5 M	250 k	12.5 M	250 k	12.5 M
2 s	625 k	12.5 M	625 k	12.5 M	625 k	12.5 M	625 k	12.5 M	625 k	12.5 M	625 k	12.5 M	625 k	12.5 M	625 k	12.5 M
1 s	1.25 M	12.5 M	1.25 M	12.5 M	1.25 M	12.5 M	1.25 M	12.5 M	1.25 M	12.5 M	1.25 M	12.5 M	1.25 M	12.5 M	1.25 M	12.5 M
500 ms	2.5 M	12.5 M	2.5 M	12.5 M	2.5 M	12.5 M	2.5 M	12.5 M	2.5 M	12.5 M	2.5 M	12.5 M	2.5 M	12.5 M	2.5 M	12.5 M
200 ms	6.25 M	12.5 M	6.25 M	12.5 M	6.25 M	12.5 M	6.25 M	12.5 M	6.25 M	12.5 M	6.25 M	12.5 M	6.25 M	12.5 M	6.25 M	12.5 M
100 ms	12.5 M	12.5 M	12.5 M	12.5 M	12.5 M	12.5 M	12.5 M	12.5 M	12.5 M	12.5 M	12.5 M	12.5 M	12.5 M	12.5 M	12.5 M	12.5 M
50 ms	25 M	12.5 M	25 M	12.5 M	25 M	12.5 M	25 M	12.5 M	25 M	12.5 M	25 M	12.5 M	25 M	12.5 M	25 M	12.5 M
20 ms	62.5 M	12.5 M	62.5 M	12.5 M	62.5 M	12.5 M	62.5 M	12.5 M	62.5 M	12.5 M	62.5 M	12.5 M	62.5 M	12.5 M	62.5 M	12.5 M
10 ms	125 M	12.5 M	125 M	12.5 M	125 M	12.5 M	125 M	12.5 M	125 M	12.5 M	125 M	12.5 M	125 M	12.5 M	125 M	12.5 M
5 ms	250 M	12.5 M	250 M	12.5 M	250 M	12.5 M	250 M	12.5 M	250 M	12.5 M	250 M	12.5 M	250 M	12.5 M	250 M	12.5 M
2 ms	625 M	12.5 M	625 M	12.5 M	625 M	12.5 M	625 M	12.5 M	625 M	12.5 M	625 M	12.5 M	625 M	12.5 M	625 M	12.5 M
1 ms	1.25 G	12.5 M	1.25 G	12.5 M	1.25 G	12.5 M	1.25 G	12.5 M	625 M	6.25 M	1.25 G	12.5 M	1.25 G	12.5 M	1.25 G	12.5 M
500 µs	1.25 G	6.25 M	2.5 G	12.5 M	2.5 G	12.5 M	2.5 G	12.5 M	625 M	3.125 M	2.5 G	12.5 M	1.25 G	6.25 M	2.5 G	12.5 M
200 µs	1.25 G	2.5 M	6.25 G	12.5 M	2.5 G	5 M	6.25 G	12.5 M	625 M	1.25 M	6.25 G	12.5 M	1.25 G	2.5 M	6.25 G	12.5 M
100 µs	1.25 G	1.25 M	12.5 G	12.5 M	2.5 G	2.5 M	12.5 G	12.5 M	625 M	625 k	12.5 G	12.5 M	1.25 G	1.25 M	12.5 G	12.5 M
50 µs	1.25 G	625 k	25 G	12.5 M	2.5 G	1.25 M	25 G	12.5 M	625 M	312.5 k	25 G	12.5 M	1.25 G	625 k	25 G	12.5 M
20 µs	1.25 G	250 k	62.5 G	12.5 M	2.5 G	500 k	62.5 G	12.5 M	625 M	125 k	62.5 G	12.5 M	1.25 G	250 k	62.5 G	12.5 M
10 µs	1.25 G	125 k	125 G	12.5 M	2.5 G	250 k	125 G	12.5 M	625 M	62.5 k	125 G	12.5 M	1.25 G	125 k	125 G	12.5 M
5 µs	1.25 G	62.5 k	125 G	6.25 M	2.5 G	125 k	125 G	6.25 M	625 M	31.25 k	125 G	6.25 M	1.25 G	62.5 k	125 G	6.25 M
2 µs	1.25 G	25 k	125 G	2.5 M	2.5 G	50 k	125 G	2.5 M	625 M	12.5 k	125 G	2.5 M	1.25 G	25 k	125 G	2.5 M
1 µs	1.25 G	12.5 k	125 G	1.25 M	2.5 G	25 k	125 G	1.25 M	625 M	6.25 k	125 G	1.25 M	1.25 G	12.5 k	125 G	1.25 M
500 ns	1.25 G	6.25 k	125 G	625 k	2.5 G	12.5 k	125 G	625 k	625 M	3.125 k	125 G	625 k	1.25 G	6.25 k	125 G	625 k
200 ns	1.25 G	2.5 k	125 G	250 k	2.5 G	5 k	125 G	250 k	625 M	1.25 k	125 G	250 k	1.25 G	2.5 k	125 G	250 k
100 ns	1.25 G	1.25 k	125 G	125 k	2.5 G	2.5 k	125 G	125 k	625 M	625	125 G	125 k	1.25 G	1.25 k	125 G	125 k
50 ns	1.25 G	625	125 G	62.5 k	2.5 G	1.25 k	125 G	62.5 k	625 M	312.5	125 G	62.5 k	1.25 G	625	125 G	62.5 k
20 ns	1.25 G	250	125 G	25 k	2.5 G	500	125 G	25 k	625 M	125	125 G	25 k	1.25 G	250	125 G	25 k
10 ns	1.25 G	125	125 G	12.5 k	2.5 G	250	125 G	12.5 k	625 M	62.5	125 G	12.5 k	1.25 G	125	125 G	12.5 k
5 ns	1.25 G	62.5	125 G	6.25 k	2.5 G	125	125 G	6.25 k	625 M	31.25	125 G	6.25 k	1.25 G	62.5	125 G	6.25 k
2 ns	1.25 G	25	125 G	2.5 k	2.5 G	50	125 G	2.5 k	625 M	12.5	125 G	2.5 k	1.25 G	25	125 G	2.5 k
1 ns	1.25 G	12.5	125 G	1.25 k	2.5 G	25	125 G	1.25 k	625 M	6.25	125 G	1.25 k	1.25 G	12.5	125 G	1.25 k

Values outside of the thick borders have been calculated in real-time sampling mode.

If there is no memory option, acquisition with this record length is performed in single mode.

- 1 If there is no memory option, high resolution mode cannot be used with this record length.
- 2 If there is no memory option, with this record length, interleave mode cannot be turned off.
- 3 If there is no memory option, interpolation mode and repetitive sampling mode cannot be used with this record length.

  : Roll Mode



## When the Record Length Is 25 M points

(This record length can be selected on DLM4000s with the /M1 or /M3 option)

IntP: Interpolation Mode  
Rep: Repetitive Sampling Mode

Settings Time/div	When High Resolution mode is off								When High Resolution mode is on <sup>1</sup>							
	When Interleave mode is off				When Interleave mode is on				When Interleave mode is off				When Interleave mode is on			
	Realtime		IntP/Rep <sup>2</sup>		Realtime		IntP/Rep <sup>2</sup>		Realtime		IntP/Rep		Realtime		IntP/Rep	
	Sample Rate (S/s)	Record Length (Points)	Sample Rate (S/s)	Record Length (Points)	Sample Rate (S/s)	Record Length (Points)	Sample Rate (S/s)	Record Length (Points)	Sample Rate (S/s)	Record Length (Points)	Sample Rate (S/s)	Record Length (Points)	Sample Rate (S/s)	Record Length (Points)	Sample Rate (S/s)	Record Length (Points)
500 s	5 k	25 M	5 k	25 M	5 k	25 M	5 k	25 M	5 k	25 M	5 k	25 M	5 k	25 M	5 k	25 M
200 s	12.5 k	25 M	12.5 k	25 M	12.5 k	25 M	12.5 k	25 M	12.5 k	25 M	12.5 k	25 M	12.5 k	25 M	12.5 k	25 M
100 s	25 k	25 M	25 k	25 M	25 k	25 M	25 k	25 M	25 k	25 M	25 k	25 M	25 k	25 M	25 k	25 M
50 s	50 k	25 M	50 k	25 M	50 k	25 M	50 k	25 M	50 k	25 M	50 k	25 M	50 k	25 M	50 k	25 M
20 s	125 k	25 M	125 k	25 M	125 k	25 M	125 k	25 M	125 k	25 M	125 k	25 M	125 k	25 M	125 k	25 M
10 s	250 k	25 M	250 k	25 M	250 k	25 M	250 k	25 M	250 k	25 M	250 k	25 M	250 k	25 M	250 k	25 M
5 s	500 k	25 M	500 k	25 M	500 k	25 M	500 k	25 M	500 k	25 M	500 k	25 M	500 k	25 M	500 k	25 M
2 s	1.25 M	25 M	1.25 M	25 M	1.25 M	25 M	1.25 M	25 M	1.25 M	25 M	1.25 M	25 M	1.25 M	25 M	1.25 M	25 M
1 s	2.5 M	25 M	2.5 M	25 M	2.5 M	25 M	2.5 M	25 M	2.5 M	25 M	2.5 M	25 M	2.5 M	25 M	2.5 M	25 M
500 ms	5 M	25 M	5 M	25 M	5 M	25 M	5 M	25 M	5 M	25 M	5 M	25 M	5 M	25 M	5 M	25 M
200 ms	12.5 M	25 M	12.5 M	25 M	12.5 M	25 M	12.5 M	25 M	12.5 M	25 M	12.5 M	25 M	12.5 M	25 M	12.5 M	25 M
100 ms	25 M	25 M	25 M	25 M	25 M	25 M	25 M	25 M	25 M	25 M	25 M	25 M	25 M	25 M	25 M	25 M
50 ms	25 M	12.5 M	25 M	12.5 M	25 M	12.5 M	25 M	12.5 M	25 M	12.5 M	25 M	12.5 M	25 M	12.5 M	25 M	12.5 M
20 ms	125 M	25 M	125 M	25 M	125 M	25 M	125 M	25 M	125 M	25 M	125 M	25 M	125 M	25 M	125 M	25 M
10 ms	250 M	25 M	250 M	25 M	250 M	25 M	250 M	25 M	250 M	25 M	250 M	25 M	250 M	25 M	250 M	25 M
5 ms	250 M	12.5 M	250 M	12.5 M	250 M	12.5 M	250 M	12.5 M	250 M	12.5 M	250 M	12.5 M	250 M	12.5 M	250 M	12.5 M
2 ms	1.25 G	25 M	1.25 G	25 M	1.25 G	25 M	1.25 G	25 M	625 M	12.5 M	1.25 G	25 M	1.25 G	25 M	1.25 G	25 M
1 ms	1.25 G	12.5 M	2.5 G	25 M	2.5 G	25 M	2.5 G	25 M	625 M	6.25 M	2.5 G	25 M	1.25 G	12.5 M	2.5 G	25 M
500 μs	1.25 G	6.25 M	5 G	25 M	2.5 G	12.5 M	5 G	25 M	625 M	3.125 M	5 G	25 M	1.25 G	6.25 M	5 G	25 M
200 μs	1.25 G	2.5 M	12.5 G	25 M	2.5 G	5 M	12.5 G	25 M	625 M	1.25 M	12.5 G	25 M	1.25 G	2.5 M	12.5 G	25 M
100 μs	1.25 G	1.25 M	25 G	25 M	2.5 G	2.5 M	25 G	25 M	625 M	625 k	25 G	25 M	1.25 G	1.25 M	25 G	25 M
50 μs	1.25 G	625 k	50 G	25 M	2.5 G	1.25 M	50 G	25 M	625 M	312.5 k	50 G	25 M	1.25 G	625 k	50 G	25 M
20 μs	1.25 G	250 k	125 G	25 M	2.5 G	500 k	125 G	25 M	625 M	125 k	125 G	25 M	1.25 G	250 k	125 G	25 M
10 μs	1.25 G	125 k	125 G	12.5 M	2.5 G	250 k	125 G	12.5 M	625 M	62.5 k	125 G	12.5 M	1.25 G	125 k	125 G	12.5 M
5 μs	1.25 G	62.5 k	125 G	6.25 M	2.5 G	125 k	125 G	6.25 M	625 M	31.25 k	125 G	6.25 M	1.25 G	62.5 k	125 G	6.25 M
2 μs	1.25 G	25 k	125 G	2.5 M	2.5 G	50 k	125 G	2.5 M	625 M	12.5 k	125 G	2.5 M	1.25 G	25 k	125 G	2.5 M
1 μs	1.25 G	12.5 k	125 G	1.25 M	2.5 G	25 k	125 G	1.25 M	625 M	6.25 k	125 G	1.25 M	1.25 G	12.5 k	125 G	1.25 M
500 ns	1.25 G	6.25 k	125 G	625 k	2.5 G	12.5 k	125 G	625 k	625 M	3.125 k	125 G	625 k	1.25 G	6.25 k	125 G	625 k
200 ns	1.25 G	2.5 k	125 G	250 k	2.5 G	5 k	125 G	250 k	625 M	1.25 k	125 G	250 k	1.25 G	2.5 k	125 G	250 k
100 ns	1.25 G	1.25 k	125 G	125 k	2.5 G	2.5 k	125 G	125 k	625 M	625	125 G	125 k	1.25 G	1.25 k	125 G	125 k
50 ns	1.25 G	625	125 G	62.5 k	2.5 G	1.25 k	125 G	62.5 k	625 M	312.5	125 G	62.5 k	1.25 G	625	125 G	62.5 k
20 ns	1.25 G	250	125 G	25 k	2.5 G	500	125 G	25 k	625 M	125	125 G	25 k	1.25 G	250	125 G	25 k
10 ns	1.25 G	125	125 G	12.5 k	2.5 G	250	125 G	12.5 k	625 M	62.5	125 G	12.5 k	1.25 G	125	125 G	12.5 k
5 ns	1.25 G	62.5	125 G	6.25 k	2.5 G	125	125 G	6.25 k	625 M	31.25	125 G	6.25 k	1.25 G	62.5	125 G	6.25 k
2 ns	1.25 G	25	125 G	2.5 k	2.5 G	50	125 G	2.5 k	625 M	12.5	125 G	2.5 k	1.25 G	25	125 G	2.5 k
1 ns	1.25 G	12.5	125 G	1.25 k	2.5 G	25	125 G	1.25 k	625 M	6.25	125 G	1.25 k	1.25 G	12.5	125 G	1.25 k

Values outside of the thick borders have been calculated in real-time sampling mode.

On DLM4000s with the /M1 option, acquisition with this record length is performed in single mode.

- On DLM4000s with the /M1 option, high resolution mode cannot be used with this record length.
- On DLM4000s with the /M1 option, interpolation mode and repetitive sampling mode cannot be used with this record length.

 : Roll Mode

## When the Record Length Is 62.5 M points

(This record length can be selected on DLM4000s with the /M1, /M2, or /M3 option)

IntP: Interpolation Mode  
Rep: Repetitive Sampling Mode

Settings  Time/div	When High Resolution mode is off								When High Resolution mode is on									
	When Interleave mode is off*				When Interleave mode is on				When Interleave mode is off				When Interleave mode is on					
	Realtime		IntP/Rep		Realtime		IntP/Rep		Realtime		IntP/Rep		Realtime		IntP/Rep			
	Sample Rate (S/s)	Record Length (Points)	Sample Rate (S/s)	Record Length (Points)	Sample Rate (S/s)	Record Length (Points)	Sample Rate (S/s)	Record Length (Points)	Sample Rate (S/s)	Record Length (Points)	Sample Rate (S/s)	Record Length (Points)	Sample Rate (S/s)	Record Length (Points)	Sample Rate (S/s)	Record Length (Points)		
500 s	12.5 k	62.5 M			12.5 k	62.5 M												
200 s	31.25 k	62.5 M			31.25 k	62.5 M												
100 s	62.5 k	62.5 M			62.5 k	62.5 M												
50 s	125 k	62.5 M			125 k	62.5 M												
20 s	312.5 k	62.5 M			312.5 k	62.5 M												
10 s	625 k	62.5 M			625 k	62.5 M												
5 s	1.25 M	62.5 M			1.25 M	62.5 M												
2 s	3.125 M	62.5 M			3.125 M	62.5 M												
1 s	6.25 M	62.5 M			6.25 M	62.5 M												
500 ms	12.5 M	62.5 M			12.5 M	62.5 M												
200 ms	31.25 M	62.5 M			31.25 M	62.5 M												
100 ms	62.5 M	62.5 M			62.5 M	62.5 M												
50 ms	125 M	62.5 M			125 M	62.5 M												
20 ms	312.5 M	62.5 M			312.5 M	62.5 M												
10 ms	625 M	62.5 M			625 M	62.5 M												
5 ms	1.25 G	62.5 M	Interpolation mode and repetitive sampling mode cannot be used when you specify this record length.		1.25 G	62.5 M	Interpolation mode and repetitive sampling mode cannot be used when you specify this record length.											
2 ms	1.25 G	25 M			2.5 G	50 M												
1 ms	1.25 G	12.5 M			2.5 G	25 M												
500 μs	1.25 G	6.25 M			2.5 G	12.5 M												
200 μs	1.25 G	2.5 M			2.5 G	5 M												
100 μs	1.25 G	1.25 M			2.5 G	2.5 M												
50 μs	1.25 G	625 k			2.5 G	1.25 M												
20 μs	1.25 G	250 k			2.5 G	500 k												
10 μs	1.25 G	125 k			2.5 G	250 k												
5 μs	1.25 G	62.5 k			2.5 G	125 k												
2 μs	1.25 G	25 k			2.5 G	50 k												
1 μs	1.25 G	12.5 k			2.5 G	25 k												
500 ns	1.25 G	6.25 k			2.5 G	12.5 k												
200 ns	1.25 G	2.5 k			2.5 G	5 k												
100 ns	1.25 G	1.25 k			2.5 G	2.5 k												
50 ns	1.25 G	625			2.5 G	1.25 k												
20 ns	1.25 G	250		2.5 G	500													
10 ns	1.25 G	125		2.5 G	250													
5 ns	1.25 G	62.5		2.5 G	125													
2 ns	1.25 G	25		2.5 G	50													
1 ns	1.25 G	12.5		2.5 G	25													

Acquisition when you specify this record length is performed in single mode.

\* On DLM4000s with the /M1 option, with this record length, interleave mode cannot be turned off.

: Roll Mode

## When the Record Length Is 125 M points

(This record length can be selected on DLM4000s with the /M2 or /M3 option)

IntP: Interpolation Mode  
Rep: Repetitive Sampling Mode

Settings Time/div	When High Resolution mode is off								When High Resolution mode is on								
	When Interleave mode is off*				When Interleave mode is on				When Interleave mode is off				When Interleave mode is on				
	Realtime		IntP/Rep		Realtime		IntP/Rep		Realtime		IntP/Rep		Realtime		IntP/Rep		
	Sample Rate (S/s)	Record Length (Points)	Sample Rate (S/s)	Record Length (Points)	Sample Rate (S/s)	Record Length (Points)	Sample Rate (S/s)	Record Length (Points)	Sample Rate (S/s)	Record Length (Points)	Sample Rate (S/s)	Record Length (Points)	Sample Rate (S/s)	Record Length (Points)	Sample Rate (S/s)	Record Length (Points)	
500 s	25 k	125 M			25 k	125 M											
200 s	62.5 k	125 M			62.5 k	125 M											
100 s	125 k	125 M			125 k	125 M											
50 s	250 k	125 M			250 k	125 M											
20 s	625 k	125 M			625 k	125 M											
10 s	1.25 M	125 M			1.25 M	125 M											
5 s	2.5 M	125 M			2.5 M	125 M											
2 s	6.25 M	125 M			6.25 M	125 M											
1 s	12.5 M	125 M			12.5 M	125 M											
500 ms	25 M	125 M			25 M	125 M											
200 ms	62.5 M	125 M			62.5 M	125 M											
100 ms	125 M	125 M			125 M	125 M											
50 ms	250 M	125 M			250 M	125 M											
20 ms	625 M	125 M			625 M	125 M											
10 ms	1.25 G	125 M			1.25 G	125 M											
5 ms	1.25 G	62.5 M	Interpolation mode and repetitive sampling mode cannot be used when you specify this record length.		2.5 G	125 M			Interpolation mode and repetitive sampling mode cannot be used when you specify this record length.								
2 ms	1.25 G	25 M			2.5 G	50 M											
1 ms	1.25 G	12.5 M			2.5 G	25 M											
500 μs	1.25 G	6.25 M			2.5 G	12.5 M											
200 μs	1.25 G	2.5 M			2.5 G	5 M											
100 μs	1.25 G	1.25 M			2.5 G	2.5 M											
50 μs	1.25 G	625 k			2.5 G	1.25 M											
20 μs	1.25 G	250 k			2.5 G	500 k											
10 μs	1.25 G	125 k			2.5 G	250 k											
5 μs	1.25 G	62.5 k			2.5 G	125 k											
2 μs	1.25 G	25 k		2.5 G	50 k												
1 μs	1.25 G	12.5 k		2.5 G	25 k												
500 ns	1.25 G	6.25 k		2.5 G	12.5 k												
200 ns	1.25 G	2.5 k		2.5 G	5 k												
100 ns	1.25 G	1.25 k		2.5 G	2.5 k												
50 ns	1.25 G	625		2.5 G	1.25 k												
20 ns	1.25 G	250		2.5 G	500												
10 ns	1.25 G	125		2.5 G	250												
5 ns	1.25 G	62.5		2.5 G	125												
2 ns	1.25 G	25		2.5 G	50												
1 ns	1.25 G	12.5		2.5 G	25												

When you specify this record length, high resolution mode cannot be turned on.

Acquisition when you specify this record length is performed in single mode.

\* On DLM4000s with the /M2 option, with this record length, interleave mode cannot be turned off.

: Roll Mode

## When the Record Length Is 250 M points

(This record length can be selected on DLM4000s with the /M3 option)

IntP: Interpolation Mode  
Rep: Repetitive Sampling Mode

Settings Time/div	When High Resolution mode is off								When High Resolution mode is on							
	When Interleave mode is off				When Interleave mode is on				When Interleave mode is off				When Interleave mode is on			
	Realtime		IntP/Rep		Realtime		IntP/Rep		Realtime		IntP/Rep		Realtime		IntP/Rep	
	Sample Rate (S/s)	Record Length (Points)	Sample Rate (S/s)	Record Length (Points)	Sample Rate (S/s)	Record Length (Points)	Sample Rate (S/s)	Record Length (Points)	Sample Rate (S/s)	Record Length (Points)	Sample Rate (S/s)	Record Length (Points)	Sample Rate (S/s)	Record Length (Points)	Sample Rate (S/s)	Record Length (Points)
500 s					50 k	250 M										
200 s					125 k	250 M										
100 s					250 k	250 M										
50 s					500 k	250 M										
20 s					1.25 M	250 M										
10 s					2.5 M	250 M										
5 s					5 M	250 M										
2 s					12.5 M	250 M										
1 s					25 M	250 M										
500 ms					25 M	125 M										
200 ms					125 M	250 M										
100 ms					250 M	250 M										
50 ms					250 M	125 M										
20 ms					1.25 G	250 M										
10 ms					1.25 G	125 M										
5 ms					2.5 G	125 M										
2 ms					2.5 G	50 M										
1 ms					2.5 G	25 M										
500 μs					2.5 G	12.5 M										
200 μs					2.5 G	5 M										
100 μs					2.5 G	2.5 M										
50 μs					2.5 G	1.25 M										
20 μs					2.5 G	500 k										
10 μs					2.5 G	250 k										
5 μs					2.5 G	125 k										
2 μs					2.5 G	50 k										
1 μs					2.5 G	25 k										
500 ns					2.5 G	12.5 k										
200 ns					2.5 G	5 k										
100 ns					2.5 G	2.5 k										
50 ns					2.5 G	1.25 k										
20 ns					2.5 G	500										
10 ns					2.5 G	250										
5 ns					2.5 G	125										
2 ns					2.5 G	50										
1 ns					2.5 G	25										

When you specify this record length, interleave mode cannot be turned off.

Interpolation mode and repetitive sampling mode cannot be used when you specify this record length.

When you specify this record length, high resolution mode cannot be turned on.

Acquisition when you specify this record length is performed in single mode.

: Roll Mode

## Appendix 2 USB Keyboard Key Assignments

DLM4000	USB Keyboard
ACQUIRE menu	CTRL+A
MATH/REF menu	CTRL+B
Execute PRINT	CTRL+C
DISPLAY menu	CTRL+D
ENHANCED menu	CTRL+E
FILE menu	CTRL+F
ACTION, GO/NO-GO menu	CTRL+G
HISTORY menu	CTRL+H
Execute DEFAULT SETUP	CTRL+I
Execute AUTO SETUP	CTRL+J
ANALYSIS menu	CTRL+K
LOGIC(L) menu	CTRL+L
LOGIC(A B), applicable to models with the /L16 option	CTRL+SHIFT+I
MEASURE menu	CTRL+M
CURSOR menu	CTRL+N
SEARCH menu	CTRL+O
Set the trigger level to 50%	CTRL+P
Execute CLEAR TRACE	CTRL+Q
Execute RESET	CTRL+R
SHIFT on	CTRL+S
TRIGGER MODE menu	CTRL+T
UTILITY menu	CTRL+U
Set VERTICAL POSITION to 0 div	CTRL+V
EDGE menu	CTRL+W
ZOOM2 menu	CTRL+X
B TRIG menu	CTRL+Y
ZOOM1 menu	CTRL+Z
CH1 menu	CTRL+1
CH2 menu	CTRL+2
CH3 menu	CTRL+3
CH4 menu	CTRL+4
CH5 menu	CTRL+5
CH6 menu	CTRL+6
CH7 menu	CTRL+7
CH8 menu	CTRL+8
Execute HELP	CTRL+ /
Execute SET	CTRL+ENTER
Execute ESC	ESC
FFT menu	CTRL+SHIFT+B
PRINT MENU menu	CTRL+SHIFT+C
X-Y menu	CTRL+SHIFT+D
SERIAL BUS menu	CTRL+SHIFT+O
Set HORIZONTAL POSITION to 50%	CTRL+SHIFT+P
CH UTIL menu	CTRL+SHIFT+U
Switch the SCALE knob between FINE mode and 1-2-5 step mode	CTRL+SHIFT+V
Execute FORCE TRIG	CTRL+SHIFT+Y
Switch the ZOOM knob between FINE mode and 1-2-5 step mode	CTRL+SHIFT+Z or CTRL+SHIFT+X
Select soft key 1	F1
Select soft key 2	F2
Select soft key 3	F3
Select soft key 4	F4
Select soft key 5	F5
Select soft key 6	F6
Select soft key 7	F7
DELAY setup	F9
Execute SINGLE	F11
Execute RUN/STOP	F12

## Appendix 2 USB Keyboard Key Assignments

---

<b>DLM4000</b>	<b>USB Keyboard</b>
Execute SNAP SHOT	Pause
Increase the magnification (ZOOM knob)	CTRL+INSERT
Increase the vertical position (◆ POSITION knob)	CTRL+HOME
Increase the trigger position (◀ POSITION ▶ knob)	CTRL+PAGE UP
Decrease the magnification (ZOOM knob)	CTRL+DELETE
Decrease the vertical position (◆ POSITION knob)	CTRL+END
Decrease the trigger position (◀ POSITION ▶ knob)	CTRL+PAGE DOWN
Move ● right	CTRL+RIGHT
Move ● left	CTRL+LEFT
Move ● down	CTRL+DOWN
Move ● up	CTRL+UP
Increase the trigger level	INSERT
Decrease the trigger level	DELETE
Increase the vertical scale (SCALE knob)	HOME
Decrease the vertical scale (SCALE knob)	END
Increase the time axis setting (TIME/DIV knob)	PAGE UP
Decrease the time axis setting (TIME/DIV knob)	PAGE DOWN