



High accuracy and sample rate

DM7560 Digital Multimeter

Precision Making

Bulletin DM7560-01EN

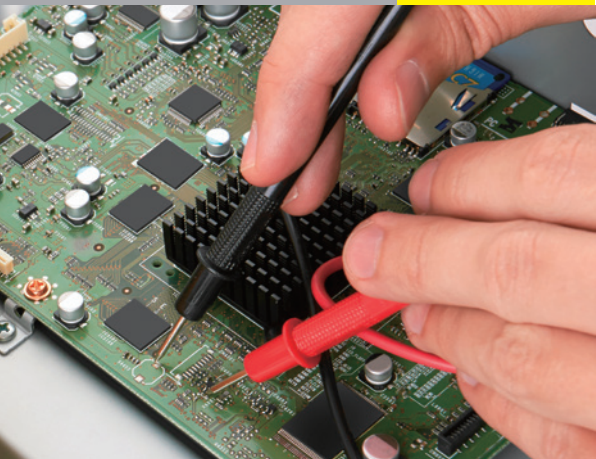

For a long time, a DMM has been a fundamental instrument on an engineer's bench due to its superb versatility for a wide range of electronic applications. As more precise measurement of basic electrical values is required, particularly for new technologies such as fuel and solar cells, DMMs need to have higher performance.

The DM7560 provides high sampling rates of up to 30 kS/s with high accuracy and provides all the basic functions of a Digital Multimeter. With its capability to monitor transitional voltage variations, it can be applied to a wide range of applications.

The DM7560 provides:

Stability – As a $6\frac{1}{2}$ digits bench-top DMM, the DM7560 provides excellent stability and reliability. It keeps its good performance even at high sampling rates.

Visibility – As one of the most advanced bench-top DMMs, The DM7560 provides various display formats. This contributes to intuitive and comprehensive operation in today's demanding measurement scenarios.

Productivity – With a wealth of I/O and communication interfaces, and advanced analysis functions, the DM7560 helps to improve productivity of a wide range of automated testing systems.

Main features

- Full-color, high-resolution display with flexible display formats
- High-speed data logging with up to 30 k points per second
- High-capacity internal memory up to 100 k points
- Trend / histogram analysis available both in real-time and offline
- Multiple PC interface options (USB, Ethernet, GP-IB, RS-232) enable automation

Application examples

- Monitoring battery current consumption
- Sensor testing
- Production testing
- R&D/service
- Voltage reference testing

Front panel

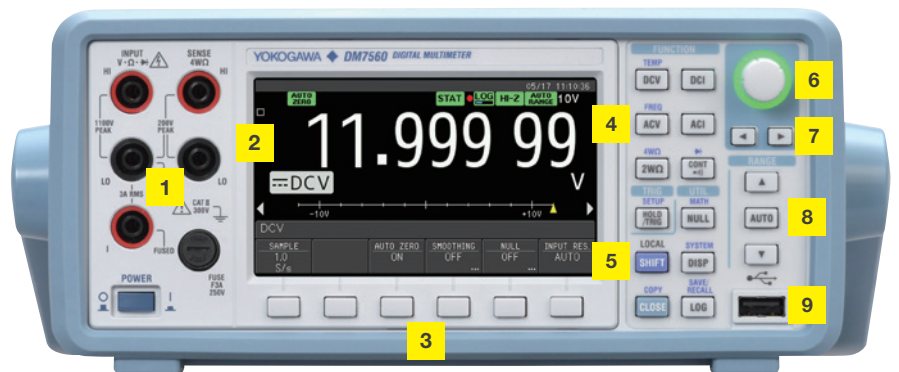

1 Input terminals

2 Display

3 Menu keys

4 Function keys
6 independent keys for each measurement function.

5 TRIG and UTILITY keys

6 Rotary knob
To input numerical values, letters and signs and to select list items. The knob lights up when operable.

7 Arrow keys

Used to move a cursor when inputting and to change display in combination with the SHIFT key.

8 Range switching keys

9 USB memory connection
To connect USB memory and to copy display images, save/recall settings and export data.

Flexible display formats

A large 4.3-inch high-resolution display provides comprehensive data observation using a flexible combination of primary and secondary display areas.

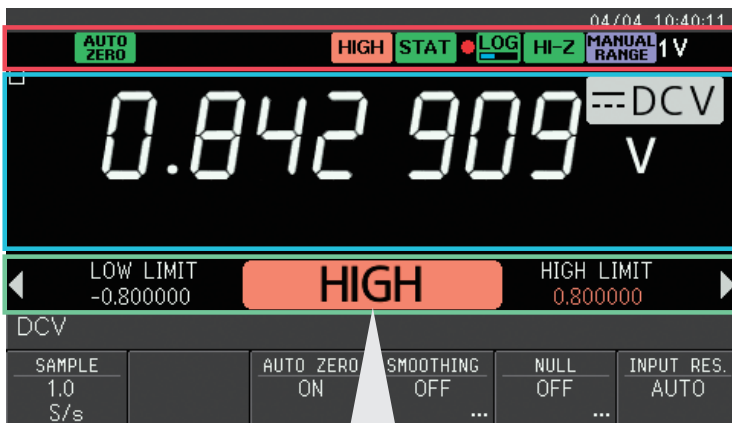

Annunciator

Icons indicate the status of the instrument.

Primary display (examples)

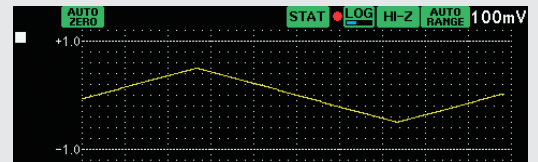

Trend display (show variation in time)

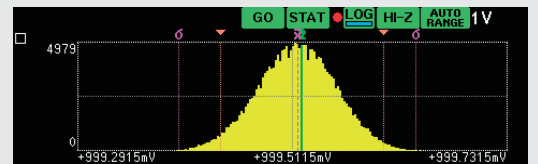

Histogram display (shows variation in distribution)

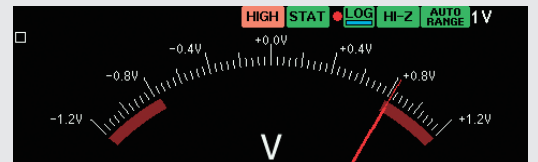

Arc scale meter display (An intuitive indicator)

Secondary display (examples)



Analog meter display

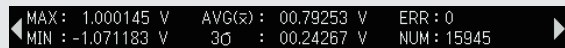

Statistics display



LIMIT judgment display

Display combination examples

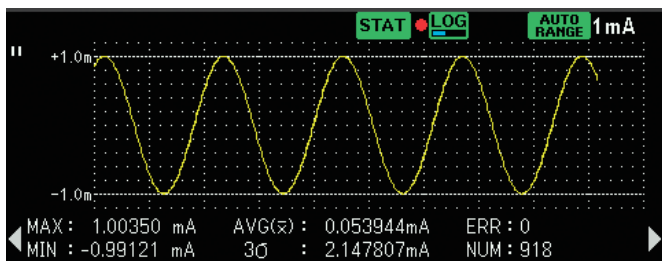

Trend chart + Statistics

The DMM7560 can show different types of visualizations on the display. In this case, the top displays a time-domain trend plot and the lower region displays statistics of this data.



Numerical value + Frequency + Analog meter

Users can display the input signal voltage and frequency side-by-side with numeric values and indicators.

High-speed data logging

Maximum 30 kS/s data logging rate

In bulk mode, data can be logged to the internal memory with high sample rates of up to 30 kS/s. Data logged to the memory can be copied to a USB memory device and analyzed on the PC.

*When DCV, DCI, 2 WΩ, 4 WΩ functions.

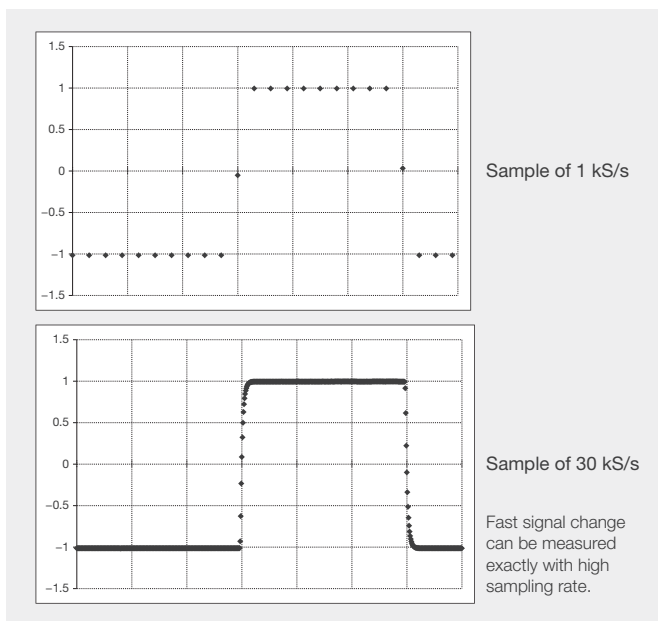

Setting the DM7560 to 30 kS/s enables users to see the details of a 10 ms pulse width on a 2 Vpp measurement.

High-capacity memory

An internal memory of 100 k points enables long-term, high-resolution data logging even for high sample rates. Continuous measurement of over 27 hours is possible with a sample rate of 1 S/s.

Available logging time at each sampling rate

Sampling rate (S/s)	1	1 k	30 k
Logging time (h:m:s)	27:46:40	0:01:40	0:00:03

Triggered data logging

Trigger events such as the measured LEVEL, LIMIT or EXTERNAL TRIGGER can stop logging. Users can specify the amount of data to store after an event occurs.

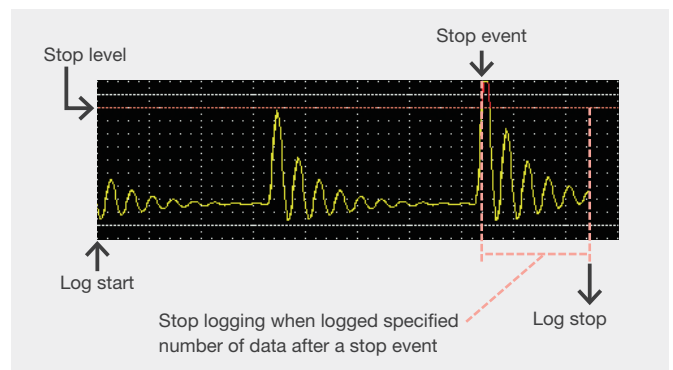

SIGNAL LEVEL events can stop data logging.

PC-based analysis

Users can transfer stored data to a PC file for detailed analysis.

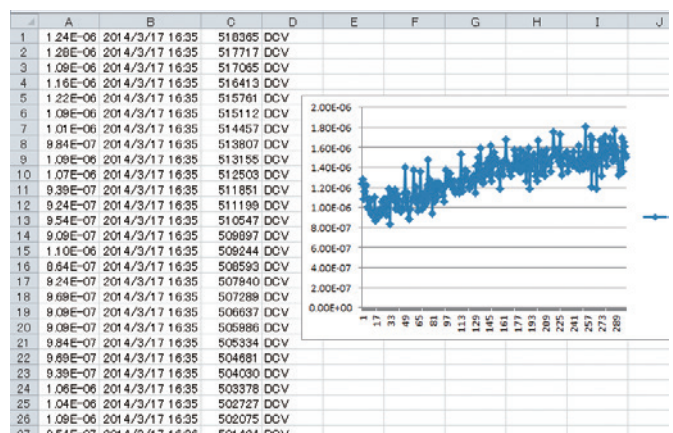

Offline data analysis in the DM7560

DM7560 provides powerful analysis functions for logged data in the internal memory without using a PC.

Yield rate measurement

By setting upper and lower limit values as the cursor position on the histogram display, users can display the number of data, ratio to whole data (%) and yield rate.

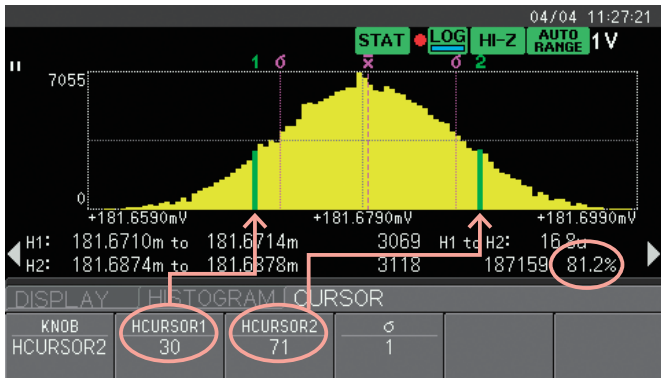

Yield rate and other calculations are available using a cursor controls on the histogram display.

Time trend analysis

In the trend chart, statistic data in a selected time range can be calculated.

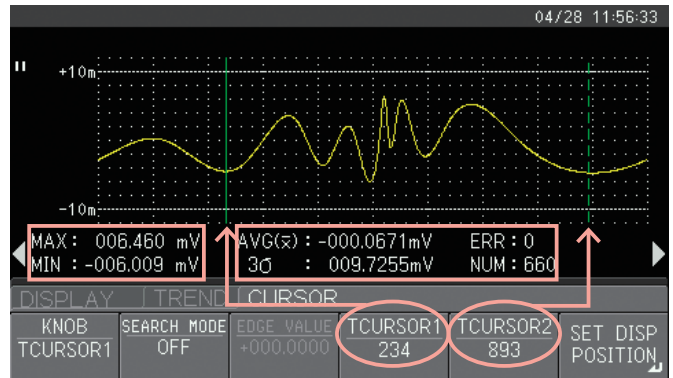

Statistical data such as the MAX/MIN/AVG of a cursor-specified range is calculated automatically.

In-depth analyses

Users can easily zoom to see a magnified part of a trend chart or display the zoomed region as a histogram.

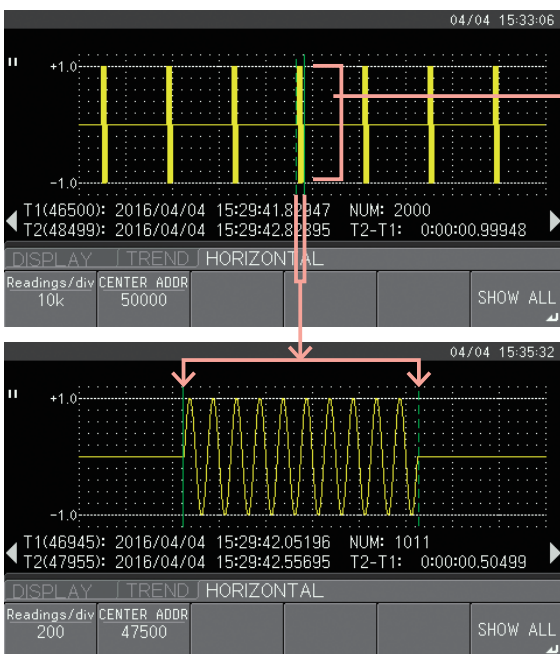

Zooming in a part of the trend chart

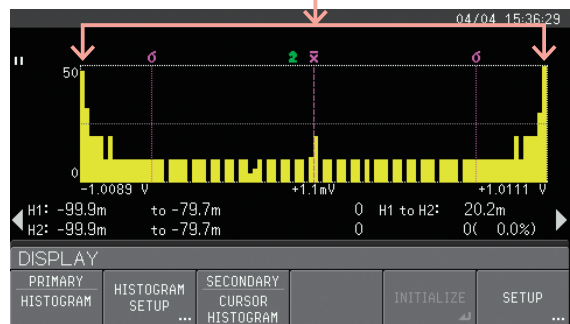

Histogram display of the voltage distribution

Productivity improvement

Judgment (GO/NO-GO) result analysis

Both the histogram and trend chart can display LIMIT judgment results. The number of captured NO-GO results is displayed in the histogram display, and the timing when NO-GO results were captured is clearly displayed in the trend chart.

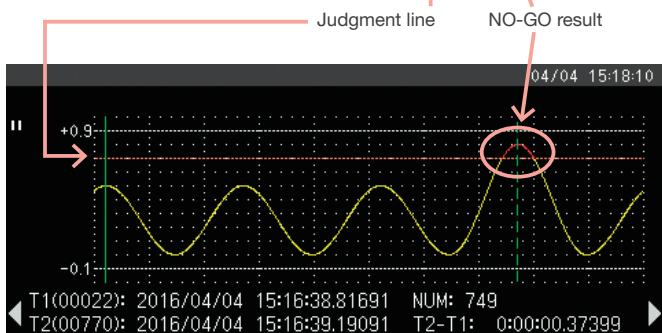
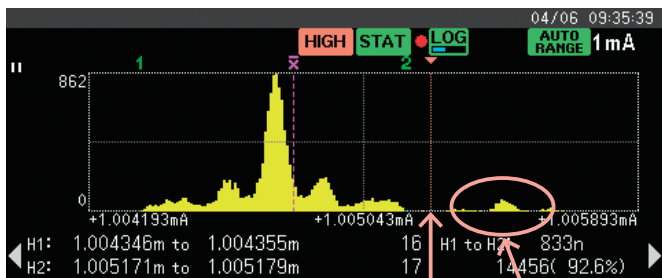

Display in large fonts

Easily seen from a distance.



Setup control by PLCs

The DM7560 can store/recall up to 10 setups through the optional RS-232 interface to enable flexible control of the instrument from a PLC.

Signal output according to LIMIT judgment

A LIMIT judgment result can be output as a signal from the DIO terminals (option) for simplified implementation of automated test systems.

SCPI-compliant remote control

In addition to the standard USB interface, Ethernet, RS-232 and GP-IB are also available and control is available through industry-standard SCPI commands.

Rear panel

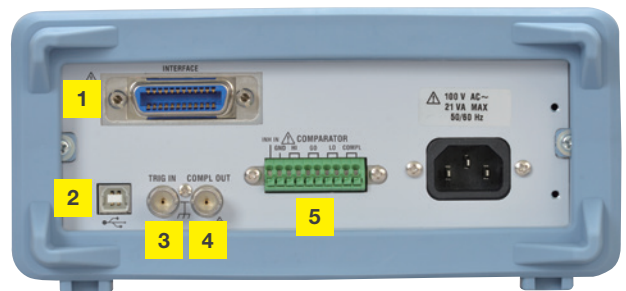

*The figure is an example for /C1/CMP options

- | | |
|--|-------------------------|
| 1 GP-IB terminal (/C1)
LAN & RS-232
terminal (/C2) | 3 TRIG IN terminal |
| 2 USB terminal | 4 COMPLETE OUT terminal |
| | 5 DIO terminal (/CMP) |

Specifications

Basic measuring function

The specifications below are under the following conditions and definitions:
 Temp./humid.: 23±5°C, 80%RH or less
 Specifications are valid for 1 year.
 Response time: Time that measurement enters into the accuracy in each range
 The unit of Tempco* of ACV and ACI functions is ±(% of reading + % of range) /°C
 *The word of "Tempco" means the temperature coefficient in this bulletin.

Common specifications

Measurement method	Delta-sigma A/D converter
Measurement mode	Trigger setting mode AUTO/SINGLE (selectable)
Range	Selectable from AUTO RANGE/MANUAL RANGE AUTO range: The range is increased when the value exceeds "1199999", and decreased when the value falls below "100000".

Sampling rate

Power freq.: 50 Hz		Power freq.: 60 Hz		Display digit	Remarks
Sampling rate ¹ (S/s)	PLC converted value ²	Sampling rate ¹ (S/s)	PLC converted value ²		
2.5 (1)	20	2.5 (1)	24	6 $\frac{1}{2}$	Figures in () are AUTO ZERO ON or at 4 WΩ
10 (4)	5	10 (4)	6		
50 (20)	1	60 (20)	1		
100	0.5	100	0.6		
500	0.1	500	0.12		
1 k	0.05	1 k	0.06	5 $\frac{1}{2}$	This setting doesn't exist at 4 WΩ
2 k	25 m	2 k	0.03		
7.5 k	6.67 m	7.5 k	8 m		
15 k	3.33 m	15 k	4 m		
30 k	1.67 m	30 k	2 m		

Sampling rate

AC filter	Sampling rate		Display digit	Response time ³
	Power freq.: 50 Hz	Power freq.: 60 Hz		
MID	2.5 S/s (20PLC)	2.5 S/s (24PLC)	6 $\frac{1}{2}$	Within 3 s
	2.5 S/s (20PLC)	2.5 S/s (24PLC)		
HIGH	10 S/s (5PLC)	10 S/s (6PLC)		
	50 S/s (1PLC)	60 S/s (1PLC)		

*1 The sampling rate is guaranteed only when the mode of the Logging function is in the BULK mode.

*2 The PLC converted value corresponds to the sampling cycle/power cycle value.

*3 Time to reach ±100 digits of final value when input changes from 0 to full-scale in the same range.

DC voltage (DCV)

Accuracy

Range	Full scale at 6 $\frac{1}{2}$ digits	Resolution	Accuracy ±(% of reading + % of range)	Tempco ±(% of reading + % of range)/°C	Input impedance
100 mV	119.9999	0.1 μV	0.0050 + 0.0035	0.0005 + 0.0005	1 GΩ or more or 10 MΩ ±1%
1 V	1.199999	1 μV	0.0040 + 0.0007	0.0005 + 0.0001	
10 V	11.99999	10 μV	0.0035 + 0.0005		10 MΩ ±1%
100 V	119.9999	0.1 mV	0.0045 + 0.0006	10 MΩ ±1%	
1000 V	1100.000	1 mV	0.0045 + 0.0010		

- Sampling rate: 1 S/s
- Max. allowable voltage
100 mV to 100 V range: 800 Vpeak (continuous), 1100 Vpeak (for 1 minute)
1000 V range: ±1100 Vpeak (continuous)
- Response time: Within 1 s

Noise rejection

PLC	NMRR 50 Hz/60 Hz ±0.1%	CMRR 50 Hz/60 Hz ±0.1% Unbalance resistance 1 kΩ
Multiple of 1 PLC	55 dB	120 dB
Other than above	0 dB	—

Power frequency: 50 Hz/60 Hz

AC voltage (ACV)

Resolution and measuring frequency range

Range	Full scale	Resolution	Measuring frequency range		Input impedance
			MID	HIGH	
100 mV	119.9999	0.1 μV	20 Hz to 300 kHz	200 Hz to 300 kHz	Approx. 1 MΩ// 100 pF or less
1 V	1.199999	1 μV			
10 V	11.99999	10 μV			
100 V	119.9999	0.1 mV			
750 V	750.000	1 mV	20 Hz to 100 kHz	200 Hz to 100 kHz	

True RMS, crest factor < 5

Accuracy

Specified between 5% and 100% of each range.

Range	Frequency	Unit of accuracy: ±(% of reading + % of range)	
		Accuracy	Tempco
100 mV	20 Hz to 45 Hz	0.70 + 0.04	0.070 + 0.004
	45 Hz to 100 Hz	0.20 + 0.04	0.020 + 0.004
	100 Hz to 20 kHz	0.06 + 0.04	0.005 + 0.004
	20 kHz to 50 kHz	0.12 + 0.05	0.011 + 0.005
	50 kHz to 100 kHz	0.60 + 0.08	0.060 + 0.008
1 V to 750 V	100 kHz to 300 kHz	4.00 + 0.50	0.200 + 0.020
	20 Hz to 45 Hz	0.70 + 0.03	0.070 + 0.003
	45 Hz to 100 Hz	0.20 + 0.03	0.020 + 0.003
	100 Hz to 20 kHz	0.06 + 0.03	0.005 + 0.003
	20 kHz to 50 kHz	0.11 + 0.05	0.011 + 0.005
1 V to 750 V	50 kHz to 100 kHz	0.60 + 0.08	0.060 + 0.008
	100 kHz to 300 kHz	4.00 + 0.50	0.200 + 0.020

- Sampling rate: 2.5 S/s
- Sine wave input
- Maximum allowable voltage 750 Vrms or 1100 Vpeak and DC content are ±500 V or less.
- Limited to 100 kHz or 8×10⁷ [V·Hz] at the 750 V range.

Additional error by AC filter setting

AC filter	Unit: ±(% of reading)				
	20 Hz to 40 Hz	40 Hz to 100 Hz	100 Hz to 200 Hz	200 Hz to 1 kHz	Over 1 kHz
MID	0.22	0.06	0.01	0	0
HIGH	—	0.73	0.22	0.18	0

Additional error by crest factor

Crest factor	Unit: ±(% of range)	
	Additional error of crest factor	Additional error of bandwidth
1 to 2	0.1	0.00015 × f
2 to 3	0.3	0.00024 × f
3 to 4	0.5	0.00060 × f
4 to 5	1.2	0.00150 × f

f is basic frequency [Hz] of input signal.

DC current (DCI)

Accuracy

Range	Full scale at 6 $\frac{1}{2}$ digits	Resolution	Accuracy ±(% of reading + % of range)	Tempco ±(% of reading + % of range)/°C	Input impedance
1 mA	1.199999	1 nA	0.050 + 0.006	0.0020 + 0.0050	90 Ω
10 mA	11.99999	10 nA	0.050 + 0.020	0.0020 + 0.0020	5 Ω
100 mA	119.9999	100 nA	0.050 + 0.005	0.0020 + 0.0005	5 Ω
1 A	1.199999	1 μA	0.100 + 0.010	0.0050 + 0.0010	0.1 Ω
3 A	3.00000	10 μA	0.120 + 0.020	0.0050 + 0.0020	0.1 Ω

- Sampling rate: 1 S/s
- Resolution is specified when the display digit is 6 $\frac{1}{2}$ digit.
- Maximum allowable current
Full range: 3 ADC or 3 Arms (continuous, protection by 3 A fuse)

AC current (ACI)

Resolution and measuring frequency range

Range	Full scale	Resolution	Measuring frequency range		Input impedance
			MID	HIGH	
1 A	1.199999	1 μA	20 Hz to 5 kHz	200 Hz to 5 kHz	0.1 Ω
3 A	3.00000	10 μA			

True RMS, crest factor < 5

Accuracy

Specified between 5% and 100% of each range.

Unit of accuracy: \pm (% of reading + % of range)

Range	Frequency	Accuracy	Tempco
1 A	20 Hz to 45 Hz	0.70 + 0.04	0.100 + 0.006
	45 Hz to 100 Hz	0.30 + 0.04	0.035 + 0.006
	100 Hz to 5 kHz	0.10 + 0.04	0.015 + 0.006
3 A	20 Hz to 45 Hz	0.70 + 0.06	0.100 + 0.006
	45 Hz to 100 Hz	0.35 + 0.06	0.035 + 0.006
	100 Hz to 5 kHz	0.15 + 0.06	0.015 + 0.006

- Sampling rate: 2.5 S/s
- Sine wave input
- Maximum allowable current
Full range: 3 Arms (continuous, protection by 3 A fuse)

Additional error by AC filter

Unit: \pm (% of reading)

AC filter	20 Hz to 40 Hz	40 Hz to 100 Hz	100 Hz to 200 Hz	200 Hz to 1 kHz	Over 1 kHz
MID	0.22	0.06	0.01	0	0
HIGH	—	0.73	0.22	0.18	0

Additional error by crest factor

Unit: \pm (% of range)

Crest factor	Additional error of crest factor	Additional error of bandwidth
1 to 2	0.1	0.00015 × f
2 to 3	0.3	0.00024 × f
3 to 4	0.5	0.00060 × f
4 to 5	1.2	0.00150 × f

f is basic frequency [Hz] of input signal.

2-terminal resistance (2 W Ω), 4-terminal resistance (4 W Ω)

Range	Full scale at $6\frac{1}{2}$ digits	Resolution	Accuracy \pm (% of reading + % of range)	Tempco \pm (% of reading + % of range)/°C	Measuring current (Approx.)
100 Ω	119.9999	0.1 m Ω	0.010 + 0.004	0.0006 + 0.0005	1 mA
1 k Ω	1.199999	1 m Ω	0.010 + 0.001	0.0006 + 0.0001	1 mA
10 k Ω	11.99999	10 m Ω	0.010 + 0.001	0.0006 + 0.0001	100 μ A
100 k Ω	119.9999	0.1 Ω	0.010 + 0.001	0.0006 + 0.0001	10 μ A
1 M Ω	1.199999	1 Ω	0.010 + 0.001	0.0010 + 0.0002	5 μ A
10 M Ω	11.99999	10 Ω	0.040 + 0.001	0.0030 + 0.0004	500 nA
100 M Ω	119.9999	100 Ω	0.800 + 0.010	0.1500 + 0.0002	500 nA //10 M Ω

- Sampling rate: 1 S/s
- This is accuracy by $6\frac{1}{2}$ digits resolution for 4-terminal resistance measurement or 2-terminal resistance measurement after zero compensation by NULL calculation. In the case NULL calculation is not performed, 0.2 Ω additional tolerance is added to 2-terminal resistance measurement.
- Maximum allowable voltage
Between Ω -COM terminals: 800 Vpeak (continuous) or 1100 Vpeak (for 1 min.)
Between Sense Hi-Lo: 200 Vpeak
- Terminal open voltage < 17 V

Continuity test (CONT \blacksquare)

Resistance range	Resolution	Threshold	Accuracy \pm (% of reading + % of range)	Tempco \pm (% of reading + % of range)/°C
1 k Ω	10 m Ω	1 Ω to 1000 Ω	0.010 + 0.020	0.001 + 0.002

Resistance range	Measuring Current	Sampling rate
1 k Ω	Approx. 1 mA	100 S/s

- Sounding of electronic buzzer
- Maximum allowable voltage: 800 Vpeak (continuous), 1100 Vpeak (for 1 min.)

Diode test (\blacktriangleright)

Measuring current	Measuring range	Accuracy \pm (% of reading + % of range)	Tempco \pm (% of reading + % of range)/°C
Approx. 1 mA	0.01 mV to 1.19999 V	0.010 + 0.020	0.001 + 0.002

Measuring current	Terminal open voltage	Sampling rate
Approx. 1 mA	< 17 V	100 S/s

Maximum allowable voltage: 800 Vpeak (continuous), 1100 Vpeak (for 1 min.)

Temperature (TEMP, TC: Thermocouple)

[NOTICE] Internal reference junction compensation is not supported. Need to enter fixed value as the reference junction compensation temperature manually.

Unit: \pm (% of reading + °C)

Thermocouple	Measuring range (°C)	Accuracy	Resolution	Max. allowable voltage
R	-50 to 0	0.20 + 0.70	0.001°C	800 Vpeak (continuous) 1100 Vpeak (for 1 minute)
	0 to +100	0.20 + 0.50		
	+100 to +1765	0.20 + 0.30		
K (CA)	-200 to -100	0.15 + 0.50		
	-100 to 0	0.15 + 0.35		
	0 to +1370	0.15 + 0.20		
T (CC)	-200 to -100	0.15 + 0.50		
	-100 to 0	0.15 + 0.35		
	0 to +400	0.15 + 0.20		
J (IC)	-200 to -100	0.15 + 0.50		
	-100 to 0	0.15 + 0.35		
	0 to +1200	0.15 + 0.20		
E (CRC)	-200 to -100	0.15 + 0.50		
	-100 to 0	0.15 + 0.35		
	0 to +1000	0.15 + 0.20		

- Sampling rate: 1 S/s
- Thermocouple accuracy not included.
- Cold junction temperature* shall be input by TEMP/SENSOR menu and does not include its error.
- In calculational guarantee temperature 0°C to 18°C and 28°C to 50°C, $\pm 0.1^\circ\text{C}/^\circ\text{C}$ is added to all thermocouples.
- Standard heat electromotive force depends on line graph approximate calculation by JIS 1602.
- * "Cold junction temperature" is same as "Reference junction compensation temperature".

Temperature (TEMP, RTD: Resistance temperature detector)

RTD	Measuring range (°C)	Accuracy	Tempco	Resolution
Pt100	-200 to +850	$\pm 0.06^\circ\text{C}$	$\pm 0.003^\circ\text{C}/^\circ\text{C}$	0.01°C
JPt100	-200 to +510			

- Sampling rate: 1 S/s
- Complies with JIS C1604 standards.
- In 4-lead wire system, accuracy of measuring cable (or probe) is not included.
- Maximum allowable voltage: Between Ω -COM terminals: 800 Vpeak (continuous) or 1100 Vpeak (for 1 min.) Between Sense Hi-Lo: 200 Vpeak

Frequency (FREQ)

AC coupling, reciprocal counting, crest factor < 5

Gate time	Display digit number and measuring range	Accuracy (% of reading)			
		3 to 5 Hz	5 to 10 Hz	10 to 40 Hz	40 Hz to 300 kHz
1 s	7 digits: 3.000000 Hz to 300.0000 kHz	0.1	0.05	0.03	0.01
100 ms	6 digits: 3.00000 Hz to 300.000 kHz				
10 ms	5 digits: 3.0000 Hz to 300.00 kHz				
1 ms	4 digits: 3.000 Hz to 300.0 kHz				

- Maximum allowable voltage: 750 Vrms, or 1100 Vpeak (continuous), however DC content is ± 500 V or less.
- An input attenuator is the case when 100 mV to 750 V range of ACV is switched automatically or manually.
- An input range is 100 mVrms to 750 Vrms at 3 Hz to 100 kHz. However up to maximum 2.2×10^7 [V·Hz] in 100 kHz to 300 kHz.
- Up to 100 kHz when input is 200 Vrms or more.
- In the input 3 Hz or less and more than 300 kHz, measuring and display may be performed but it is out of accuracy guarantee.

Trigger function

Trigger mode	AUTO: Measures automatically in accordance with sampling rate and interval. SINGLE: Measures in accordance with TRIG input
Trigger source	Rear TRIG input terminal: Polarity and valid/invalid are switchable by menu HOLD/TRIG key: Enters by key manually REMOTE: Operated by remote commands
Trigger sample number	Sets the number of continuous data measurement per one trigger Setting range: 1 to 100000
Trigger delay	Sets delay time from TRIG input to data measurement Setting range: 0.00 ms to 3600 s (Resolution: 10 μ s)
Interval	Measuring interval setting of sampling. This is valid when larger value than current sampling rate is set. Setting range: 0.00 ms to 3600 s (Resolution: 10 μ s)

Calculation function

Simultaneous setting is possible except for combination of scaling and decibel calculation.

SMOOTHING (Moving average) calculation

Average count	Selectable in range of 2 to 100 (positive integer). In case trigger is SINGLE, after it reaches the set average count, required trigger sample quantity is obtained.
---------------	--

NULL (Difference) calculation

Calculation	Calculation result = RAW value – NULL value RAW value: Measured value of function at that time NULL value: Stored value set by the following operation
Setting	Calculation ON/OFF On/Off are set by [NULL] key or NULL menu of each function. When turning on with the NULL key, the measured value at that time is set to NULL value of each function. NULL value setting It is possible to set it by three kinds (DEFAULT value, measurements, and a numeric input) when setting according to the NULL menu of each function. Numerical setting by NULL VAL menu of each function manually. With multiplier (p, n, μ , m, k, M, G, T), effective figures 7 digits.

Scaling (SCALING) calculation

Calculation formula	Selectable from the following two formulas: • Display value = $\frac{(\text{measured value} - A) \times B}{C}$ • Display value = $\frac{D}{\text{measured value}}$
Constant	The 4 constants of A, B, C, D are set. With multiplier (p, n, μ , m, k, M, G, T), effective figures 7 digits.

dB calculation

Calculation	Selectable from dBm and dBV:
dBm	Calculation result = $10 \cdot \log_{10} \left\{ \frac{\left(\frac{\text{measured value}^2}{\text{standard resistance}} \right)}{(1.0 \times 10^{-9})} \right\}$ Standard resistance value: Selection of 4, 8, 16, 32, 50, 75, 93, 110, 124, 125, 135, 150, 200, 250, 300, 500, 600, 800, 900, 1000, 1200, 8000 Ω
dBV	Calculation result = $20 \cdot \log_{10} \left(\frac{ \text{measured value} }{\text{standard voltage}} \right)$ Standard voltage value: Selection of 1 μ V, 1 mV, 1 V
REL calculation	Possible to set by above 2 calculations. Display of different value deducted dB standard value from calculation result.
dB standard value	Selectable from three types (DEFAULT value, measured value, numeric input). Setting range is ± 500.0000 (Seven significant digits)
Appropriate function	Valid only for DCV and ACV functions

STATISTIC calculation

Calculation	Calculates maximum (MAX), minimum (MIN), average (AVE) and standard deviation (σ)
Display	Possible to display on secondary display. The average value cursor and the σ cursor are displayed in the histogram chart.

LIMIT calculation

Judgment	ON/OFF	The upper limit and the lower limit can be enabled/disabled independently.
LIMIT value		The upper limit and the lower limit values are set in seven significant digits with eight kinds of multiplier (p, n, μ , m, k, M, G, T)
HIGH		Measurement value > the upper limit value
LOW		Measurement value < the lower limit value
GO		When either or both HIGH judgment and LOW judgment is ON, the state that is neither HIGH nor LOW.
Display	Trend chart	Displays HIGH/LOW marks and threshold line in graphics
	Histogram chart	Displays HIGH/LOW marks and threshold line in graphics
	LIMIT judgment	Displays HIGH/LOW on the primary and secondary displays and the upper part of the screen

Logging function

Switchable between 2 modes, NORMAL and BULK

Data size	NORMAL mode: Fixed to 100 k points BULK mode: 1 k, 2 k, 5 k, 10 k, 20 k, 50 k, 100 k points
Data to be saved	• Measurement data • Date and time of logging • Name of each function • Configuration of each function The name of calculation (NULL, dB or SCALING) which is set to ON is displayed.
Export function	Data can be saved to USB memory
File format	Text file
Saved data	Measurement value, time stamp (can be set to OFF), attribute information (can be set to OFF)
Time stamp format	YYYY/MM/DD HH: mm: SS, xxxxxx (x: units of μ sec)
Attribute information	The name of calculation (NULL, dB, or SCALING) which is set to ON is saved.

NORMAL mode

Measurement data is stored in the memory, monitored in real-time. The sampling rate won't be constant.

BULK mode

The sampling rate is kept constant. Measurement data cannot be monitored in real-time. Unavailable in the trigger SINGLE mode.

LOG start	By pressing START LOG menu key
LOG stop	By 2 methods below: • After the STOP EVENT occurs, the data corresponding to the number of post triggers has been completely acquired. • By pressing STOP LOG Key

STOP EVENT

Selectable from the following four events:

- NONE: No condition is specified.
- EXT TRIG: Makes the external trigger input an event
- LEVEL: When the measurement data exceeds a threshold value
- LIMIT: Selectable from 4 limit judgment of GO/NOGO/HIGH/LOW

LEVEL setting condition

Polarity: Selectable from Positive/Negative
Threshold: Setting range: 7 digits significant figure with multiplier (p, n, μ , m, k, M, G, T) is used for the setting.

Post readings

Selectable in the 0 to 100% (resolution 1%) of data size

Numeric value display function

Font	Selectable from 7 SEGMENT and NORMAL (gothic)
Size	Selectable from NORMAL/LARGE
Sub display	Displayable when the size is NORMAL
RAW	Display raw data before calculated when NULL calculation is ON (except for CONT and DIODE functions)
NULL	Display NULL value when NULL calculation is on (except for CONT and DIODE function)
ACV	Displays voltage of ACV (when FREQ function is selected)
FREQ	Displays frequency (when ACV function is selected)
CONT	Displays OPEN/CLOSE (when CONT function is selected)

Trend chart display function

Online trend chart display function

Number of display data
Up to 100 k points
Horizontal axis: 401 dots (10 div)
Vertical axis: 121 dots (12 div)

Display method
At first data is displayed from left, and when waveform reached the right end of the screen, data is displayed in compressed format. After compression display of 100 k, it becomes roll mode display.

VERTICAL axis

MANUAL	Range and offset can be set manually Range: 1 p/div to 500 T/div Offset: -100000 div to +100000 div Offset setting resolution: 1 div
AUTO	Displays by updating to scale which is possible to display max/min values of measured data from obtained data automatically
FULL SCALE	Max/min values of measuring range is displayed by scale which is possible to display. Under the following conditions, FULLSCALE cannot be selected: (It becomes AUTO). • In the case of frequency function (FREQ) • When SCALING calculation (D/X) is set

Offline trend chart display function
Trend chart display can be selected in the offline browse mode too.

VERTICAL
Same setting as online setting can be made.

HORIZONTAL

Readings/div (The number of data displayed per 1 div: 1, 2, 5, 10, 20, 50, 100, 200, 500, 1 k, 2 k, 5 k, 10 k)
CENTER ADDR 0 to number of data of log memories
SHOW ALL The entire LOG memory is displayed

T1, T2 cursor function

SEARCH MODE (edge search)
The function makes jump to the nearest data depending on the condition below in the direction the rotary knob.

LIMITGO	GO of LIMIT judgment
LIMITNOGO	NOGO of LIMIT judgment
LIMITHIGH	HIGH of LIMIT judgment
LIMITLOW	LOW of LIMIT judgment
EDGEPOSITIVE	Data when the edge level is crossed in the positive direction
EDGENEGATIVE	Data when the edge level is crossed in the negative direction
EDGEBOTH	Data when the edge level is crossed in both direction

EDGE LEVEL
Settable when EDGEPOSITIVE/EDGENEGATIVE/EDGEBOTH is selected in the edge search function
Setting range
Seven significant digits with multiplier (p, n, μ, m, k, M, G, T)

Secondary display
Time display
Time stamps of measured data specified by T1 and T2 cursors
Number of data between T1 and T2 cursors
Time difference between T1 and T2 cursors
Measured value display
Maximum and minimum values of measurement data specified by T1 and T2 cursors. Measured data drawn in the same pixel on the screen is included.

Histogram chart display function

Online histogram chart display function

Vertical axis scaling
Autoscaling based on the occurrence frequency. Display unit is selectable from COUNT and PERCENT.

Horizontal axis scaling
Selectable from MANUAL, AUTO, and FULLSCALE

Number of BINS
Selectable from 2, 4, 5, 10, 20, 40, 50, 100, 200, and 400

MANUAL	Center value	Seven significant digits with multiplier (p, n, μ, m, k, M, G, T)
	Span	±100 p to ±500 T (Set by 1-2-5 step with multiplier)

AUTO
By using the maximum and minimum values of the data collected in this period, the center value and span of the histogram are decided.

FULL SCALE
A central value and span are decided according to the full-scale of a measurement range. It works as the AUTO mode under the following conditions because the maximum and minimum values cannot be decided.
• When the function is FREQ or TEMP
• When the scaling calculation (D/X) is set
• When dB calculation is set

Statistical cursor
The positions of the average value \bar{x} and standard deviation σ are indicated by cursors. (When the statistics calculation is ON)
 σ : Selectable from 1 σ to 6 σ

H1, H2 cursor function

Secondary display
Range of BIN measurement value of H1 and H2 cursors.
Count of BIN of H1 and H2 cursors.
Range of measurement value between H1 and H2 cursors.
Count and ratio (%) between H1 and H2 cursors.

Offline histogram chart display function
Histogram chart display can be selected in the offline browse mode too.
The setting method of the display mode, the number of BIN, vertical axis, horizontal axis, and cursor functions are the same as that of the online mode.

Meter display function

Arc scale meter display function (Primary display only)

Mode: Selectable from AUTO, FULLSCALE, MANUAL, and LOG

LOG	LOG MAX and LOG MIN are set between 10 times and 10 ⁶
Others	Displays with offset ±6 div (In case of MANUAL, range and offset can be set) Range: 1.0 p/div to 500.0 T/div Offset: -100000 div to +100000 div

Analog meter display function (Secondary display only)

The settings are the same as those of the arc scale meter display.

Others

Communication interfaces

USB 2.0	Standard	
GP-IB	/C1 option	
GP-IB address	0 to 30	
LAN & RS-232	/C2 option	
LAN settings	DHCP (ON/OFF), IP address, Gateway, Subnet mask	
RS-232 settings	Parity	NONE, EVEN, ODD
	Stop bit	1 bit, 2 bit
	Bit rate	300, 600, 1200, 2400, 4800, 9600, 19200, 38400 bps
Remote setting common parameters		
	Delimiter: CR + LF, LF	Command: SCPI compliant
DIO	/CMP option	

Rear panel input/output (BNC and DIO)

Trigger input (BNC)	Level	H: 2.4 Vmin, L: 0.9 Vmax
	Input impedance	Approx. 10 k Ω
	Polarity	Both edges are selectable
	Pulse width	1 μ s or more
	Default delay	Less than 1 μ s
COMPLETE output (BNC)	Level	H: 2.4 Vmin, L: 0.4 Vmax
	Output impedance	Approx. 1 k Ω
	Polarity	Positive logic
	Output pulse width	At LIMIT judgment OFF: 10 μ s At LIMIT judgment ON: 4.0 ms or more

TRIG INHIBIT input (DIO option)

Level	H: 2.4 Vmin, L: 0.6 Vmax
Input impedance	Approx. 5 k Ω
Polarity	POSITIVE/NEGATIVE

LIMIT judge output (DIO option)

COMPLETE, GO, HI, LO
Output only at LIMIT judge ON and DIO output ON
Withstand voltage: 42 Vpeak
Max. allowable current: 100 mA

Signal timing

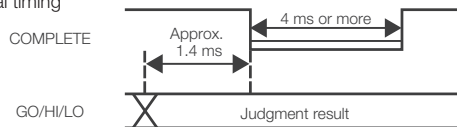

General specifications

Warm-up time	1 hour after power on
Calculation guaranteed temp./humid.	0°C to 50°C (40°C and no dew allowed below the moisture amount of 80%RH)
Storage temp./humid.	-20°C to +60°C (40°C and no dew allowed below the moisture amount of 90%RH)
Power supply	AC100 V/115 V/220 V/240 V \pm 10%, 50 Hz/60 Hz
Power consumption	21 VA or less (option included)
Withstand voltage	DC \pm 500 V (between LO terminal and ground)
Installation (over voltage) category	Category II (local level, electric product and portable product)
Pollution level	2 (Do not use it at environment which exists pollutant of electroconductive)
Dimension	225 (W) \times 100 (H) \times 366 (D) mm (protuberance such as leg, handle and knob excluded)
Weight	Approx. 3.0 kg (protector and option included)
Screen	LCD
	Size
Number of dots	480 dots \times 272 dots (The LCD may include a few defective dots. 7 dots or less.)
Color	16-bit, 65536 colors
Drive system	TFT active matrix
Back light	LED

Model and Suffix code

Model	Suffix code	Description
DM7560		Digital Multimeter
Supply voltage	-1	100 VAC, 50/60 Hz
	-3	115 VAC, 50/60 Hz
	-6	220 VAC, 50/60 Hz
	-8	240 VAC, 50/60 Hz
Power cord	-D	UL/CSA standard, PSE compliant
	-F	VED Standard
	-R	AS Standard
	-Q	BS Standard
	-H	GB Standard
	-N	NBR Standard
Options	/C1	GP-IB Interface*
	/C2	LAN & RS-232 Interface*
	/CMP	DIO Interface

*Only one can be selected.

Standard accessories: Power cord, User's manuals (1set), Spare fuses (2), Test lead (1set)

Please contact our sales representative for the rack mounting kit.

External dimensions

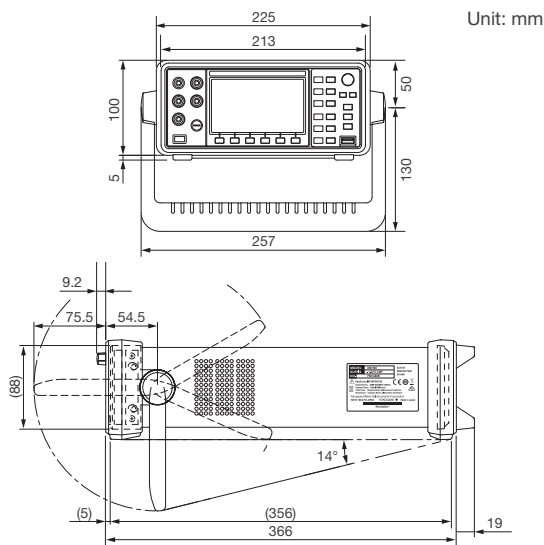

Related product



GS200 DC Voltage/Current Source

High accuracy, high stability, low noise
Output range: ± 32 V, ± 200 mA

Accessories

Model	Product	Description	
758917	Measurement lead	0.75 m safety terminal cable with 2 leads (red and black) in a set 1000 V CATIII, 600 V CATIII	
758933	Measurement lead	1 m safety terminal cable with 2 leads (red and black) in a set 1000 V CATIII	
758922	Small alligator clip adapter	Safety terminal-alligator clip adapter, containing 2 pieces (red and black) in a set 300 V CATII	
758929	Large alligator clip adapter	Safety terminal-alligator clip adapter, containing 2 pieces (red and black) in a set 1000 V CATII	
758923*	Safety terminal adapter	Spring clamp type 2 adapters (red and black) in a set 600 V CATII	
758931*	Safety terminal adapter	Screw-in type 2 adapters (red and black) in a set 1000 V CATIII	
96095	Current clamp probe	AC/DC clamp probe AC: 130 A (40 Hz to 1 kHz) DC: ± 180 A	

⚠ Due to the nature of this product, it is possible to touch its metal parts. Therefore, there is a risk of electric shock, so the product must be used with caution.

*Wire diameter of cables that can connect to the adapter

758923 Core wire diameter: 2.5 mm or less, covering diameter: 5.0 mm

758931 Core wire diameter: 1.8 mm or less, covering diameter: 3.9 mm

For your safety, please use the cable under considering usage voltage.

NOTICE

- Before operating the product, read the user's manual thoroughly for proper and safe operation.

This is a Class A instrument based on Emission standards EN61326-1 and EN55011, and is designed for an industrial environment.
Operation of this equipment in a residential area may cause radio interference, in which case users will be responsible for any interference which they cause.

YOKOGAWA



YMI-KS-MI-SE02

YOKOGAWA METERS & INSTRUMENTS CORPORATION

Global Sales Dept. /Phone: +81-422-52-6237 Facsimile: +81-422-52-6462

E-mail: tm@cs.jp.yokogawa.com

YOKOGAWA CORPORATION OF AMERICA
YOKOGAWA EUROPE B.V.
YOKOGAWA SHANGHAI TRADING CO., LTD.
YOKOGAWA ELECTRIC KOREA CO., LTD.
YOKOGAWA ENGINEERING ASIA PTE. LTD.
YOKOGAWA INDIA LTD.
YOKOGAWA ELECTRIC CIS LTD.
YOKOGAWA AMERICA DO SUL LTDA.
YOKOGAWA MIDDLE EAST & AFRICA B.S.C(c)

Phone: +1-770-253-7000
Phone: +31-88-4641000
Phone: +86-21-6239-6363
Phone: +82-2-2628-3810
Phone: +65-6241-9933
Phone: +91-80-4158-6000
Phone: +7-495-737-7868
Phone: +55-11-5681-2400
Phone: +973-17-358100

Facsimile: +1-770-254-0928
Facsimile: +31-88-4641111
Facsimile: +86-21-6880-4987
Facsimile: +82-2-2628-3899
Facsimile: +65-6241-2606
Facsimile: +91-80-2852-1441
Facsimile: +7-495-737-7869
Facsimile: +55-11-5681-4434
Facsimile: +973-17-336100

Subject to Change without notice.

Copyright © 2016, Yokogawa Meters & Instruments Corporation

[Ed: 01/b]

Printed in Japan, 607(KP)

<http://tmi.yokogawa.com/>