

Datasheet

Multi-Color General-Purpose or Audible Indicators



Standard Audible



Sealed Audible



Omni-Directional Sealed Audible

- Rugged, cost-effective, and easy-to-install multi-segment indicators
- Illuminated segments provide easy-to-see operator guidance and indication of equipment status
- Up to 7 stacked colors available
- Available in black or light gray housing
- Audible models available with standard, sealed, or omni-directional audible element
- Compact devices are completely self-contained, no controller needed
- Models with 1 to 5 segments, 18 V dc to 30 V dc or 24 V ac operation
- Models with 6 to 7 segments, 12 V dc to 30 V dc or 24 V ac operation
- No assembly required

Non-Audible Models

Model ¹	# of LED Colors	LED Colors ²	Connection ³	Inputs
TL50RQ	1	Red	Integral 4-pin M12/Euro-style male quick disconnect (QD)	Bimodal (NPN or PNP)
TL50GRQ	2	Green, Red		
TL50GYRQ	3	Green, Yellow, Red		
TL50BGYRQ	4	Blue, Green, Yellow, Red	Integral 5-pin M12/Euro-style male quick disconnect (QD)	
TL50WBGYRQ	5	White, Blue, Green, Yellow, Red	Integral 8-pin M12/Euro-style male quick disconnect (QD)	

Audible Models

Standard Audible Model ¹	# of LED Colors	LED Colors ²	Connection ³	Inputs
TL50RAQ	1	Red	Integral 4-pin M12/Euro-style male quick disconnect (QD)	Bimodal (NPN or PNP)
TL50GRAQ	2	Green, Red		
TL50GYRAQ	3	Green, Yellow, Red	Integral 5-pin M12/Euro-style male quick disconnect (QD)	
TL50BGYRAQ	4	Blue, Green, Yellow, Red	Integral 8-pin M12/Euro-style male quick disconnect (QD)	
TL50WBGYRAQ	5	White, Blue, Green, Yellow, Red		

Sealed Audible Model ¹			# of LED Colors	LED Colors ²	Connection ³	Inputs
Continuous	Pulsed at 1.6 Hz	Staccato				
TL50RALSQ	TL50RALS3Q	TL50RALS4Q	1	Red	Integral 4-pin M12/Euro-style male quick disconnect (QD)	Bimodal (NPN or PNP)
TL50GRALSQ	TL50GRALS3Q	TL50GRALS4Q	2	Green, Red		

¹ Models with black housing are listed. For gray housing, add the suffix "C" at the end of the cabled model number or before the "Q" in quick disconnect model numbers. For example, TL50RAC or TL50RACQ.

² The first color listed is the bottom color, going up in successive order. Other available colors include: Turquoise (T), Orange (O), Violet (V), Sky Blue (S) and Magenta (M).

³

- To order the 150 mm (6 in) PVC cable model with a M12/Euro-style quick disconnect, replace the suffix "Q" with "QP" in the model number. For example, TL50RAQP.
- To order the 2 m (6.5 ft) PVC cable model, omit the suffix "Q" in the model number. For example, TL50RA.
- Models with a quick disconnect require a mating cordset.



Sealed Audible Model ¹			# of LED Colors	LED Colors ²	Connection ³	Inputs	
Continuous	Pulsed at 1.6 Hz	Staccato					
TL50GYRALSQ	TL50GYRALS3Q	TL50GYRALS4Q	3	Green, Yellow, Red	Integral 5-pin M12/Euro-style male quick disconnect (OD)		
TL50BGYRALSQ	TL50BGYRALS3Q	TL50BGYRALS4Q	4	Blue, Green, Yellow, Red			
TL50WBGYRALSQ	TL50WBGYRALS3Q	TL50WBGYRALS4Q	5	White, Blue, Green, Yellow, Red	Integral 8-pin M12/Euro-style male quick disconnect (OD)		
Omni-Directional ⁴ Sealed Audible Model ¹			# of LED Colors	LED Colors ²	Connection ³		Inputs
Continuous	Pulsed at 1.6 Hz	Staccato					
TL50RAOSQ	TL50RAOS3Q	TL50RAOS4Q	1	Red	Integral 4-pin M12/Euro-style male quick disconnect (OD)	Bimodal (NPN or PNP)	
TL50GRAOSQ	TL50GRAOS3Q	TL50GRAOS4Q	2	Green, Red			
TL50GYRAOSQ	TL50GYRAOS3Q	TL50GYRAOS4Q	3	Green, Yellow, Red	Integral 5-pin M12/Euro-style male quick disconnect (OD)		
TL50BGYRAOSQ	TL50BGYRAOS3Q	TL50BGYRAOS4Q	4	Blue, Green, Yellow, Red	Integral 8-pin M12/Euro-style male quick disconnect (OD)		
TL50WBGYRAOSQ	TL50WBGYRAOS3Q	TL50WBGYRAOS4Q	5	White, Blue, Green, Yellow, Red			
Omni-Directional ⁴ Sealed Audible Model with Intensity Adjustment ¹			# of LED Colors	LED Colors ²	Connection ³	Inputs	
Continuous	Pulsed at 1.6 Hz	Staccato					
TL50RAOSIQ	TL50RAOS3IQ	TL50RAOS4IQ	1	Red	Integral 4-pin M12/Euro-style male quick disconnect (OD)	Bimodal (NPN or PNP)	
TL50GRAOSIQ	TL50GRAOS3IQ	TL50GRAOS4IQ	2	Green, Red			
TL50GYRAOSIQ	TL50GYRAOS3IQ	TL50GYRAOS4IQ	3	Green, Yellow, Red	Integral 5-pin M12/Euro-style male quick disconnect (OD)		
TL50BGYRAOSIQ	TL50BGYRAOS3IQ	TL50BGYRAOS4IQ	4	Blue, Green, Yellow, Red	Integral 8-pin M12/Euro-style male quick disconnect (OD)		
TL50WBGYRAOSIQ	TL50WBGYRAOS3IQ	TL50WBGYRAOS4IQ	5	White, Blue, Green, Yellow, Red			

Wiring Diagram — 4-Pin Models

Models with 1 to 3 segments

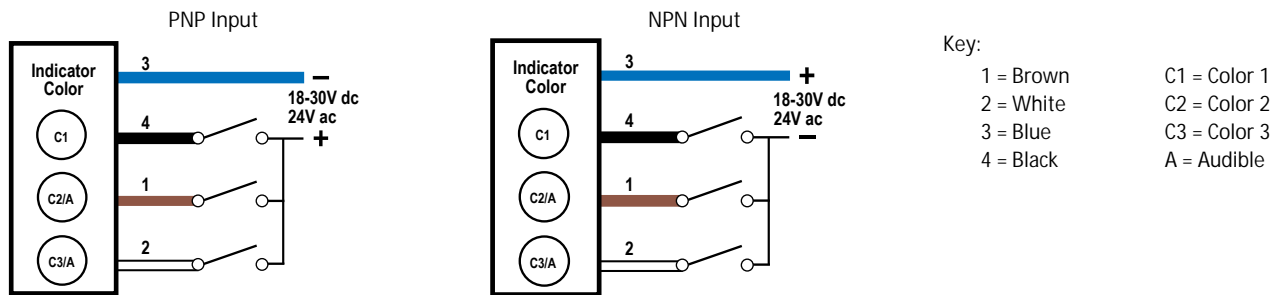

Pins 1 and 2 can activate the corresponding color or the audible function, if available.

Wiring Diagram – 5-Pin Models

Models with 4 segments

⁴ Sound exits at 45°.

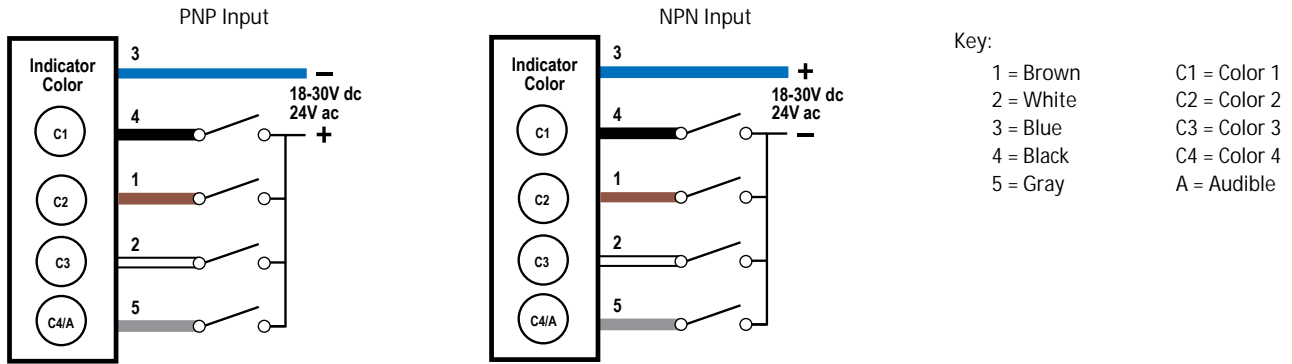

Pin 5 can activate the corresponding color or the audible function, if available.

Wiring Diagram — 8-Pin Models

Models with 5 segments

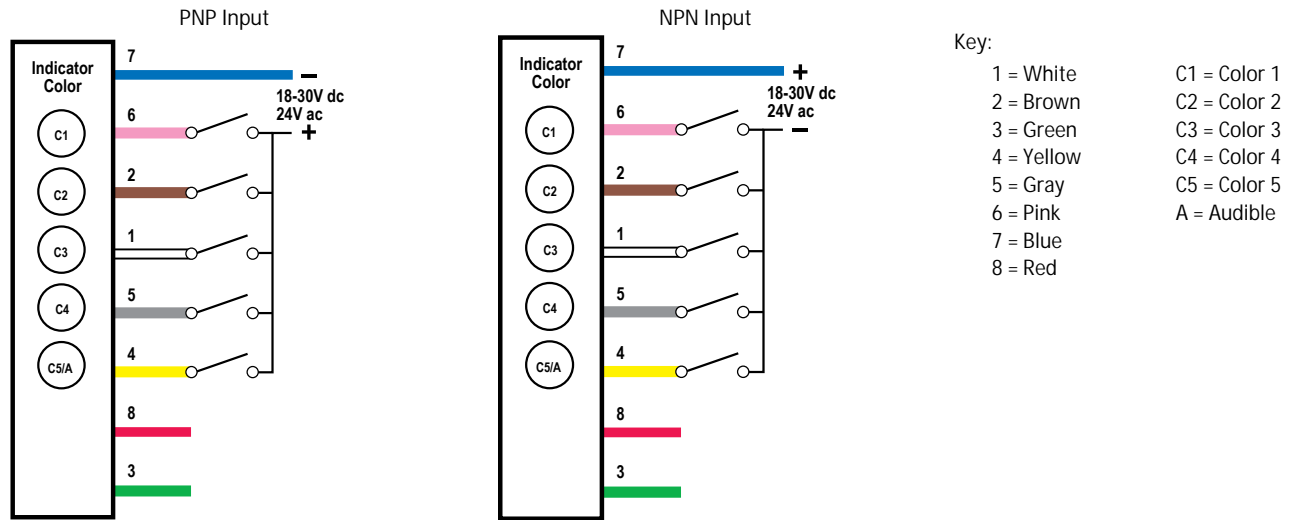

Pin 4 can activate the corresponding color or the audible function, if available. Pins 3 and 8 are not used.

Wiring Diagram — 8-Pin Models

Models with 6 to 7 segments

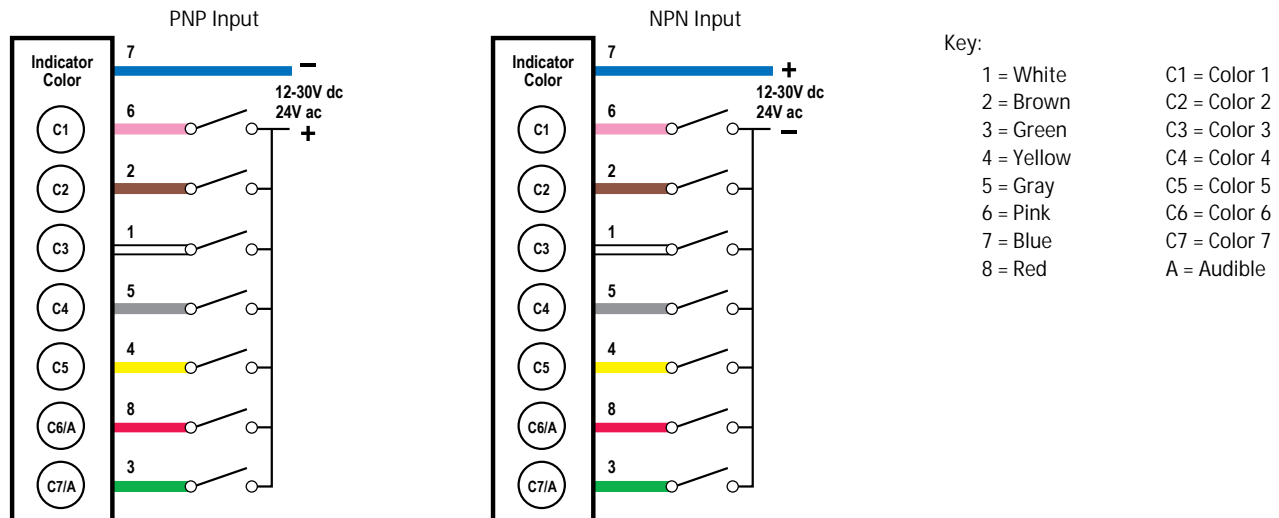

Pins 3 and 8 can activate the corresponding color or the audible function, if available.

Specifications

Supply Voltage and Current

Models with 1 to 5 segments: 18 V dc to 30 V dc; or 24 V ac (± 3 V) at 50 Hz to 60 Hz (both lights and audible alarms are counted as segments)

Indicators—maximum current per LED color: 45 mA at 18 V to 30 V dc

Models with 6 to 7 segments: 12 V dc to 30 V dc or 24 V ac (± 3 V) at 50 Hz to 60 Hz (both lights and audible alarms are counted as segments)

Indicators—maximum current per LED color:

- 135 mA at 12 V dc
- 45 mA at 30 V dc
- 60 mA at 24 V ac

Standard Audible Alarm: 25 mA maximum current

Sealed Audible Alarm: 35 mA maximum current

Omni-Directional Sealed Audible Alarm: 45 mA maximum current

Input Response Time

Indicator On/Off: 10 ms (maximum)

Audible Adjustment

Standard Audible Alarm: Unscrew the cover (up to 1.5 turns maximum) to adjust the audible intensity. (Do not exceed 1.5 turns or the cover may detach during operation.) For maximum intensity, rotate the center plug 180° counterclockwise to remove it.

Sealed Audible Alarm and **Omni-Directional** Sealed Audible Alarm with Intensity Adjustment: Rotate the front cover until the desired intensity is reached.

Omni-Directional Sealed Audible Alarm: No adjustment.

Audible Alarm

Standard Audible Alarm: 2.7 kHz \pm 500 Hz oscillation frequency; maximum intensity 92 dB at 1 m (3.3 ft) (typical)

Sealed Audible Alarm: 2.9 kHz \pm 250 Hz oscillation frequency; maximum intensity 94 dB at 1 m (3.3 ft) (typical)

Omni-Directional Sealed Audible Alarm: 2.1 kHz \pm 250 Hz oscillation frequency; maximum intensity 99 dB at 1 m (3.3 ft) (typical)

Omni-Directional Sealed Audible Alarm with Intensity Adjustment: 2.1 kHz \pm 250 Hz oscillation frequency; maximum intensity 95 dB at 1 m (3.3 ft) (typical)

Typical **Reduction** in Sound Intensity with Audible Adjustment (maximum to minimum)

- Standard Audible: 30 dB
- Sealed Audible: 20 dB
- **Omni-Directional** Sealed Audible: 12 dB

Supply **Protection** Circuitry

Protected against transient voltages

Indicators

LEDs are independently selected: 1 to 7 colors depending on model

Indicator **Characteristics**

Color	Dominant Wavelength (nm) or Color Temperature (CCT)	Color Coordinates ⁵		Lumen Output (Typical at 25 °C)
		x	y	
Green	528 nm	–	–	23.0
Red	625 nm	–	–	7.5
Yellow	590 nm	–	–	5.0
Blue	470 nm	–	–	4.0
Orange	608 nm	–	–	15.5
White	6000 K	–	–	21.0
Turquoise	–	0.19	0.37	5.5
Violet	–	0.20	0.08	2.5
Magenta	–	0.35	0.15	3.0
Sky Blue	–	0.19	0.26	12.0

⁵ Refer to CIE 1931 chromaticity diagram or color chart, to show equivalent color with indicated color coordinates.

Connections

Integral 4-pin, 5-pin, or 8-pin M12/Euro-style QD, 150 mm (6 in) PVC cable with QD, or 2 m (6.5 ft) integral cable, depending on model

Construction

Bases and Covers: ABS
Light Segment: Polycarbonate

Operating Conditions

Non-Audible: -40 °C to +50 °C (-40 °F to +122 °F)
Standard and Sealed Audible: -20 °C to +50 °C (-4 °F to +122 °F)
95% at +50 °C maximum relative humidity (non-condensing)

Vibration and Mechanical Shock

All models meet Mil Std. 202F requirements. Method 201A (vibration: 10 Hz to 60 Hz max., double amplitude 0.06 inch, maximum acceleration 10G). Also meets IEC 947-5-2 requirements: 30G 11 ms duration, half sine wave.

Environmental Rating

NEMA/UL Type 13
Non-Audible and Sealed Audible: IEC IP67
Standard Audible: IEC IP50

Certifications



Required Overcurrent Protection



WARNING: Electrical connections must be made by qualified personnel in accordance with local and national electrical codes and regulations.

Overcurrent protection is required to be provided by end product application per the supplied table.

Overcurrent protection may be provided with external fusing or via Current Limiting, Class 2 Power Supply.

Supply wiring leads < 24 AWG shall not be spliced.

For additional product support, go to www.bannerengineering.com.

Supply Wiring (AWG)	Required Overcurrent Protection (Amps)
20	5.0
22	3.0
24	2.0
26	1.0
28	0.8
30	0.5

Dimensions

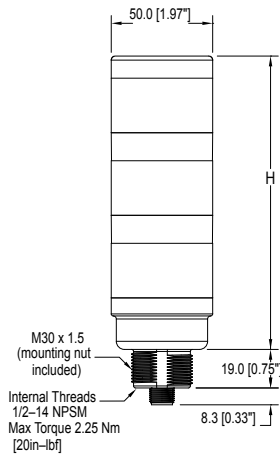

# of Colors	Tower Height (H)			
	Non-Audible	Standard Audible*	Sealed Audible	Omni-Directional Sealed Audible
1	61.2 mm (2.4 in)	92.0 mm (3.6 in)	115.1 mm (4.5 in)	129.1 mm (5.1 in)
2	101.9 mm (4.0 in)	132.7 mm (5.2 in)	155.8 mm (6.1 in)	169.8 mm (6.7 in)
3	142.6 mm (5.6 in)	173.4 mm (6.8 in)	196.5 mm (7.7 in)	210.5 mm (8.3 in)
4	183.3 mm (7.2 in)	214.1 mm (8.4 in)	237.2 mm (9.3 in)	251.2 mm (9.9 in)
5	224.0 mm (8.8 in)	254.8 mm (10.0 in)	277.9 mm (10.9 in)	291.1 mm (11.5 in)
6	264.7 mm (10.4 in)	298.5 mm (11.8 in)	318.6 mm (12.5 in)	332.6 mm (13.1 in)
7	305.4 mm (12.0 in)	-	-	-

* Tower height (H) with top unscrewed approximately 3.5 mm (0.18 in) to allow sound to escape

All measurements are listed in millimeters [inches], unless noted otherwise.

Accessories

Cordsets

4-Pin Threaded M12/Euro-Style Cordsets				
Model	Length	Style	Dimensions	Pinout (Female)
MQDC-406	1.83 m (6 ft)	Straight		
MQDC-415	4.57 m (15 ft)			
MQDC-430	9.14 m (30 ft)			
MQDC-450	15.2 m (50 ft)			

1 = Brown
2 = White
3 = Blue
4 = Black

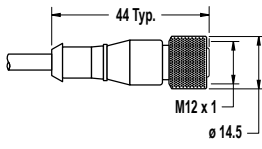
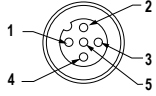
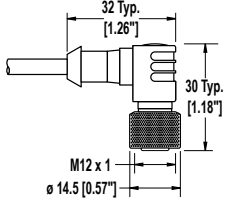
5-Pin Threaded M12/Euro-Style Cordsets—Single Ended				
Model	Length	Style	Dimensions	Pinout (Female)
MQDC1-501.5	0.50 m (1.5 ft)	Straight		 1 = Brown 2 = White 3 = Blue 4 = Black 5 = Gray
MQDC1-506	1.83 m (6 ft)			
MQDC1-515	4.57 m (15 ft)			
MQDC1-530	9.14 m (30 ft)			
MQDC1-506RA	1.83 m (6 ft)	Right-Angle		
MQDC1-515RA	4.57 m (15 ft)			
MQDC1-530RA	9.14 m (30 ft)			

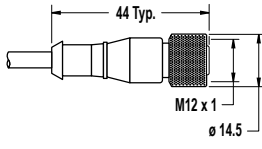
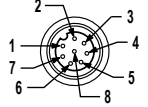
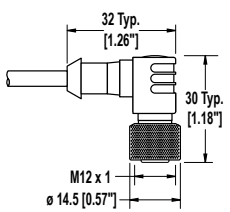
8-Pin Threaded M12/Euro-Style Cordsets with Open-Shield				
Model	Length	Style	Dimensions	Pinout (Female)
MQDC2S-806	1.83 m (6 ft)	Straight		 1 = White 2 = Brown 3 = Green 4 = Yellow 5 = Gray 6 = Pink 7 = Blue 8 = Red
MQDC2S-815	4.57 m (15 ft)			
MQDC2S-830	9.14 m (30 ft)			
MQDC2S-850	15.2 m (50 ft)			
MQDC2S-806RA	1.83 m (6 ft)	Right-Angle		
MQDC2S-815RA	4.57 m (15 ft)			
MQDC2S-830RA	9.14 m (30 ft)			
MQDC2S-850RA	15.2 m (50 ft)			

Mounting Brackets

SMB30A

- Right-angle bracket with curved slot for versatile orientation
- Clearance for M6 (¼ in) hardware
- Mounting hole for 30 mm sensor
- 12-ga. stainless steel

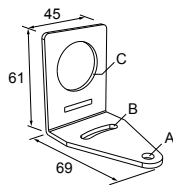

Hole center spacing: A to B=40

Hole size: A=ø 6.3, B= 27.1 x 6.3, C=ø 30.5

SMB30FA

- Swivel bracket with tilt and pan movement for precise adjustment
- Mounting hole for 30 mm sensor
- 12-ga. 304 stainless steel
- Easy sensor mounting to extrude rail T-slot
- Metric and inch size bolt available

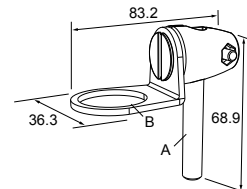

Bolt thread: SMB30FA, A= 3/8 - 16 x 2 in; SMB30FAM10, A= M10 - 1.5 x 50

Hole size: B= ø 30.1

SMB30MM

- 12-ga. stainless steel bracket with curved mounting slots for versatile orientation
- Clearance for M6 (¼ in) hardware
- Mounting hole for 30 mm sensor

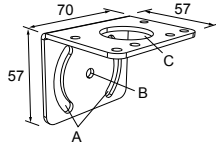

Hole center spacing: A = 51, A to B = 25.4
 Hole size: A = 42.6 x 7, B = ø 6.4, C = ø 30.1

SMBAMS30P

- Flat SMBAMS series bracket
- 30 mm hole for mounting sensors
- Articulation slots for 90°+ rotation
- 12-ga. 300 series stainless steel

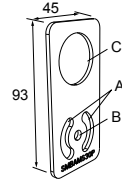

Hole center spacing: A=26.0, A to B=13.0
 Hole size: A=26.8 x 7.0, B=ø 6.5, C=ø 31.0

SMBAMS30RA

- Right-angle SMBAMS series bracket
- 30 mm hole for mounting sensors
- Articulation slots for 90°+ rotation
- 12-ga. (2.6 mm) cold-rolled steel

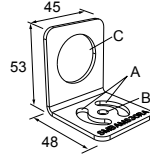

Hole center spacing: A=26.0, A to B=13.0
 Hole size: A=26.8 x 7.0, B=ø 6.5, C=ø 31.0

SMB30SC

- Swivel bracket with 30 mm mounting hole for sensor
- Black reinforced thermoplastic polyester
- Stainless steel mounting and swivel locking hardware included

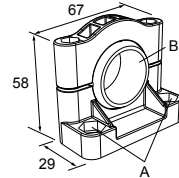

Hole center spacing: A=ø 50.8
 Hole size: A=ø 7.0, B=ø 30.0

All measurements are listed in millimeters [inches], unless noted otherwise.

LMB Sealed Right-Angle Bracket

Model	Description	Construction	
LMB30RA	Direct-Mount Models: Bracket kit with base, 30 mm adapter, set screw, fasteners, o-rings, and gaskets	Black polycarbonate	
LMB30RAC		Gray polycarbonate	
LMBE12RA	Pipe-Mount Models: Bracket kit with base, ½-14 pipe adapter, set screw, fasteners, o-rings, and gaskets. For use with stand-off pipe (listed and sold separately)	Black polycarbonate	
LMBE12RAC		Gray polycarbonate	

Elevated Mount System

Model	Features			Components
SA-M30TE12 - Black Acetal	<ul style="list-style-type: none"> • Streamlined black acetal or white UHMW stand-off pipe adapter/cover • Connects between 30 mm light base and ½ in. NPSM/DN15 pipe • Mounting hardware included 			
SA-M30TE12C - White UHMW				
Polished 304 Stainless Steel	Black Anodized Aluminum	Clear Anodized Aluminum	<ul style="list-style-type: none"> • Elevated-use stand-off pipe (½ in. NPSM/DN15) • Polished 304 stainless steel, black anodized aluminum, or clear anodized aluminum surface • ½ in. NPT thread at both ends • Compatible with most industrial environments 	
SOP-E12-150SS 150 mm (6 in) long	SOP-E12-150A 150 mm (6 in) long	SOP-E12-150AC 150 mm (6 in) long		
SOP-E12-300SS 300 mm (12 in) long	SOP-E12-300A 300 mm (12 in) long	SOP-E12-300AC 300 mm (12 in) long		
SOP-E12-900SS 900 mm (36 in) long	SOP-E12-900A 900 mm (36 in) long	SOP-E12-900AC 900 mm (36 in) long		
SA-E12M30 - Black Acetal	<ul style="list-style-type: none"> • Streamlined black acetal or white UHMW mounting base adapter/cover • Connects between ½ in. NPSM/DN15 pipe and 30 mm (1-3/16 in) drilled hole • Mounting hardware included 			
SA-E12M30C - White UHMW				

Pipe Mounting Flange

Pipe Mounting Flange			
Model	Features	Construction	
SA-F12	<ul style="list-style-type: none"> For use elevated stand-off pipes (½ in, NPSM/DN15) M5 mounting hardware and nitrile gasket included 	Die-cast zinc base with black paint	

Banner Engineering Corp. Limited Warranty

Banner Engineering Corp. warrants its products to be free from defects in material and workmanship for one year following the date of shipment. Banner Engineering Corp. will repair or replace, free of charge, any product of its manufacture which, at the time it is returned to the factory, is found to have been defective during the warranty period. This warranty does not cover damage or liability for misuse, abuse, or the improper application or installation of the Banner product.

THIS LIMITED WARRANTY IS EXCLUSIVE AND IN LIEU OF ALL OTHER WARRANTIES WHETHER EXPRESS OR IMPLIED (INCLUDING, WITHOUT LIMITATION, ANY WARRANTY OF MERCHANTABILITY OR FITNESS FOR A PARTICULAR PURPOSE), AND WHETHER ARISING UNDER COURSE OF PERFORMANCE, COURSE OF DEALING OR TRADE USAGE.

This Warranty is exclusive and limited to repair or, at the discretion of Banner Engineering Corp., replacement. IN NO EVENT SHALL BANNER ENGINEERING CORP. BE LIABLE TO BUYER OR ANY OTHER PERSON OR ENTITY FOR ANY EXTRA COSTS, EXPENSES, LOSSES, LOSS OF PROFITS, OR ANY INCIDENTAL, CONSEQUENTIAL OR SPECIAL DAMAGES RESULTING FROM ANY PRODUCT DEFECT OR FROM THE USE OR INABILITY TO USE THE PRODUCT, WHETHER ARISING IN CONTRACT OR WARRANTY, STATUTE, TORT, STRICT LIABILITY, NEGLIGENCE, OR OTHERWISE.

Banner Engineering Corp. reserves the right to change, modify or improve the design of the product without assuming any obligations or liabilities relating to any product previously manufactured by Banner Engineering Corp. Any misuse, abuse, or improper application or installation of this product or use of the product for personal protection applications when the product is identified as not intended for such purposes will void the product warranty. Any modifications to this product without prior express approval by Banner Engineering Corp will void the product warranties. All specifications published in this document are subject to change; Banner reserves the right to modify product specifications or update documentation at any time. Specifications and product information in English supersede that which is provided in any other language. For the most recent version of any documentation, refer to:

www.bannerengineering.com.