

K30 Pro Optical Sensor Instruction Manual

Instruction Manual

30 mm Programmable Multicolor RGB Optical Sensor and Indicator

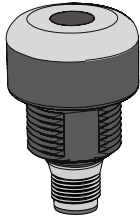

- Programmable using Banner's Pro Editor software and Pro Converter Cable
- Up to 7 colors in one device (14 colors using Pro Editor)
- Devices are completely self-contained—no controller needed
- Teachable modes with color feedback for ease of use
- Touchless activation removes the need for physical force to activate
- Rated IP65
- 10 V DC to 30 V DC operation
- Resistant to ambient light, EMI, and RFI interference
- Sensing and indication in one device



WARNING

DO NOT USE THIS DEVICE FOR PERSONNEL PROTECTION

Using this device for personnel protection could result in serious injury or death.

- This device does not include the self-checking redundant circuitry necessary to allow its use in personnel safety applications. A device failure or malfunction can cause either an energized (on) or de-energized (off) output condition.

Models

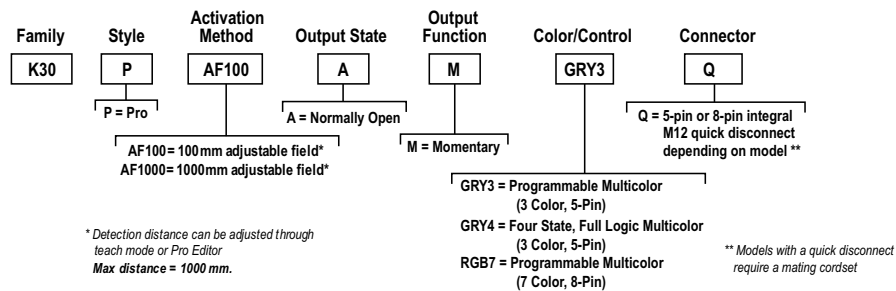

Overview

The K30 Pro Optical Sensor is an adjustable field optical sensor that can detect a wide variety of materials and objects.

Configure the sensor using software or remote input wires to sense objects up to a specific distance, ignoring objects beyond this distance (background suppression), or within a windowed range.

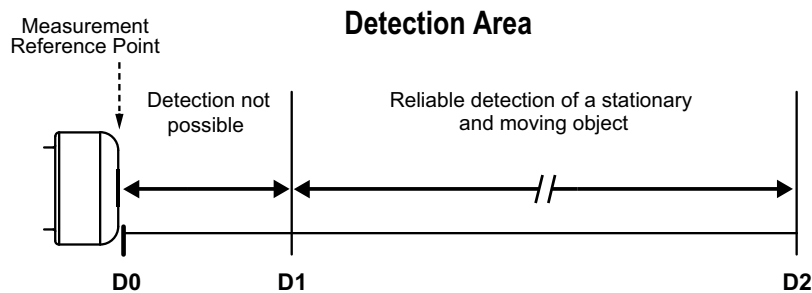

Model	D0 (mm)	Switch Point D1 (mm)	Switch Point D2 (mm)
K30PAF1000	0	20	1000

Pro Editor

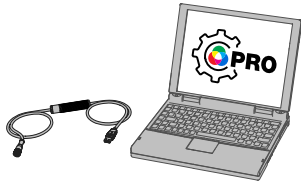

Use Banner's Pro Editor software and Pro Converter Cable to create custom configurations by selecting different colors, flash patterns, and animations.
For more information visit www.bannerengineering.com/proeditor.

Wiring Diagrams

Table 1: GRY3 Models

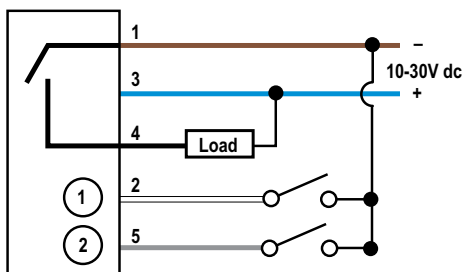

Figure 1: NPN

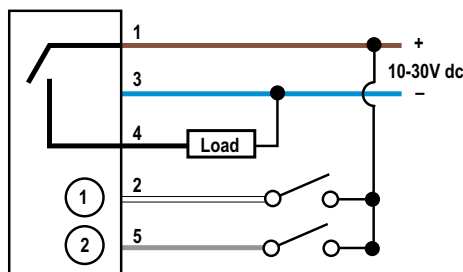

Figure 2: PNP

Pin 1 = Brown
Pin 2 = White
Pin 3 = Blue
Pin 4 = Black
Pin 5 = Gray (Remote Input)

Table 2: GRY3 Multicolor Color/Function Definition

	Green	Yellow	Red
Input 1	X	X	
Input 2		X	X

Table 3: GRY4 Models

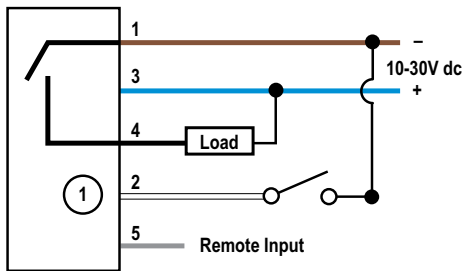

Figure 3: NPN

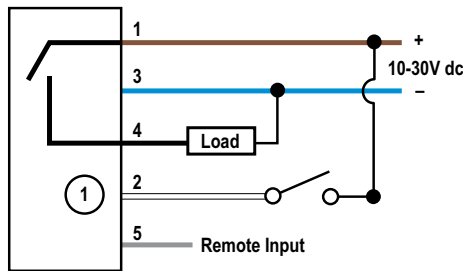

Figure 4: PNP

Pin 1 = Brown
Pin 2 = White
Pin 3 = Blue
Pin 4 = Black
Pin 5 = Gray (Remote Input)

Table 4: GRY4 Four State Full Logic

	No Detection	Detection
No Input	State 1: Indicator Off	State 3: Indicator Red
Input 1	State 2: Indicator Green	State 4: Indicator Yellow

Table 5:RGB Models

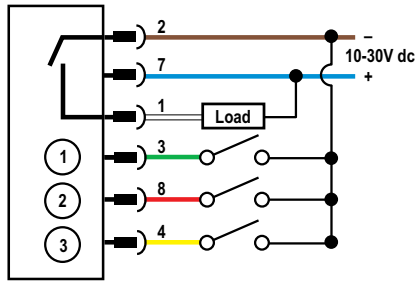

Figure 5: NPN

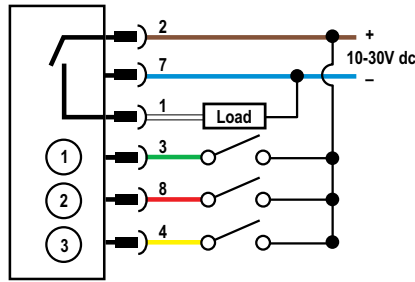

Figure 6: PNP

Pin 1 = White
 Pin 2 = Brown
 Pin 3 = Green
 Pin 4 = Yellow (Remote Input)
 Pin 5 = Not used
 Pin 6 = Not used
 Pin 7 = Blue
 Pin 8 = Red

Table 6:RGB Multicolor Color/Function Definition

	Red	Yellow	Green	Cyan	Blue	Magenta	White
Input 1	X	X				X	X
Input 2		X	X	X			X
Input 3				X	X	X	X

Configuring a Sensor

The K30 Pro Optical Sensor has three Teach modes. These modes are indicated with a Teach Status color.

The Signal Level color flashes in between the Teach Status color. The color of the Signal Level depends on the signal strength of the target:

- Green: Best signal, accepts Teach
- Yellow: Acceptable signal, can accept Teach
- Red: Poor signal, rejects Teach

Remote Input

Use the remote input to program the sensor remotely.

The remote input provides limited programming options and is Active High in PNP mode (V+ to brown wire), or Active Low in NPN mode (V+ to blue wire). For Active High, pulse the gray or yellow input wire to V+ (10 V DC to 30 V DC). For Active Low, pulse the gray or yellow input wire to ground (0 V DC).

The remote input wire is enabled by default. Pulse the remote input wire 7 times or use the Banner Pro Editor software to enable or disable the feature. When the remote input feature is enabled, pulse the remote input according to the diagram and the instructions provided in this manual. Remote teach can also be performed using the button on the Pro Converter Cable.

The length of the individual programming pulses is equal to the value T: $0.04 \text{ seconds} \leq T \leq 0.8 \text{ seconds}$.

Exit remote programming modes by cycling power or by waiting for 30 seconds.

NOTE: If a factory reset is performed through the Banner Pro Editor Software, the remote input wire becomes enabled (factory default setting). If the sensor is returned to factory defaults by using the remote input wire, the input wire remains enabled and the rest of the settings are restored to factory defaults.

Remote Teach

Use the following procedure to teach the Set Point.

1. Pulse the remote input:
 - 3x - Object Teach: The indicator alternates between a blue Teach Status color and the Signal Level color.
 - 4x - Background Teach: The indicator alternates between a magenta Teach Status color and the Signal Level color.
 - 5x - Window Teach: The indicator alternates between a cyan Teach Status color and the Signal Level color.
2. Present the Set Point.
3. Teach the Set Point.

Action	Result
Single pulse the remote input. 	Teach Accepted The indicator stops flashing and the device returns to operation. Teach Not Accepted The Signal Level color turns red during the teach procedure, and then the indicator stops flashing. Retry teaching the set point.

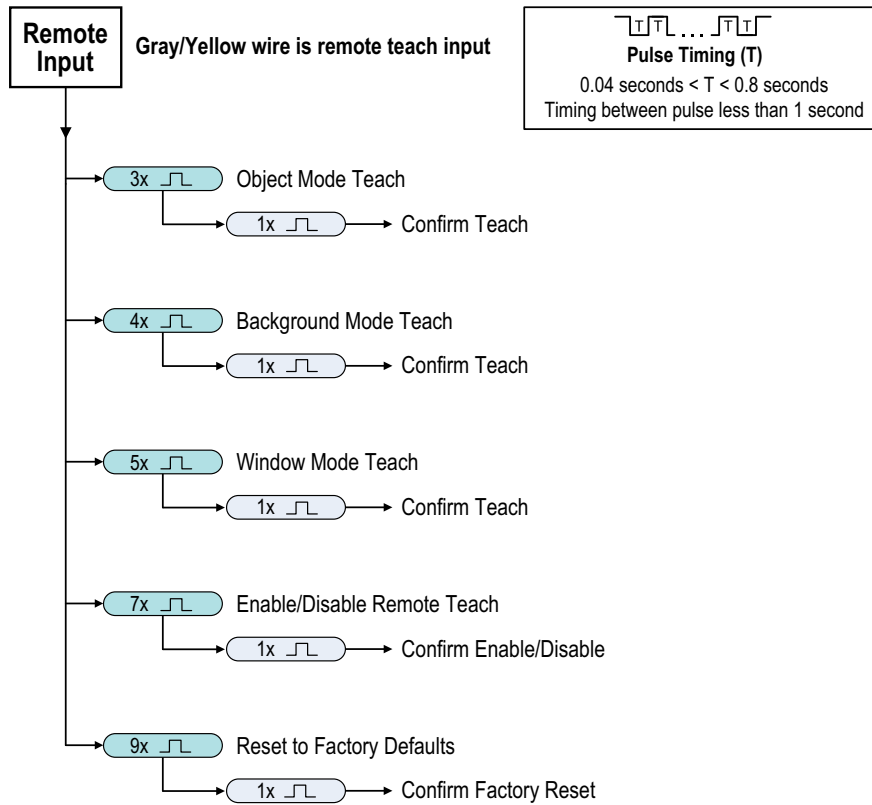

Figure 7: Remote Input Map

Teach Modes and Operation

Object Mode (default)

Teach Status Color: Blue

The K30 Pro Optical Sensor is configured to Object Mode by default. Object Mode sets the total Detection Area from the sensor to the Set Point plus the Offset Value (50 mm default). Use Object Mode to trigger a change in state when an object is present between the sensor minimum (20 mm default) and the taught distance plus the offset.

Three-pulse the remote input to enable Object Mode. Successfully entering Object Mode causes the device to alternate between the Teach Status color (Blue) and the Signal Level color.

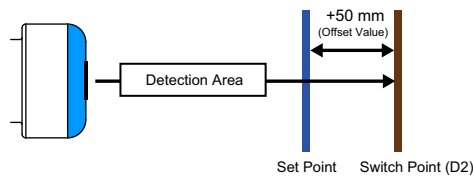

Background Mode

Teach Status Color: Magenta

Background Mode sets the total Detection Area from the sensor to the Set Point minus the Offset Value (50 mm default). Use Background Mode when there is a constant background object present and a state change is desired when another object is in front of that background.

Four-pulse the remote input to enable Background Mode. Successfully entering Background Mode causes the device to alternate between the Teach Status color (Magenta) and the Signal Level color.

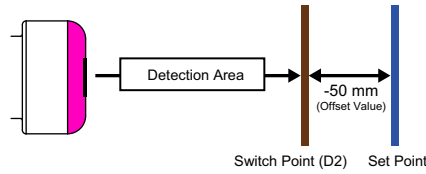

Window Mode

Teach Status Color: Cyan

Window Mode centers the total Detection Area at the Set Point plus and minus the Offset Value (50 mm default). Configuring a window near the minimum and maximum ranges shifts this window to ensure that it maintains this value. Use Window Mode when a change in state is desired within a specific narrow area, and not when outside this area.

Five-pulse the remote input to enable Window Mode. Successfully entering Window Mode causes the device to alternate between the Teach Status color (Cyan) and the Signal Level color.

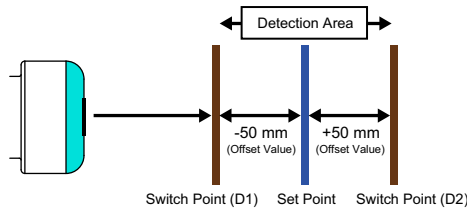

Reset the Sensor to Factory Defaults

Reset the sensor to factory default settings using one of two methods.

NOTE: If a factory reset is performed through the Banner Pro Editor Software, the remote input wire becomes disabled (factory default setting). If the sensor is returned to factory defaults by using the remote input wire, the input wire remains enabled and the rest of the settings are restored to factory defaults.

Reset Using the Banner Pro Editor Software

Go to **Sensor > Factory Reset**. The sensor indicators flash once, the sensor is reset back to the factory default settings, and a confirmation message displays.

Reset Using the Remote Input

Nine-pulse the remote input to reset the device to factory default settings. The device then flashes white on success. Pulse the remote input once more to apply the factory defaults.



Factory Default Settings via Remote Teach Mode

Table 7: Default Settings

Setting	Factory Default
Discrete Output and Remote Input	Bimodal
Remote Input Wire	Enabled
Offset	50 mm (2 in)
Operation Mode	Object Mode
D1	20 mm
D2	Model specific
NO/NC	Normally open
On Delay	0 ms
Off Delay	0 ms

Alternate Modes Available

The K30 Pro Optical Sensor has alternate modes available for use, which are configurable with Pro Editor.

These modes are ideal for applications where more informative indication based on object distance is desired. The sensing range can be used to trigger a discrete output, and also to vary an animation state to provide another level of feedback about a system.

Distance Mode

Distance Mode sets the device to operate as a gauge, which allows the user to configure a background color and a fill color to display how far an object is within the Detection Area.

As an object moves along the sensing range, the proportion of fill color to background color changes in a clockwise (CW) or counter-clockwise (CCW) direction. The proportion of fill color increases as an object approaches the maximum range, and decreases as it moves towards the minimum.

Coarse Distance Mode

Coarse Distance Mode allows the user to divide the Detection Area into custom zones to generate a unique animation when an object is present within that zone distance.

Configure up to six zones for animation and output state. The minimum zone distance is 50 mm.

Specifications

Supply Voltage (Vcc)

10 V DC to 30 V DC

Supply Current

110 mA maximum current at 30 V DC (exclusive of load)
30 mA typical current at 24 V DC (exclusive of load)

Supply Protection Circuitry

Protected against output short-circuit

Leakage Current Immunity

400 μ A

Range

The sensor can detect an object at the following ranges, depending on the material and size of the target: 20 mm to 1000 mm

Output Ratings

Maximum Load: 150 mA

ON-State Saturation Voltage:

< 2 V DC at 10 mA
< 2.5 V DC at 150 mA

OFF-State Leakage Current: < 10 μ A at 30 V DC

Remote Input

Allowable Input Voltage Range: 0 to Vsupply

Active High (internal weak pull-down): High state > (Vsupply - 2.25 V) at 2 mA maximum

Active Low (internal weak pull-up): Low state < 2.25 V at 2 mA maximum

Delay at Power-up

< 1 s

Response Time

Switching frequency: 4 Hz

Discrete output response: 120 ms

Repeatability

5 mm from 20 to 300 mm

8 mm from 300 mm to 600 mm

14 mm from 600 mm to 1000 mm

Temperature Effect

< \pm 5 mm from -20 °C to +50 °C (-4 °F to +122 °F)

Application Note

For the most accurate measurements, allow 5 minutes for the sensor to warm up

Mounting

M22 \times 1.5 threaded base, maximum torque 4.5 N·m (40 in·lbf)

Construction

Base, Dome, and Nut: Polycarbonate

Connections

Integral 5-pin or 8-pin M12 male quick-disconnect connector

Models with a quick disconnect require a mating cordset

NOTE: A shielded cable is required if the sensor is mounted outdoors or if the cable is longer than 30 m (98.4 ft).

Vibration and Mechanical Shock

All models meet MIL-STD-202F, Method 201A (Vibration: 10 Hz to 60 Hz maximum, 0.06 inch (1.52 mm) double amplitude, 10G acceleration) requirements. Method 213B conditions H&I. Shock: 75G with device operating; 100G for non-operation

Operating Temperature

-20 °C to +50 °C (-4 °F to +122 °F)

Storage Temperature

-40 °C to +70 °C (-40 °F to +158 °F)

Sensing Beam

Infrared, 940 nm

Environmental Rating

IP65

Pro Editor Configuration

Connection to Pro Editor software enables control of:

- **Animation:** Steady, Flash, Two Color Flash, 50/50, 50/50 Rotate, Chase, Intensity Sweep, Color Sweep, Wave, Double Wave
- **Color:** Green, Red, Yellow, Blue, White, Cyan, Magenta, Amber, Rose, Lime Green, Orange, Sky Blue, Violet, Spring Green
- **Intensity:** Low, Medium, High
- **Speed:** Slow, Standard, Fast
- **Output State:** Normally Open, Normally Closed, Momentary, Latching, On Delay, Off Delay
- **Logic Type:** Three State Advanced Control (F2 Mode), Seven State Advanced Control (F2 Mode), Four State Full Logic (Custom)

Pro Converter Cable required to interface between PC and indicator, see accessories

Default Indicator Characteristics

Color	Dominant Wavelength (nm) or Color Temperature (CCT)	Color Coordinates ^a		Lumen Output (Typical at 25 °C)
		x	y	
Green	522	0.154	0.700	5.8
Red	620	0.689	0.309	3.2
Yellow	576	0.467	0.463	7.9
Blue	466	0.140	0.054	1.3

Color	Dominant Wavelength (nm) or Color Temperature (CCT)	Color Coordinates ^a		Lumen Output (Typical at 25 °C)
		x	y	
White	5700K	0.328	0.337	8.8
Cyan	493	0.157	0.331	6.5
Magenta	–	0.392	0.186	3.9
Amber	589	0.556	0.420	5.5
Rose	–	0.525	0.237	3.5
Lime Green	562	0.383	0.523	8
Sky Blue	486	0.145	0.240	6.9
Orange	599	0.616	0.370	4.3
Violet	–	0.224	0.099	3.4
Spring Green	508	0.155	0.524	6.1

a. Refer to the CIE 1931 (x,y) Chromaticity Diagram to show equivalent color with indicated color coordinates. Actual coordinates may differ ± 5%.

Required Overcurrent Protection

WARNING: Electrical connections must be made by qualified personnel in accordance with local and national electrical codes and regulations.

Overcurrent protection is required to be provided by end product application per the supplied table.
 Overcurrent protection may be provided with external fusing or via Current Limiting, Class 2 Power Supply.
 Supply wiring leads < 24 AWG shall not be spliced.
 For additional product support, go to www.bannerengineering.com.

Supply Wiring (AWG)	Required Overcurrent Protection (A)	Supply Wiring (AWG)	Required Overcurrent Protection (A)
20	5.0	26	1.0
22	3.0	28	0.8
24	1.0	30	0.5

Certifications



Banner Engineering BV Park Lane, Culliganlaan 2F bus 3, 1831 Diegem, BELGIUM



Turck Banner LTD Blenheim House, Blenheim Court, Wickford, Essex SS11 8YT, Great Britain



Dimensions

All measurements are listed in millimeters [inches], unless noted otherwise.

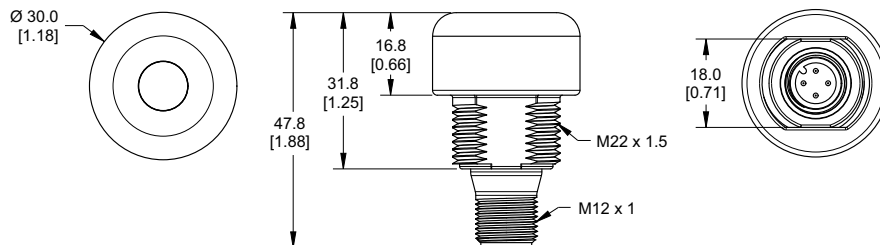

Beam Pattern

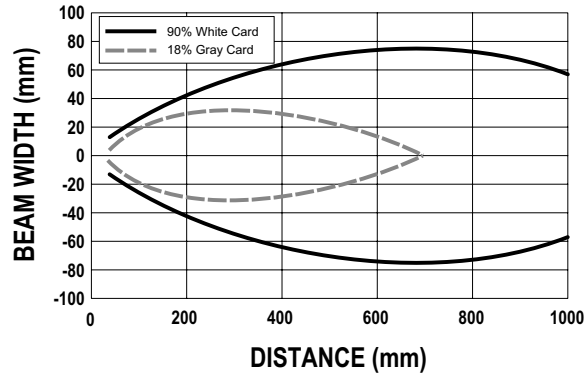

Figure 8: Typical beam pattern, in millimeters

Accessories

Pro Editor Hardware

PRO-KIT

Includes:

- Pro Converter Cable (MQDC-506-USB)
- Splitter (CSB-M1251FM1251M)
- Power Supply (PSW-24-1)

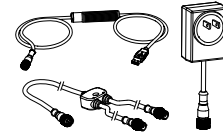

MQDC-506-USB

- Pro Converter Cable
- 1.83 m (6 ft) length 5-pin M12 quick disconnect to Device and USB to PC
- Required for connection to Pro Editor

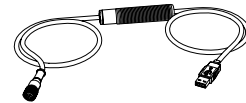

CSB-M1251FM1251M

- 5-pin parallel Y splitter (Male-Male-Female)
- For full Pro Editor preview capability
- Requires external power supply, sold separately

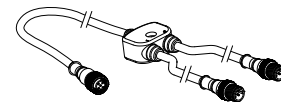

PSW-24-1

- 24 V DC, 1 A power supply
- 2 m (6.5 ft) PVC cable with M12 quick disconnect
- Provides external power with splitter cable, sold separately



ACC-PRO-CABLE5

- Mating accessory for cabled and terminal models
- 150 mm (6 inch) PVC cable with M12 quick disconnect
- Lever wire nuts included (qty 5)
- Required to connect cabled models and screw terminal models to Pro Converter Cable, sold separately

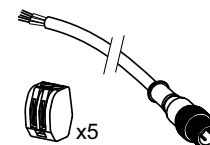

MQDC-801-5M-PRO

- 8-pin to 5-pin double-ended cordset
- 0.31 m (1 ft) PVC cable with M12 quick disconnects
- Required to connect 8-pin Pro Series-enabled devices to Pro Converter Cable (MQDC-506-USB), sold separately



Cordsets for the K30 Pro Optical

Not all models are shown. Please contact Banner for other available lengths and for double-ended cordsets.

5-Pin Threaded M12 Cordsets—Single Ended

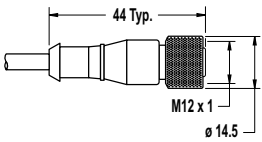
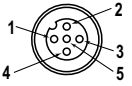
Model	Length	Style	Dimensions	Pinout (Female)
MQDC1-501.5	0.5 m (1.5 ft)	Straight		 <p>1 = Brown 2 = White 3 = Blue 4 = Black 5 = Gray</p>
MQDC1-503	0.9 m (2.9 ft)			
MQDC1-506	2 m (6.5 ft)			
MQDC1-515	5 m (16.4 ft)			
MQDC1-530	9 m (29.5 ft)			
MQDC1-560	18 m (59 ft)			
MQDC1-5100	31 m (101.7 ft)			

5-Pin Threaded M12 Cordsets—Single Ended

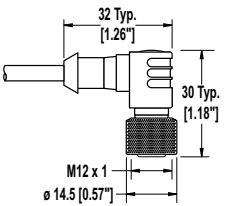
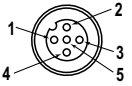
Model	Style	Length	Dimensions	Pinout (Female)
MQDC1-506RA	2 m (6.5 ft)	Right-Angle		 <p>1 = Brown 2 = White 3 = Blue 4 = Black 5 = Gray</p>
MQDC1-515RA	5 m (16.4 ft)			
MQDC1-530RA	9 m (29.5 ft)			
MQDC1-560RA	19 m (62.3 ft)			

8-Pin Threaded M12 Cordsets—Single Ended

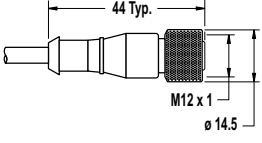
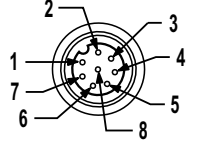
Model	Length	Style	Dimension	Pinout (Female)
MQDC1-803	1 m (3.2 ft)	Straight		 <p>1 = White 2 = Brown 3 = Green 4 = Yellow 5 = Gray 6 = Pink 7 = Blue 8 = Red</p>
MQDC1-806	2 m (6.5 ft)			
MQDC1-815	5 m (16.4 ft)			
MQDC1-830	9 m (29.5 ft)			
MQDC1-850	15 m (49.2 ft)			

8-Pin Threaded M12 Cordsets—Single Ended

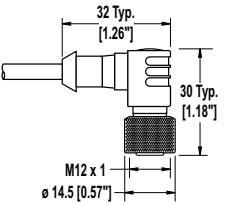
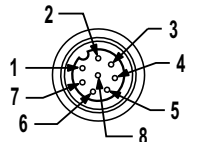
Model	Length	Style	Dimension	Pinout (Female)
MQDC1-806RA	2 m (6.5 ft)	Right-Angle		 <p>1 = White 2 = Brown 3 = Green 4 = Yellow 5 = Gray 6 = Pink 7 = Blue 8 = Red</p>
MQDC1-815RA	5 m (16.4 ft)			
MQDC1-830RA	9 m (29.5 ft)			
MQDC1-850RA	15 m (49.2 ft)			

Brackets

SMB22A

- Right-angle bracket with curved slot for versatile orientation
- 12-ga. stainless steel
- Mounting hole for 22 mm sensor

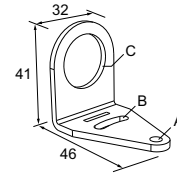

Hole center spacing: A to B = 26.0

Hole size: A = \varnothing 4.6, B = 4.6 x 16.9, C = 22.2

SMB22FVK

- V-clamp, flat bracket and fasteners for mounting to pipe or extensions
- Clamp accommodates 28 mm diameter tubing or 1 in. square extrusions
- 22 mm hole for mounting sensor

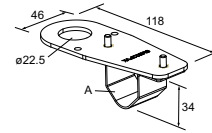

Hole size: A = \varnothing 22.5

SMB22RAVK

- V-clamp, right-angle bracket and fasteners for mounting to pipe or extensions
- Clamp accommodates 28 mm diameter tubing or 1 in. square extrusions
- 22 mm hole for mounting sensor

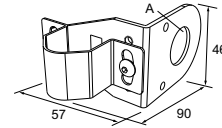

Hole size: A = \varnothing 22.5

SMBAMS22P

- Flat SMBAMS series bracket with 22 mm hole for mounting sensors
- Articulation slots for 90+° rotation
- 12-ga. (2.6 mm) cold-rolled steel

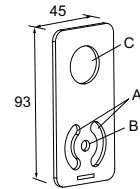

Hole center spacing: A = 26.0, A to B = 13.0

Hole size: A = 26.8 x 7.0, B = \varnothing 6.5, C = \varnothing 22.5

SMBAMS22RA

- Right-angle SMBAMS series bracket with 22 mm hole for mounting sensors
- Articulation slots for 90+° rotation
- 12-ga. (2.6 mm) cold-rolled steel

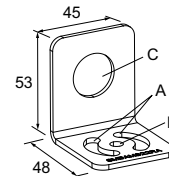

Hole center spacing: A = 26.0, A to B = 13.0

Hole size: A = 26.8 x 7.0, B = \varnothing 6.5, C = \varnothing 22.5

LMB22LPC

- For 28 mm tubular racking
- Toolless mount to racking
- 22 mm mounting hole

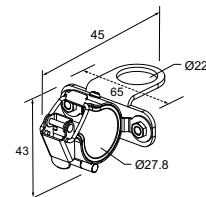

Banner Engineering Corp Limited Warranty

Banner Engineering Corp. warrants its products to be free from defects in material and workmanship for one year following the date of shipment. Banner Engineering Corp. will repair or replace, free of charge, any product of its manufacture which, at the time it is returned to the factory, is found to have been defective during the warranty period. This warranty does not cover damage or liability for misuse, abuse, or the improper application or installation of the Banner product.

THIS LIMITED WARRANTY IS EXCLUSIVE AND IN LIEU OF ALL OTHER WARRANTIES WHETHER EXPRESS OR IMPLIED (INCLUDING, WITHOUT LIMITATION, ANY WARRANTY OF MERCHANTABILITY OR FITNESS FOR A PARTICULAR PURPOSE), AND WHETHER ARISING UNDER COURSE OF PERFORMANCE, COURSE OF DEALING OR TRADE USAGE.

This Warranty is exclusive and limited to repair or, at the discretion of Banner Engineering Corp., replacement. **IN NO EVENT SHALL BANNER ENGINEERING CORP. BE LIABLE TO BUYER OR ANY OTHER PERSON OR ENTITY FOR ANY EXTRA COSTS, EXPENSES, LOSSES, LOSS OF PROFITS, OR ANY INCIDENTAL, CONSEQUENTIAL OR SPECIAL DAMAGES RESULTING FROM ANY PRODUCT DEFECT OR FROM THE USE OR INABILITY TO USE THE PRODUCT, WHETHER ARISING IN CONTRACT OR WARRANTY, STATUTE, TORT, STRICT LIABILITY, NEGLIGENCE, OR OTHERWISE.**

Banner Engineering Corp. reserves the right to change, modify or improve the design of the product without assuming any obligations or liabilities relating to any product previously manufactured by Banner Engineering Corp. Any misuse, abuse, or improper application or installation of this product or use of the product for personal protection applications when the product is identified as not intended for such purposes will void the product warranty. Any modifications to this product without prior express approval by Banner Engineering Corp will void the product warranties. All specifications published in this document are subject to change; Banner reserves the right to modify product specifications or update documentation at any time. Specifications and product information in English supersede that which is provided in any other language. For the most recent version of any documentation, refer to: www.bannerengineering.com.

For patent information, see www.bannerengineering.com/patents.

FCC Part 15 Class B

This equipment has been tested and found to comply with the limits for a Class B digital device, pursuant to part 15 of the FCC Rules. These limits are designed to provide reasonable protection against harmful interference in a residential installation. This equipment generates, uses and can radiate radio frequency energy and, if not installed and used in accordance with the instructions, may cause harmful interference to radio communications. However, there is no guarantee that interference will not occur in a particular installation. If this equipment does cause harmful interference to radio or television reception, which can be determined by turning the equipment off and on, the user is encouraged to try to correct the interference by one or more of the following measures:

- Reorient or relocate the receiving antenna.
- Increase the separation between the equipment and receiver.
- Connect the equipment into an outlet on a circuit different from that to which the receiver is connected.
- Consult the dealer or an experienced radio/TV technician for help.

Industry Canada

This device complies with CAN ICES-3 (B)/NMB-3(B). Operation is subject to the following two conditions: 1) This device may not cause harmful interference; and 2) This device must accept any interference received, including interference that may cause undesired operation.

Cet appareil est conforme à la norme NMB-3(B). Le fonctionnement est soumis aux deux conditions suivantes : (1) ce dispositif ne peut pas occasionner d'interférences, et (2) il doit tolérer toute interférence, y compris celles susceptibles de provoquer un fonctionnement non souhaité du dispositif.

Document title: K30 Pro Optical Instruction Manual
Part number: 231384
Revision: B
Original Instructions
© Banner Engineering Corp. All rights reserved.

