

Temposonics®

Magnetostrictive Linear Position Sensors

MH-Series Flexible MH Data Sheet

- Linear, absolute measurement
- Easy in-field installation and replacement
- Stroke lengths from 500...5000 mm
- Resolution: ± 0.2 mm
- Analog and CANbus output options

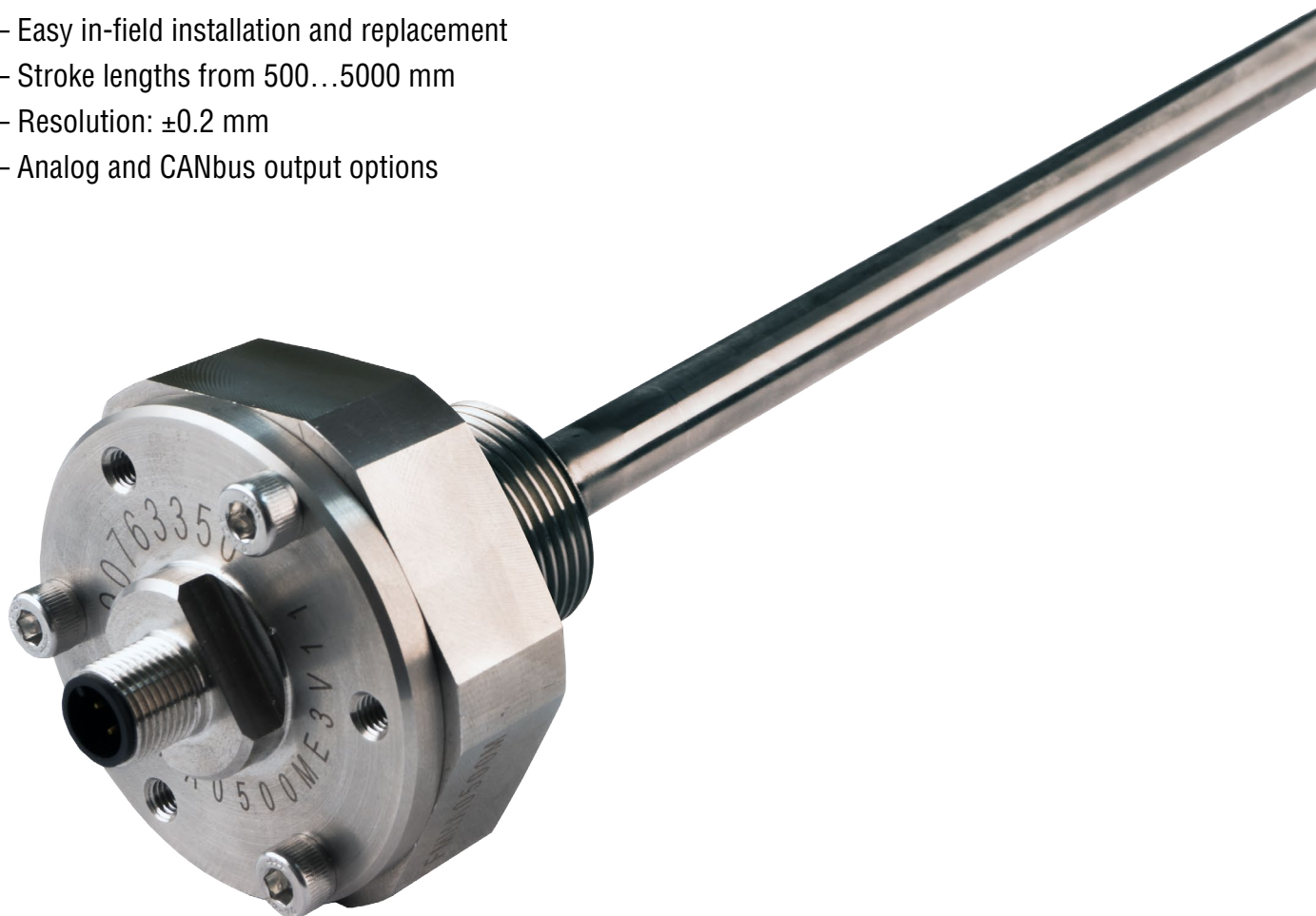

MEASURING TECHNOLOGY

The absolute, linear position sensors provided by MTS Sensors rely on the company's proprietary Temposonics® magnetostrictive technology, which can determine position with a high level of precision and robustness. Each Temposonics® position sensor consists of a ferromagnetic waveguide, a position magnet, a strain pulse converter and supporting electronics. The magnet, connected to the object in motion in the application, generates a magnetic field at its location on the waveguide.

A short current pulse is applied to the waveguide. This creates a momentary radial magnetic field and torsional strain on the waveguide. The momentary interaction of the magnetic fields releases a torsional strain pulse that propagates the length of the waveguide. When the ultrasonic wave reaches the end of the waveguide it is converted into an electrical signal. Since the speed of the ultrasonic wave in the waveguide is precisely known, the time required to receive the return signal can be converted into a linear position measurement with both high accuracy and repeatability.

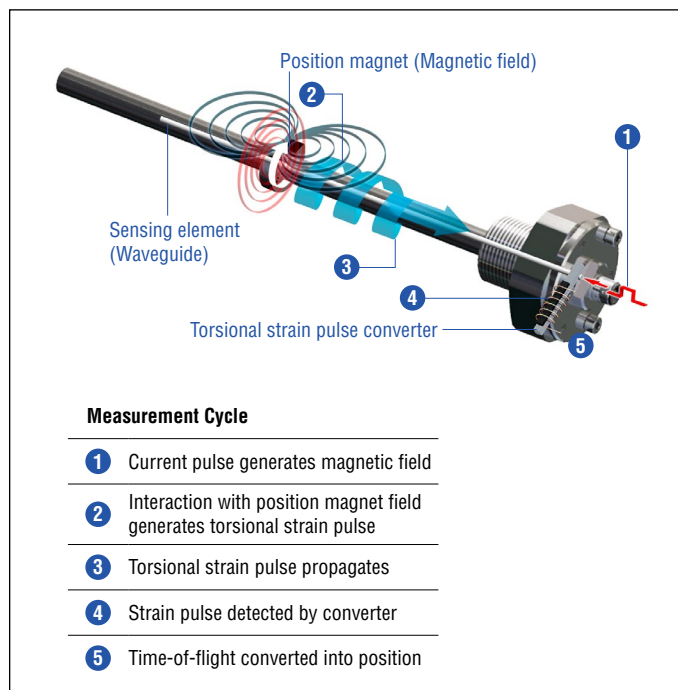

Fig. 1: Time-of-flight based magnetostrictive position sensing principle

FLEXIBLE MH SENSOR

Designed for use with hydraulic cylinders in mobile applications, the externally threaded Flexible MH sensor features an innovative two-part design. This design allows users to separate the flexible sensing element and electronics from the housing without opening the hydraulic system.

While it is manageable to install and remove hydraulic cylinder sensors at a manufacturing facility, it can be extremely challenging in the field. Trained service technicians can remove and replace the internal components with just 200 mm of clearance regardless of stroke length and without breaking the hydraulic seal. This serviceability means decreased downtime and disruption, providing increased productivity. Replacement units ship as coiled rings to ease handling and reduce shipping costs.

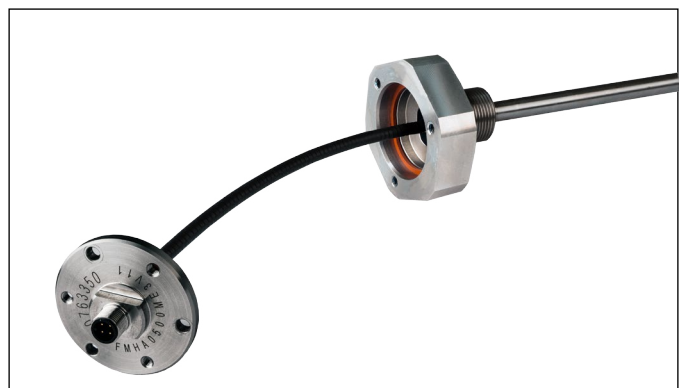

Fig. 2: Two-part housing design

TECHNICAL DATA ANALOG

Input		
Measured value	Position	
Stroke range	500...5000 mm (in 20 mm steps)	
Output		
Signal characteristic	Analog output restricted by noise or A/D converter of control unit	
Voltage	0.25...4.75 VDC / 0.5...4.5 VDC	
Current	4...20 mA	
Resolution	±0.2 mm	
Sample rate	2 ms	
Accuracy		
Linearity	±0.04 % (F.S.)	
Repeatability	±0.005 % (F.S.)	
Hysteresis	±0.2 mm	
Operating conditions		
Mounting position	Any	
Operating temperature	-40...+105 °C	
Humidity	90 % rel. humidity, no condensation	
Ingress protection	IP67 / IP69K with appropriate mating connection	
Pressure		
Nominal operating pressure (P _N)	350 bar	
Max. overload pressure in cylinder (P _{MAX})	450 bar	
Max. static proof pressure in cylinder (P _{PROOF})	625 bar	
Environmental testing		
Shock test	IEC 60068-2-27, 100 g (6 ms) single shock, 50 g (11 ms) at 1000 shocks per axis	
Vibration test	IEC 60068-2-64, 2 g (5...2000 Hz)	
EMC test & evaluation	ISO16750-2:2010 ISO 14982:2009 - Agricultural and forestry machinery ISO 13766:2006 - Earth-moving machinery EN 13309:2010 - Construction machinery RF immunity to 200 V/m per ISO 11452-2/-4	
Materials and dimensions		
Sensor rod with flange	Stainless steel 1.4306 (AISI 304L)	
Sensor electronics housing	Stainless steel 1.4305 (AISI 303)	
Electrical installation		
Connector	M12 male plug	
Supply voltage	12 VDC (tolerance range 8...32 VDC)	24 VDC (tolerance range 8...32 VDC)
Current consumption	Typ. ≤ 100 mA	Typ. ≤ 50 mA
Load (output VDC)	R _L ≥ 10 kΩ	R _L ≥ 10 kΩ
Load current (output VDC)	Typ. 1 mA	Typ. 1 mA
Load (output mA)	R _L ≤ 250 Ω	R _L ≤ 500 Ω
Inrush current	Max. 2.5 A/2 ms	Max. 4.5 A/2 ms
Supply voltage ripple	< 1 % _{pp}	
Power drain	< 1 W	
Over voltage protection (GND-VDC)	Up to +36 VDC	
Polarity protection (GND-VDC)	Up to -36 VDC	
Insulation Resistance	R ≥ 10 MΩ @ 60 sec	
Electric strength	500 VDC (DC GND to chassis GND)	

TECHNICAL DATA DIGITAL

Input		
Measured value	Position	
Stroke range	500...5000 mm (in 20 mm steps)	
Output		
Signal characteristic	Analog output restricted by noise or A/D converter of control unit	
Interface	CANopen / SAE J1939	
Resolution	±0.2 mm	
Sample rate	CANopen: 1 ms; SAE J1939: 20 ms	
Accuracy		
Linearity	±0.04 % (F.S.)	
Repeatability	±0.005 % (F.S.)	
Hysteresis	±0.2 mm	
Operating conditions		
Mounting position	Any	
Operating temperature	-40...+105 °C	
Humidity	90 % rel. humidity, no condensation	
Ingress protection	IP67 / IP69K with appropriate mating connection	
Pressure		
Nominal operating pressure (P _N)	350 bar	
Max. overload pressure in cylinder (P _{MAX})	450 bar	
Max. static proof pressure in cylinder (P _{PROOF})	625 bar	
Environmental testing		
Shock test	IEC 60068-2-27, 100 g (6 ms) single shock, 50 g (11 ms) at 1000 shocks per axis	
Vibration test	IEC 60068-2-64, 2 g (5...2000 Hz)	
EMC test & evaluation	ISO16750-2:2010 ISO 14982:2009 - Agricultural and forestry machinery ISO 13766:2006 - Earth-moving machinery EN 13309:2010 - Construction machinery RF immunity to 200 V/m per ISO 11452-2/-4	
Materials and dimensions		
Sensor rod with flange	Stainless steel 1.4306 (AISI 304L)	
Sensor electronics housing	Stainless steel 1.4305 (AISI 303)	
Electrical installation		
Connector	M12 male plug	
Supply voltage	12 VDC (8...32 VDC)	24 VDC (8...32 VDC)
Current consumption	Typ. ≤ 100 mA	Typ. ≤ 50 mA
Inrush current	Max. 1.0 A @ 2 ms	Max. 1.5 A @ 2 ms
Bus termination (HI-LO)	120 Ω	
Supply voltage ripple	< 1 % p-p	
Power drain	< 1.5 W	
Over voltage protection (GND-VDC)	Up to +36 VDC	
Polarity protection (GND-VDC)	Up to -36 VDC	
Insulation Resistance	R ≥ 10 MΩ @ 60 sec.	
Electric strength	500 VDC (DC GND to chassis GND)	

TECHNICAL DRAWING

FMH with flat end plug

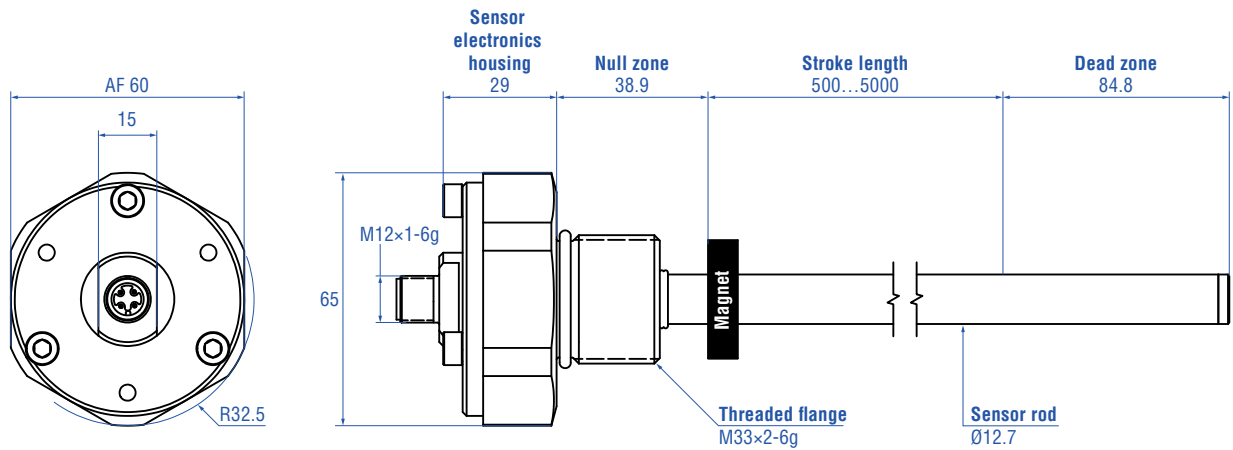

FMH with M4 female thread plug

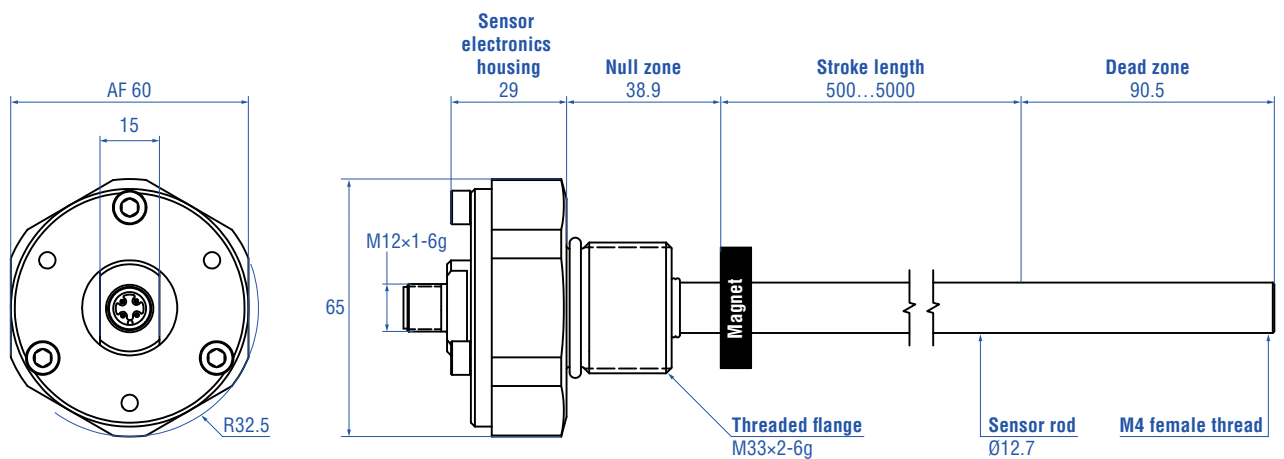

Controlling design dimensions are in millimeters
Unless otherwise stated, apply to the general tolerances according to DIN ISO 2768-m

CONNECTOR WIRING





Analog output

M12 connector		Pin	E	G	H
	1	not connected	VDC	VDC	
	2	VDC	not connected	SIG	
	3	GND	GND	GND	
	4	SIG	SIG	not connected	

Digital output

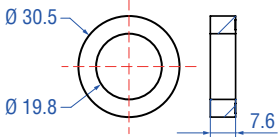
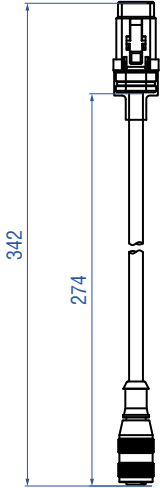
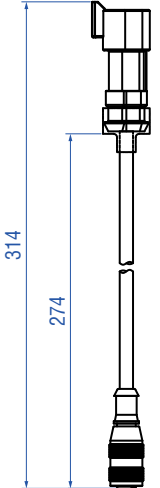
M12 connector		Pin	F
	1	not connected	
	2	VDC	
	3	GND	
	4	CAN_HI	
	5	CAN_LOW	

FREQUENTLY ORDERED ACCESSORIES

Position magnets	Cord sets and adapter cables	
		
<p>Ring magnet Part no. 402 316</p> <p>Material: PA ferrite coated Weight: ca. 13 g Operating temperature: -40...+100 °C Surface pressure: 20 N/mm²</p>	<p>4 pin M12 to DTM06 connector Part no. 254 597</p> <p>M12 connector: Brass/Nickel DT connector: DTM06 3 pin Material: PVC Jacket Cable length: 275 mm Cable Ø: 5 mm Operating temperature: -40...+105 °C</p>	<p>4 pin M12 to DT04 connector Part no. 254 600</p> <p>M12 connector: Brass/Nickel DT connector: DT04 3 pin Material: PVC Jacket Cable length: 275 mm Cable Ø: 5 mm Operating temperature: -40...+105 °C</p>
Test kits		
		
<p>MH test kit (analog) Part no. 280 618</p> <p>Kit includes:</p> <ul style="list-style-type: none"> • 12 VDC battery charger with adapter (EU & UK) • Cable with M12 connector • Cable with pigtailed wires • Carrying case 	<p>MH test kit (digital) for US Part no. 253 879</p> <ul style="list-style-type: none"> • USB CAN-Modul Kit: <ul style="list-style-type: none"> - USB CAN-Modul - USB CAN-Modul Utility CD (driver & manual) • USB cable • cable with MTS M12 connector and RS232 connector • cable with RS232 connector • carrying case • 12 VDC power supply 	<p>MH test kit (digital) for EU / Asia Part no. 254 267</p> <ul style="list-style-type: none"> • USB CAN-Modul Kit: <ul style="list-style-type: none"> - USB CAN-Modul - USB CAN-Modul Utility CD (driver & manual) • USB cable • cable with MTS M12 connector and RS232 connector • cable with RS232 connector • carrying case • 12 VDC power supply

Controlling design dimensions are in millimeters

ORDER CODE FMH ANALOG

1	2	3	4	5	6	7	8	9	10	11	12	13	14
F	M	H						M		3			
a			b	c					d	e	f		

a	Sensor model												
F	M	H	Flexible MH										

b	Design												
A	M33 thread flange, flat end plug												
B	M33 thread flange, M4 female plug												

c	Stroke length												
X	X	X	X	M	0500...5000 mm (20 mm increments)								

d	Pin assignment												
M12 connector (VDC - GND - SIG)													
E	M12 connector with 4 pins (E: 2-3-4)												
G	M12 connector with 4 pins (G: 1-3-4)												
H	M12 connector with 4 pins (H: 1-3-2)												

e	Operating voltage												
3	+12/24 VDC (8...32 VDC)												

f	Output												
V	1	1	0.25...4.75 VDC										
V	1	2	0.5...4.5 VDC										
V	1	3	4.75...0.25 VDC										
V	1	4	4.5...0.5 VDC										
A	0	1	4...20 mA										
A	0	4	20...4 mA										

DELIVERY



Position sensor,
O-ring

Accessories have to be ordered
separately.

Operation manuals & software are available at:
www.mtssensors.com

NOTICE

If you have questions about the replacement of sensor electronics and sensor element contact the MTS Sensors application team.

ORDER CODE FMH DIGITAL

1	2	3	4	5	6	7	8	9	10	11	12	13	14	15	16	17
F	M	H						M	F	3		0	1			
a			b	c					d	e	f			g	h	

a Sensor model

F	M	H	Flexible MH
---	---	---	-------------

b Design

A	M33 thread flange, flat end plug
B	M33 thread flange, M4 female plug

c Stroke length

X	X	X	X	M	0500...5000 mm (20 mm increments)
---	---	---	---	---	-----------------------------------

d Pin assignment

M12 connector (VDC - GND - CAN HI - CAN LO)

F	M12 connector with 5 pins (F: 2-3-4-5)
---	--

e Operating voltage

3	+12/24 VDC (8...32 VDC)
---	-------------------------

f Output

C	0	1	CANopen
J	0	1	SAE J1939

g Baud rate setting

CANopen

0	1000 kbit/s
1	800 kbit/s
2	500 kbit/s
3	250 kbit/s (default)
4	125 kbit/s

SAE J1939

3	250 kbit/s (fix setting)
---	--------------------------

h Node ID

CANopen

7	F	Node ID (hex): 01...7F (default = 7F)
---	---	---------------------------------------

SAE J1939

F	D	Node ID (hex): 01...FD (default = FD)
---	---	---------------------------------------

DELIVERY



Position sensor,
O-ring

Accessories have to be ordered
separately.

Operation manuals & software are available at:
www.mtssensors.com

NOTICE
If you have questions about the replacement of sensor electronics
and sensor element contact the MTS Sensors application team.

Document Part Number:
551847 Revision A (EN) 07/2016

LOCATIONS

USA
MTS Systems Corporation
Sensors Division
3001 Sheldon Drive
Cary, N.C. 27513, USA
Tel. +1 919 677-0100
Fax +1 919 677-0200
info.us@mtssensors.com
www.mtssensors.com

JAPAN
MTS Sensors Technology Corp.
737 Aihara-machi,
Machida-shi,
Tokyo 194-0211, Japan
Tel. +81 42 775-3838
Fax +81 42 775-5512
info.jp@mtssensors.com
www.mtssensors.com

FRANCE
MTS Systems SAS
Zone EUROPARC Bâtiment EXA 16
16/18, rue Eugène Dupuis
94046 Creteil, France
Tel. +33 1 58 4390-28
Fax +33 1 58 4390-03
info.fr@mtssensors.com
www.mtssensors.com

GERMANY
MTS Sensor Technologie
GmbH & Co. KG
Auf dem Schüffel 9
58513 Lüdenscheid, Germany
Tel. +49 2351 9587-0
Fax +49 2351 56491
info.de@mtssensors.com
www.mtssensors.com

CHINA
MTS Sensors
Room 504, Huajing Commercial Center,
No. 188, North Qinzhou Road
200233 Shanghai, China
Tel. +86 21 6485 5800
Fax +86 21 6495 6329
info.cn@mtssensors.com
www.mtssensors.com

ITALY
MTS Systems Srl
Sensor Division
Via Camillo Golgi, 5/7
25064 Gussago (BS), Italy
Tel. +39 030 988 3819
Fax +39 030 982 3359
info.it@mtssensors.com
www.mtssensors.com

LEGAL NOTICES

MTS, Temposonics and Level Plus are registered trademarks of MTS Systems Corporation in the United States; MTS SENSORS and the MTS SENSORS logo are trademarks of MTS Systems Corporation within the United States. These trademarks may be protected in other countries. All other trademarks are the property of their respective owners. Copyright © 2016 MTS Systems Corporation. No license of any intellectual property rights is granted. MTS reserves the right to change the information within this document, change product designs, or withdraw products from availability for purchase without notice. Typographic and graphics errors or omissions are unintentional and subject to correction. Visit www.mtssensors.com for the latest product information.

ISO 9001
CERTIFIED

