

MINI-BEAM® Clear Plastic Detection Sensors

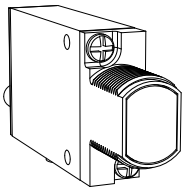

Datasheet

AC-operated or DC-operated Sensors for Clear Plastic Detection



- Senses the presence of clear plastic materials while ignoring all other materials
- A highly reliable, cost-saving alternative to ultrasonic sensors
- Applications include glass/plastic sorting and clear plastic web break detection



WARNING: Not To Be Used for Personnel Protection

Never use this device as a sensing device for personnel protection. Doing so could lead to serious injury or death. This device does not include the self-checking redundant circuitry necessary to allow its use in personnel safety applications. A sensor failure or malfunction can cause either an energized or de-energized sensor output condition.

Models

Model ¹	Range	Cable	Supply Voltage	LED	Output	Sensing Mode
SM31EPD	0.3 m	2 m (6.5 ft) 2-conductor integral cable	10 V to 30 V dc	Visible red	Bipolar NPN/PNP	
SM31RPD ²		2 m (6.5 ft) 4-conductor integral cable				
SMA31EPD	0.3 m	2 m (6.5 ft) 2-conductor integral cable	24 V to 240 V ac	Visible red	SPST Solid-state 2-Wire	
SM2A31RPD ³						

Overview

The Banner MINI-BEAM® Clear Plastic Detection System consists of a special emitter and receiver with a unique optical arrangement that actively detects the presence of clear plastic material in the beam. When clear plastic material is introduced, there is a dramatic increase in the intensity of the light which reaches the receiver. As a result, clear plastic is reliably detected and differentiated from all other materials.

The system uses a powerful modulated visible LED light source, which makes this sensing pair extremely forgiving of dirt buildup and misalignment. The high contrast ratio that results from this sensing method (10 to 1 contrast or more) eliminates the need for critical sensitivity adjustments.

These sensors detect most transparent plastics, whether clear or colored. However, there are a few materials that are not detected due to their molecular structure (some acrylics, for example). This fact makes it possible to sort between some different types of clear plastic materials. Evaluate material samples by sending them to Banner Engineering or through on-site testing by your local Banner sales engineer.

Common applications include those involving manufacture or reclamation of plastic bottles and processing of clear plastic webs. This system may also be used to inspect clear plastic containers for label, cap, or product presence. Because a light signal is established through a container only when there is a missing item, there is usually no need for an interrogation scheme.

Each sensor comes with a stainless steel right-angle mounting bracket and hardware. These sensors have the same rugged, epoxy-encapsulated design inherent in the entire MINI-BEAM sensor line.

¹ Integral 2 m (6.5 ft) unterminated cable models are listed.

- To order a quick-disconnect (QD) model, add suffix "QD" to the model number. For example, SM31EPDQD.
- Models with a quick disconnect require a mating cordset.

² Compatible only with DC emitter SM31EPD, due to response times.

³ Compatible with either the AC or DC emitter.



Installation

Mount and Align the Sensor

The following setup procedure assures reliable detection of clear plastic material:

1. Mount the brackets directly opposite of each other, using #8 (4 mm) bolts.
The brackets permit adjustment in only one plane. Mount the brackets to surfaces that are parallel to each other to within 2° and that are coplanar.

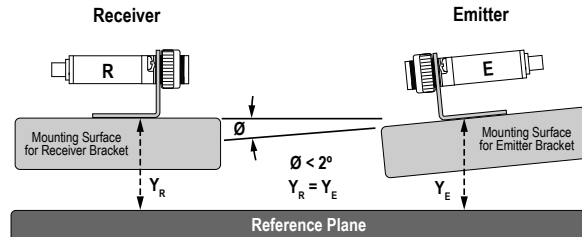

Figure 1. Coplanarity of Mounting Brackets

2. Install the emitter.
 - a) Install the emitter in either bracket using an 18 mm mounting nut and lock washer.
 - b) Place the lock washer between the bracket and the body of the emitter.
 - c) Position the body of the emitter either parallel or perpendicular to the length dimension of the plastic part or material to be detected.

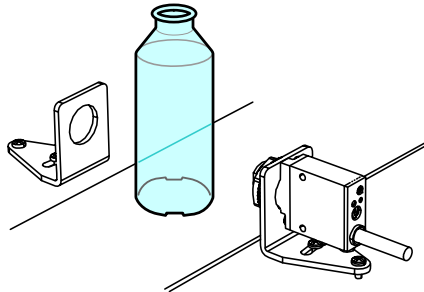

Figure 2. Emitter Position—Parallel

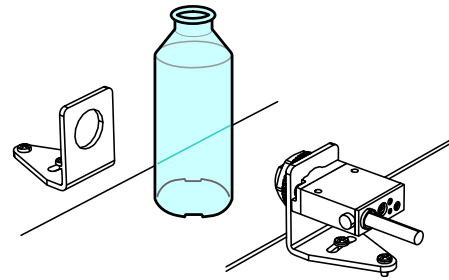

Figure 3. Emitter Position—Perpendicular

3. Install the receiver.
 - a) Install the receiver on the other bracket.
 - b) Tighten the mounting nut (finger tight only).
4. Connect power to both the emitter and receiver (see [Wiring Diagrams](#)).
Red light should be visible emanating from the emitter lens.

5. Align the emitter.
 - a) Remove the backing from the 1 inch square of adhesive-backed retroreflective tape included with the receiver, and save the plastic bag that came with the retroreflective tape.
 - b) Attach the retroreflective tape to the front of the receiver lens.
 - c) Loosen the #8 bolts which hold the emitter bracket to the mounting surface.
 - d) From behind the emitter, sight along the top or side of the emitter housing toward the receiver.
 - e) Adjust the emitter bracket until the red light image from the emitter is centered on the piece of retroreflective tape. This assures that the emitter is properly aligned to the receiver.
 - f) Tighten the #8 bolts.

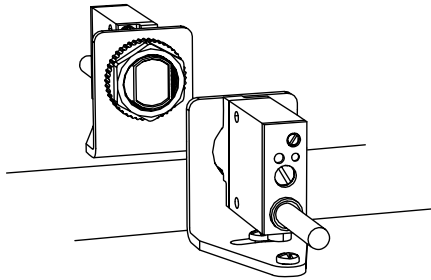

Figure 4. Emitter Alignment

6. Turn the sensitivity (GAIN) adjustment on the receiver fully clockwise.

The sensitivity adjustment is a 15-turn potentiometer with a slotted screw adjustment clutched at both ends of rotation. Turning the adjustment 15 or more full clockwise turns assures the maximum GAIN setting.

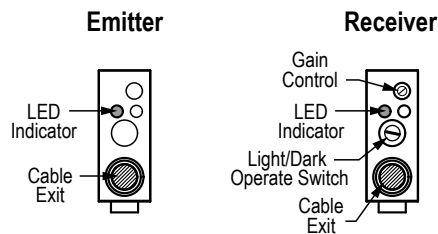

Figure 5. Sensor Indicators and Adjustments

7. Rotate the receiver, in the bracket, around the axis of the threaded barrel so that the body of the receiver is at about 45° to the body of the emitter.

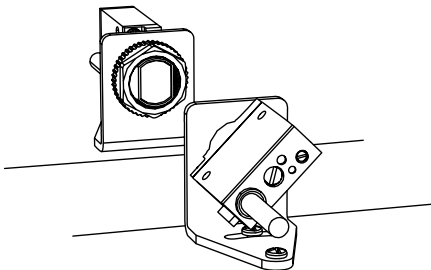

Figure 6. Rotate Receiver 45° to the Emitter

8. Rotate the Light/Dark operate switch on the receiver to the Light operate position.
9. Remove the retroreflective tape from the front of the receiver lens.
10. Verify that the alignment indicator on the back of the receiver turns on.

Receiver model SM31RPD has the Alignment Indicator Device (AID™) signal strength system which causes a rapid flickering of the alignment indicator LED. The fastest pulse rate of the LED indicates the best alignment of emitter to receiver.
11. Rotate the receiver so that the housing is parallel to the emitter housing.

The alignment indicator LED turns off.

12. Rotate the receiver in both directions from its parallel position and find the point midway between the two angles that cause the alignment indicator to turn on.
This is the correct position.

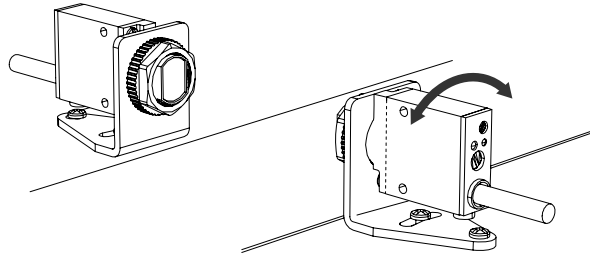
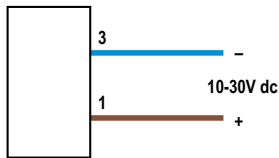

Figure 7. Final Alignment

13. Tighten the 18 mm nut on the receiver to complete the installation.
14. Test the system.
 - a) Place the plastic bag that contained the retroreflective tape between the emitter and receiver. The alignment indicator LED turns on.
 - b) Place the product to be sensed between the emitter and the receiver, and verify that the indicator LED lights and the output changes state when the clear plastic product is in the beam.

Wiring Diagrams

SM31EPD DC Emitter



SMA31EPD AC Emitter

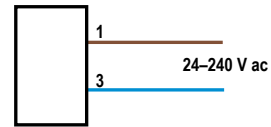

Note: Polarity must be observed.



Note: Wiring is without regard to wire color.

SM31RPD DC Receiver

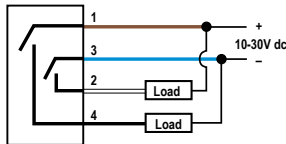

SM2A31RPD AC Receiver

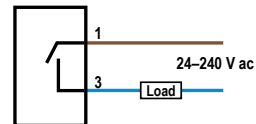

$$I_{\text{off}} = < 1.7 \text{ mA}$$



Note: Wiring is without regard to wire color.



Note:

1. The NPN output (white wire) of model SM31RPD interfaces directly as an input to Banner logic modules, including MICRO-AMP® and MAXI-AMP™ CL Series modules.
2. Off-State Leakage Current: Model SM2A31RPD remains powered when the load is off by a residual current which flows through the load. This off-state leakage current is always less than 1.7 mA. The effect of this leakage current depends upon the characteristics of the load. The voltage which appears across the load in the off-state is equal to the leakage current of the receiver multiplied by the resistance of the load: $V(\text{off}) = 1.7 \times R(\text{load})$.
3. The output of model SM2A31RPD will be damaged or destroyed if the load becomes a short circuit or draws excessive current.

Specifications

Specifications — DC Models SM31EPD & SM31RPD

Supply Voltage

10 V to 30 V dc (10% maximum ripple) at less than 25 mA (exclusive of load)

Receiver Output Configuration

Bipolar: One PNP and one NPN open-collector transistor

Receiver Output Rating

150 mA maximum each output at 25 °C, derated to 100 mA at 70 °C (derate approximately 1 mA per °C)

Output leakage: less than 1 microamp (off-state)

Output saturation voltage (PNP output): less than 1 V at 10 mA and less than 2 V at 150 mA load

Output saturation voltage (NPN output): less than 200 millivolts at 10 mA and less than 1 V at 150 mA load

Receiver Output Protection Circuitry

Protected against false pulse on power-up, inductive load transients, power supply polarity reversal, and continuous overload or short circuit of outputs

Receiver Response Time

The sensors respond to either a light or a dark signal of 1 millisecond or longer duration (independent of signal strength), 500 Hz maximum



Note: 100 ms delay on power-up; outputs do not conduct during this time.

Repeatability of Response

0.14 milliseconds, independent of signal strength

Range

0 m to 0.3 m (0 ft to 1 ft) minimum.

Actual range depends on the light-transmission properties of the clear plastic material being sensed

Connections

SM31EPD: PVC-jacketed 2-conductor cable

SM31RPD: PVC-jacketed 4-conductor cable

Standard length is 2 m (6 ft)

SM31EPDQD and SM31RPDQD: integral quick-disconnect (QD) connector; mating cables (required) must be ordered separately

Adjustments

SM31RPD has a Light/Dark operate select switch and a 15-turn slotted brass screw GAIN (sensitivity) adjustment potentiometer (clutched at both ends of travel)

Both controls are located on the rear panel of the sensor and are protected by the gasketed, clear acrylic cover

Indicators

Red LED on the rear of the emitter: ON means power to the sensor is ON
Red LED indicator located on the rear of the receiver: Banner's exclusive, patented Alignment Indicating Device (AID™, US patent #4356393) turns on whenever a light condition is sensed, with a superimposed pulse rate proportional to the light signal strength (the stronger the signal, the faster the pulse rate)

Construction

Sensor: Thermoplastic

Lens: Acrylic

Environmental Rating

Meets NEMA standards 1, 2, 3, 3S, 4, 4X, 6, and 12; IEC IP67

Operating Conditions

Temperature: -20 °C to +70 °C (-4 °F to +158 °F)

Humidity: 90% at +50 °C maximum relative humidity (non-condensing)

Application Notes

The NPN output of model SM31RPD is directly compatible as an input to Banner logic modules, including all non-amplified MICRO-AMP® modules and CL Series MAXI-AMP™ modules

Required Overcurrent Protection



WARNING: Electrical connections must be made by qualified personnel in accordance with local and national electrical codes and regulations.

Overcurrent protection is required to be provided by end product application per the supplied table. Overcurrent protection may be provided with external fusing or via Current Limiting, Class 2 Power Supply.

Supply wiring leads < 24 AWG shall not be spliced.

For additional product support, go to www.bannerengineering.com.

Supply Wiring (AWG)	Required Overcurrent Protection (Amps)
20	5.0
22	3.0
24	2.0
26	1.0
28	0.8
30	0.5

Certifications



Specifications — AC Models SMA31EPD & SM2A31RPD

Supply Voltage and Current

24 V to 240 V ac (50 Hz/60 Hz), 250 V ac maximum

Receiver Output Configuration

SPST SCR solid-state relay with either normally closed or normally open contact (selectable Light/Dark operate)

Receiver Output Rating

Minimum load current: 5 mA

Maximum steady-state load capability: 300 mA maximum at up to 50 °C ambient (122 °F), derated to 100 mA maximum at 70 °C (158 °F)

Inrush capability: 3 amps for 1 second or 10 amps for 1 cycle (non-repeating)

OFF-state leakage current: less than 1.7 mA rms

ON-state voltage drop: ≤ 5 volts at 300 mA, ≤ 10 volts at 15 mA load

Receiver Output Protection

Protected against false pulse on power-up and inductive load transients

Receiver Response Time

2 milliseconds ON and 1 millisecond OFF, independent of signal strength
Does not include load response time of up to 1/2 ac cycle (8.3 milliseconds)



Note: 300 ms delay on power-up; outputs do not conduct during this time.

Repeatability of Response

0.3 millisecond, independent of signal strength

Range

0 m to 0.3 m (0 ft to 1 ft) minimum. Actual range depends on the light-transmission properties of the clear plastic material being sensed.

Connections

PVC-jacketed 2-conductor cable. Standard length is 2 m (6 feet). Models SMA31EPDQD and SM2A31RPDQD have an integral quick-disconnect (QD) connector; mating cables (required) must be ordered separately

Adjustments

SM2A31RPD has a Light/Dark operate select switch and a 15-turn slotted brass screw GAIN (sensitivity) adjustment potentiometer (clutched at both ends of travel). Both controls are located on the rear panel of the sensor and are protected by a gasketed, clear acrylic cover.

Indicators

Red LED on the rear of the emitter: ON means power to the sensor is ON
Red LED on the rear of the receiver: ON when the output is energized

Construction

Sensor: Thermoplastic
Lens: Acrylic

Environmental Rating

Meets NEMA standards 1, 2, 3, 3S, 4, 4X, 6, 12, and 13; IEC IP67

Operating Conditions

Temperature: -20 °C to +70 °C (-4 °F to +158 °F)

Humidity: 90% at +50 °C maximum relative humidity (non-condensing)

Application Notes

1. Model SM2A31RPD may be destroyed from overload conditions.
2. Low voltage use of the ac receiver requires careful analysis of the load to determine if the leakage current or on-state voltage of the sensor will interfere with proper operation of the load.
3. The false-pulse protection feature may cause momentary drop-out of the load when the sensor is wired in series or parallel with mechanical switch contacts.

Required Overcurrent Protection



WARNING: Electrical connections must be made by qualified personnel in accordance with local and national electrical codes and regulations.

Overcurrent protection is required to be provided by end product application per the supplied table. Overcurrent protection may be provided with external fusing or via Current Limiting, Class 2 Power Supply. Supply wiring leads < 24 AWG shall not be spliced. For additional product support, go to www.bannerengineering.com.

Supply Wiring (AWG)	Required Overcurrent Protection (Amps)
20	5.0
22	3.0
24	2.0
26	1.0
28	0.8
30	0.5

Certifications



Dimensions

DC Models

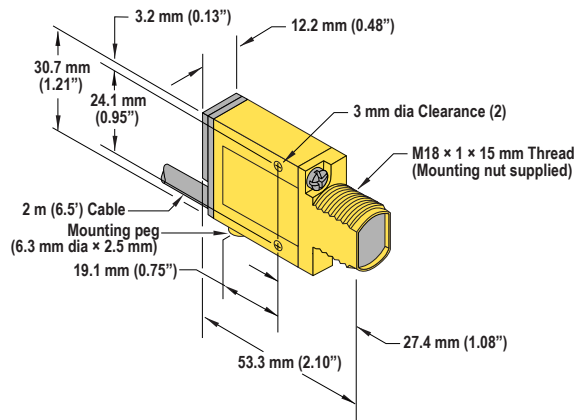

AC Models

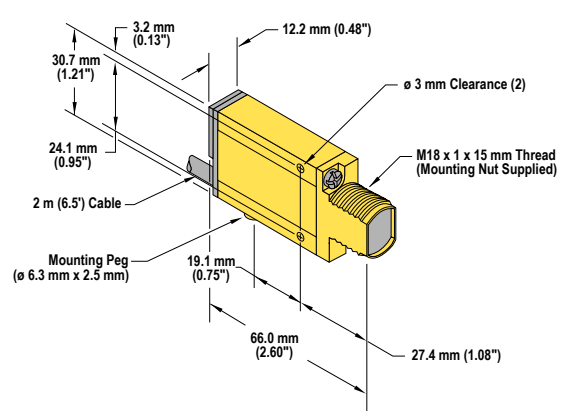

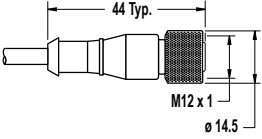
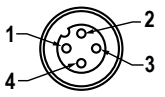
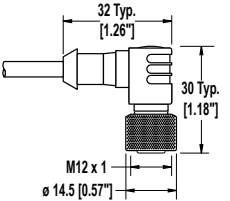

Accessories

Quick Disconnect Cordsets — DC Sensors

4-Pin Threaded M12/Euro-Style Cordsets				
Model	Length	Style	Dimensions	Pinout (Female)
MQDC-406	1.83 m (6 ft)	Straight		 1 = Brown 2 = White 3 = Blue 4 = Black
MQDC-415	4.57 m (15 ft)			
MQDC-430	9.14 m (30 ft)			
MQDC-450	15.2 m (50 ft)			
MQDC-406RA	1.83 m (6 ft)	Right-Angle		
MQDC-415RA	4.57 m (15 ft)			
MQDC-430RA	9.14 m (30 ft)			
MQDC-450RA	15.2 m (50 ft)			

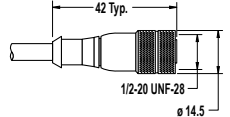
Quick Disconnect Cordsets — AC Sensors

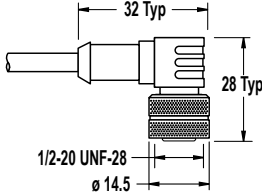
3-Pin Micro-Style Cordsets				
Model	Length	Style	Dimensions	Pinout (Female)
MQDC-306	1.83 m (6 ft)	Straight		 1 = Green 2 = Red/Black 3 = Red/White
MQDC-315	4.57 m (15 ft)			
MQDC-330	9.14 m (30 ft)			
MQDC-306RA	1.83 m (6 ft)	Right-Angle		
MQDC-315RA	4.57 m (15 ft)			
MQDC-330RA	9.14 m (30 ft)			

Banner Engineering Corp. Limited Warranty

Banner Engineering Corp. warrants its products to be free from defects in material and workmanship for one year following the date of shipment. Banner Engineering Corp. will repair or replace, free of charge, any product of its manufacture which, at the time it is returned to the factory, is found to have been defective during the warranty period. This warranty does not cover damage or liability for misuse, abuse, or the improper application or installation of the Banner product.

THIS LIMITED WARRANTY IS EXCLUSIVE AND IN LIEU OF ALL OTHER WARRANTIES WHETHER EXPRESS OR IMPLIED (INCLUDING, WITHOUT LIMITATION, ANY WARRANTY OF MERCHANTABILITY OR FITNESS FOR A PARTICULAR PURPOSE), AND WHETHER ARISING UNDER COURSE OF PERFORMANCE, COURSE OF DEALING OR TRADE USAGE.

This Warranty is exclusive and limited to repair or, at the discretion of Banner Engineering Corp., replacement. **IN NO EVENT SHALL BANNER ENGINEERING CORP. BE LIABLE TO BUYER OR ANY OTHER PERSON OR ENTITY FOR ANY EXTRA COSTS, EXPENSES, LOSSES, LOSS OF PROFITS, OR ANY INCIDENTAL, CONSEQUENTIAL OR SPECIAL DAMAGES RESULTING FROM ANY PRODUCT DEFECT OR FROM THE USE OR INABILITY TO USE THE PRODUCT, WHETHER ARISING IN CONTRACT OR WARRANTY, STATUTE, TORT, STRICT LIABILITY, NEGLIGENCE, OR OTHERWISE.**

Banner Engineering Corp. reserves the right to change, modify or improve the design of the product without assuming any obligations or liabilities relating to any product previously manufactured by Banner Engineering Corp. Any misuse, abuse, or improper application or installation of this product or use of the product for personal protection applications when the product is identified as not intended for such purposes will void the product warranty. Any modifications to this product without prior express approval by Banner Engineering Corp will void the product warranties. All specifications published in this document are subject to change; Banner reserves the right to modify product specifications or update documentation at any time. Specifications and product information in English supersede that which is provided in any other language. For the most recent version of any documentation, refer to: www.bannerengineering.com.