

### Contents

1. NOTICE
2. MOUNTING METHODS
3. EXTERNAL WIRING
4. PART NAMES OF FRONT PANEL AND THEIR FUNCTIONS
5. SWITCHING PARAMETERS
6. PARAMETER SETTING ORDER AND PRECAUTIONS
7. SETTING INPUT-RELATED PARAMETERS
8. SETTING ALARM-RELATED PARAMETERS
9. INPUT ADJUSTMENTS
10. SETTING ACTIVE COLOR PV DISPLAY
11. OTHER PARAMETERS
12. MONITOR OUTPUT
13. TROUBLESHOOTING
14. MAIN SPECIFICATIONS

Keep this manual in a safe place.



IM 77J04R31-01E  
1st Edition : Aug. 2006 (YK)

### CHECKING THE PRODUCT SPECIFICATIONS AND THE CONTENTS OF THE PACKAGE

#### (1) Model and Specifications Check

Check that the model and specifications indicated on the nameplate attached to the side face of the main unit are as ordered. (In checking the model and suffix codes, refer to the main specifications listed on the last page of this manual.)

#### (2) Contents of the Package

- Check that the package contains the following items.
- MVRK: 1
  - User's manual (this manual: IM 77J04R31-01E): 1
- Accessories:
- Tag number label: 1 sheet
  - Range label: 1 sheet
  - Spacer: 1 (used for DIN rail mounting)

## 1. NOTICE

This user's manual should be carefully read before installing and operating the product. The following symbol is used on the product and in this manual to ensure safe use.



**This symbol is displayed on the product when it is necessary to refer to the user's manual for information on personnel and instrument safety. This symbol is displayed in the user's manual to indicate precautions for avoiding danger to the operator, such as an electric shock.**

The following symbols are used only in this manual.



### IMPORTANT

**Indicates that operating the hardware or software in a particular manner may cause damage or result in a system failure.**



### NOTE

**Draws attention to essential information for understanding the operations and/or functions of the product.**

## 2. MOUNTING METHODS

### 2.1 Wall Mounting

Unfasten the upper and lower stoppers to disconnect the main unit from the socket. Next, anchor the socket onto the wall with two M4 screws. Then plug the main unit into the socket and secure the main unit with the upper and lower stoppers.

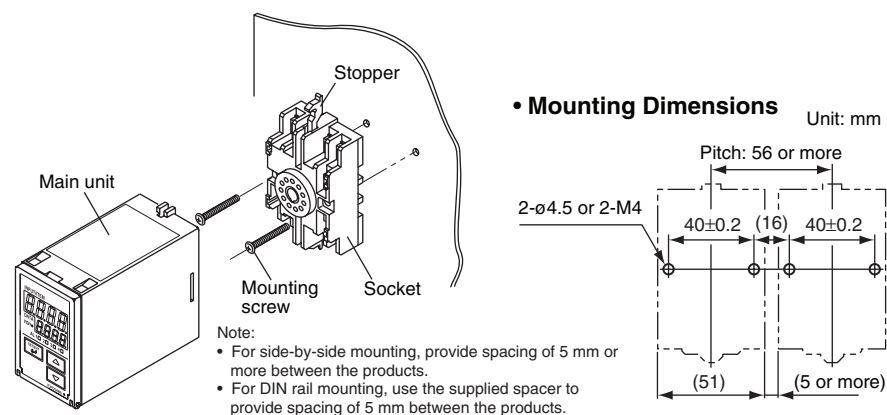

### 2.2 DIN Rail Mounting

Locate the MVRK so that the DIN rail fits into the upper part of the DIN-rail groove at the rear of the socket, and fasten the socket using the slide lock at the lower part of the socket. For side-by-side mounting, attach the spacer supplied with the product to the DIN rail to provide spacing between the products.

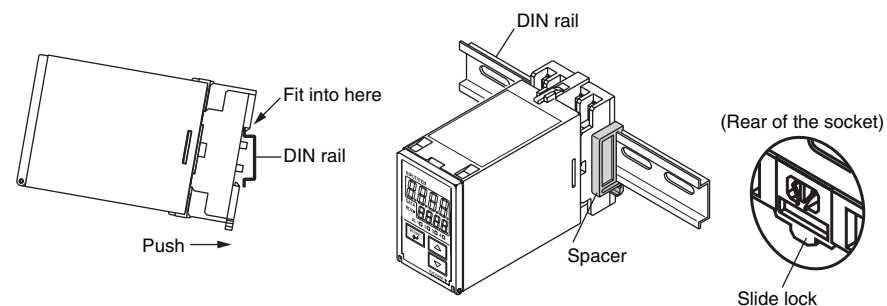

### 2.3 Using a Duct

When using a wiring duct, install the duct at least 30 mm away from the top and bottom faces of the main unit.

### 2.4 Installation Locations

- Avoid the following environments for installation locations:
  - Areas with vibration, corrosive gases, dust, water, oil, solvents, direct sunlight, radiation, a strong electric field and/or a strong magnetic field
- If there is any risk of a surge being induced into the power line and/or signal lines due to lightning or other factors, a dedicated lightning arrester should be used as protection for both the product and a field-installed device.

## 3. EXTERNAL WIRING



### WARNING

**To avoid the risk of an electric shock, turn off the power supply and use a tester or similar device to ensure that no power is supplied to a cable to be connected, before carrying out wiring work.**



### CAUTION

- Use of the product ignoring the specifications may cause overheating or damage. Before turning on the power, ensure the following:
  - (a) Power supply voltage and input signal value applied to the product should meet the required specifications.
  - (b) The external wiring to the terminals and wiring to ground are as specifications.
- Do not operate the product in the presence of flammable or explosive gases or vapors. To do so is highly dangerous.
- If an inductance (L) load such as auxiliary relays or solenoid valves is used, always insert a spark killer for diminishing sparks, such as a CR filter or a diode in parallel with the inductance load. Otherwise a malfunction or relay failure may occur. Refer to the following guidelines for a capacitor and resistor:
  - Capacitor: 0.5 to 1  $\mu$ F with respect to a contact current of 1 A
  - Resistor: 0.5 to 1  $\Omega$  with respect to a contact voltage of 1 V
- Transfer contacts for 2 points of alarms consist of an NO contact and an NC contact. When using transfer contacts, consideration should be given to the risk of a short circuit due to contact MBB<sup>1</sup> resulting from non-concurrent action of the NO and NC contacts or to a short circuit caused by arcs produced when opening a contact at large current.
  - \*1 The condition where both NO and NC contacts close when the contact actuates
- The power line and input/output signal lines should be installed away from noise-generating sources. Otherwise accuracy cannot be guaranteed.
- The product is sensitive to static electricity; exercise care in operating it. Before you operate the product, touch a nearby metal part to discharge static electricity.

Wiring should be connected to the terminals on the socket of the MVRK. The terminals for external connections are of M3.5 screws. Use crimp-on lugs for connections to the terminals.

It is recommended that signal wires have a nominal cross-sectional area of 0.5 mm<sup>2</sup> or thicker, while the power cable has a nominal cross-sectional area of 1.25 mm<sup>2</sup> or thicker. Make the wiring resistance of the input terminals 4 and 6 the same.

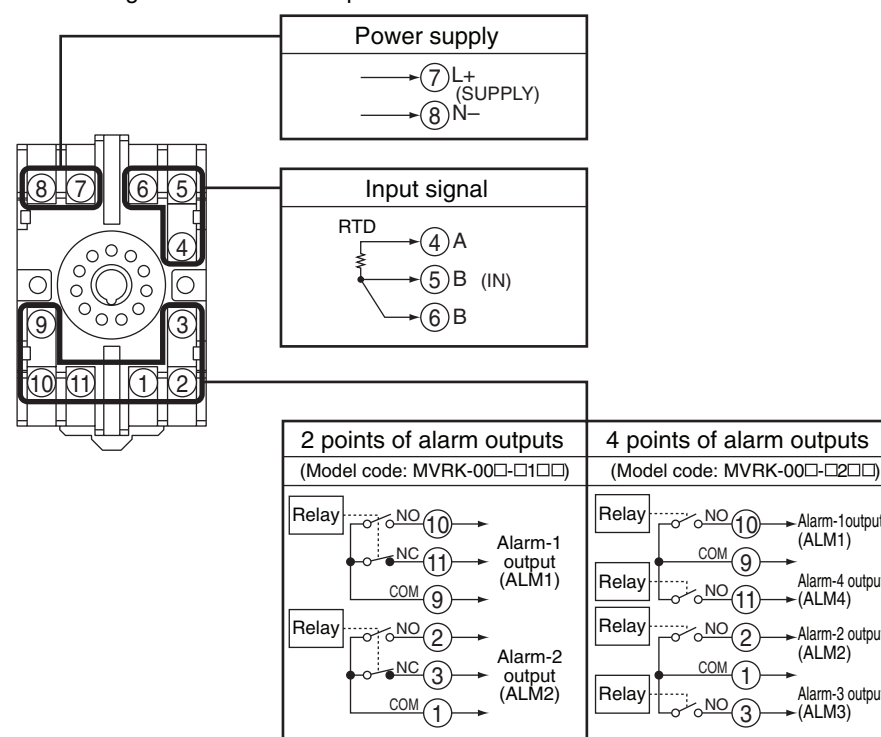

### Wiring for Monitor Output

If the monitor output code (one of 6, A or P) is specified at the time of order, the following wiring is possible.

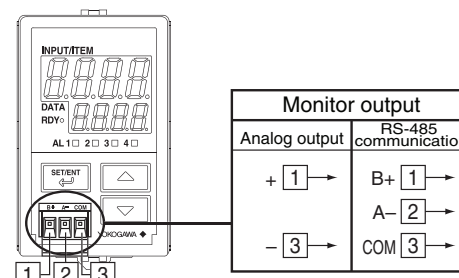

## 4. PART NAMES OF FRONT PANEL AND THEIR FUNCTIONS

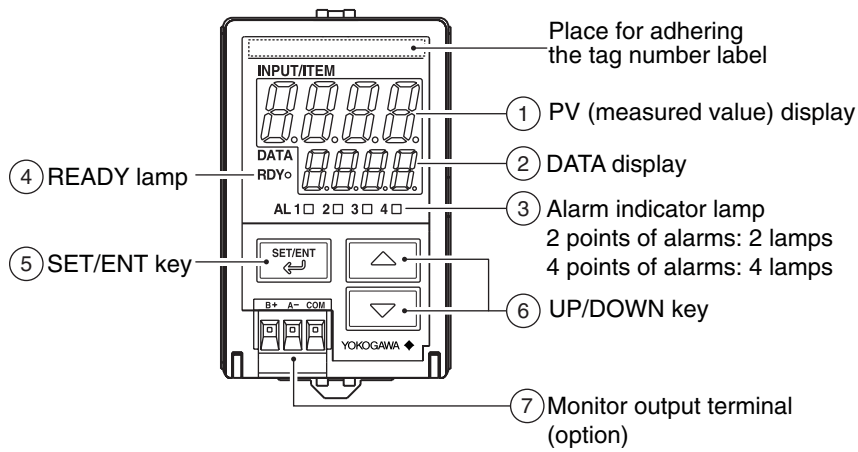

### NOTE

The front panel of the product is constructed to prevent opening. Forcing it open will result in breakage.

Part Name	Function
① PV (measured value) display	Displays a measured value during operation. Displays a parameter symbol when a parameter is set. Displays an error code in the event of an error.
② DATA display	Displays the setpoint of a variety of parameters. Displays an alarm type in the event of an alarm. (Not displayed during normal operation.) H: High-limit alarm L: Low-limit alarm R: Other alarms
③ Alarm indicator lamp	In the event of an alarm, AL1 to AL4 (alarm 1 to alarm 4) light up.
④ READY lamp	Lights up when the power is turned on.
⑤ SET/ENT key	Used to switch parameter indication or accept a setpoint. Pressing this key for more than 3 seconds allows you to select the Operation Parameter Screen and Setup Parameter Screen alternately.
⑥ UP/DOWN key	Used to change the setpoint of a parameter. Pressing the  key increases a numerical value. Pressing the  key decreases a numerical value. Holding down a key accelerates the speed of change.
⑦ Monitor output terminal (Two-piece connector)	Outputs 1 to 5 V DC, 4 to 20 mA DC or RS-485 communication signal. (To be added only when the monitor output has been specified at the time of order.)

## 5. SWITCHING PARAMETERS

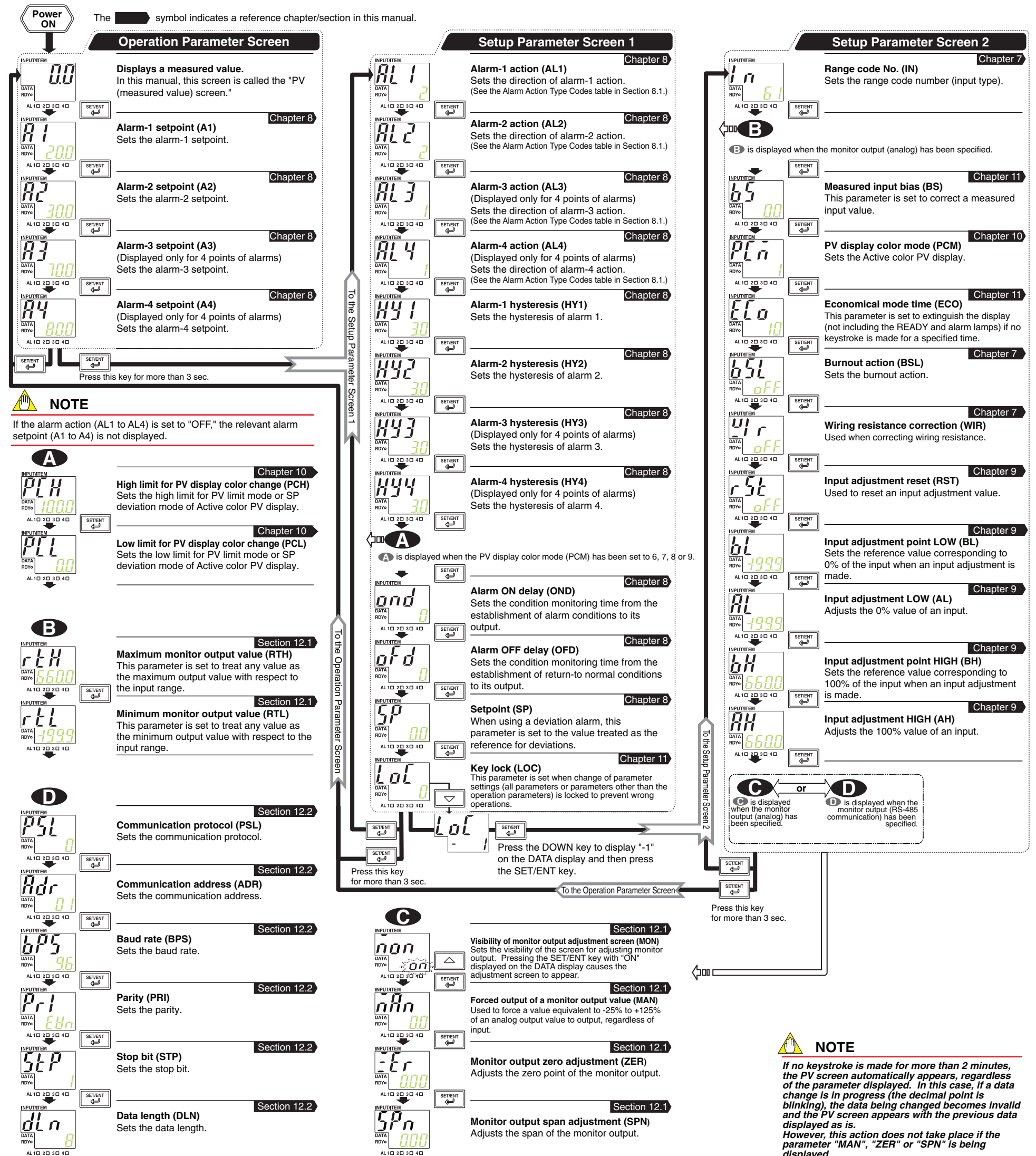

## 6. PARAMETER SETTING ORDER AND PRECAUTIONS

When setting a parameter, begin with Step 1 below and continue in sequence.

Range code No. (IN) Alarm-1 action (AL1) Alarm-2 action (AL2) Alarm-3 action (AL3) Alarm-4 action (AL4)

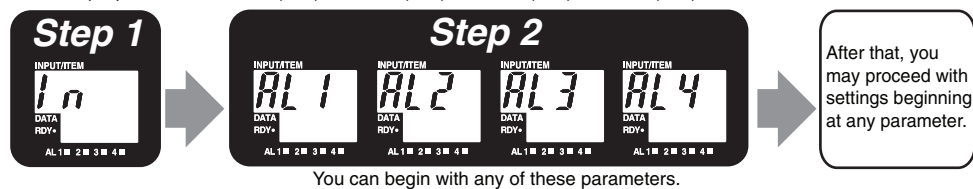

### NOTE

**If the settings for the range code No. (IN) or alarm actions (AL1 to AL4) are changed, the relevant parameter setpoints shown in the table below will be initialized. To change a parameter setpoint, begin with Step 1 above and continue in sequence.**

Parameters to be initialized if the range code No. (IN) is changed
Alarm setpoints (A1 to A4), hysteresis (HY1 to HY4), setpoint (SP)
Max. and min. monitor output values (RTH, RTL)
Input adjustment point LOW (BL) and HIGH (BH), input adjustment LOW (AL) and HIGH (AH), wiring resistance correction (WIR)
High and low limits for PV display color change (PCH, PCL)
Parameters to be initialized if the type of alarm action (AL1 to AL4) is changed
The alarm setpoint (A1 to A4) corresponding to each alarm action (AL1 to AL4) (Example: If AL1 is changed, A1 will be initialized.)
Parameters to be initialized if the type of PV display color mode (PCM) is changed
High and low limits for PV display color change (PCH, PCL)

## 7. SETTING INPUT-RELATED PARAMETERS

### 7.1 Setting Ranges and Factory-Set Values of Input-Related Parameters

#### Setup Parameter Screen 2

Parameter Symbol	Parameter Name	Setting Range	Factory-Set Value
IN	Range code No. (IN)	Range code No.	61 or the range code No. specified at the time of order
		61 H range Pt100 -199.9 to 660.0°C	
		62 M range (ITS-90) -199.9 to 200.0°C	
		63 H range Pt100 -199.9 to 660.0°C	
		64 M range (IPTS-68) -199.9 to 200.0°C	
		65 H range JPt100 -199.9 to 510.0°C	
		66 M range (JIS'89) -199.9 to 190.0°C	
		67 M range Pt50(JIS'81) -199.9 to 649.0°C	
		71 H range Pt100 80.0 to 930.0 K	
		72 M range (ITS-90) 80.0 to 470.0 K	
		73 H range Pt100 80.0 to 930.0 K	
		74 M range (IPTS-68) 80.0 to 470.0 K	
		75 H range JPt100 80.0 to 780.0 K	
		76 M range (JIS'89) 80.0 to 460.0 K	
77 M range Pt50(JIS'81) 80.0 to 920.0 K			
BSL	Burnout action (BSL)	OFF (0), UP (1), DOWN (2)	According to the suffix codes specified at the time of order
WIR	Wiring resistance correction (WIR)	OFF (0), ON (1)	OFF

Note: When used with BARD-700, use the H range. Ranges other than H range cannot be used for BARD-700.

### 7.2 Setting Range Code No.

This section describes an example of setting the range code No. (IN) to "62" (instrument input range: -199.9 to 200.0°C).



#### NOTE

**Note that setting the range code No. (IN) to a value other than those specified in Section 7.1 is invalid.**

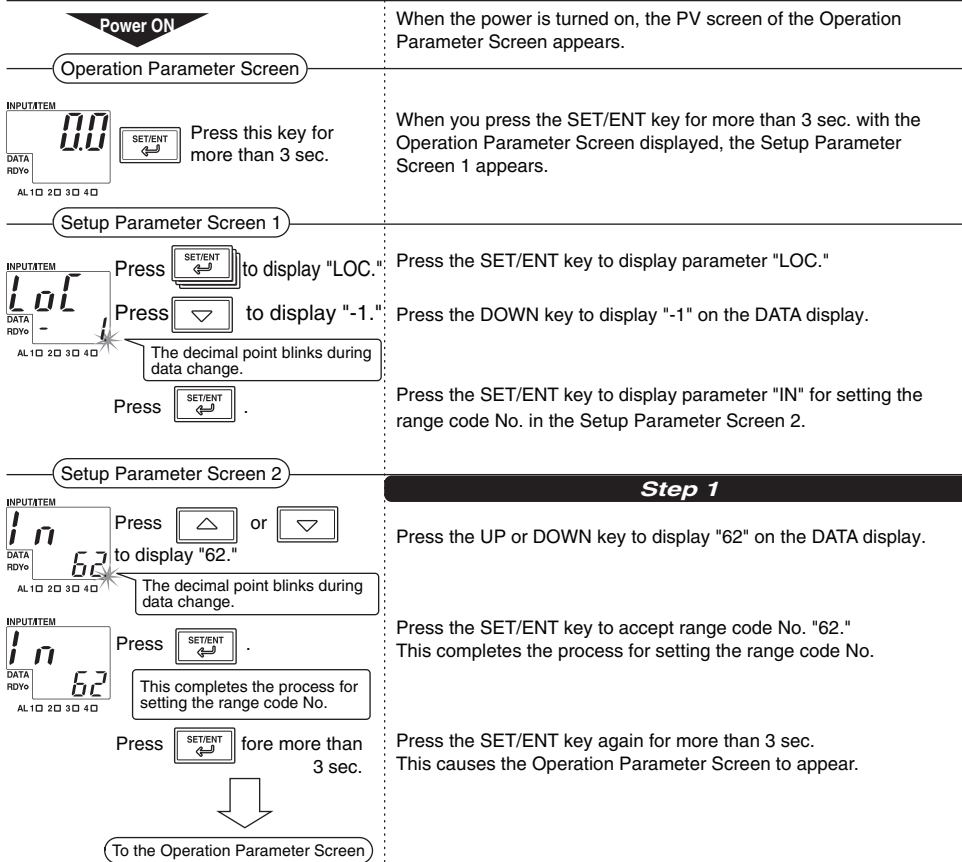

### 7.3 Setting Burnout Action

This section describes an example of setting the burnout action to "UP." The procedure below begins with the condition in which the Setup Parameter Screen 2 is displayed.

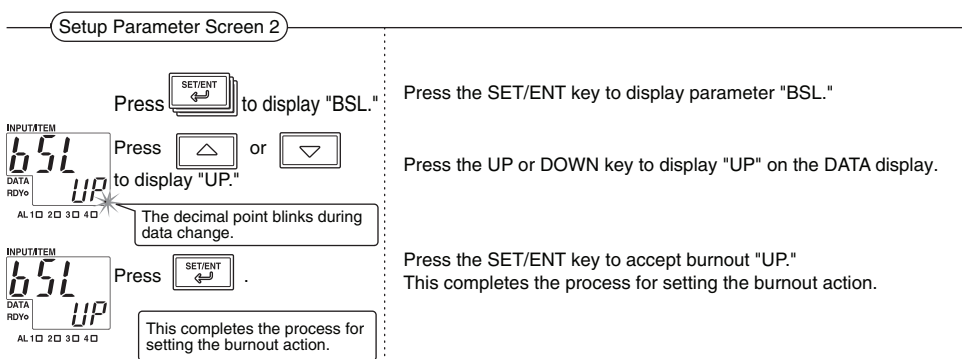

### 7.4 Correcting Wiring Resistance

This section describes how to correct wiring resistance when an error occurs due to the influence of the input wiring resistance. Correct wiring resistance after completing the wiring.

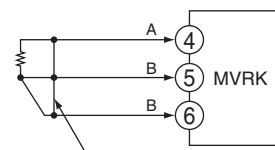

Short-circuit at the cable end.

The procedure below begins with the condition in which the Setup Parameter Screen 2 is displayed.

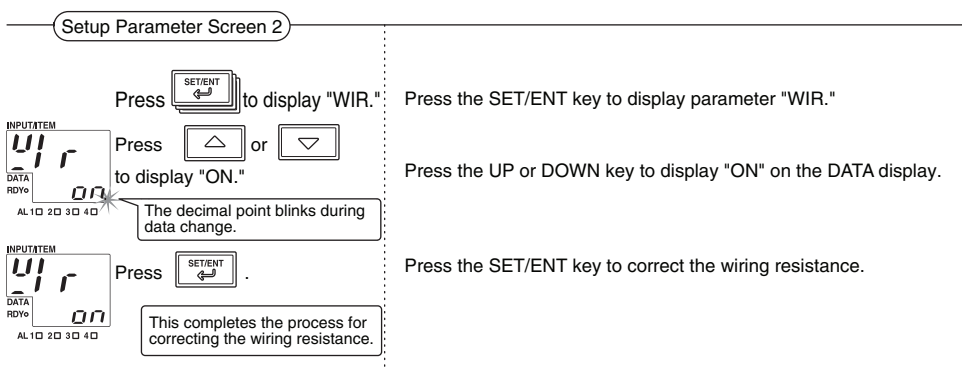

#### NOTE

**If the burnout action setting is changed, the wiring resistance correction is automatically set to OFF (0). Correct the wiring resistance again after changing the burnout action setting.**

## 8. SETTING ALARM-RELATED PARAMETERS

### 8.1 Setting Ranges and Factory-Set Values of Alarm-Related Parameters

The followings are the factory-set values for the range code No. 61. They may differ depending on the range code No. specified at the time of order.

#### Operation Parameter Screen

Parameter Symbol	Parameter Name	Setting Range	Factory-Set Value
<i>A1</i>	Alarm-1 setpoint (A1)	Within the instrument input range.	20.0
<i>A2</i>	Alarm-2 setpoint (A2)	Within the instrument input range.	2 points of alarms: 80.0 4 points of alarms: 30.0
<i>A3</i>	Alarm-3 setpoint (A3)		
<i>A4</i>	Alarm-4 setpoint (A4)		80.0

#### Setup Parameter Screen 1

Parameter Symbol	Parameter Name	Setting Range	Factory-Set Value
<i>AL1</i>	Alarm-1 action (AL1)	See the Alarm Action Type Codes table.	2
<i>AL2</i>	Alarm-2 action (AL2)	See the Alarm Action Type Codes table.	2 points of alarms: 1 4 points of alarms: 2
<i>AL3</i>	Alarm-3 action (AL3)		
<i>AL4</i>	Alarm-4 action (AL4)		
<i>HY1</i>	Alarm-1 hysteresis (HY1)		The value resulting from adding a hysteresis value to an alarm setpoint should be within the instrument input range.
<i>HY2</i>	Alarm-2 hysteresis (HY2)		3.0
<i>HY3</i>	Alarm-3 hysteresis (HY3)		3.0
<i>HY4</i>	Alarm-4 Hysteresis (HY4)		3.0
<i>ond</i>	Alarm ON delay (OND)	Setting range: 0 to 999 sec. Setting resolution: 1 sec.	0
<i>ofd</i>	Alarm OFF delay (OFD)	Setting range: 0 to 999 sec. Setting resolution: 1 sec.	0
<i>SP</i>	Setpoint (SP)	Within the instrument input range.	Minimum value of the instrument input range

#### <Alarm Action Type Codes>

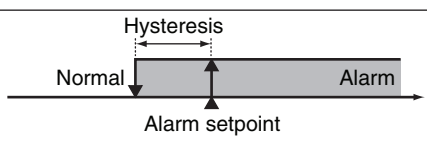
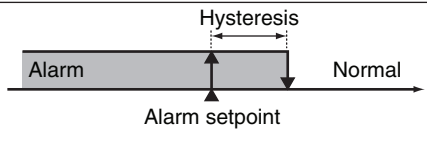
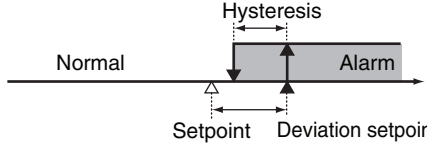
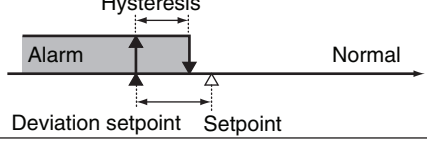
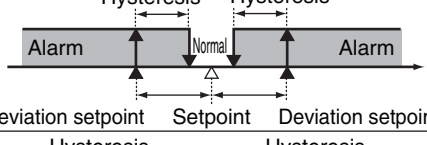
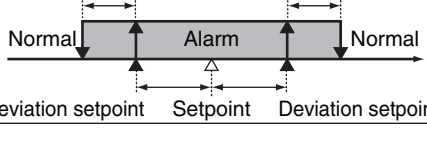
Alarm Type	Alarm Action	Alarm Action Type Code			
		Without Stand-by Action		With Stand-by Action	
		De-energized under Normal Condition	Energized under Normal Condition	De-energized under Normal Condition	Energized under Normal Condition
PV high-limit alarm		1	9	11	19
PV low-limit alarm		2	10	12	20
Deviation high-limit alarm		3	5	13	15
Deviation low-limit alarm		4	6	14	16
Deviation high and low-limit alarm		7		17	
Deviation within high and low-limit alarm		8		18	
No alarm		<i>off</i> (Parameters A1 to A4 are not displayed.)			

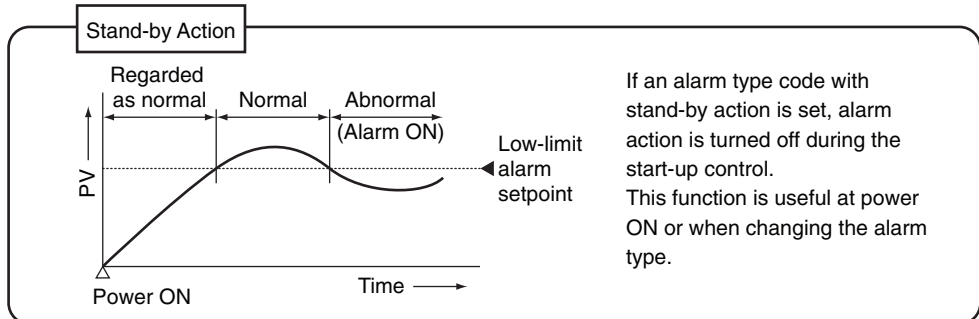

### 8.2 Setting Alarm Output-Related Parameters

This section describes an example of setting the alarm-1 action (AL1) to "12" (PV low-limit alarm, with stand-by action), alarm-1 setpoint (A1) to "0" (°C), alarm-1 hysteresis 1 (HY1) to "5" (°C), alarm ON delay (OND) to "5" (sec.) and alarm OFF delay (OFD) to "5" (sec.) with the range code No. (IN) set to "62" (instrument input range: -199.9 to 200.0°C). (Parameters relating to alarm 2 to alarm 4 can be set in the same way as the procedure below.)

**Power ON**  
When the power is turned on, the PV screen of the Operation Parameter Screen appears.

**Operation Parameter Screen**  
When the SET/ENT key is pressed for more than 3 sec. with the Operation Parameter Screen displayed, the Setup Parameter Screen 1 appears with parameter "AL1" displayed.

**Step 2**  
Press the UP or DOWN key to display "12" on the DATA display.  
Press the SET/ENT key to accept alarm-1 action "12."  
Then to set the alarm setpoint, press the SET/ENT key for more than 3 sec. to display the Operation Parameter Screen. (To set the hysteresis parameter and successive settings, press the SET/ENT key to display the next parameter.)

**Operation Parameter Screen**  
Press the SET/ENT key to display parameter "A1."  
Press the UP or DOWN key to display a low-limit alarm value "0.0" (°C) that is set to the DATA display.  
Press the SET/ENT key to accept low-limit alarm "0.0" (°C).

**Setup Parameter Screen 1**  
Press the UP or DOWN key to display "5.0" (°C) on the DATA display.  
Press the SET/ENT key to accept alarm-1 hysteresis "5.0" (°C).  
Press the SET/ENT key to display parameter "OND."  
Press the UP or DOWN key to display "5" (sec.) on the DATA display.  
Press the SET/ENT key to accept alarm ON delay "5" (sec).  
Press the SET/ENT key again to display parameter "OFD."  
Press the UP or DOWN key to display "5" (sec.) on the DATA display.  
Press the SET/ENT key to accept alarm OFF delay "5" (sec).  
Press the SET/ENT key for more than 3 sec. This causes the Operation Parameter Screen to appear.

**Setup Parameter Screen 1**  
To the Operation Parameter Screen

## 9. INPUT ADJUSTMENTS

### 9.1 Setting Ranges and Factory-Set Values of Adjustment-Related Parameters

#### Setup Parameter Screen 2

Parameter Symbol	Parameter Name	Setting Range	Factory-Set Value
<i>rSt</i>	Input adjustment reset (RST)	OFF (0) or ON (1) (This parameter is used (set to ON) to reset adjusted values.)	OFF
<i>bl</i>	Input adjustment point LOW (BL)	±10% of the instrument input range span (and BL < BH)	Minimum value of the instrument input range
<i>al</i>	Input adjustment LOW (AL)	±10% of the instrument input range span (and AL < AH)	Minimum value of the instrument input range
<i>bh</i>	Input adjustment point HIGH (BH)	±10% of the instrument input range span (and BL < BH)	Maximum value of the instrument input range
<i>ah</i>	Input adjustment HIGH (AH)	±10% of the instrument input range span (and AL < AH)	Maximum value of the instrument input range

## 9.2 Instrument for Adjustments

- 6-dial variable resistor (Yokogawa Meters & Instruments' 2793 01 or equivalent): 1

### 9.3 Input Adjustment

#### 9.3.1 Connecting the Adjustment Instrument

Connect the input and supply voltage as shown in the figure below.

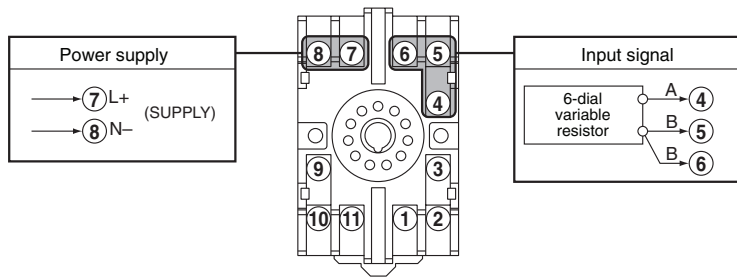

#### 9.3.2 Adjusting Inputs

Carry out input adjustments between two points, or the minimum value (BL: input adjustment point LOW) and maximum value (BH: input adjustment point HIGH) that have been set within the adjustment range (see Section 9.1). This subsection describes an example of making an input adjustment between two points within the range of -50.0 to 150.0°C with the MVRK range code No. set to "62" (instrument input range: -199.9 to 200.0°C).

The MVRK enters the operable status as soon as the power is turned on, but requires 10 to 15 minutes of warm-up to meet the performance requirements.

**Power ON**  
When the power is turned on, the PV screen of the Operation Parameter Screen appears.

**Operation Parameter Screen**  
When you press the SET/ENT key for more than 3 sec. with the Operation Parameter Screen displayed, the Setup Parameter Screen 1 appears.

**Setup Parameter Screen 1**  
Press the SET/ENT key to display "LOC."  
Press the DOWN key to display "-1."  
The decimal point blinks during data change.  
Press the SET/ENT key.  
Press the SET/ENT key to display the Setup Parameter Screen 2.

**Setup Parameter Screen 2**  
Press the SET/ENT key to display parameter "BL."  
In this case, the DATA display shows "-199.9," the minimum value of instrument input range of the set range code No.  
Press the UP key to display "-50.0."  
The decimal point blinks during data change.  
Press the SET/ENT key to accept this data.  
Press the SET/ENT key to display the next parameter.  
Press the SET/ENT key.  
Using the 6-dial variable resistor, apply resistance equivalent to the input -50°C to the MVRK.  
This causes parameter "AL" and the measured value to appear alternately.  
Press the UP or DOWN key.  
The decimal point blinks.  
Press the SET/ENT key.  
The value before adjustment (-52.2) appears on the DATA display.  
Press the SET/ENT key to display the next parameter "BH."  
In this case, the DATA display shows "200.0," the maximum value of instrument input range of the set range code No.  
Press the DOWN key to display "150.0" on the DATA display.  
The decimal point blinks during data change.  
Press the SET/ENT key to accept this data.  
Press the SET/ENT key to display the next parameter.  
Press the SET/ENT key.  
Using the 6-dial variable resistor, apply resistance equivalent to the input 150°C to the MVRK.  
This causes parameter "AH" and the measured value to appear alternately.  
Press the UP or DOWN key.  
The decimal point blinks.  
Press the SET/ENT key.  
The value before adjustment (153.9) appears on the DATA display.  
This completes the input adjustment for the MVRK.

If additional re-adjustment must be made, take the following steps and then perform the procedure above.

**Setup Parameter Screen 2**  
Press the SET/ENT key to display parameter "RST."  
Press the UP key to display "ON" on the DATA display.  
The decimal point blinks during data change.  
Press the SET/ENT key.  
The previously adjusted value will be reset.  
Press the SET/ENT key to display parameter "RST."  
Press the UP key to display "ON" on the DATA display.  
Press the SET/ENT key.  
This resets the previously adjusted value.

## 10. SETTING ACTIVE COLOR PV DISPLAY (PV DISPLAY COLOR CHANGING FUNCTION)

### 10.1 Setting Ranges and Factory-Set Values

#### Setup Parameter Screen 1

Parameter Symbol	Parameter Name	Setting Range	Factory-Set Value
PCH	High limit for PV display color change (PCH)	When PV display color mode (PCM) is 6 or 7: PCL+1digit to 9999 When PV display color mode (PCM) is 8 or 9: -100.0 to 100.0% of the measured input range * The setting range depends on the setting of the decimal point position (SDP).	-
PCL	Low limit for PV display color change (PCL)	When PV display color mode (PCM) is 6 or 7: -1999 to PCH-1digit When PV display color mode (PCM) is 8 or 9: -100.0 to 100.0% of the measured input range * The setting range depends on the setting of the decimal point position (SDP).	-

#### Setup Parameter Screen 2

Parameter Symbol	Parameter Name	Setting Range	Factory-Set Value
PCn	PV display color mode (PCM)	0: Fixed in green 1: Fixed in red 2: Link to alarm 1 (under normal condition: green; at alarm status: red) 3: Link to alarm 1 (under normal condition: red; at alarm status: green) 4: Link to alarm 1 and alarm 2 (under normal condition: green; at alarm status: red) 5: Link to alarm 1 and alarm 2 (under normal condition: red; at alarm status: green) 6: PV limit* (when more than PCL, less than PCH: green; when PCL or less, PCH or more: red) 7: PV limit* (when more than PCL, less than PCH:red; when PCL or less, PCH or more: green) 8: SP deviation* (when more than SP-PCL, less than SP+PCH: green; when SP-PCL or less, SP+PCH or more: red) 9: SP deviation* (when more than SP-PCL, less than SP+PCH: red; when SP-PCL or less, SP+PCH or more: green) 10: Link to alarm 1 to alarm 4 (under normal condition: green; at alarm status: red) 11: Link to alarm 1 to alarm 4 (under normal condition: red; at alarm status: green)	1

\*: PV display color is changed linking to the setting range of high limit (PCH) and low limit (PCL) for PV display color change.

### 10.2 Setting Active Color PV Display

This section describes an example of setting the PV display color mode (PCM) to "6," high limit for PV display color change (PCH) to "70.0" and low limit (PCL) to "20.0." The procedure below begins with the condition in which the Setup Parameter Screen 2 is displayed.

**Setup Parameter Screen 2**  
Press the SET/ENT key to display parameter "PCM."  
Press the UP or DOWN key to display "6" on the DATA display.  
The decimal point blinks during data change.  
Press the SET/ENT key to accept PV display color mode "6."  
This completes the process for setting the PV display color mode.  
Press the SET/ENT key for more than 3 sec.  
This causes the Operation Parameter Screen to appear.

**Operation Parameter Screen**  
When you press the SET/ENT key for more than 3 sec. with the Operation Parameter Screen displayed, the Setup Parameter Screen 1 appears.

**Setup Parameter Screen 1**  
Press the SET/ENT key to display parameter "PCH."  
Press the UP or DOWN key to display "70.0" on the DATA display.  
The decimal point blinks during data change.  
Press the SET/ENT key to accept the high limit for PV display color change "70.0."  
This completes the process for setting the high limit for PV display color change.  
Press the SET/ENT key to display parameter "PCL."  
Press the UP or DOWN key to display "20.0" on the DATA display.  
The decimal point blinks during data change.  
Press the SET/ENT key to accept the low limit for PV display color change "20.0."  
This completes the process for setting the low limit for PV display color change.  
Press the SET/ENT key for more than 3 sec.  
This causes the Operation Parameter Screen to appear.

To the Operation Parameter Screen

## 11. OTHER PARAMETERS

### 11.1 Setting Ranges and Factory-Set Values

#### Setup Parameter Screen 1

Parameter Symbol	Parameter Name	Setting Range	Factory-Set Value
LoL	Key lock (LOC)	0: Without lock. All parameters can be set. 1: Parameters other than the operation parameters cannot be changed. 2: All parameters cannot be changed. -1: This moves to the Setup Parameter Screen 2.	0

#### Setup Parameter Screen 2

Parameter Symbol	Parameter Name	Setting Range	Factory-Set Value
b5	Measured input bias (BS)	-1999 to 9999	0
ELo	Economical mode time (ECO)	0 (Continuous: no display OFF function), 1 to 60 (minutes)	10

### 11.2 Setting Key Lock

This section describes an example of locking keys so that parameter settings other than the operation parameters cannot be changed. The procedure below begins with the condition in which the Setup Parameter Screen 1 is displayed.

Setup Parameter Screen 1

Press to display "LOC."  
Press to display "1."  
The decimal point blinks during data change.  
Press to accept this data.

Press the SET/ENT key to display parameter "LOC."  
Press the UP key to display "1" on the DATA display.  
Press the SET/ENT key to accept this data.

### 11.3 Setting Economical Mode Time

Setting economical mode time allows indications on the PV display to be extinguished if no keystroke is made within the set time.

The MVRK's power consumption in the OFF mode is approximately 0.5 W or 1 VA during normal operations (non-alarm status). This section describes an example of setting the economical mode time to "5 minutes" (factory-set value: 10 minutes).

The procedure below begins with the condition in which the Setup Parameter Screen 2 is displayed.

Setup Parameter Screen 2

Press to display "ECO."  
Press to display "5."  
The decimal point blinks during data change.  
Press to accept this data.

Press the SET/ENT key to display parameter "ECO."  
Press the DOWN key to display "5" on the DATA display.  
Press the SET/ENT key to accept this data.

#### NOTE

**The economical mode is temporarily released at the time of PV display color change and the PV display lights up. After the set economical mode time elapsed from the time of returning to normal operation, the economical mode operation begins again.**

### 11.4 Setting Input Bias

This section describes an example of correcting an error by setting input bias if there is an error of "-1 (°C)" in the MVRK displayed value with respect to the measured value. The procedure below begins with the condition in which the Setup Parameter Screen 2 is displayed.

Setup Parameter Screen 2

Press to display "BS."  
Press to display "1.0."  
The decimal point blinks during data change.  
Press to accept this data.

Press the SET/ENT key to display parameter "BS."  
Press the UP key to display "1.0" on the DATA display.  
Press the SET/ENT key to accept this data.

## 12. MONITOR OUTPUT

### 12.1 Monitor Output (Analog)

Monitor output (analog) is added only when monitor output code "6" or "A" is specified at the time of order.

#### 12.1.1 Setting Monitor Output

In setting monitor output, the maximum monitor output value (RTH) and minimum monitor output value (RTL) can be freely set within the instrument input range of the set range code No. (IN) that have been set for the MVRK.

For example, to set the monitor output corresponding to the measured input range "-50.0 to 150.0°C" to "1 to 5 V DC" when the MVRK range code No. (IN) is "62" (instrument input range: -199.9 to 200.0°C), set the maximum monitor output value (RTH) to "150.0" and the minimum monitor output value (RTL) to "-50.0." This causes monitor output to be "1 V" when input to the MVRK is 50.0°C as shown below.

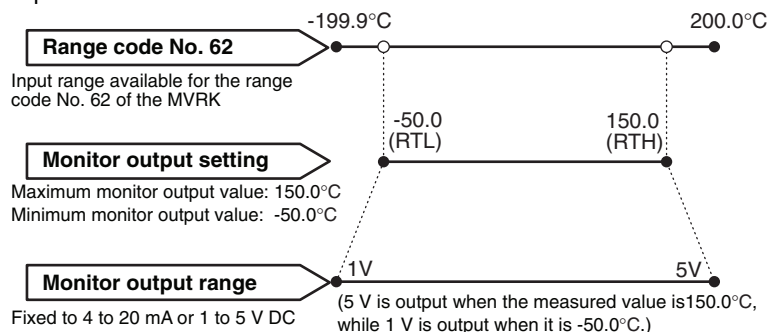

### 12.1.2 Setting Ranges and Factory-Set Values of Monitor Output (Analog)-Related Parameters

#### Setup Parameter Screen 2

Parameter Symbol	Parameter Name	Setting Range	Factory-Set Value
rth	Maximum monitor output value (RTH)	RTL + 1 digit to 9999 Within the instrument input range	Maximum value of the instrument input range
rtl	Minimum monitor output value (RTL)	-1999 to RTH - 1 digit Within the instrument input range	Minimum value of the instrument input range
non	Visibility of monitor output adjustment screen (MON)	OFF (invisible) or ON (visible) Set this parameter to "ON" for adjustments of monitor output.	OFF (invisible)
nan	Forced output of a monitor output value (MAN)	-25.0 to +125.0 (%) Note that the assured range is -6.0 to +106 (%).	0.0
zer	Monitor output zero adjustment (ZER)	-19.99 to 20.00 (%)	0.00
spn	Monitor output span adjustment (SPN)	-19.99 to 20.00 (%)	0.00

### 12.1.3 Setting Monitor Output



#### NOTE

**Accuracy ( $\pm 0.1\%$  of output span) is limited depending on the settings for maximum and minimum monitor output values. For more information on accuracy limitations, refer to the main specifications on the last page of this manual.**

This subsection describes an example of setting the maximum monitor output value (RTH) to "150.0" and minimum monitor output value (RTL) to "-50.0" when the MVRK range code No. is set to "62."

Power ON

When the power is turned on, the PV screen of the Operation Parameter Screen appears.

Operation Parameter Screen

Press this key for more than 3 sec.

When you press the SET/ENT key for more than 3 sec. with the Operation Parameter Screen displayed, the Setup Parameter Screen 1 appears.

Setup Parameter Screen 1

Press to display "LOC."  
Press to display "-1."  
The decimal point blinks during data change.  
Press .

Press the SET/ENT key to display parameter "LOC."  
Press the DOWN key to display "-1" on the DATA display.  
Press the SET/ENT key to display the Setup Parameter Screen 2.

Setup Parameter Screen 2

Press to display "RTH."  
Press to display "150.0."  
The decimal point blinks during data change.  
Press .

Press the SET/ENT key to display parameter "RTH."  
In this case, the DATA display shows "200.0," the maximum value of instrument input range of the range code No. "62."  
Press the DOWN key to display "150.0" on the DATA display.  
Press the SET/ENT key to accept this data.  
This completes the procedure for setting the maximum monitor output value.  
Press the SET/ENT key to display the next parameter.

Setup Parameter Screen 2

Press to display "RTL."  
Press to display "-50.0."  
The decimal point blinks during data change.  
Press .

Press the SET/ENT key to display parameter "RTL."  
In this case, the DATA display shows "-199.9," the minimum value of instrument input range of the range code No. "62."  
Press the UP key to display "-50.0" on the DATA display.  
Press the SET/ENT key to accept this data.  
This completes the procedure for setting the minimum monitor output value.

### 12.1.4 Adjusting Monitor Output

#### (1) Instruments for adjustment

- Voltmeter (Yokogawa's 7562 or equivalent): 1
- Precision resistor of  $250 \Omega \pm 0.01\%$ , 1 W: 1

#### (2) Output adjustments

Connect each instrument as shown below.

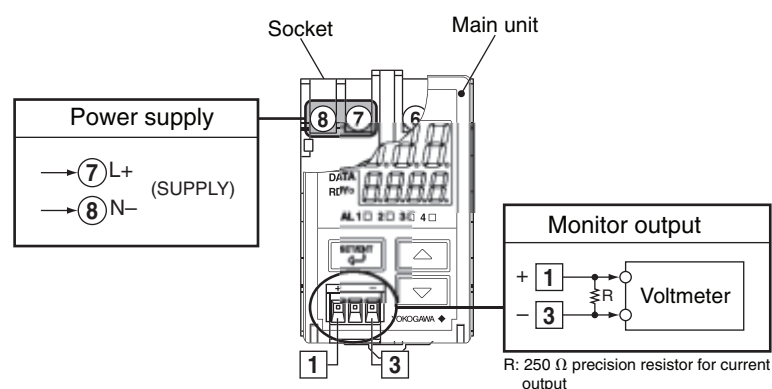

#### (3) Adjusting monitor output

The following describes an example of adjusting an error when the minimum monitor output value (measured value) is 1.008 V (an error of 0.008 V) with the MVRK monitor output set to "1 to 5 V DC." The basic adjusting procedure for the maximum monitor output value is the same as that of the minimum monitor output value; perform it by referring to the procedure below. The procedure below begins with the condition in which the Setup Parameter Screen 2 is displayed.

The MVRK enters the operable status as soon as the power is turned on, but requires 10 to 15 minutes of warm-up to meet the performance requirements.

### Setup Parameter Screen 2

Press to display "MON."

Press the SET/ENT key to display parameter "MON."

Press to display "ON."

Press the UP key to display "ON" on the DATA display.

Press .

Press the SET/ENT key to accept the data.

This establishes the setting in which the monitor output adjustment screen becomes visible.

Press to display "ZER."

Press the SET/ENT key twice to display parameter "ZER."

The minimum output value (1 V) is output forcibly.

**When this parameter (ZER) is displayed, the MVRK forcibly outputs the minimum monitor output value (0%), regardless of input.**

$$\text{Error} = \frac{(\text{Measured value [1.008 V]} - (\text{Reference value [1 V]})}{\text{Output span [4 V]}} \times 100 (\%)$$

The monitor output is corrected by -0.2% because the error is +0.008 V (+0.2%).

(Displays a correction value corresponding to the error.)

Press to display "-0.20."

Press or to make fine adjustments.

This completes the process for adjusting the minimum monitor output value.

Press the UP key to display "-0.20" on the DATA display. Then press the UP or DOWN key to make fine adjustments.

Follow the same procedure as above to adjust the maximum monitor output value.

The maximum output value (5 V) is output forcibly.

Make adjustments to the maximum monitor output value by displaying parameter "SPN."

After adjusting the monitor output, set the MON parameter to "OFF" (making the adjustment screen invisible).

Press to display "OFF."

Display parameter "MON" and press the DOWN key to display "OFF" on the DATA display.

Press .

Press the SET/ENT key to accept the data.

This establishes the setting in which the monitor output adjustment screen becomes invisible.

### 12.1.5 Using the Forced Output Function

The use of the forced output function allows you to conduct operation tests for a device connected to the monitor output terminals of the MVRK. This subsection describes an example of forcing a value equivalent to 50% of the output range (3 V) to output when the monitor output of the MVRK is "1 to 5 V DC." The procedure below begins with the condition in which parameter "MAN" is displayed with the MON parameter set to "ON" in the Setup Parameter Screen 2.

### Setup Parameter Screen 2

The minimum output value (1 V) is output forcibly.

Pressing causes the output value to increase.

Press the UP key to display "50.0" on the DATA display.

The value equivalent to 50% of the output range (3 V) is output forcibly.

3 V is output forcibly. The MVRK continues to output while this parameter is displayed on the screen.

After completion of the forced output, return the MON parameter to "OFF" (making the adjustment screen invisible).

### IMPORTANT

After performing monitor output adjustments or forced output, always set the MON parameter to "OFF" (making the adjustment screen invisible). If the Setup Parameter Screen 2 is switched while the MON parameter is set to "ON," displaying parameter "MAN," "ZER" or "SPN" causes a value corresponding to the set value to be output forcibly. Furthermore, if the power is turned off while parameter "MAN" is displayed, the set values will be initialized.

## 12.2 Monitor Output (Communication)

Monitor output (communication) is added only when the monitor output code "P" is specified at the time of order.

### 12.2.1 Setting Ranges and Factory-Set Values of Monitor Output (Communication)-Related Parameters

#### Setup Parameter Screen 2

Parameter Symbol	Parameter Name	Setting Range	Factory-Set Value
PSL	Communication protocol (PSL)	0: PC link 1: PC link with SUM 2: Ladder communication 3: MODBUS ASCII 4: MODBUS RTU	0 (PC link)
Adr	Communication address (ADR)	1 to 99	1
bPS	Baud rate (BPS)	1.2 (0: 1200 bps) 2.4 (1: 2400 bps) 4.8 (2: 4800 bps) 9.6 (3: 9600 bps)	9.6 (9600 bps)
Pri	Parity (PRI)	NON (0: None) EVN (1: Even) ODD (2: Odd)	EVN (Even)
STP	Stop bit (STP)	1 or 2 (bits)	1
dLn	Data length (DLN)	7 or 8 (bits)	8

## 12.2.2 Setting the Communication-Related Parameters

**Power ON**

When the power is turned on, the PV screen of the Operation Parameter Screen appears.

Press this key for more than 3 sec.

When you press the SET/ENT key for more than 3 sec. with the Operation Parameter Screen displayed, the Setup Parameter Screen 1 appears.

**Setup Parameter Screen 1**

Press to display "LOC."

Press the SET/ENT key to display parameter "LOC."

Press to display "-1."

Press the DOWN key to display "-1" on the DATA display.

The decimal point blinks during data change.

Press .

Press the SET/ENT key to display the Setup Parameter Screen 2.

**Setup Parameter Screen 2**

Press to display "PSL."

Press the SET/ENT key to display parameter "PSL" for setting the communication protocol.

Press or to display the communication protocol number on the DATA display.

Press the SET/ENT key to accept this data.

This completes the process for setting the communication protocol.

Press .

Press the SET/ENT key to display the next parameter.

Follow the same procedure to set the following parameters:

Parameter "ADR" for setting the communication address

Parameter "BPS" for setting the baud rate

Parameter "PRI" for setting the parity

Parameter "STP" for setting the stop bit

Parameter "DLN" for setting the data length

### See Also

For more information on the communication functions, refer to the M Series Digital Limit Alarms Communication Functions User's Manual (IM 77J04J11-01E) sold separately.

## 13. TROUBLESHOOTING

### Possible Errors Occurring at Power ON

The following describes possible errors occurring at power ON.

Error Indication			Description of Error	Status			Remedy
PV Display	Alarm Indicator Lamps	READY Lamp		PV	Alarm Output	Monitor Output	
Undefined	Undefined	Undefined	CPU failure	Undefined	Undefined	Undefined	Failure. Submit request for us to repair.
OFF	OFF	OFF	Power failure	None (0%)	OFF	0% or less	
Err blinks	OFF	Blinking	RAM error	None (0%)	OFF	0% or less	
	AL2 blinking	Blinking	ROM error	None (0%)	OFF	0% or less	
PEr	Normal	Normal	Parameter error	Normal	Normal	Normal	Check all parameters.
SEr	Normal	Normal	EPP sum error	Normal	Normal	Normal	

### Possible Errors Occurring during Operations

The following describes errors that may occur during operations.

Error Indication			Description of Error	Status			Remedy
PV Display	Alarm Indicator Lamps	READY Lamp		PV	Alarm Output	Monitor Output	
Err blinks	AL1 lights	Normal	EEPROM error	None (0%)	OFF	0% or less	Failure. Submit request for us to repair.
ooo	Normal	Normal	Input exceeding high limit	110% of the measured range	Normal	106% or more of the output range	Check input.
uuu	Normal	Normal	Input falling below low limit	-10% of the measured range	Normal	-6% or less of the output range	Check input.
bo	Normal	Normal	Burnout	110% or -10% of the measured range	Normal	106% or more or -6% or less of the output range	Check input.
Decimal point blinks	Normal	Normal	Communication error	Normal	Normal	Normal	Press any key, or if normal communication is made, a communication error will be cleared.

## 14. MAIN SPECIFICATIONS

### Model and Suffix Codes

Model	Suffix Codes	Description
MVRK	- 0 0 □ □ □ □ □ / □	Digital Limit Alarm (RTD Input Type)
Type	-0	General use type
	0	Always 0
Power Supply	3	24 V DC±10%
	6	100-240 V AC/DC (Operating range: 85 to 264 V AC/DC)
Input Signal	-U	RTD input
	-Z	Custom order
Output Signal	1	Alarm output (transfer contact [1a1b]), 2 points
	2	Alarm output (NO contact), 4 points
Monitor Output	6	1 to 5 V DC
	A	4 to 20 mA DC
	P	Communication function (RS-485)
	N	No monitor output
Burnout	U	UP
	D	DOWN
	N	OFF (No burnout)
Optional Specification	/SN	Without socket

### Input and Display

Number of inputs: 1 point

Input signal: Set the measured input range within the instrument input range. (Refer to Section 7.1.)

Input resistance: 1 MΩ (4 kΩ during power off)

Allowable leadwire resistance:  $[\text{Input span (}^\circ\text{C)} \times 0.4 (\Omega)]$  or 10 Ω per leadwire, equal or less than whichever is smaller. (Make the resistance of each wire the same.) However, when used with BARD-700, this value can be added to the BARD internal resistance.

Detective current: Approx. 0.5 mA

Maximum allowable input: ±4 V DC

PV (measured value) display: 4-digit, 7-segment, red/green LED, character height of 13.5 mm

Data display: 4-digit, 7-segment, green LED, character height of 9 mm

Alarm indicator lamp: 2 orange LEDs for 2 points of alarms or 4 orange LEDs for 4 points of alarms. Lights up if an alarm occurs.

Economical mode: Turns off the indicating LED if no keystroke is made within the set time.

Setting range: 0 (does not go off) or 1 to 60 minutes

Active color PV display (PV display color changing function): This function changes the PV display color from green to red or from red to green according to the set PV display color mode shown below.

[PV display color mode to be set]

Link to alarm 1: Links to alarm 1.

Link to alarm 1 and alarm 2: Links to alarm 1 and alarm 2.

Link to alarm 1 to alarm 4 (only for 4 points of alarms): Links to alarm 1 to alarm 4.

SP deviation: Changes the PV display color according to whether measured value is less than SP deviation high limit or SP deviation high limit or more; whether measured value is more than SP deviation low limit or SP deviation low limit or less.

PV limit: Changes the PV display color according to whether measured value is less than measured range high limit or measured range high limit or more; whether measured value is more than measured range low limit or measured range low limit or less.

Fixed color: Fixes PV display color in green or red.

### Output

Signal type: Relay contact

Number of outputs: 2 points of contact outputs (transfer contact [1a1b]) or 4 points of contact outputs (NO contact)

Contact rating: 120 V AC/1 A, 220 V AC/0.5 A (resistance load)  
30 V DC/1 A, 120 V DC/0.1 A (resistance load)

Alarm action:

Alarm action	Relay action
PV high-limit alarm	Energized or de-energized under normal condition
PV low-limit alarm	Energized or de-energized under normal condition
Deviation high-limit alarm	Energized or de-energized under normal condition
Deviation low-limit alarm	Energized or de-energized under normal condition
Deviation high and low-limit alarm	De-energized under normal condition
Deviation within high and low-limit alarm	De-energized under normal condition

Alarm setting range: Within the input range

Setting resolution: 1 digit (0.1°C)

Setpoint setting: Virtual setpoint when the deviation alarm occurs

Setting range: Within the input range

Setting resolution: 1 digit (0.1°C)

Hysteresis setting range: The value resulting from adding a hysteresis value to an alarm setpoint should be within the set input range.

Setting resolution: 1 digit (0.1°C)

Alarm ON delay setting: Condition monitoring time from the establishment of alarm conditions to its output

Setting range: 0 to 999 seconds

Setting resolution: 1 second (However, about 0.2 second is to be added to the set time to prevent wrong operation.)

Alarm OFF delay setting: Condition monitoring time from the establishment of return-to-normal conditions to its output

Setting range: 0 to 999 seconds

Setting resolution: 1 second (However, about 0.2 second is to be added to the set time to prevent wrong operation.)

### Monitor Output

#### Analog Output

Output signal: 1 to 5 V DC or 4 to 20 mA DC

Allowable load resistance: 2 kΩ or more for 1 to 5 V DC  
350 Ω or less for 4 to 20 mA DC

Output variable range: -6 to +106%

Output scaling: Set any value within the measured input range. (Set the value so that the input range corresponding to the output scaling is 10°C or more.)

Output accuracy: ±0.1% of output span

However, the accuracy is limited in the following cases according to the output scaling setting.

When the input range corresponding to the output scaling converted into resistance is less than 130 Ω in the instrument input range H:

$$\text{Accuracy} = \frac{\pm 0.1 (\%) \times 130 (\Omega)}{\text{Input range converted into resistance } (\Omega)} (\%)$$

When the input range corresponding to the output scaling converted into resistance is less than 38.6 Ω in the instrument input range M:

$$\text{Accuracy} = \frac{\pm 0.1 (\%) \times 38.6 (\Omega)}{\text{Input range converted into resistance } (\Omega)} (\%)$$

#### Communication Output (RS-485)

The MVRK can be connected to a personal computer, graphic panel, Yokogawa's programmable controller FA-M3 or programmable controllers of other manufacturers.

Standards: EIA RS-485

Maximum number of connectable units: 31 units

Maximum communication distance: 1200 m

Communication method: 2-wire half duplex, start-stop synchronization, non-procedural

Baud rate: 1200, 2400, 4800 or 9600 bps

Data length: 8 or 7 bits

Stop bit: 1 or 2 bits

Parity: Even, odd or none

Communication protocol: PC link, PC link with SUM, MODBUS ASCII, MODBUS RTU or Ladder

PC link communication: Communication protocol with a personal computer, graphic panel or UT link module of FA-M3

MODBUS communication: Communication protocol with a personal computer (SCADA).

Ladder communication: Communication protocol with ladder communication module of FA-M3 and programmable controller of other manufacturers.

### Standard Performance

Input display accuracy: ±0.1%±1 digit of instrument input range span

Alarm action point setting accuracy: ±0.1%±1 digit of instrument input range span

Response speed: 500 ms (Time to alarm output when the input change is 10 to 90% and alarm setpoint is 50%. When the alarm delay setting and hysteresis are minimum.)

Burnout: UP, DOWN or OFF

Burnout time: 60 seconds or less

Action: High-limit alarm output for UP, Low-limit alarm output for DOWN

Insulation resistance: 100 MΩ/500 V DC between inputs, alarm outputs, power supply and monitor output mutually.

Withstand voltage: 2000 V AC/minute between inputs, (alarm outputs 1, 2, 3 and 4), monitor output and power supply mutually.

However, the following is excluded.

1000 V AC/minute between (alarm outputs 1 and 4) and (alarm outputs 2 and 3) and between inputs and monitor output.

(For 2 points of alarms, alarm outputs 3 and 4 are excluded.)

Power supply voltage: 24 V DC±10%, 100-240 V AC/DC (-15%, +10%) 50/60Hz

Power consumption: 24 V DC 2.7 W, 110 V DC 2.5 W, 100 V AC 4.2 VA,  
200 V AC 5.4 VA

Effect of power supply fluctuation: ±0.1% of span or less for the fluctuations within the allowable range of each power supply specification

Effect of ambient temperature change: ±0.2% of span or less for a temperature change of 10°C

Effect of leadwire resistance change: ±0.2°C or less for a change of 10 Ω/leadwire

### Mounting, Appearance and Environmental Conditions

Construction: Plug-in type

Material: Casing; ABS resin (black), UL94 V-0

Socket; Modified polyphenylene oxide resin, including glass fiber (black), UL94-V1

Mounting method: Wall or DIN rail mounting

Connection method: M3.5 screw terminal for input/output and power supply

3-pin 2-piece connector for monitor output

External dimensions: 51 (W)×86.5 (H)×133 (D) mm (including a socket)

Weight: Main unit; approx. 270 g

Socket; approx. 80 g

Operating temperature range: 0 to 50°C

Operating humidity range: 5 to 90% RH (no condensation)

Operating conditions: Avoid installation in such environments as corrosive gas like sulfide hydrogen, dust, sea breeze and direct sunlight.

### External Dimensions

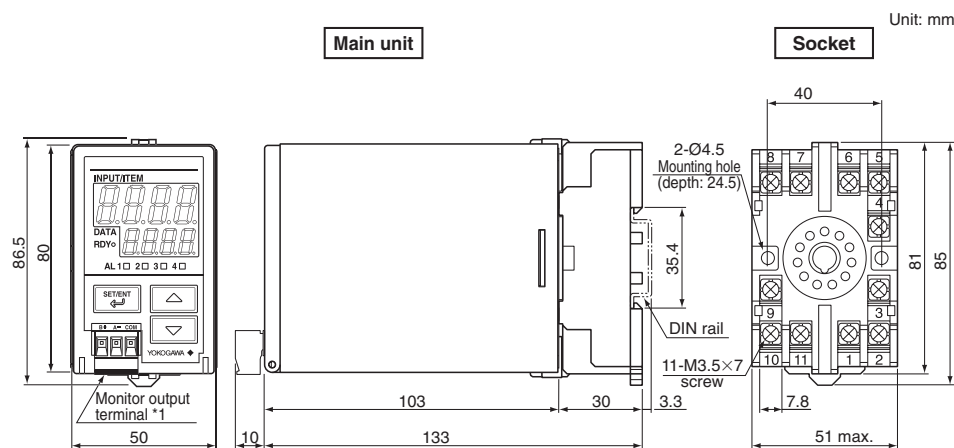

\*1 To be added when the monitor output is specified.