

DLM2000 Series
Digital Oscilloscope
Mixed Signal Oscilloscope
OPERATION GUIDE

Product Registration

Thank you for purchasing YOKOGAWA products.

YOKOGAWA provides registered users with a variety of information and services. Please allow us to serve you best by completing the product registration form accessible from our website.

<http://tmi.yokogawa.com/>

Thank you for purchasing the DLM2000 Series Digital Oscilloscope/Mixed Signal Oscilloscope. This manual contains useful information about the handling precautions and basic operations of the DLM2000. To ensure correct use, please read this manual thoroughly before beginning operation. After reading the manual, keep it in a convenient location for quick reference whenever a question arises during operation.

List of Manuals

The following manuals, including this one, are provided as manuals for the DLM2000. Read them along with this manual.

Manual Title	Manual No.	Description
DLM2000 Series Digital Oscilloscope Mixed Signal Oscilloscope Features Guide	IM 710105-01E	The supplied CD contains the PDF file of this manual. The manual explains the DLM2000 features.
DLM2000 Series Digital Oscilloscope Mixed Signal Oscilloscope User's Manual	IM 710105-02E	The supplied CD contains the PDF file of this manual. The manual explains how to operate the DLM2000.
DLM2000 Series Digital Oscilloscope Mixed Signal Oscilloscope Operation Guide	IM 710105-03E	This manual. It explains the handling precautions and basic operations of the DLM2000.
DLM2000 Series Digital Oscilloscope Mixed Signal Oscilloscope Communication Interface User's Manual	IM 710105-17E	The supplied CD contains the PDF file of this manual. The manual explains the DLM2000 communication interface features and instructions on how to use them.
DLM2000 Series Digital Oscilloscope Mixed Signal Oscilloscope	IM 710105-92	Document for China

The "E" in the manual number is the language code.

Contact information of Yokogawa offices worldwide is provided on the following sheet.

Document No.	Description
PIM 113-01Z2	List of worldwide contacts

Notes

- The contents of this manual are subject to change without prior notice as a result of continuing improvements to the instrument's performance and functions. The figures given in this manual may differ from the actual screen.
- Every effort has been made in the preparation of this manual to ensure the accuracy of its contents. However, should you have any questions or find any errors, please contact your nearest YOKOGAWA dealer.
- Copying or reproducing all or any part of the contents of this manual without the permission of YOKOGAWA is strictly prohibited.
- The TCP/IP software of this product and the documents concerning it have been developed/created by YOKOGAWA based on the BSD Networking Software, Release 1 that has been licensed from the Regents of the University of California.

Trademarks

- Microsoft, Internet Explorer, MS-DOS, Windows, Windows 7, Windows 8, Windows 8.1, and Windows 10 are either registered trademarks or trademarks of Microsoft Corporation in the United States and/or other countries.
- Adobe and Acrobat are either registered trademarks or trademarks of Adobe Systems Incorporated.
- DLM is a registered trademark of Yokogawa Electric Corporation.
- In this manual, the ® and TM symbols do not accompany their respective registered trademark or trademark names.
- Other company and product names are registered trademarks or trademarks of their respective holders.

Disposing of YOKOGAWA Products

When disposing of YOKOGAWA products, follow the laws and ordinances of the country or region where the product will be disposed of.

Revisions

- 1st Edition: November 2008
- 2nd Edition: November 2008
- 3rd Edition: March 2009
- 4th Edition: July 2009
- 5th Edition: February 2010
- 6th Edition: April 2011
- 7th Edition: July 2011
- 8th Edition: August 2013
- 9th Edition: December 2013
- 10th Edition: August 2014
- 11th Edition: May 2015
- 12th Edition: January 2016
- 13th Edition: October 2016
- 14th Edition: October 2017

Checking the Contents of the Package

Unpack the box and check the contents before operating the instrument. If some of the contents are not correct or missing or if there is physical damage, contact the dealer from whom you purchased them.

DLM2000

Check that the product that you received is what you ordered by referring to the model name and suffix code given on the name plate on the rear panel.

MODEL	SUFFIX ¹	Specifications
710105		DLM2022 Digital Oscilloscope 2 channels, 200 MHz
710110		DLM2024 Mixed Signal Oscilloscope 4 channels+ 8-bit switchable logic, 200 MHz
710115		DLM2032 Digital Oscilloscope 2 channels, 350 MHz
710120		DLM2034 Mixed Signal Oscilloscope 4 channels + 8-bit switchable logic, 350 MHz,
710125		DLM2052 Digital Oscilloscope 2 channels, 500 MHz,
710130		DLM2054 Mixed Signal Oscilloscope 4 channels + 8-bit switchable logic, 500 MHz,
Power cord ²	-D	UL/CSA Standard power cord, Maximum rated voltage: 125 V
	-F	VDE Standard Power Cord, Maximum rated voltage: 250 V
	-Q	BS Standard Power Cord, Maximum rated voltage: 250 V
	-R	AS Standard Power Cord, Maximum rated voltage: 250 V
	-H	GB Standard Power Cord, Maximum rated voltage: 250 V
	-N	NBR Standard power cord, Maximum rated voltage: 250 V
Language	-HJ	Japanese
(One option	-HE	English
can be selected	-HC	Chinese
for the factory	-HG	German
default message	-HF	French
language and	-HK	Korean
panel sheet	-HL	Italian
language)	-HS	Spanish
Options	/LN	No switchable logic input (4ch model only)
	/B5	Built-in printer
	/M1S	Memory expansion to 6.25M/25M/62.5M points (2ch model only)
	/M1	Memory expansion to 6.25M/25M/62.5M points (4ch model only)
	/M2	Memory expansion to 12.5M/62.5M/125M points (4ch model only)
	/M3	Memory expansion to 25M/125M/250M points (4ch model only)
	/P2	Rear panel probe power (2 terminals) (2ch model only)
	/P4	Rear panel probe power (4 terminals) (4ch model only)
	/C1	GP-IB interface
	/C10	Ethernet interface
	/C11	GP-IB + Ethernet interface
	/C8	1.8 GB internal storage
	/C9	7.2 GB internal storage
	/G2	User-defined computation (4ch model only)
	/G3	Power supply analysis (4ch model only)
	/G4	Power supply analysis (includes User-defined computation, 4ch model only)
	/F1	UART trigger and analysis (4ch model only)
	/F2	I ² C + SPI trigger and analysis (4ch model only)
	/F3	UART + I ² C + SPI trigger and analysis (4ch model only)
	/F4	CAN + LIN trigger and analysis + CXPI analysis (4ch model only)
	/F5	FlexRay trigger and analysis (4ch model only)
	/F6	CAN + LIN + FlexRay trigger and analysis + CXPI analysis (4ch model only)
	/F7	CAN + CAN FD + LIN trigger and analysis + CXPI analysis (4ch model only)
	/F8	CAN + CAN FD + LIN + FlexRay trigger and analysis + CXPI analysis (4ch model only)
	/F9	SENT analysis (4ch model only)

Checking the Contents of the Package

MODEL	SUFFIX ¹	Specifications
	/F10	PSI5 analysis (4ch model only)
	/F11	SENT + PSI5 analysis (4ch model only)
	/EX22	Attach two 701946 probes (2ch, 200 MHz model only)
	/EX24	Attach four 701946 probes (4ch, 200 MHz model only)
	/EX52	Attach two 701946 probes (2ch, 350/500 MHz model only)
	/EX54	Attach four 701946 probes (4ch, 350/500 MHz model only)

- 1 For products whose suffix code contains "Z," an exclusive manual may be included. Please read it along with the standard manual.
- 2 Make sure that the attached power cord meets the designated standards of the country and area that you are using it in.

Note

The SUFFIX (suffix code) inscribed in the name plate on the DLM2000 case indicates the installed options at the time of factory shipment. After you add options through additional option licenses, check the options on the DLM2000 overview screen.*

* For details on additional option licenses, see "Overview (Overview)" in chapter 22, "Other Features" of the features guide, IM 710105-01E.

NO. (Instrument Number)

When contacting the dealer from which you purchased the instrument, please give them the instrument number.

Standard Accessories

The standard accessories below are supplied with the instrument. Check that all contents are present and that they are undamaged.

Item	Model or Part No.	Quantity	Specifications and Notes
Power cord ¹	A1006WD A1009WD A1054WD A1024WD A1064WD A1088WD	1	UL/CSA Standard VDE Standard BS Standard AS Standard GB Standard NBR standard
Panel sheet	See the next page.	1	Japanese, Chinese, German, French, Korean, Italian, or Spanish
500-MHz passive probe ²	701939	4 (2)	The 710120 and 710130 come with four probes, and the 710115 and 710125 come with two probes.
200-MHz passive probe ³	701938	4 (2)	The 710110 comes with four probes, and the 710105 comes with two probes.
Rubber feet	B9989EX	1	—
Soft case	B8059GG	1	—
Printer roll paper ⁴	B9988AE	1	—
Front cover	B8059EP	1	—
Manuals			
Printed manuals	IM 710105-03E IM 710105-92 PIM 113-01Z2	1 1 1	Operation Guide (this guide) Document for China List of worldwide contacts
Manual CD	B8059RZ	1	Contains PDFs of the user's manuals (For the types of manuals that CD contains, see the next page.)

Standard accessories are not covered by warranty of this instrument.

Power cord (one cord that matches the suffix code is included)¹

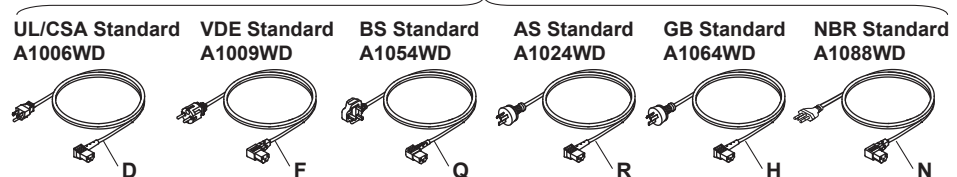

Checking the Contents of the Package

Panel Sheet

One of the following:
B8059GA(Japanese HJ)
B8059GB(Chinese HC)
B8059GC(German HG)
B8059GD(French HF)
B8059GE(Korea HK)
B8059GF(Italian HL)
B8059GJ(Spanish HS)

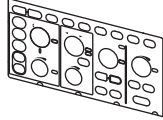

Printer roll paper⁴
B9988AE 1 roll



500-MHz passive probe²

701939 4 probes(710120,710130)
 2 probes(710115,710125)

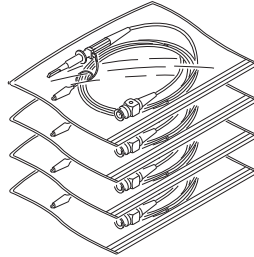

Front panel protection cover
B8059EP

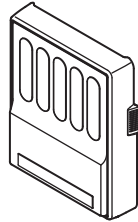

200-MHz passive probe³

701938 4 probes(710110)
 2 probes(710105)

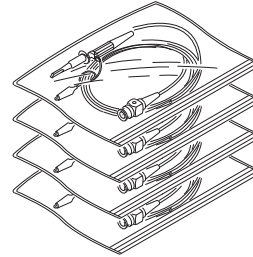

Manuals

• Printed manuals

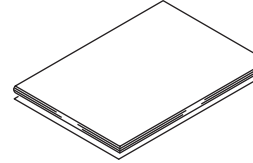

Rubber feet
B9989EX



Soft case
B8059GG

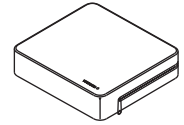

• Manual CD



- 1 Make sure that the attached power cord meets the designated standards of the country and area that you are using it in.
- 2 On models with the /EX52 or /EX54 option, 701946 passive probes are provided in place of 701939 passive probes.
- 3 On models with the /EX22 or /EX24 option, 701946 passive probes are provided in place of 701938 passive probes.
- 4 When using the optional built-in printer (/B5)

Manual CD

The English folder in the manual CD contains the PDF files shown below. The CD also contains Japanese manuals.

File Name	Manual Title	Manual No.
Communication Interface.pdf	DLM2000 Series Digital Oscilloscope Mixed Signal Oscilloscope Communication Interface User's Manual	IM 710105-17E
Features Guide&Users Manual.pdf	DLM2000 Series Digital Oscilloscope Mixed Signal Oscilloscope Features Guide	IM 710105-01E
	DLM2000 Series Digital Oscilloscope Mixed Signal Oscilloscope User's Manual	IM 710105-02E

To view the PDF files above, you need Adobe Reader.

WARNING

Never play this manual CD, which contains the user's manuals, in an audio CD player. Doing so may cause loss of hearing or speaker damage due to the large sounds that may be produced.

French

AVERTISSEMENT

Ce CD contient les manuels d'utilisation. Ne jamais insérer ce CD dans un lecteur de CD audio. Cela pourrait entraîner une perte d'audition ou l'endommagement des enceintes en raison du volume potentiellement élevé des sons produits.

Optional Accessories (Sold Separately)

The optional accessories below are available for purchase separately. For information and ordering, contact your nearest YOKOGAWA dealer.

- Use the accessories specified in this manual. Moreover, use the accessories of this product only with Yokogawa products that specify them as accessories.
- Use the accessories of this product within the rated range of each accessory. When using several accessories together, use them within the specification range of the accessory with the lowest rating.

Item	Model/ Part No.	Min. Q'ty	Specifications	Manual No.
PBDH1000 differential probe with YOKOGAWA probe interface	701924	1	DC to 1-GHz bandwidth, 1 M Ω , \pm 35 V maximum	IM 701924-01E
PBDH0150 differential probe with YOKOGAWA probe interface	701927	1	DC to 150-MHz bandwidth, \pm 1400 V maximum	IM 701927-01EN
PBC100 current probe with YOKOGAWA probe interface	701928	1	DC to 100-MHz bandwidth, 30 Arms	IM 701928-01E
PBC050 current probe with YOKOGAWA probe interface	701929	1	DC to 50-MHz bandwidth, 30 Arms	
Passive probe	701938	1	DC to 200-MHz bandwidth, 10 M Ω	IM 701938-01E
	701939	1	DC to 500-MHz bandwidth, 10 M Ω	IM 701939-01E
Miniature Passive Probe	701946	1	DC to 500-MHz bandwidth, 10 M Ω	IM 701946-01EN
Passive probe (wide temperature range)	702906	1	DC to 200 MHz bandwidth, 10 M Ω , operating temperature range: -40°C to +85°C (excluding the phase adjustment side)	IM 702906-01EN
PBL100 logic probe	701988	1	100-MHz toggle frequency, 1 M Ω	IM 701988-01E
PBL250 logic probe	701989	1	250-MHz toggle frequency, 100 k Ω	IM 701989-01E
100:1 high-voltage passive probe	701944	1	DC to 400-MHz bandwidth, 1000 Vrms, 1.2 m in length	IM 701944-01E
	701945	1	DC to 250-MHz bandwidth, 1000 Vrms, 3 m in length	
FET probe *	700939	1	900-MHz bandwidth, 2.5 M Ω , 1.8 pF	IM 700939-01E
Differential probe *	700924	1	DC to 100-MHz bandwidth, \pm 1400 V maximum	IM 700924-01E
	700925	1	DC to 15-MHz bandwidth, \pm 500 V maximum	IM 700925-01E
	701920	1	DC to 500-MHz bandwidth, \pm 30 V maximum (common-mode input)	IM 701920-01E
	701921	1	DC to 100-MHz bandwidth, \pm 700 V maximum	IM 701921-01E
	701922	1	DC to 200-MHz bandwidth, \pm 60 V maximum (common-mode input)	IM 701922-01E
	701926	1	DC to 50-MHz bandwidth, \pm 7000 V maximum (common-mode input)	IM 701926-01E
	701917	1	DC to 50 MHz bandwidth, 5 Arms	IM 701917-01EN
Current probe *	701918	1	DC to 120 MHz bandwidth, 5 Arms	IM 701917-01EN
	701930	1	DC to 10-MHz bandwidth, 150 Arms	IM 701930-01E
	701931	1	DC to 2-MHz bandwidth, 500 Arms	IM 701931-01E
	701932	1	DC to 100-MHz bandwidth, 30 Arms	IM 701932-01E
	701933	1	DC to 50-MHz bandwidth, 30 Arms	IM 701933-01E
PBL500 5 GHz low capacitance probe	701974	1	—	IM 701974-01E
Deskew signal source	701936	1	Approx. 0 to 5 V, approx. 0 to 100 mA, approx. 0 to 1 A, approx. 15 kHz	IM 701936-01EN
Mini clip adapter	700971	1 set	—	—
BNC adapter	700972	1	—	—
Logic probe accessory kit	701909	1 set	For the 701989	—
Probe stand	701919	1	—	IM 701919-01E
PCB adapter	366945	1 set	For 701939 passive probes	—
Solder-in adapter	366946	1 set	For 701939 passive probes	—

Checking the Contents of the Package

Item	Model/ Part No.	Min. Q'ty	Specifications	Manual No.
GO/NO-GO cable	366973	1	—	—
Soft carrying case	701964	1	For the DLM2000 series, three pockets	—

Optional accessories (sold separately) are not covered by warranty of this instrument.

* Used by connecting to a probe power terminal (/P2 or /P4 option) or a probe power supply (701934; sold separately).

Spare Parts (Sold Separately)

The spare parts below are available for purchase separately. Check that all contents are present and undamaged.

For information about ordering spare parts, contact your nearest YOKOGAWA dealer.

Name	Part No.	Minimum Q'ty	Note
Printer roll paper	B9988AE	10	Thermo-sensitive paper, 111 mm × 10 m

Safety Precautions

This product is designed to be used by a person with specialized knowledge.

This instrument is an IEC protection class I instrument (provided with terminal for protective earth grounding).

The general safety precautions described herein must be observed during all phases of operation. If the instrument is used in a manner not specified in this manual, the protection provided by the instrument may be impaired.

This manual is part of the product and contains important information. Store this manual in a safe place close to the instrument so that you can refer to it immediately. Keep this manual until you dispose of the instrument.

YOKOGAWA assumes no liability for the customer's failure to comply with these requirements.

The Following Symbols Are Used on This Instrument.



Warning: handle with care. Refer to the user's manual or service manual.

This symbol appears on dangerous locations on the instrument which require special instructions for proper handling or use. The same symbol appears in the corresponding place in the manual to identify those instructions.



Functional ground terminal (do not use this terminal as a protective ground terminal.)



Alternating current



Direct current



On (power)



Off (power)

French



Avertissement : À manipuler délicatement. Toujours se reporter aux manuels d'utilisation et d'entretien. Ce symbole a été apposé aux endroits dangereux de l'instrument pour lesquels des consignes spéciales d'utilisation ou de manipulation ont été émises. Le même symbole apparaît à l'endroit correspondant du manuel pour identifier les consignes qui s'y rapportent.



Borne de terre ou borne de terre fonctionnelle (ne pas utiliser cette borne comme prise de terre.)



Courant alternatif



Courant direct



Marche (alimentation)



Arrêt (alimentation)

Failure to comply with the precautions below could lead to injury or death or damage to the instrument.

WARNING**Use the Instrument Only for Its Intended Purpose**

This instrument is a waveform measuring device that monitors and measures electrical signals. Do not use this instrument for anything other than as a waveform measuring device.

Check the Physical Appearance

Do not use the instrument if there is a problem with its physical appearance.

Use the Correct Power Supply

Before connecting the power cord, ensure that the source voltage matches the rated supply voltage of the DLM2000 and that it is within the maximum rated voltage of the provided power cord.

Use the Correct Power Cord and Plug

To prevent the possibility of electric shock or fire, be sure to use the power cord supplied by YOKOGAWA. The main power plug must be plugged into an outlet with a protective earth terminal. Do not invalidate this protection by using an extension cord without protective earth grounding. Additionally, do not use the power cord supplied with this instrument with another instrument.

Connect the Protective Grounding Terminal

Make sure to connect the protective earth to prevent electric shock before turning on the power. The power cord that comes with the instrument is a three-prong type power cord. Connect the power cord to a properly grounded three-prong outlet.

Do Not Impair the Protective Grounding

Never cut off the internal or external protective earth wire or disconnect the wiring of the protective earth terminal. Doing so may result in electric shock or damage to the instrument.

Do Not Use When the Protection Functions Are Defective

Before using this instrument, check that the protection functions, such as the protective grounding and fuse, are working properly. If you suspect a defect, do not use the instrument.

Do Not Operate in an Explosive Atmosphere

Do not operate the instrument in the presence of flammable gasses or vapors. Doing so is extremely dangerous.

Do Not Remove the Covers or Disassemble or Alter the Instrument

Only qualified YOKOGAWA personnel may remove the covers and disassemble or alter the instrument. The inside of the instrument is dangerous because parts of it have high voltages.

Ground the Instrument before Making External Connections

Securely connect the protective grounding before connecting to the item under measurement or to an external control unit. Before touching a circuit, turn off its power and check that it has no voltage. To prevent the possibility of electric shock or an accident, connect the ground of the probe and input connector to the ground of the item being measured.

Measurement Category

The measurement category of the DLM2000 signal input terminals is Other (O). Do not use it to measure the main power supply or for Measurement Categories II, III, and IV.

Install or Use the Instrument in Appropriate Locations

- Do not install or use the instrument outdoors or in locations subject to rain or water.
- Install the instrument so that you can immediately remove the power cord if an abnormal or dangerous condition occurs.

Accessories

Use the accessories specified in this manual. Moreover, use the accessories of this product only with Yokogawa products that specify them as accessories. Do not use faulty accessories.

CAUTION

Operating Environment Limitations

This product is a Class A (for industrial environments) product. Operation of this product in a residential area may cause radio interference in which case the user will be required to correct the interference.

French

AVERTISSEMENT

Utiliser l'instrument aux seules fins pour lesquelles il est prévu

Cet instrument est un appareil de mesure de forme d'onde pour le contrôle et la mesure des signaux électriques. Ne pas utiliser cet instrument à d'autres fins que celles de mesure de forme d'onde.

Inspecter l'apparence physique

Ne pas utiliser l'instrument si son intégrité physique semble être compromise.

Vérifier l'alimentation

Avant de brancher le cordon d'alimentation, vérifier que la tension source correspond à la tension d'alimentation nominale du DLM2000 et qu'elle est compatible avec la tension nominale maximale du cordon d'alimentation.

Utiliser le cordon d'alimentation et la fiche adaptés

Pour éviter les risques de choc électrique ou d'incendie, utilisez le cordon d'alimentation fourni par YOKOGAWA. La fiche doit être branchée sur une prise secteur raccordée à la terre. En cas d'utilisation d'une rallonge, celle-ci doit être impérativement reliée à la terre. Par ailleurs, n'utilisez pas le cordon d'alimentation fourni pour cet instrument avec un autre appareil.

Brancher la prise de terre

Avant de mettre l'instrument sous tension, penser à brancher la prise de terre pour éviter tout choc électrique. Le cordon d'alimentation livré avec l'instrument est doté de trois broches. Brancher le cordon d'alimentation sur une prise de courant à trois plots et mise à la terre.

Ne pas entraver la mise à la terre de protection

Ne jamais neutraliser le fil de terre interne ou externe, ni débrancher la borne de mise à la terre. Cela pourrait entraîner un choc électrique ou endommager l'instrument.

Ne pas utiliser lorsque les fonctions de protection sont défectueuses

Avant d'utiliser l'instrument, vérifier que les fonctions de protection, telles que le raccordement à la terre et le fusible, fonctionnent correctement. En cas de dysfonctionnement possible, ne pas utiliser l'instrument.

Ne pas utiliser dans un environnement explosif

Ne pas utiliser l'instrument en présence de gaz ou de vapeurs inflammables. Cela pourrait être extrêmement dangereux.

Ne pas retirer le capot, ni démonter ou modifier l'instrument

Seul le personnel YOKOGAWA qualifié est habilité à retirer le capot et à démonter ou modifier l'instrument. Certains composants à l'intérieur de l'instrument sont à haute tension et par conséquent, représentent un danger.

Relier l'instrument à la terre avant de le brancher sur des connexions externes

Toujours relier l'instrument à la terre avant de le brancher aux appareils à mesurer ou à une commande externe. Avant de toucher un circuit, mettre l'instrument hors tension et vérifier l'absence de tension. Pour éviter tout risque de choc électrique, brancher la terre de la sonde et du connecteur d'entrée sur la terre de l'appareil à mesurer.

Catégorie de mesure

La catégorie de mesure des terminaux d'entrée de signal du DLM2000 est Autre (O). Ne pas l'utiliser pour mesurer l'alimentation électrique, ni pour les catégories de mesure II, III et IV.

Installer et utiliser l'instrument aux emplacements appropriés

- Ne pas installer, ni utiliser l'instrument à l'extérieur ou dans des lieux exposés à la pluie ou à l'eau.
- Installer l'instrument de manière à pouvoir immédiatement le débrancher du secteur en cas de fonctionnement anormal ou dangereux.

Accessoires

Utiliser les accessoires spécifiés dans ce manuel. En outre, utiliser les accessoires de ce produit uniquement avec des produits Yokogawa pour lesquels ils sont spécifiés comme accessoires.

Ne pas utiliser d'accessoires défectueux.

ATTENTION

Limitations relatives à l'environnement opérationnel

Ce produit est un produit de classe A (pour environnements industriels). L'utilisation de ce produit dans un zone résidentielle peut entraîner une interférence radio que l'utilisateur sera tenu de rectifier.

Sales in Each Country or Region

Waste Electrical and Electronic Equipment



Waste Electrical and Electronic Equipment (WEEE), Directive

(This directive is valid only in the EU.)

■ This product complies with the WEEE directive marking requirement. This marking indicates that you must not discard this electrical/electronic product in domestic household waste.

Product Category

With reference to the equipment types in the WEEE directive, this product is classified as a “Monitoring and control instruments” product.

When disposing of products in the EU, contact your local Yokogawa Europe B.V. office. Do not dispose in domestic household waste.

EU Battery Directive



EU Battery Directive

(This directive is valid only in the EU.)

Batteries are included in this product. This marking indicates they shall be sorted out and collected as ordained in the EU battery directive.

Battery type: Lithium battery

You cannot replace batteries by yourself. When you need to replace batteries, contact your local Yokogawa Europe B.V. office.

Authorized Representative in the EEA

Yokogawa Europe B.V. is the authorized representative of Yokogawa Test & Measurement Corporation for this product in the EEA. To contact Yokogawa Europe B.V., see the separate list of worldwide contacts, PIM 113-01Z2.

How to Use This Manual

Structure of the Manual

This manual contains the five chapters and the appendix that are listed below.

Chapter Title	Description
1 Component Names and Functions	Introduces the DLM2000 components and their functions, and describes various screens.
2 Before You Start Measuring	Describes handling precautions, how to install the DLM2000, how to connect the DLM2000 to a power supply, how to turn the power switch on and off, how to install modules, how to connect probes, and so on.
3 Basic Operations	Describes how to use panel keys and the jog shuttle, how to enter characters, how to initialize the settings to their default values, how to perform auto setup, how to set the clock, and so on.
4 Operating the DLM2000	Using a probe compensation signal as an example, this chapter briefly explains how to display waveforms, adjust the vertical and horizontal scale, configure triggers, perform cursor measurements, zoom in on waveforms, print and save screen captures, and save waveforms.
5 Specifications	Summarizes the DLM2000 specifications in tables.
Appendix	See the reference documents for the relationship between the time axis setting, record length, and sample rate.

Symbols and Notation Used in This Manual

Safety Markings

The following markings are used in this manual.



Improper handling or use can lead to injury to the user or damage to the instrument. This symbol appears on the instrument to indicate that the user must refer to the user's manual for special instructions. The same symbol appears in the corresponding place in the user's manual to identify those instructions. In the manual, the symbol is used in conjunction with the word "WARNING" or "CAUTION."

WARNING

Calls attention to actions or conditions that could cause serious or fatal injury to the user, and precautions that can be taken to prevent such occurrences.

CAUTION

Calls attentions to actions or conditions that could cause light injury to the user or damage to the instrument or user's data, and precautions that can be taken to prevent such occurrences.

French

AVERTISSEMENT

Attire l'attention sur des gestes ou des conditions susceptibles de provoquer des blessures graves (voire mortelles), et sur les précautions de sécurité pouvant prévenir de tels accidents.

ATTENTION

Attire l'attention sur des gestes ou des conditions susceptibles de provoquer des blessures légères ou d'endommager l'instrument ou les données de l'utilisateur, et sur les précautions de sécurité susceptibles de prévenir de tels accidents.

Note

Calls attention to information that is important for proper operation of the instrument.

Contents

List of Manuals.....	i
Checking the Contents of the Package.....	iii
Safety Precautions.....	viii
Sales in Each Country or Region.....	xii
How to Use This Manual.....	xiii
Chapter 1 Component Names and Functions	
1.1 Front Panel and Rear Panel.....	1-1
1.2 Keys and Knobs	1-3
1.3 Screens	1-7
Chapter 2 Making Preparations for Measurements	
2.1 Handling Precautions	2-1
2.2 Installing the Instrument	2-3
⚠ 2.3 Connecting the Power	2-6
⚠ 2.4 Connecting the Probe.....	2-10
⚠ 2.5 Compensating the Probe (Phase Correction)	2-16
⚠ 2.6 Connecting Logic Probes	2-18
2.7 Attaching the Panel Sheet.....	2-21
⚠ 2.8 Loading Roll Paper into the Built-In Printer (Option)	2-22
Chapter 3 Basic Operations	
3.1 Key and Jog Shuttle Operations.....	3-1
3.2 Entering Values and Strings	3-3
3.3 Using USB Keyboards and Mouse Devices	3-5
3.4 Synchronizing the Clock	3-10
3.5 Performing Auto Setup	3-12
3.6 Resetting the DLM2000 to Its Factory Default Settings	3-14
3.7 Starting and Stopping Waveform Acquisition	3-15
3.8 Calibrating the DLM2000.....	3-16
3.9 Displaying Help	3-17
Chapter 4 Operating the DLM2000	
4.1 Applying Signals to Measure.....	4-1
4.2 Changing the Waveform Display Conditions	4-2
4.3 Changing the Trigger Settings.....	4-4
4.4 Measuring the Waveform	4-6
4.5 Zooming in on or out from the Waveform	4-7
4.6 Printing and Saving the Waveform	4-8

1

2

3

4

5

App

Chapter 5 Specifications

5.1 Signal Input Section 5-1
5.2 Triggering Section 5-3
5.3 Time Axis 5-7
5.4 Display 5-7
5.5 Features 5-7
5.6 Built-in Printer (/B5 Option) 5-15
5.7 Storage 5-15
5.8 USB for Peripherals 5-15
5.9 Auxiliary I/O Section 5-16
5.10 Computer Interface 5-17
5.11 General Specifications 5-18
5.12 External Dimensions 5-21

Appendix

Appendix 1 Relationship between the Time Axis Setting, Record Length, and Sample Rate..... App-1

1.1 Front Panel and Rear Panel

Front Panel

DLM2024, DLM2034, and DLM2054

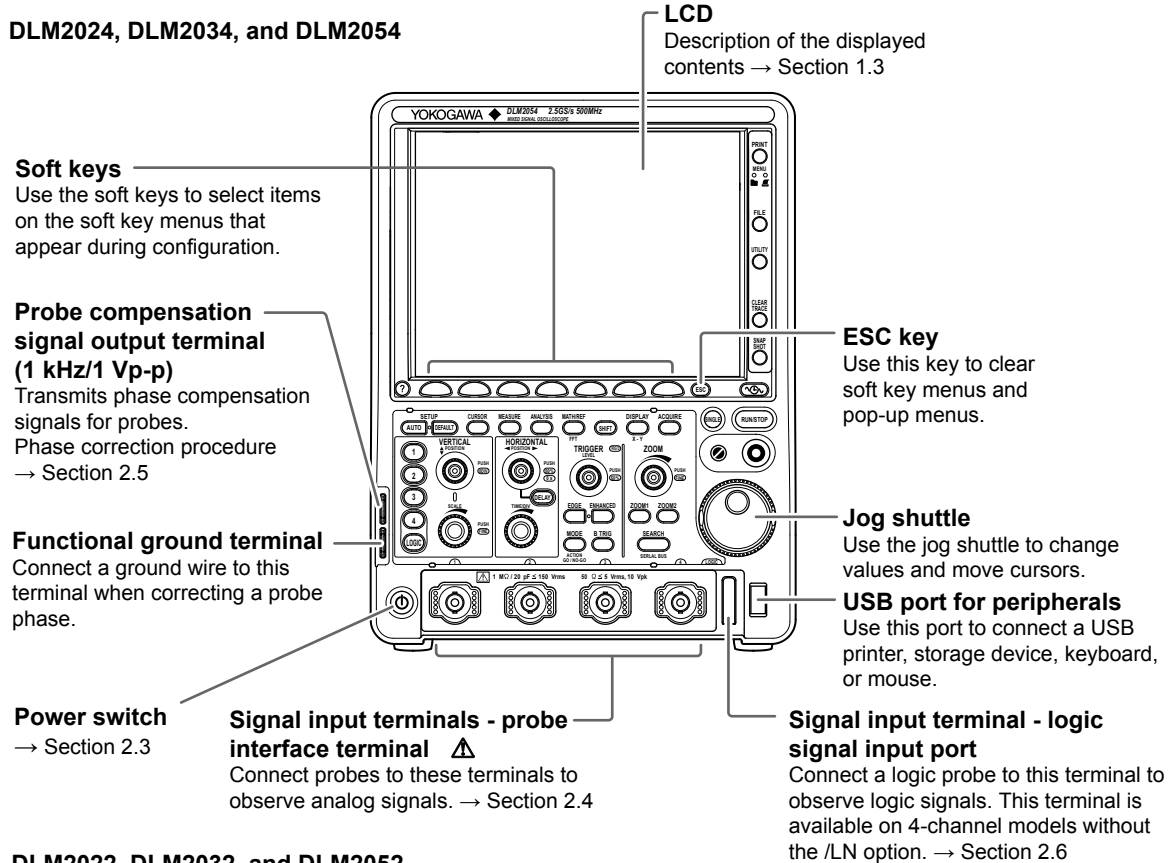

DLM2022, DLM2032, and DLM2052

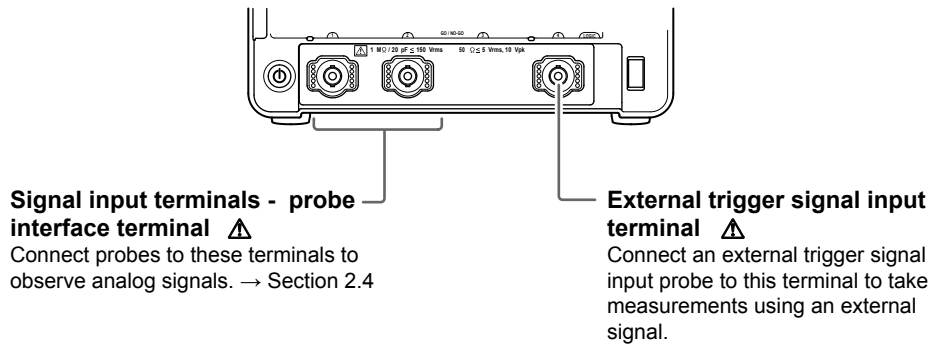

Rear Panel

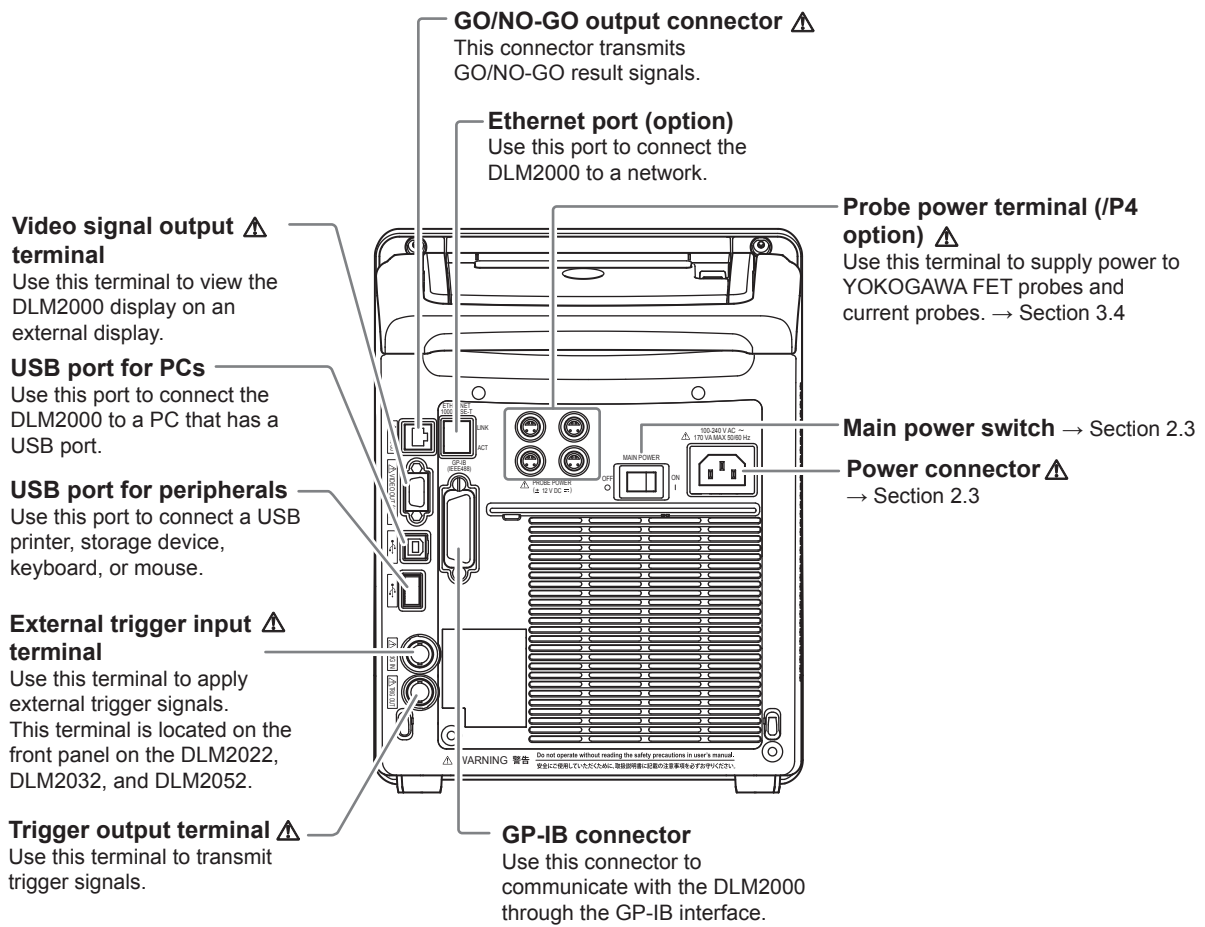

1.2 Keys and Knobs

Vertical Axis and Channels

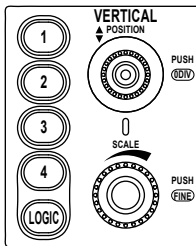

CH1 to CH4 Keys and LOGIC Key (On 4-channel models)

Displays a menu for turning analog signal input channels on and off, for expanding and reducing the vertical axis, and for setting the vertical position, coupling, probe type, offset voltage, bandwidth limit, linear scaling, and waveform labels. Also, press any of these keys to select which channel the SCALE or POSITION knob will control. Channel keys illuminate when the corresponding channel displays are on. And The LED between the SCALE and POSITION knobs illuminates in the color assigned to the selected channel (the color around the CH key).

Use the LOGIC key to configure the logic channel. At any given time, you can either use the CH4 analog signal input channel or the logic channel. If you press LOGIC, the logic channel is enabled. If you press CH4, the CH4 analog signal input channel is enabled. The key that corresponds to the enabled channel illuminates.

POSITION Knob

Use this knob to change the center position when you change the voltage range. Before you turn this knob, select the source waveform by pressing a key from CH1 to CH4 (or LOGIC). This knob has a push switch. You can press the knob to reset the position to 0.0 divisions. You can also use this knob on the logic channel.

SCALE Knob

Use this knob to set the vertical scale. Before you turn this knob, select the target waveform by pressing a key from CH1 to CH4 (or LOGIC). If you change the scale while signal acquisition is stopped, the waveform is expanded or reduced vertically. The setting actually takes effect when you restart signal acquisition.

This knob has a push switch. You can press the knob to switch the resolution. If you press the knob so that Fine illuminates, the resolution is set to fine mode.

If the target signal is a logic signal, you can expand the waveform by three vertical levels.

Horizontal Axis

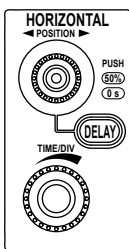

POSITION Knob

Use this knob to change the center position when you change the time-axis range. This knob has a push switch. You can press the knob to reset the position back to 50%.

DELAY Key

When you press the DELAY key, the key illuminates. Then you can set the trigger delay using the POSITION knob. You can reset the trigger delay to its default value (0 s) by pressing the POSITION knob when the DELAY key is illuminated.

TIME/DIV Knob

Use this knob to set the time-axis scale. If you change the scale while signal acquisition is stopped, the waveform is expanded or reduced horizontally. If you restart signal acquisition, the DLM2000 acquires signals using the new time-axis scale.

Triggering

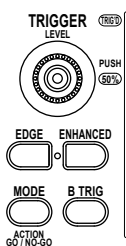

EDGE Key

Displays a menu for setting the edge trigger. When you press this key, the edge trigger is selected, and the key illuminates.

ENHANCED Key

Displays a menu for setting the enhanced trigger. When you press this key, the enhanced trigger is selected, and the key illuminates.

MODE Key and ACTION GO/NO-GO (SHIFT+MODE) Key

Displays a menu for selecting the trigger mode. Press SHIFT and then press MODE to display an action-on-trigger menu.

B TRIG Key

Use this key to set trigger combinations with the Edge or Enhanced trigger and to set the trigger B trigger type.

LEVEL Knob

Use this knob to set the trigger level. This knob has a push switch. You can press the knob to automatically set the trigger level to an appropriate level.

TRIG'D LED

Illuminates when the DLM2000 triggers.

Waveform Acquisition



ACQUIRE Key

Displays a menu for setting the signal acquisition mode.

RUN/STOP Key

Starts and stops signal acquisition according to the trigger mode. The key illuminates while the DLM2000 is acquiring signals.

SINGLE Key

Acquires one waveform. In Average mode, the DLM2000 acquires one waveform that has been obtained by linearly averaging waveforms for the specified number of times.

Zoom, Search, and Serial Bus

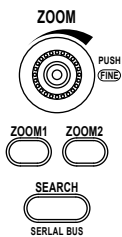

ZOOM1 and ZOOM2 Keys

Displays a waveform zoom display menu. When a waveform zoom display is on, the corresponding key illuminates. If ZOOM1 and ZOOM2 are both on, the ZOOM knob controls the magnification of the zoom waveform whose corresponding key is illuminated brightly.

ZOOM Knob

When a zoom display is on, you can turn this knob to set the magnification of the corresponding horizontal axis. Before turning this knob, press ZOOM1 or ZOOM2 to select the zoom waveform whose magnification you want to control. This knob has a push switch. You can press the knob to switch the resolution. If you press the knob so that Fine illuminates, the resolution is set to fine mode.

SEARCH Key

Displays a waveform search menu.

SHIFT+SEARCH (SERIAL BUS) Key

Press SHIFT and then press SEARCH to display a serial bus menu.

Analysis

CURSOR Key

Displays a menu for making cursor measurements.

MEASURE Key

Displays a menu for automatic measurement of waveform parameters and for statistical processing.

ANALYSIS Key

Displays a waveform histogram display and an optional power supply analysis menu.

MATH/REF Key

Use this key to configure waveform computation and reference waveforms.

SHIFT+MATH/REF (FFT) Key

Press SHIFT and then press MATH/REF to display an FFT menu.

Display

DISPLAY Key

Use this key to configure the display.

SHIFT+DISPLAY (X-Y) Key

Press SHIFT and then press DISPLAY to display an X-Y display menu.

Screen Capture Printing, Data Storage, History Waveforms, and Other Features

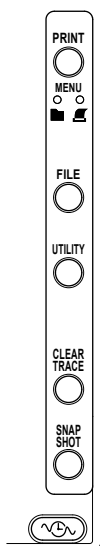

PRINT Key

Use this key to save and print screen capture data.

SHIFT+PRINT (MENU) Key

Displays a menu for printing screen captures to the built-in printer or a USB printer or displays a menu for saving screen capture data to a storage medium. An indicator illuminates to show which menu is selected.

FILE Key

Displays a menu for saving various data to the internal memory and USB memory, loading data that you have saved, and performing other file related tasks.

UTILITY Key

Displays a menu for calibrating the DLM2000, for LCD back light, for executing self-tests, and for configuring the network, the connection to the PC, the date and time, the menu language, the message language, the LCD back light, the offset cancel, the delay cancel, and the click sound.

You can also use this key to display system information (installed options and firmware version).

CLEAR TRACE Key

Clears the displayed waveforms. If you execute a clear trace operation during waveform acquisition, the DLM2000 clears all of the history waveforms that it has acquired and restarts waveform acquisition from the first acquisition.

SNAPSHOT Key

Retains the currently displayed waveforms on the screen in white (by default).

HISTORY (WAVEFORM) Key

Displays a menu for displaying and searching the history waveforms.

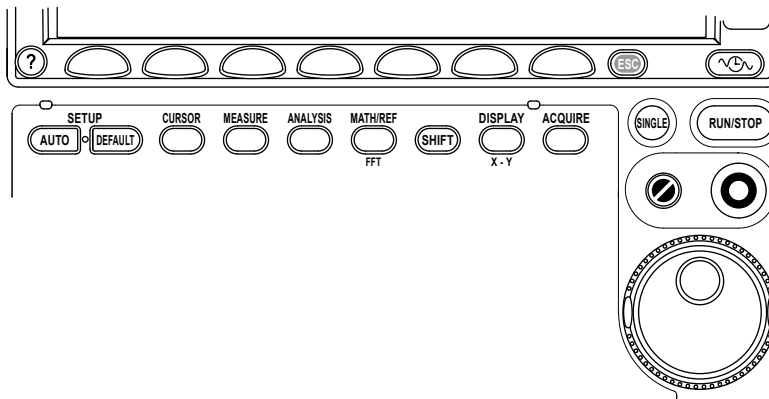

AUTO SETUP Key

Executes auto setup, which automatically configures the DLM2000 based on the input signals. The UNDO command, which can be used to revert the settings to their original values, appears in the menu.

DEFAULT SETUP Key

Initializes the DLM2000 settings to their factory default values. The UNDO command, which can be used to revert the settings to their original values, appears in the menu.

HELP (?) Key

Turns on and off the help window, which explains various features.

SHIFT Key

Press this key once to access the features that are written in purple below each key. The shift key illuminates when the keys are shifted. Press the key again to clear the shifted state.

Function Keys (F1 to F7)

Use these keys to select items that appear in the function key menu of the screen.

ESC Key

Use this key to clear the function key menu, close dialog boxes, and return to the menu level above the current one.

Jog Shuttle

When configuring various settings, use the jog shuttle to set values, move cursors, and select items. Turn the shuttle ring to vary the rate at which values change. The rate is set based on the shuttle ring angle.

RESET (⊘) Key

Resets the value to its default value.

SET (⊙) Key

Press this key to enter the menu item that you selected using the jog shuttle.

If there are two items on the jog shuttle setup menu, you can press the key to change the item that the jog shuttle controls.

Move the SET key left and right to move the cursor between numeric digits.

Move the SET key up and down to increase and decrease a value. You can change the setting on a dialog menu by moving the key up, down, left, and right.

Notes about the Operation of Knobs with Push Switches

The following knobs have push switches: SCALE, LEVEL, POSITION (vertical and horizontal), and ZOOM. Push the knobs straight. If you push a knob at an angle, it may not operate properly. If this happens, push the knob straight one more time.

CAUTION

Do not push the knob sideways with strong force. If you do, the knob may break.

French

ATTENTION

Ne pas enfoncer les boutons latéralement en employant une force excessive. Cela pourrait les endommager, voire les casser.

1.3 Screens

Normal Analog Signal Waveform Screen

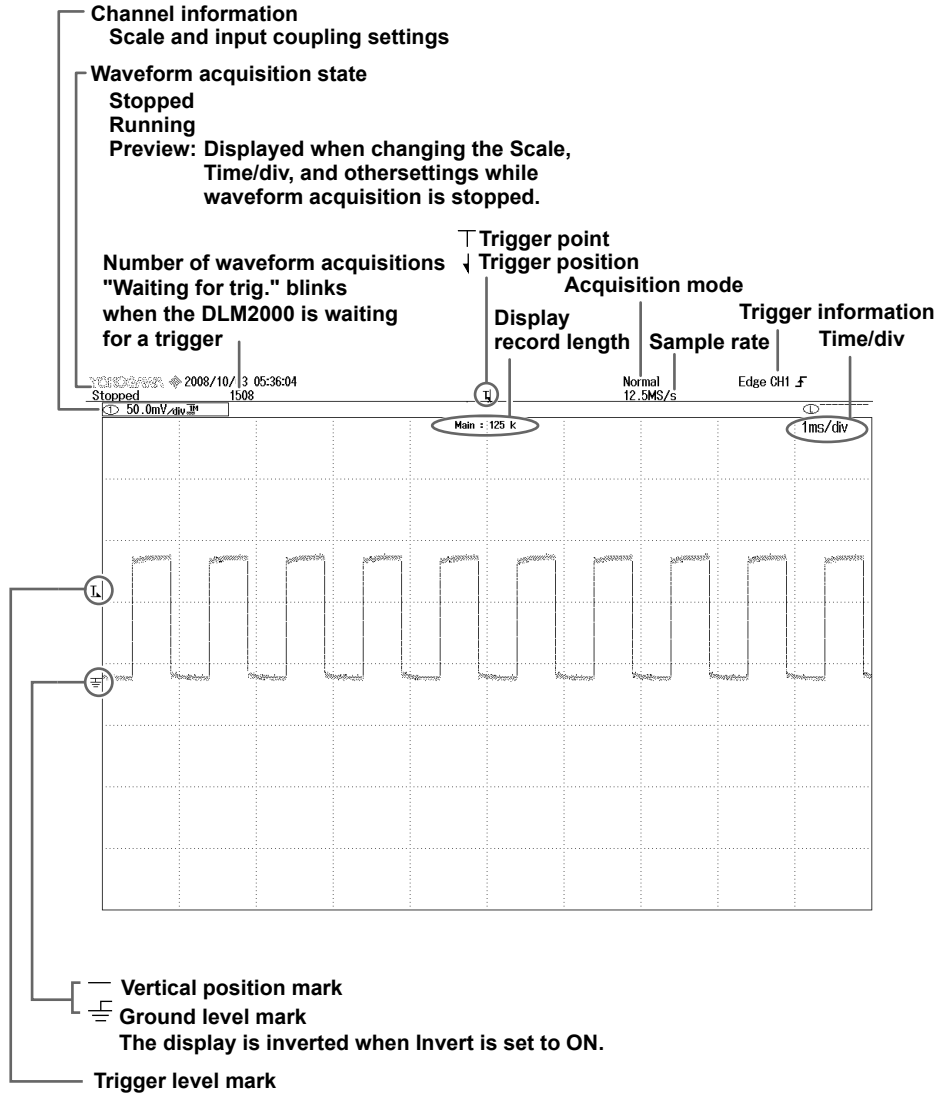

Logic Signal Waveform Screen (On 4-channel models)

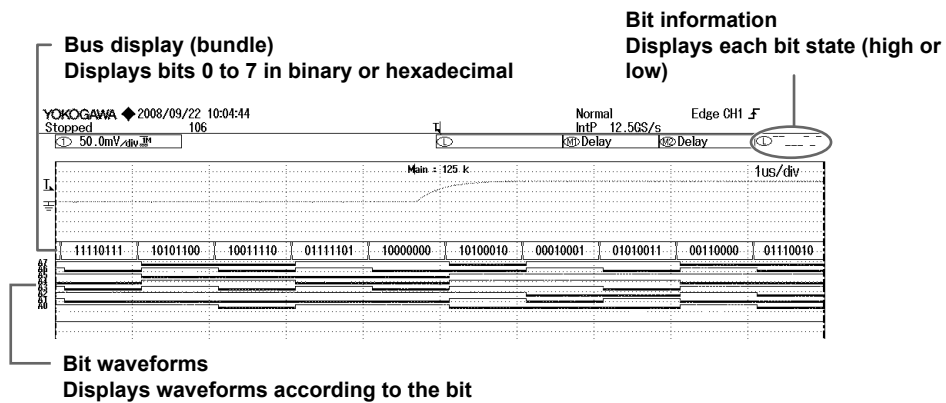

Screen Displaying Zoom Waveforms

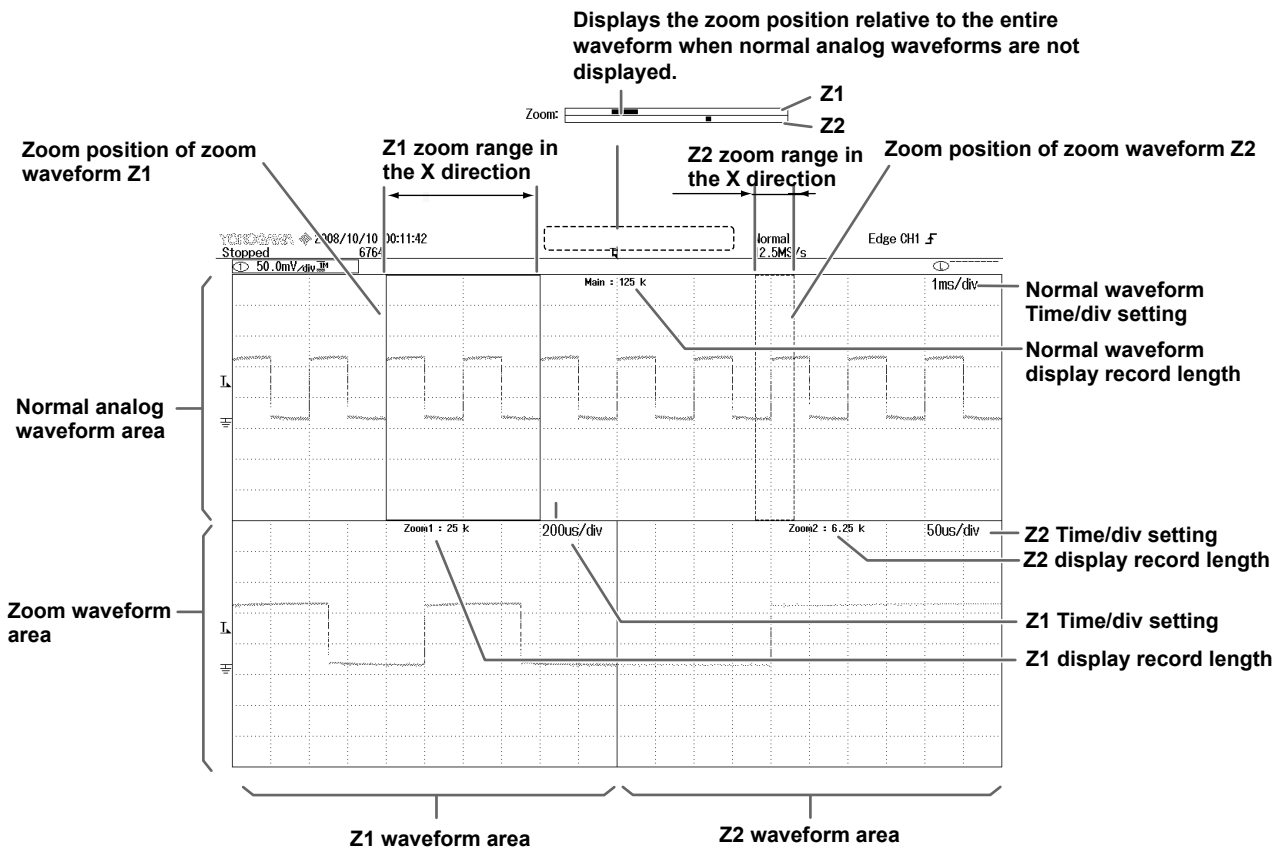

Screen Displaying Analysis Results

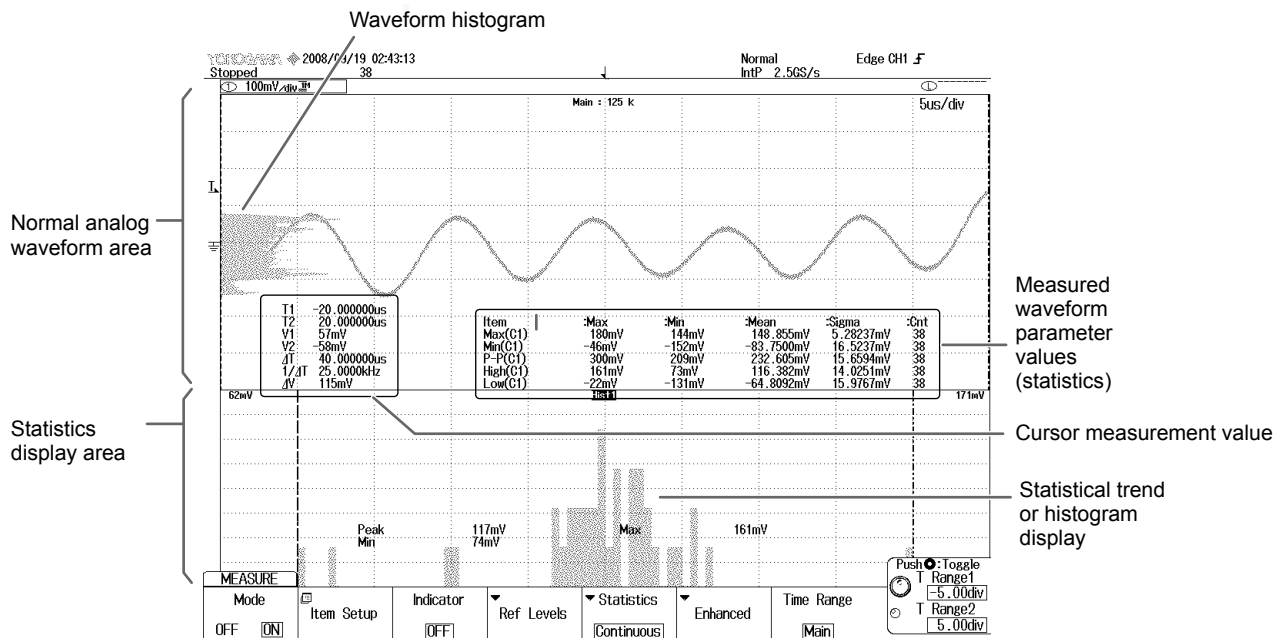

If the setup menu is not displayed, the setup menu display area shows measured waveform parameter values or cursor measurement values.

Hierarchical Display of Setup Menus

The higher-level setup menus are displayed using cascaded tags.

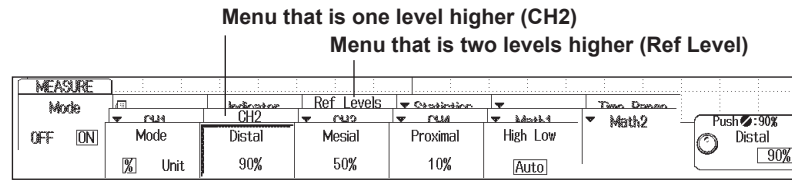

2.1 Handling Precautions

Safety Precautions

If you are using this instrument for the first time, make sure to thoroughly read the safety precautions given on pages viii to xi.

Do Not Remove the Case

Do not remove the case from the instrument. Some sections inside the instrument have high voltages and are extremely dangerous. For internal inspections or adjustments, contact your dealer.

Unplug If Abnormal Behavior Occurs

If you notice smoke or unusual odors coming from the instrument, immediately turn OFF the power and unplug the power cord. If such an irregularity occurs, contact your dealer.

Do Not Damage the Power Cord

Nothing should be placed on the power cord. The cord should be kept away from any heat sources. When unplugging the power cord from the outlet, never pull by the cord itself. Always hold and pull by the plug. If the power cord is damaged, contact your dealer for replacement. Refer to page iv for the part number when placing an order.

General Handling Precautions

Do Not Place Objects on Top of the Instrument

Never place other instruments or objects containing water on top of the instrument, otherwise a breakdown may occur.

Do Not Apply Shock to the Input Section

Shocks to the input connectors or probes may turn into electrical noise and enter the instrument via the signal lines.

Do Not Damage the LCD

Since the LCD screen is very vulnerable and can be easily scratched, do not allow any sharp objects near it. Also it should not be exposed to vibrations and shocks.

Unplug during Extended Non-Use

Unplug the power cord from the outlet.

2.1 Handling Precautions

When Carrying the Instrument

Remove the power cord and connecting cables. When carrying the instrument, either hold the handle or hold the instrument with both hands as shown in the figure below.

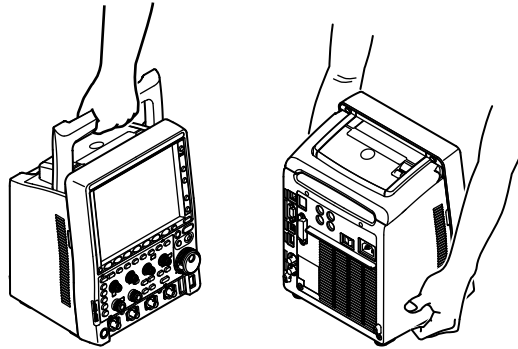

WARNING

- When you hold or put away the handle, be careful not to get your hand caught between the handle and the case.
- When you carry the instrument, be careful not to get your hand caught between the wall, installation surface, or other objects and the instrument.

French

AVERTISSEMENT

- Lorsque vous attrapez ou rabattez la poignée, veillez à ne pas vous coincer la main entre la poignée et l'instrument.
- Lorsque vous déplacez l'instrument, veillez à ne pas vous coincer la main entre l'instrument et le mur, la surface d'installation ou tout autre objet.

Cleaning

When cleaning the case or the operation panel, first remove the power cord from the AC outlet. Then, wipe with a dry, soft, clean cloth. Do not use chemical such as benzene or thinner. These can cause discoloring and deformation.

2.2 Installing the Instrument

WARNING

- Do not install the instrument outdoors or in locations subject to rain or water.
- Install the instrument so that you can immediately remove the power cord if an abnormal or dangerous condition occurs.

CAUTION

If you block the inlet holes on the left side or the outlet holes on the rear side of the DLM2000, the DLM2000 will become hot and may break down.

French

AVERTISSEMENT

- Ne pas installer l'instrument à l'extérieur ou dans des lieux exposés à la pluie ou à l'eau.
- Installer l'instrument de manière à pouvoir immédiatement le débrancher du secteur en cas de fonctionnement anormal ou dangereux.

ATTENTION

Si vous bloquez les orifices d'entrée gauches ou les orifices de sortie arrière du DLM2000, ce dernier surchauffe et risque de tomber en panne.

Installation Conditions

Install the instrument in a place that meets the following conditions.

Flat, Even Surface

Install the instrument with the correct orientation on a stable, horizontal surface. The recording quality of the printer may be hindered when the instrument is placed in an unstable or inclined place.

2.2 Installing the Instrument

Well-Ventilated Location

Inlet holes are located on the left of the instrument. There are also exhaust holes on the rear side. To prevent internal overheating, allow for enough space around the instrument (see the figure below) and do not block the inlet and exhaust holes.

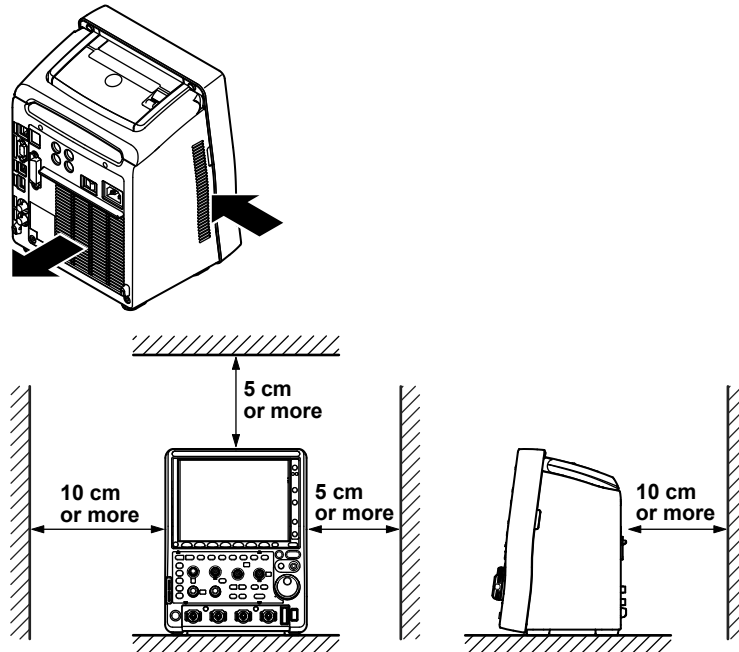

Including the spaces shown in the drawing above, allow for plenty of space to connect the cables and to open and close the cover of the built-in printer.

Ambient Temperature and Humidity

Ambient temperature	5 - 40°C
Ambient humidity	20 to 80%RH when the printer is not used. (No condensation) 35 to 80%RH when using the printer. (No condensation)

Note

- To ensure high measurement accuracy, operate the instrument in the 23 ±5°C temperature range and 55 ±10%RH.
- Condensation may occur if the instrument is moved to another place where the ambient temperature is higher, or if the temperature changes rapidly. In such cases, allow the instrument adjust to the new environment for at least an hour before using the instrument.

Do not install the instrument in the following places.

- In direct sunlight or near heat sources.
- Where an excessive amount of soot, steam, dust, or corrosive gas is present.
- Near strong magnetic field sources.
- Near high voltage equipment or power lines.
- Where the level of mechanical vibration is high.
- On an unstable surface.
- Outdoors or in locations subject to rain or water

Installation position

Place the instrument in a horizontal position (see the figure below).

Rubber stoppers can be attached to the four feet on the bottom of the DLM2000. Four rubber stoppers are included with the DLM2000.

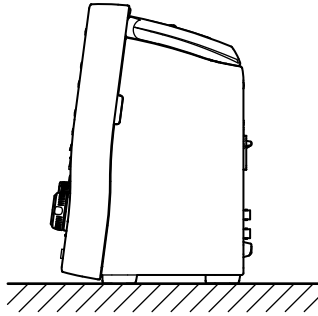

WARNING

Do not place the instrument in any position other than those shown in the above figures. Also, do not stack the instrument.

French

AVERTISSEMENT

Ne pas placer l'instrument dans des positions autres celles indiquées ci-dessus. Ne pas empiler l'instrument.

2.3 Connecting the Power

Before Connecting the Power Supply

Make sure that you observe the following points before connecting the power supply. Failure to do so may cause electric shock or damage to the instrument.



WARNING

- Before connecting the power cord, ensure that the source voltage matches the rated supply voltage of the DLM2000 and that it is within the maximum rated voltage of the provided power cord.
- Connect the power cord after checking that the main power switch of the instrument is turned off.
- To prevent electric shock or fire, be sure to use the power cord for the instrument that is supplied by YOKOGAWA.
- Make sure to connect protective earth grounding to prevent electric shock. Connect the power cord to a three-prong power outlet with a protective earth terminal.
- Do not use an ungrounded extension cord. If you do, the instrument will not be grounded.
- If an AC outlet that conforms to the supplied power cord is unavailable and you cannot ground the instrument, do not use the instrument.

French



AVERTISSEMENT

- Avant de brancher le cordon d'alimentation, vérifier que la tension source correspond à la tension d'alimentation nominale du DLM2000 et qu'elle est compatible avec la tension nominale maximale du cordon d'alimentation.
 - Brancher le cordon d'alimentation après avoir vérifié que l'interrupteur d'alimentation principal de l'instrument est sur OFF.
 - Pour éviter tout risque de choc électrique ou d'incendie, utiliser exclusivement le cordon d'alimentation fourni par YOKOGAWA et prévu pour l'instrument.
 - Relier l'instrument à la terre pour éviter tout risque de choc électrique. Brancher le cordon d'alimentation sur une prise de courant à trois plots reliée à la terre.
 - Toujours utiliser une rallonge avec broche de mise à la terre, à défaut de quoi l'instrument ne serait pas relié à la terre.
 - En l'absence de prise secteur conforme au cordon d'alimentation et dans l'impossibilité de mettre l'instrument à la terre, ne pas utiliser l'instrument.
-

Connecting the Power Cord

1. Check that both the main power switch of the DLM2000 is off.
2. Connect the power cord plug to the power connector on the rear panel.
3. Connect the other end of the cord to an outlet that meets the conditions below. Use the three-prong power outlet equipped with a protective earth terminal.

Rated supply voltage*	100 to 240 VAC
Permitted supply voltage range	90 to 264 VAC
Rated supply voltage frequency	50/60 Hz
Permitted supply voltage frequency range	48 to 63 Hz
Maximum power consumption	Max. approx. 170 VA

* The DLM2000 can use a 100-V or a 200-V system for the power supply. The maximum rated voltage differs according to the type of power cord. Check that the voltage supplied to the DLM2000 is less than or equal to the maximum rated voltage of the provided power cord (see page iii) before using it.

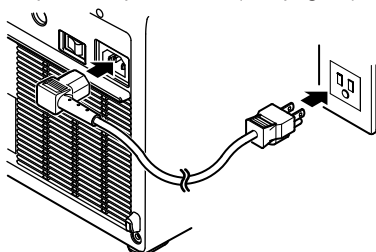

Turning the Instrument On

Before Turning On the Power, Check That:

- The instrument is installed properly: "2.2 Installing the Instrument"
- The power cord is connected properly: Previous page

Turning On the Main Power Switch

1. Flip the power switch on the rear panel to the ON (|) position.
The front-panel power switch illuminates in red-orange.

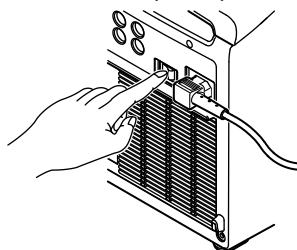

Turning On the Power Switch

2. Press the power switch on the front panel.
The power switch color will change from red-orange to green.

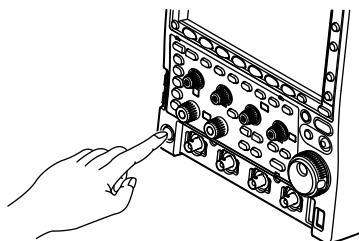

Note

If you turn off the main power switch with the front-panel power switch turned on (with the power switch illuminated in green), you can start the DLM2000 the next time by simply turning on the main power switch. However, if you turn off the main power switch while the front-panel power switch is turned on, the setup data immediately before the power switch is turned off will not be stored properly.

2.3 Connecting the Power

Operations Performed When the Power Is Turned On

When the power switch is turned On, a self-test and calibration start automatically. When the DLM2000 starts normally, the waveform display screen appears. Check that the DLM2000 has started normally before you use it.

If the DLM2000 Does Not Start Normally When the Power Is Turned On

Turn off the power switch, and check the following items.

- Check that the power cord is securely connected.
- Check that the correct voltage is coming to the power outlet. → Page 2-5
- Initialize the settings to their factory defaults by turning on the power switch while holding down the RESET key.

If the instrument still does not work properly, contact your nearest YOKOGAWA dealer for repairs.

Note

- After turning the power switch OFF, wait at least 10 seconds before you turn it on again.
 - It takes several seconds for the startup screen to appear.
-

Turning the Instrument Off

CAUTION

Abruptly turning off the main power switch or unplugging the power cord while data is being saved or the internal printer is printing may corrupt the media on which data is being saved or damage the built-in printer. Also, the data being saved is not guaranteed. Always turn the main power switch off after data has been saved.

French

ATTENTION

Mettre brutalement l'instrument hors tension ou débrancher le cordon d'alimentation pendant l'enregistrement de données ou le fonctionnement de l'imprimante interne peut corrompre le support d'enregistrement des données ou endommager l'imprimante intégrée. Les données en cours d'enregistrement pourront également être perdues. Toujours mettre l'instrument hors tension après que les données ont été enregistrées.

Turning Off the Power Switch

1. Press the power switch on the front panel.

Turning Off the Main Power Switch

2. Check that the front-panel power switch changes from green to red-orange, and then flip the power switch on the right side panel to the OFF (○) position.

Operations Performed When the Power Is Turned Off

The settings immediately before the power switch is turned off are stored. Therefore, the next time the power is turned on, waveforms are measured using those settings.

Note

If you turn off the main power switch on the rear panel while the power switch on the front panel is turned on, the setup data immediately before the power switch is turned off will not be stored properly. The next time you turn on the main power switch, the front-panel power switch automatically turns on, and the instrument starts using the previous settings that were stored properly. When this occurs, a message appears on the screen, but it does not mean that the instrument is broken. When turning the power off, turn off the power switch on the front panel, and then turn off the main power switch on the rear panel.

To Make Accurate Measurements

- Allow the instrument to warm up for at least 30 minutes after turning on the power switch.
- After the instrument has warmed up, perform calibration.
- If auto calibration is set to ON, the DLM2000 will automatically perform calibration when you perform one of the operations below if the following times have passed since the power was turned on.
 - 3 minutes, 10 minutes, 30 minutes, 1 hour, and each following hour
- When you change time/div during waveform acquisition (when the RUN/STOP key is illuminated)
- When you start waveform acquisition after stopping waveform acquisition (so that the RUN/STOP key is not illuminated)

If calibration is executed while signals are being applied to the DLM2000, we recommend that you stop signal application and recalibrate the DLM2000.

2.4 Connecting the Probe



WARNING

- Always turn off the power of the device under measurement before connecting the device under measurement to the instrument. It is extremely dangerous to connect or disconnect a measuring lead while the device under measurement is on.
- Do not apply an input voltage that exceeds the maximum input voltage, withstand voltage, or allowable surge voltage.
- To avoid electric shock, be sure to ground the instrument, and connect the ground of the probe and input connector to the ground of the item being measured.
- Avoid continuous connections in environments in which a voltage surge may occur.
- If over-range is indicated, the DLM2000 may be receiving a voltage higher than the observed waveform or measured waveform values.* To prevent electric shock, change the vertical scale with the SCALE knob so that the entire amplitude of the waveform is displayed within the waveform display area, and check the input voltage level.
 - * If the input coupling is set to AC, the over-range indicator may not be displayed. For details, see section 1.1, "Setting the Input Coupling," in the user's manual, IM 710105-02E.



CAUTION

- The probe interface terminals are located near the input terminals on this instrument. Do not short the probe interface terminals. When you connect a probe, make sure to prevent an excessive voltage caused by static electricity, etc., from being applied to the probe interface terminal, as this may damage the terminal.
- The maximum input voltage for 1 M Ω input is 150 Vrms when the frequency is less than or equal to 1 kHz. Applying a greater voltage may damage the input section. For frequencies above 1 kHz, damage may occur even if the voltage is less than 150 Vrms.
- The maximum input voltage for 50 Ω input is 5 Vrms or 10 Vpeak. Applying a voltage greater than either of these limits may damage the input section.
- For information about how to handle a probe, refer to the user's manual that came with the probe.

French

**AVERTISSEMENT**

- Toujours mettre l'appareil à mesurer hors tension avant de le brancher sur l'instrument. Il est extrêmement dangereux de brancher un câble de mesure lorsque l'appareil à mesurer est sous tension.
- Ne pas dépasser les valeurs maximales de tension d'entrée, de tension de maintien ou de surtension admissible.
- Pour éviter tout risque de choc électrique, relier l'instrument à la terre et brancher la terre de la sonde et du connecteur d'entrée sur la terre de l'appareil à mesurer.
- Éviter les connexions continues dans les environnements pouvant être soumis à surtension.
- En cas de dépassement, le DLM2000 risque de recevoir une tension supérieure à la forme d'onde observée ou aux valeurs de forme d'onde mesurées.* Pour éviter tout risque de choc électrique, modifier l'échelle de gain vertical à l'aide du bouton SCALE, de sorte que l'amplitude entière de la forme d'onde s'affiche sur l'afficheur, et vérifier le niveau de tension d'entrée.
 - * Si le couplage d'entrée est réglé sur courant alternatif (CA), l'indicateur de dépassement de plage risque de ne pas s'afficher. Pour en savoir plus, voir la section 1.1 « Setting the Input Coupling » dans le manuel d'utilisation IM 710105-02E.

**ATTENTION**

- Sur cet instrument, les bornes d'interface de sonde se situent à proximité des bornes d'entrée. Ne pas court-circuiter les bornes d'interface de sonde. Lors du branchement d'une sonde, éviter qu'une tension excessive, causée entre autre par l'électricité statique, ne soit appliquée sur la borne d'interface de sonde, car cela pourrait l'endommager.
- La tension d'entrée maximale pour une entrée de 1 M Ω est de 150 Vrms lorsque la fréquence est inférieure ou égale à 1 kHz. L'application d'une tension supérieure pourrait endommager la section d'entrée. Si la fréquence est supérieure à 1 kHz, une tension inférieure à 150 Vrms pourra tout de même endommager la section d'entrée.
- La tension d'entrée maximale pour une entrée de 50 Ω est de 5 Vrms ou 10 Vcrête. L'application d'une tension supérieure à l'une de ces limites pourrait endommager la section d'entrée.
- Pour toute information sur la manipulation de la sonde, se reporter au manuel d'utilisation fourni avec la sonde.

Connecting the Probe

Connect a probe (or measurement input cable such as a BNC cable) to the input terminal on the bottom of the front panel. The input impedance is $1\text{ M}\Omega \pm 1.0\%$ and approximately 20 pF or $50\ \Omega \pm 1.0\%$.

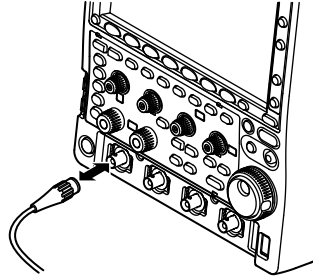

Precautions to Be Taken When Connecting Cables

- When connecting a probe to the instrument for the first time, perform phase correction of the probe as described in section 2.5, "Compensating the Probe (Phase Correction)." If you do not, frequency characteristics will not be flat, and measurements will not be correct. Perform the phase correction on each channel to which a probe is to be connected.
- Note that if the object being measured is directly connected to the instrument without using a probe, correct measurements may not be possible because of the effect of input impedance on the instrument. Use caution.

About Probes

Specification of standard supplied probe (model 701938 or 701939), after probe phase compensation

For details, see the manual that came with the probe.

Item	Specification
Overall probe length	701938: 1.5 m 701939: 1.3 m
Input impedance	$10\text{ M}\Omega \pm 2\%$
Input capacitance	701938: Approx. 13 pF 701939: Approx. 10.5 pF
Attenuation ratio	10 : 1 $\pm 2\%$
Bandwidth	701938: DC to 200 MHz (not exceeding -3 dB) 701939: DC to 500 MHz (not exceeding -3 dB)
Rise time	701938: 1.75 ns or less (typical*) 701939: 700 ps or less (typical*)
Maximum input voltage	600 V (DC+ACpeak) or 424 Vrms

* Typical values are typical or mean values. They are not strictly guaranteed.

Specification of miniature passive probe (701946), after probe phase compensation

On models with the /EX52, /EX54, /EX22, or /EX24 option, 701946 passive probes are provided in place of standard supplied probes.

For details, see the manual that came with the probe.

Item	Specification
Overall probe length	1.3 m
Input impedance	10 M Ω \pm 1%
Input capacitance	Approx 9.5 pF
Attenuation ratio	10 : 1 \pm 2%
Bandwidth	DC to 500 MHz (not exceeding -3 dB)
Rise time	700 ps or less (typical*)
Maximum input voltage	400 V _{rms}

* Typical values are typical or mean values. They are not strictly guaranteed.

Precautions to Be Taken When Using Voltage Probes Other Than Those Provided with the Instrument

- When measuring a signal including a frequency close to 500 MHz, use a probe with a frequency range above 500 MHz.
- Measurement will only be correct if the attenuation ratio is set properly. Check the attenuation ratio of the probe that you are using and set it properly.

Setting the Probe Attenuation Ratio or Voltage-Current Conversion Factor

When using a probe not supported by the probe interface connector, set the DLM2000 attenuation ratio or voltage-current conversion factor to match the probe attenuation ratio or voltage-current conversion factor. If this setting is not carried out, correct measurement values will not be displayed.

Connecting a Probe Supported by the Probe Interface Connector

- If you connect a probe* supported by the probe interface connector to the DLM2000, the probe type is automatically recognized, and the attenuation ratio set. Power is supplied to the probe through the probe interface, and therefore it is not necessary to connect the probe power cable to the probe power terminals.
- You can execute automatic zero adjustment on a current probe that is compatible with the probe interface connector.

* For a list of compatible probes, see "Optional Accessories" on page vi.

Connecting FET Probe, Current Probe, Differential Probe, or Deskew Correction Signal Source

If you are using the YOKOGAWA's FET Probes, Current Probes, Differential Probes, or Deskew Correction Signal Source, use the Probe Power (option) on the DLM2000 rear panel for the power supply. For details on the connection procedure, see the manual that comes with the respective product.

* For a list of probes and signal sources, see "Optional Accessories" on page vi.



CAUTION

Do not use the Probe Power Terminal (option) on the DLM2000 rear panel for purposes other than supplying power to the FET Probe, Current Probe, Differential Probe, or Deskew Correction Signal Source. Also, be sure that the total current of the four Probe Power Terminals and the four Probe Interface Terminals does not exceed 1.2 A. Otherwise, the device connected to the Probe Power Terminals or to the DLM2000 may break.

French



ATTENTION

Ne pas utiliser la borne d'alimentation de sonde (en option) sur le volet arrière du DLM2000 à d'autres fins que l'alimentation de la sonde FET, sonde de courant, sonde différentielle ou source de signal de correction Deskew. Vérifier également que le courant total des quatre bornes d'alimentation de sonde et des quatre bornes d'interface de sonde ne dépasse pas 1,2 A, car cela risquerait d'endommager le DLM2000 ou l'appareil connecté aux bornes d'alimentation de sonde.

Handling Precautions of the Probe Interface Terminals and Probe Power Terminals

If you are connecting the YOKOGAWA's FET Probes, Current Probes, Differential Probes, or Deskew Correction Signal Source to the Probe Power Terminals (option) on the rear panel, be sure that the total current of the four Probe Power Terminals and the four Probe Interface Terminals does not exceed 1.2 A. Otherwise, the DLM2000 operation may become unstable due to the activation of the excessive current protection circuit of the power supply.

- When using current probes (701932/701933), the number of probes is limited, depending on the measured current (the current measured by the current probes). The characteristics of measured current versus current consumption for active probes that can be connected to the DLM2000 are as follows.

701928

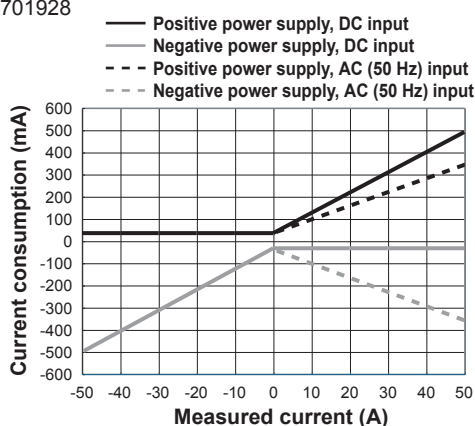

701929

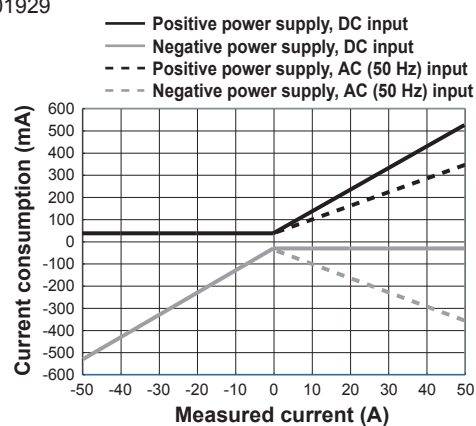

701931

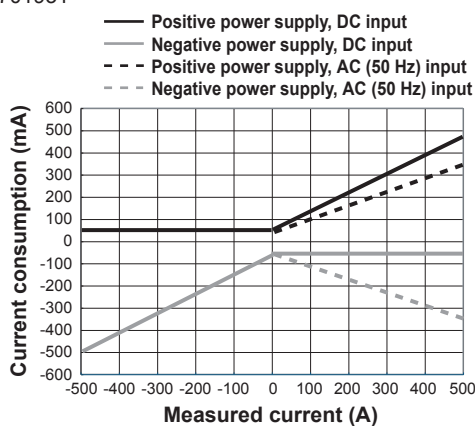

701932/701933

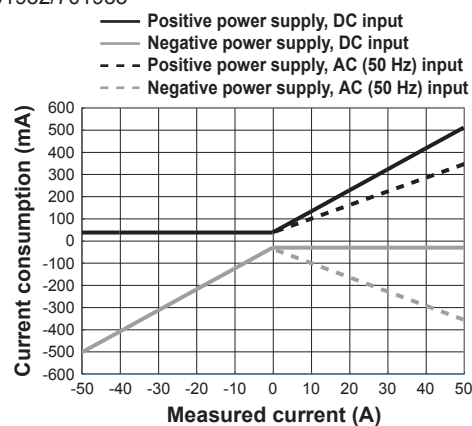

- In calculations, take the maximum current consumption of an FET probe (700939) or differential probe (700924, 700925, 701920, 701921, 701922, or 701926) to be 125 mA for both negative and positive voltages. Take the maximum current consumption of a differential probe (701927) to be 50 mA for both negative and positive voltages.

2.5 Compensating the Probe (Phase Correction)

Be sure to perform phase correction of the probe first when using a probe to make measurements.



CAUTION

Do not apply external voltage to the signal output terminal for probe compensation adjustment. Doing so may damage the internal circuitry.

French



ATTENTION

Ne pas appliquer de tension externe sur la borne de sortie de signal afin d'ajuster la compensation de sonde. Cela pourrait endommager le circuit interne.

Procedure

1. Turn ON the power switch.
2. Connect the probe to the input terminal to which the signal is to be applied.
3. Connect the tip of the probe to the signal output terminal for probe compensation adjustment on the front panel of the instrument and to the ground wire to the functional ground terminal.
4. Perform auto setup according to the procedures given in section 3.5, "Performing Auto Setup."
5. Insert a flat-head screwdriver to the phase adjustment hole and turn the variable capacitor to make the displayed waveform a correct rectangular wave.

Signal output terminal for probe compensation adjustment

Functional ground terminal

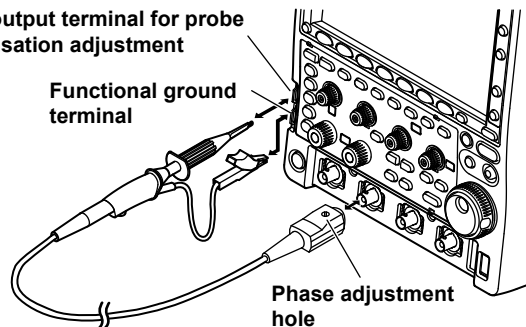

Phase adjustment hole

Explanation**Necessity of Phase Correction of the Probe**

The probe comes with its phase corrected approximately to match the input capacitance of the relevant oscilloscope. However, there is variance in the input resistance and input capacitance of each input channel of individual oscilloscopes. This results in a mismatch in the voltage divider ratio between low and high frequency signals and causes uneven frequency characteristics.

There is a variable capacitor for adjusting the division ratio (trimmer) for high frequency signals on the probe. The phase is corrected by adjusting this trimmer so that even frequency characteristics are obtained.

When using the probe for the first time, make sure to perform phase correction.

Because the input capacitance varies on each channel, probe compensation is required when the probe is switched from one channel to another.

Phase Compensation Signal

The following square wave signal is output from the signal output terminal for probe compensation adjustment.

Frequency: Approx. 1 kHz

Amplitude: Approx. 1 V

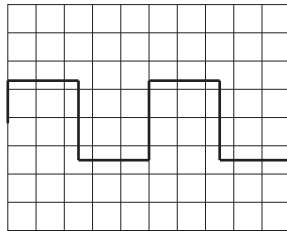
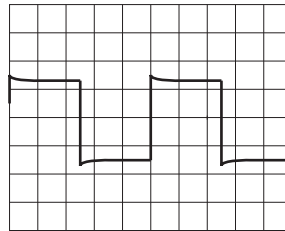
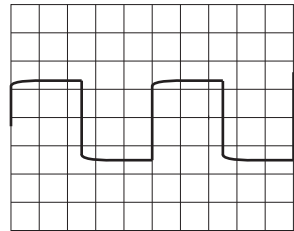
Differences in the Waveform due to the Phase Correction of the Probe**Correct waveform****Over compensated (The gain in the high-frequency region is too high.)****Under compensated (The gain in the high-frequency region is too low.)**

2.6 Connecting Logic Probes



WARNING

- Always turn off the power of the device under measurement before connecting the device under measurement to the instrument.
 - Do not apply an input voltage that exceeds the maximum input voltage.
 - To avoid electric shock, be sure to ground the instrument, and connect the ground of the probe and input connector to the ground of the item being measured.
-



CAUTION

- The maximum input voltage for the logic probe (701980, 701981, and 701989) input is ± 40 V (DC+ACpeak) or 28 Vrms. And The maximum input voltage for the logic probe (701988) input is ± 42 V (DC+ACpeak) or 29 Vrms. Applying a voltage greater than either of these limits may damage the logic probe or the instrument. If the frequency is high, damage may occur even if the voltage is below the values specified above. For information about derating based on frequency, see the user's manual of the logic probe that you are using.
 - The eight input lines on the logic port have a common ground. In addition, the ground for the instrument and the ground for the logic port is also a common ground. Do not apply inputs that have different common voltages, as doing so may cause damage to the instrument, the logic probe, or other connected instruments.
 - Make sure to turn OFF the power to the DLM2000 before connecting or disconnecting a logic probe cable (701980 or 701981).
 - For information about how to handle a logic probe, refer to the user's manual that came with the logic probe.
-

French

**AVERTISSEMENT**

- Toujours mettre l'appareil à mesurer hors tension avant de le brancher sur l'instrument.
- Ne pas dépasser les valeurs maximales de tension d'entrée.
- Pour éviter tout risque de choc électrique, relier l'instrument à la terre et brancher la terre de la sonde et du connecteur d'entrée sur la terre de l'appareil à mesurer.

**ATTENTION**

- La tension d'entrée maximale pour la sonde logique 701980, 701981, et 701989 est ± 40 V (c.c. + c.a.crête) ou 28 Vrms, et la tension d'entrée maximale pour la sonde logique 701988 est ± 42 V (c.c. + c.a.crête) ou 29 Vrms. L'application d'une tension supérieure à l'une de ces limites pourrait endommager la sonde logique ou l'instrument. Si la fréquence est élevée, une tension inférieure aux valeurs indiquées ci-dessus pourra tout de même causer des dégâts. Pour toute information sur le déclassement basé sur la fréquence, se reporter au manuel d'utilisation de la sonde logique utilisée.
- Les huit lignes d'entrée du port logique partagent la même terre. De plus, la terre de l'instrument et la terre du port logique sont également partagées. Ne pas appliquer des entrées qui ont des tensions communes différentes car cela pourrait endommager l'instrument, la sonde logique ou tout autre appareil connecté.
- Veiller à mettre le DLM2000 hors tension avant de brancher ou de débrancher un câble de sonde logique (701980 ou 701981).
- Pour toute information sur la manipulation de la sonde logique, se reporter au manuel d'utilisation fourni avec la sonde logique.

2.6 Connecting Logic Probes

Logic Signal Input Ports

Connect the logic probe (701980/701981/701988/701989) to the logic signal input port.

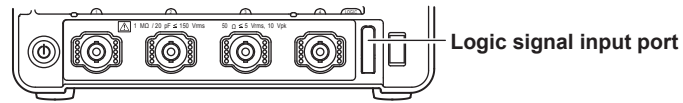

About the Logic Probe

The logic probe (701980/701981/701988/701989) is designed exclusively for the logic signal input ports of the DLM2000. Use the connection lead (accessory) to connect to the point of measurement. Do not alter the connection lead, as it may cause the lead from satisfying the specifications.

Each port has 8 lines of logic input terminals. You can set the threshold level from the DLM2000 menu.

Recommended probes: 701988/701989 (can be connected even when the DLM2000 is turned on)

Compatible probes: 701980/701981 (can be connected when the DLM2000 is turned off)

Logic Input Specifications When Used on the DLM2000

Item	When using the 701989	When using the 701988
Maximum toggle frequency ¹	250 MHz	100 MHz
Number of inputs	8	
Maximum input voltage ²	±40 V (DC + ACpeak) or 28 Vrms	±42 V (DC + ACpeak) or 29 Vrms
Input range	±6 V	±40 V
Maximum sample rate	1.25 GS/s (interleave mode OFF)	
Threshold level	±6 V (resolution: 0.05 V)	±40 V (resolution: 0.05 V)
Threshold accuracy ¹	± (100 mV + 3% of setting)	
Minimum input voltage ¹	300 mVp-p	500 mVp-p
Input impedance	Approx. 100 kΩ, approx. 3 pF (Typical) ³	Approx. 1 MΩ, approx. 10 pF (Typical) ³
Preset threshold levels	CMOS (5 V) = 2.5 V, CMOS (3.3 V) = 1.65 V, CMOS (2.5 V) = 1.25 V, CMOS (1.8 V) = 0.9 V, and ECL = -1.3 V	

1 Under standard operating conditions (see section 5.11) after warm-up.

2 For frequencies up to 1 kHz.

3 Typical values are typical or mean values. They are not strictly guaranteed.

2.7 Attaching the Panel Sheet

Attach the supplied front panel sheet to the instrument as necessary. The front panel sheet that comes with the instrument is determined by the instrument's language code. You can attach the panel sheet over the panel sheet that is affixed to the instrument when it is shipped from the factory.

Procedure

The front panel has six panel sheet hooks: two upper, two lower, one below the POSITION knob (HORIZONTAL), and one under the ZOOM knob.

Hook the panel sheet onto the two upper hooks.

Then, bend the panel sheet slightly, and hook it to the two lower hooks.

Hold near the POSITION knob (HORIZONTAL) and ZOOM knob, and insert the panel sheet into the hooks below the knobs.

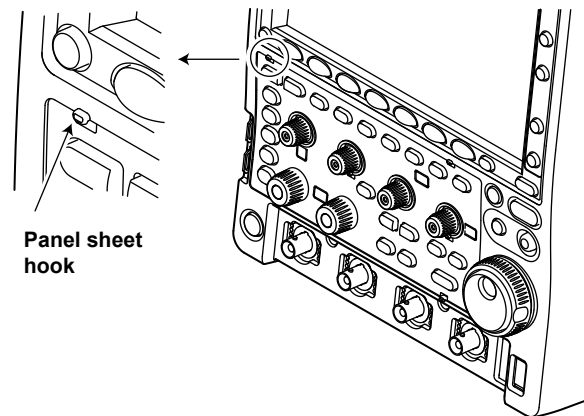

2.8 Loading Roll Paper into the Built-In Printer (Option)

This section explains how to load roll paper into the optional built-in printer.

Roll Paper for Printers

Only use roll paper specifically made for use with the DLM2000 series. The DLM2000 comes with one set of roll paper included. Use this when you first load roll paper into the built-in printer. When you require a new supply of roll paper, please contact your nearest YOKOGAWA dealer.

Part Number:	B9988AE
Specifications:	Heat sensitive paper, 10 m
Minimum Quantity:	10 rolls

Handling Roll Paper

The roll paper is made of heat sensitive paper that changes color thermochemically. Please read the following points carefully.

Storage Precautions

The heat-sensitive paper changes color gradually at temperatures of approximately 70°C or higher. The paper can be affected by heat, humidity, or chemicals, whether something has been recorded on it or not. As such, please follow the guidelines listed below.

- Store the paper in a cool, dry, and dark place.
- Use the paper as quickly as possible after you break its protective seal.
- If you attach a plastic film that contains plasticizing material such as vinyl chloride film or cellophane tape to the paper for a long time, the recorded sections will fade due to the effect of the plasticizing material. Use a holder made of polypropylene to store the roll paper.
- When starching the record paper, do not use starches containing organic solvents such as alcohol or ether. Doing so will change the paper's color.
- We recommend that you make copies of the recordings if you intend to store them for a long period of time. Because of the nature of heat-sensitive paper, the recorded sections may fade.

Handling Precautions

- Only use genuine, YOKOGAWA-supplied roll paper.
- If you touch the roll paper with sweaty hands, there is a chance that you will leave fingerprints on the paper or smudge the recorded sections.
- If you rub the surface of the roll paper against something hard, there is a chance that the paper will change color due to frictional heat.
- If the roll paper comes into contact with products such as chemicals or oil, there is a chance that the paper will change color or that the recorded sections will disappear.

Attaching the Roll Paper

**CAUTION**

- Do not touch the print head. If you do, you may burn yourself.
- Do not touch the roll paper cutter section at the end of the printer cover. Doing so may cause injury.

French

**ATTENTION**

- Ne pas toucher la tête d'impression. Vous pourriez vous brûler.
- Ne pas toucher la section du coupe-papier à l'extrémité du cache de l'imprimante. Vous pourriez vous blesser.

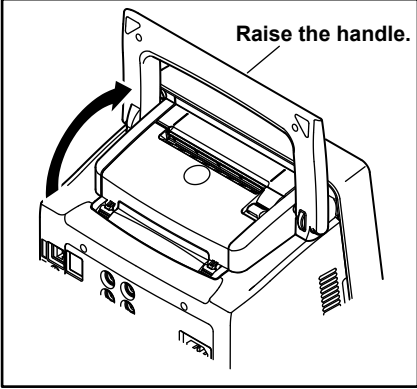
- 

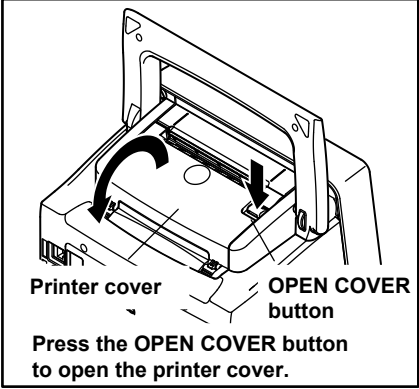
Raise the handle.
- 

Printer cover OPEN COVER button

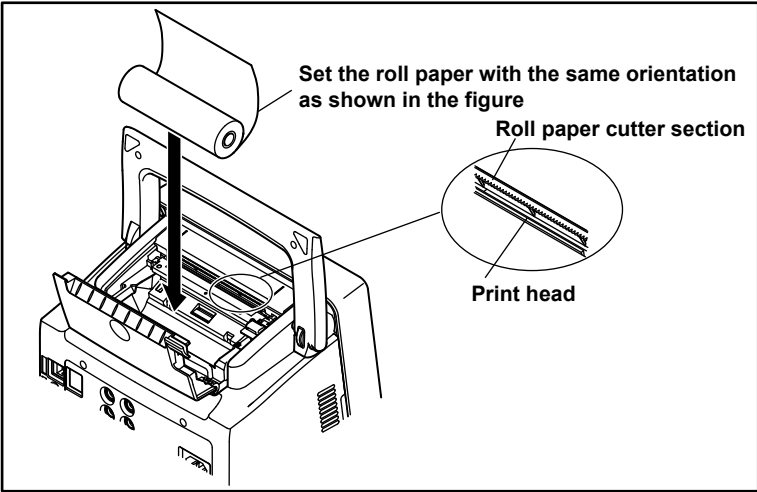
Press the OPEN COVER button to open the printer cover.
- 

Set the roll paper with the same orientation as shown in the figure

Roll paper cutter section

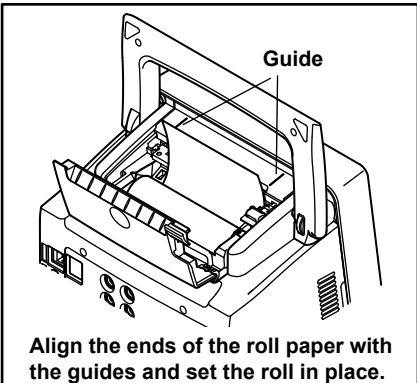
Print head
- 

Guide

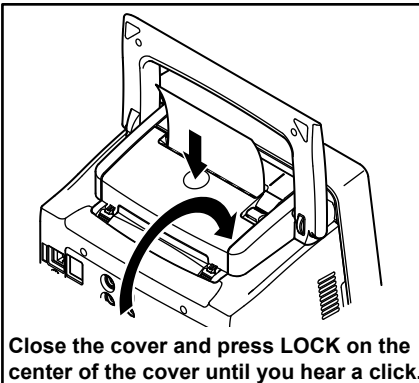
Align the ends of the roll paper with the guides and set the roll in place.
- 

Close the cover and press LOCK on the center of the cover until you hear a click.

3.1 Key and Jog Shuttle Operations

Key Operations

How to Use Setup Menus That Appear When Keys Are Pressed

The operation after you press a key varies depending on the key that you press.

DISPLAY menu

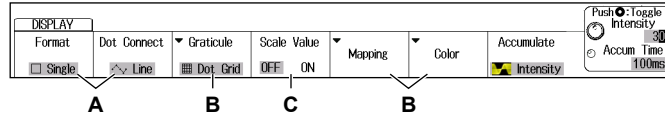

CURSORS menu

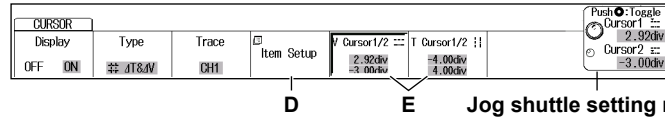

Jog shuttle setting menu

MODE menu

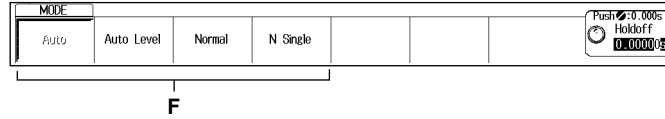

MATH/REF menu

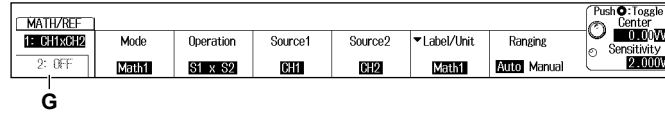

- A:** A selection menu appears when you press the soft key.
Press the soft key that corresponds to the appropriate setting.
- B:** A related setup menu appears when you press the soft key.
- C:** The selected setting switches each time you press the soft key.
- D:** Displays a dialog box or a keyboard.
Use the jog shuttle and the SET (⊙) key to set values.
- E:** Pressing the soft key selects the item that you can control using the jog shuttle.
The jog shuttle setup menu, which appears at the right end of the setup menu, shows the selected item. Use the SET key to move between digits and set the number.
- F:** Pressing a key sets the item to the setting that corresponds to that key.
- G:** Selects which item to configure when configuring a feature that consists of two items that operate with different settings, such as the MATH1 and MATH2 computation features.

How to Display the Setup Menus That Are Written in Purple below the Keys

In the explanations in this manual, "SHIFT+key name (written in purple)" is used to indicate the following operation.

1. Press the **SHIFT** key. The SHIFT key illuminates to indicate that the keys are shifted.
Now you can select the setup menus written in purple below the keys.
2. Press the key that you want to display the setup menu of.

ESC key operation

- If you press ESC when a setup menu or available options are displayed, the screen returns to the menu level above the current one.
- If you press ESC when the highest level menu is shown, the display changes as follows.

Operation of pressing ESC	When measured values are displayed	When measured values are not displayed
1st time	The setup menu disappears.	
2nd time	Measured values move outside the waveform area.	The jog shuttle setting menu disappears.
3rd time	The jog shuttle setting menu disappears.	Nothing changes from this point.
	From this point, the display position of measured values switches between outside the waveform area and inside the area each time you press ESC.	

3.1 Key and Jog Shuttle Operations

Entering Values Using the RESET (⊘) and SET (●) Keys

When you use the jog shuttle to set a value, the jog shuttle setup menu shows a RESET key mark or a SET key mark.

- **RESET Key Mark**

If the RESET key mark is displayed, you can press the RESET key to reset the value to its default value. (The value may not return to its default value depending on the DLM2000 condition.) The default value is displayed next to the RESET key mark.

- **SET Key Mark**

If there are two values that you need to set, the SET key mark appears. Press the SET key to select which value you want to set using the jog shuttle. The jog shuttle mark in front of the selected value is enlarged.

Like when the RESET key mark is displayed, you can press the RESET key to reset the value to its default value.

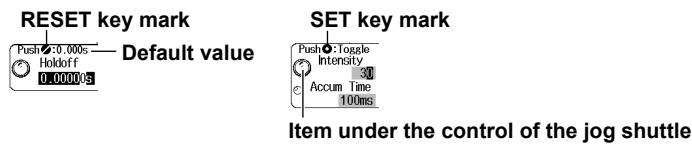

How to Enter Values in Setup Dialog Boxes

1. Use the keys to display the appropriate setup dialog box.
2. Use the **jog shuttle** or the **SET key** (●) to move the cursor to the appropriate item.
3. Press the **SET key** (●). The operation varies depending on the selected item.
 - A setup menu appears.
 - A check box is selected or cleared.
 - The item at the cursor is selected.

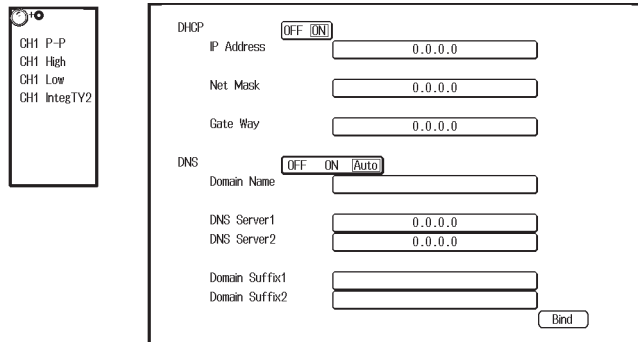

How to Clear Setup Dialog Boxes

Press the **ESC** key to clear the active setup dialog box.

Scroll Operation

If a vertical or horizontal scroll bar is shown on the screen, you can move the SET key up and down or left and right to scroll.

3.2 Entering Values and Strings

Entering Values

Using Dedicated Knobs

You can use the following dedicated knobs to enter values directly.

- POSITION knobs (VERTICAL and HORIZONTAL)
- SCALE knob (VERTICAL)
- TIME/DIV knob
- LEVEL knob (TRIGGER)
- ZOOM magnification knob

Using the Jog Shuttle

Select the appropriate item using soft keys, and change the value using the jog shuttle and the SET key. This manual sometimes describes this operation simply as “using the jog shuttle.”

Note

Items that can be set using the jog shuttle are reset to their default values when you press the RESET key.

Entering Character Strings

Use the keyboard that appears on the screen to enter file names and comments. Use the jog shuttle and the SET key to control the keyboard and enter characters.

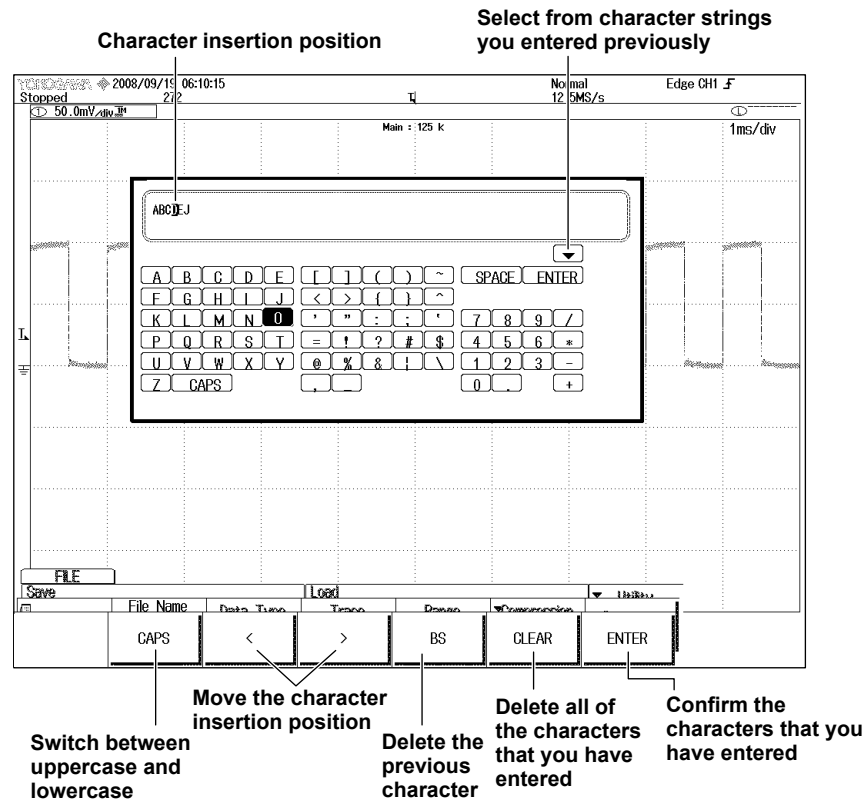

How to Operate the Keyboard

1. After bringing up the keyboard, use the **jog shuttle** to move the cursor to the character that you want to enter. You can also move the **SET** key up, down, left, and right to move the cursor.
2. Press the **SET** key to enter the selected character.
 - If a character string is already entered, use the arrow soft keys to move the cursor to the position you want to insert characters into.
 - Use the **CAPS** soft key to switch between uppercase and lowercase.
 - Use the **BS** soft key to delete the previous character.
 - Use the **CLEAR** soft key to clear all the entered characters.
3. Repeat steps 1 and 2 to enter all of the characters in the string.

Select on the keyboard to display a list of character strings that you have entered previously.

Use the **jog shuttle** to select a character string and press the **SET** key to enter the selected character string.
4. Move the cursor to ENTER on the keyboard and press the **SET** key straight down or press the **ENTER** soft key to confirm the character string and clear the keyboard.

Note

- @ cannot be entered consecutively.
- File names are not case-sensitive. Comments are case-sensitive. The following file names cannot be used due to MS-DOS limitations:
AUX, CON, PRN, NUL, CLOCK, COM1 to COM9, and LPT1 to LPT9

3.3 Using USB Keyboards and Mouse Devices

Connecting a USB Keyboard

You can connect a USB keyboard and use it to enter file names, comments, and other items.

Usable Keyboards

The following keyboards conforming to USB Human Interface Devices (HID) Class Ver. 1.1 can be used.

- When the USB keyboard language is English: 104 keyboards
- When the USB keyboard language is Japanese: 109 keyboards

Note

- Do not connect incompatible keyboards.
- The operation of keyboards that have USB hubs or mouse connectors are not guaranteed.
- For USB keyboards that have been tested for compatibility, contact your nearest YOKOGAWA dealer.

USB Port for Peripherals

Connect a USB keyboard to the USB connector for peripherals on the front or rear panel.

Connection Procedure

Connect a USB keyboard directly to the DLM2000 using a USB cable. You can connect or remove the USB cable regardless of whether or not the DLM2000 power switch is turned on (hot-plug support). Connect the type A connector of the USB cable to the DLM2000, and connect the type B connector to the keyboard. When the power switch is on, the keyboard is detected and enabled approximately 6 seconds after it is connected.

Note

- Only connect a compatible USB keyboard, mouse, printer, or storage device to the USB connector for peripherals.
- Do not connect multiple keyboards. You can connect one keyboard, one mouse, and one printer to the DLM2000.
- Do not connect and disconnect multiple USB devices repetitively. Allow at least 10 seconds after you connect or remove one USB device until you connect or remove another USB device.
- Do not remove USB cables during the time from when the DLM2000 is turned on until key operation becomes available (approximately 20 seconds).

Entering File Names, Comments, and Other Items

When a keyboard is displayed on the screen, you can enter file names, comments, and other items using the USB keyboard.

Using a USB Mouse

You can connect a USB mouse and use it to perform the same operations that you can perform with the DLM2000 keys. Also, on the menu, you can perform the same kinds of operations that you can perform by pressing a menu item's soft key or pressing the SET key by pointing to a menu item and clicking on it.

USB Port for Peripherals

Connect a USB mouse to a USB connector for peripherals on the front or rear panel of the DLM2000.

Usable USB Mouse Devices

You can use mouse devices (with wheels) that are compliant with USB HID Class Version 1.1.

Note

- For USB mouse devices that have been tested for compatibility, contact your nearest YOKOGAWA dealer.
 - Some settings cannot be configured by a mouse without a wheel.
-

Connection Procedure

Connect a USB mouse to a DLM2000 USB connector for peripherals. You can connect or disconnect the USB mouse at any time regardless of whether the DLM2000 is on or off (hot-plugging is supported). When the power switch is on, the mouse is detected approximately 6 seconds after it is connected, and the mouse pointer (⌨) appears.

Note

- Only connect a compatible USB keyboard, mouse, printer, or storage device to the USB connector for peripherals.
 - Even though there are two USB connectors for peripherals, do not connect two mouse devices to the DLM2000.
-

Operating the DLM2000 Using a USB Mouse

- Operations That Correspond to the Front Panel Keys (Top menu)

Displaying the Top Menu

Right-click on the display. A menu of the DLM2000 front panel keys appears.

Selecting an Item from the Top Menu

Click on the item that you want to select. A setup menu that corresponds to the item that you selected appears at the bottom of the display. The top menu disappears.

To display an item's submenu, point to the item. To select an item on a submenu, click on it, just as you would to select an item on the top menu.

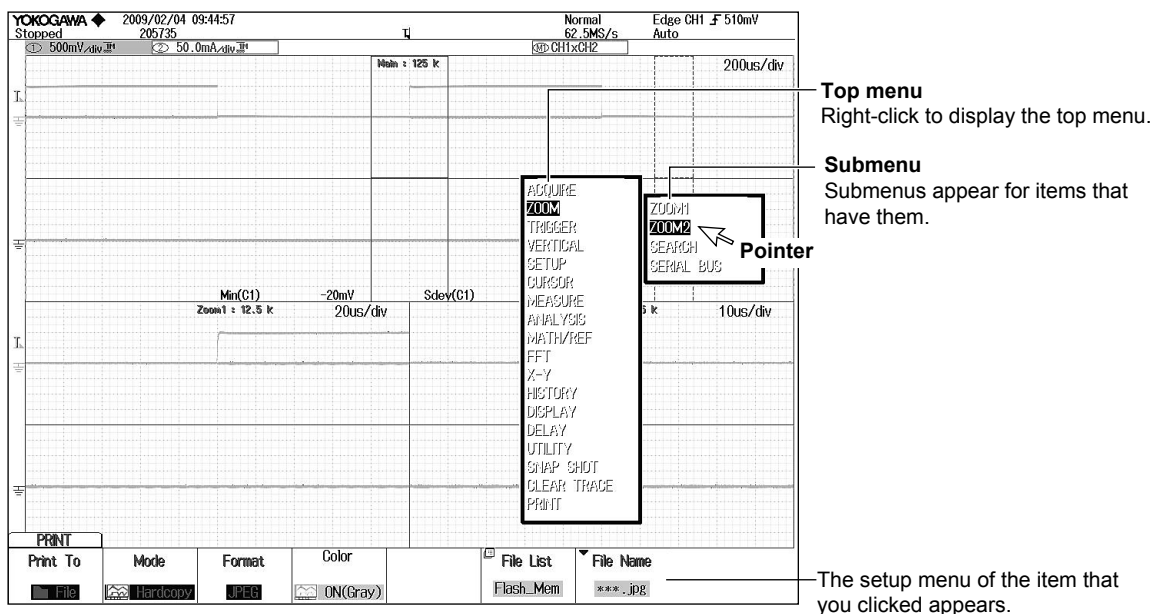

Note

- The following keys are not displayed in the top menu:
ESC, RESET, and SET

- Setup Menu Operations (Same as soft key operations)

Selecting a Setup Menu Item

Click on the setup menu item that you want to select.

If a selection menu appears after you select an item, click on the selection menu item that you want to choose.

If an item such as ON or OFF appears, click on the item to change its setting.

For menu items that are usually selected using the job shuttle and the SET key, clicking on the item that you want to select will confirm your selection and close the dialog box.

Click within this area to display a selection menu.

Clicking on the selection menu item that you want to select will confirm your selection.

Click within this area to change the selected item.

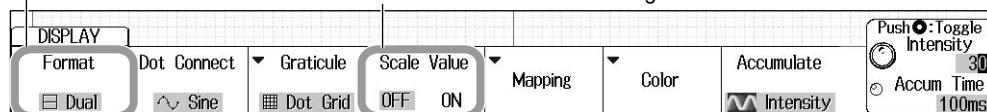







3.3 Using USB Keyboards and Mouse Devices

Clearing the Menu

To clear the menu, click outside of it.

- **Specifying Values**

The following description explains how to specify values for menu items that have a  icon next to them.

- If there are two  icons next to a single menu item, click on the item to select an item to configure.
- To increase a value, rotate the mouse wheel back.
- To decrease a value, rotate the mouse wheel forward.
- To increase a value, move the pointer above the value so that the pointer becomes a , and then click the left mouse button.
- To decrease a value, move the pointer below the value so that the pointer becomes a , and then click the left mouse button.
- To move the decimal place, point to the left or right of the value you want to set so that the pointer becomes a  or a , and then click the left mouse button. The decimal place will move one place to the right or left each time you click the left mouse button.

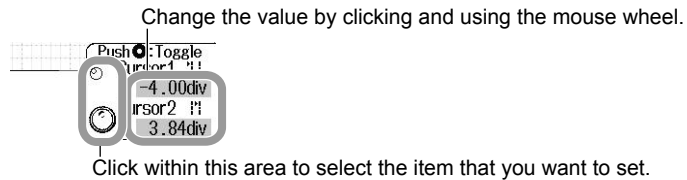

- **Selecting Check Boxes**

To select a check box, click on it. To clear a check box, click on it again. Click on the item that you want to select.

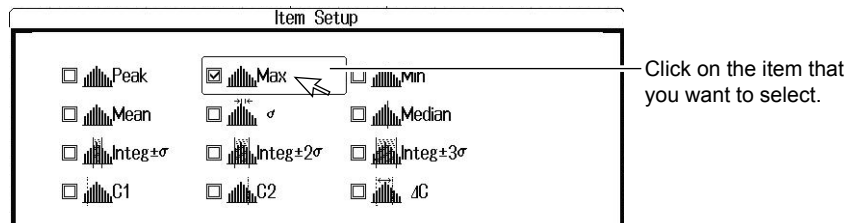

Note

To close a dialog box, click outside of it.

- **Selecting a file, directory, or media drive from the File List window.**

Click on a file, directory, or media drive to select it.

Rotate the mouse wheel to scroll through the file list.

To cancel your selection, click outside of the File List window. The File List window will close when you cancel your selection.

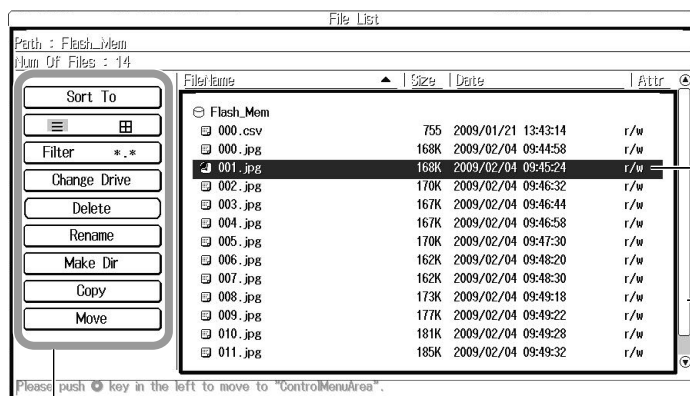

Click on the file, directory, or media drive that you want to select.

Scroll bar

Click on the item that you want to select.

- **Setting V/DIV and TIME/DIV**

Setting V/DIV

When the waveform of a channel whose voltage is being measured appears on the display, move the pointer close to the V/DIV value. The pointer becomes a .

Rotate the mouse wheel forward to increase the V/DIV value, and rotate it back to decrease the value.

Setting TIME/DIV

Move the pointer close to the TIME/DIV value. The pointer becomes a .

Rotate the mouse wheel forward to increase the TIME/DIV value, and rotate it back to decrease the value.

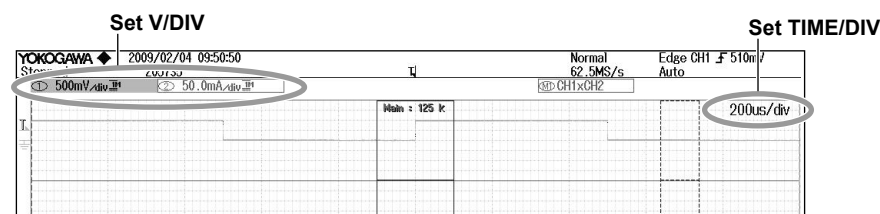

3.4 Synchronizing the Clock

This section explains how to set the DLM2000 clock, which is used to generate timestamps for measured data and files. The DLM2000 is factory shipped with a set date and time. You must set the clock before you start measurements.

Procedure

1. Press **UTILITY** key to display the Utility menu.

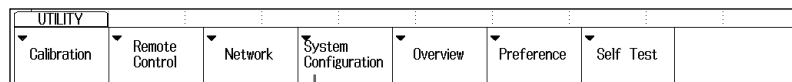

System Configuration

2. Press the **System Configuration** soft key to display the system menu.
3. Press the **Date/Time** soft key to display the Date/Time Setup dialog box.

YOKOGAWA 2011/04/12 16:29:02 Normal Edge CH1 F 51.0mV
Running 12169 62.5MS/s Auto

50.0mV/div Main: 125 k 200us/div

Date/Time Setup

Display: OFF ON

Format: 2008/09/30

Date: Year (2011) Month (4) Day (12)

Time: Hour (16) Minute (28) Second (56)

Time Diff. GMT: Hour (9) Minute (0)

Set

UTILITY

Date/Time Click Sound OFF ON Language System LCD Storage Manager USBKeyboard JPN ENG USB Function

Date/Time

Turn the date and time display on or off

Set the date and time display format

Set the year, month, day, hour, minute, and second

Set the time difference from Greenwich Mean Time

Confirm the settings

4. Use the **jog shuttle** and the **SET** key to set the date and time.

Explanation**Turning the Display On and Off (Display)**

Sets whether or not to display the date and time on the DLM2000 screen.

Display Format (Format)

You can display the date in one of the following formats.

- Year/Month (numeric)/Day
- Day/Month (numeric)/Year
- Day-Month (English abbreviation)-Year (the lower two digits)
- Day Month (English abbreviation) Year

Time Difference from Greenwich Mean Time (Time Diff. GMT)

Set the time difference between the region where you are using the DLM2000 and Greenwich Mean Time.

Selectable range: -12 hours 00 minutes to 13 hours 00 minutes

For example, Japan standard time is ahead of GMT by 9 hours. In this case, set Hour to 9 and Minute to 00.

Checking the Standard Time

Using one of the methods below, check the standard time of the region where you are using the DLM2000.

- Check the Date, Time, Language, Regional Options on your PC.
- Check the standard time at the URL on the right.<http://www.worldtimeserver.com/>

Note

- The DLM2000 does not support Daylight Savings Time. To set the time to Daylight Savings Time, reset the time difference from Greenwich Mean Time.
- Date and time settings are backed up using an internal lithium battery. They are retained even if the power is turned off.
- The DLM2000 has leap-year information.

3.5 Performing Auto Setup

Procedure

Executing Auto Setup

1. Press **AUTO** key.

Auto setup is executed, and an Undo item appears.

Undoing Auto Setup

2. Press the **Undo** soft key to revert to the settings that were in effect before executing auto setup.

Explanation

The auto setup feature automatically sets the V/div, T/div, trigger level, and other settings to the most suitable values for the input signals.

Center Position after the Execution of Auto Setup

The center position after you execute auto setup will be 0 V.

Source Channels

Auto setup is performed on all channels except LOGIC.

If LOGIC is selected (the LOGIC key is illuminated), auto setup is not performed on CH4. LOGIC waveforms appear using the same settings that were used before you executed auto setup.

Waveforms Displayed before the Execution of Auto Setup

Data in the acquisition memory is overwritten, and waveforms that were displayed before you executed auto setup are cleared.

Undoing Auto Setup

You can press the Undo soft key to revert to the settings that were in effect before you executed auto setup. You cannot undo auto setup if you switch to a different setup menu or clear the Undo menu using the ESC key.

Signals That Auto Setup Can Be Applied To

Frequency Approx. 50 Hz or higher

Absolute input voltage Signals whose maximum value is at least approximately 20 mV (at 1:1 setting)

Type Simple, repeating signals

Note

- The auto setup feature may not work properly for signals that include a DC component or high-frequency components.
 - To measure serial bus signals, execute auto setup in the appropriate serial bus signal setup menu.
-

Settings after the Execution of Auto Setup

CH1 to CH4 settings

Position	0 div
Coupling	DC
BW	FULL
Offset	0 V
Invert	OFF

Acquisition settings

Record Length	The same as the value used before you executed auto setup However, if the record length is such that the DLM2000 cannot acquire waveforms in Single mode, the record length is set to the maximum record length at which the DLM2000 can acquire waveforms repeatedly.
Mode	Normal
Hi Resolution	OFF
Interleave	OFF
Sampling Mode	Interpolation

Trigger settings

Trigger type	Edge
Mode	Auto
HoldOff	20 ns
Delay	0 s
Position	50%
Slope	Rising
Coupling	DC
HF Rejection	OFF
Noise Rejection	OFF
Window	OFF

Settings that depend on the input signal

CH On/Off	On if the DLM2000 detects a voltage of ± 20 mV (1:1) or higher and Off otherwise
V/div	Selects the range with the highest sensitivity that does not exceed ± 3.5 divisions
Trigger Level	Center
Trigger Source	The channel with the lowest frequency among the signals whose amplitude (Max – Min) is at least 1 division
Time/div	The fastest sweep range that allows at least two periods of the fastest signal among the signals whose amplitude is at least 1 division to be observed. The sweep range must be at least 5 ms/division.

The values of settings not listed here do not change.

3.6 Resetting the DLM2000 to Its Factory Default Settings

Procedure

Resetting the DLM2000 to Its Factory Default Settings

1. Press **DEFAULT** key.

The DLM2000 is reset to its factory default settings.

An Undo item appears.

Undoing the Reset Operation

2. Press the **Undo** soft key to revert to the previous settings.

Explanation

You can reset the DLM2000 settings to their factory default values. This feature is useful when you want to cancel all of the settings that you have entered or when you want to redo measurement from scratch.

Settings That Cannot Be Reset to Their Factory Default Values

- Date and time settings
- Communication settings
- Language setting (English or Japanese)
- Measured value font size setting

Undoing the Reset Operation

If you reset the settings by mistake, you can press the Undo soft key to revert to the previous settings. However, you cannot undo the reset operation if you switch to a different setup menu or clear the Undo item by pressing the ESC key.

To Reset All Settings to Their Factory Default Settings

While holding down the RESET key (⓪), turn the power switch on. All settings are reset to their factory default values except the date and time settings (the display on/off setting will be reset) and the setup data stored in internal memory.

3.7 Starting and Stopping Waveform Acquisition

Procedure

Starting or Stopping Waveform Acquisition.

Press **RUN/STOP** key to start or stop waveform acquisition.

The key is illuminated while the DLM2000 is acquiring waveforms.

Acquiring Waveforms Using a Single Trigger

Press **SINGLE** key to start waveform acquisition.

The key is illuminated while the DLM2000 is acquiring waveforms.

The DLM2000 acquires waveforms once when it is triggered and then stops waveform acquisition.

To cancel waveform acquisition, press **RUN/STOP** key.

If you set the record length to a value that allows only one waveform to be acquired, pressing **RUN/STOP** key will produce the same result as pressing **SINGLE** key.

Explanation

Waveform Acquisition and Indicators

- When **RUN/STOP** key or **SINGLE** key is illuminated, the DLM2000 is acquiring waveforms. "Running" appears at the upper left of the screen.
- When **RUN/STOP** key and **SINGLE** key are not illuminated, the waveform acquisition is stopped. "Stopped" appears at the upper left of the screen.

DLM2000 Operation When the Acquisition Mode Is Set to Averaging

- Averaging stops when you stop waveform acquisition.
- If you restart waveform acquisition again, averaging starts from the beginning.

RUN and STOP Operations during Accumulation

- Accumulation stops when you stop waveform acquisition.
- If you restart waveform acquisition, past waveforms are cleared, and accumulation starts over.

Note

- If you start waveform acquisition using **RUN/STOP**, past data stored in the acquisition memory is cleared.
- You can use the snapshot feature to retain the displayed waveform on the screen. This feature allows you to retain a waveform on the screen while the DLM2000 continues signal acquisition.

3.8 Calibrating the DLM2000

Procedure

1. Press **UTILITY** key.

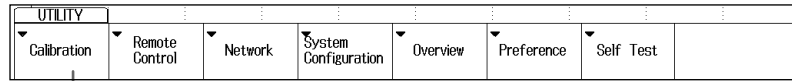

Calibration

2. Press the **Calibration** soft key.

Executing Calibration

3. Press the **Cal Exec** soft key to execute calibration.

Turning Auto Calibration On or Off

3. Press the **Auto Cal** soft key to select ON or OFF.

Explanation

Calibration

Calibrates the following items. Execute calibration when you want to make accurate measurements.

- Vertical axis ground level and gain
- Trigger threshold level
- Measured time value for repetitive sampling

Note

Calibration is performed automatically when the power switch is turned on.

Notes about Calibration

- Allow the DLM2000 to warm up for at least 30 minutes before you execute calibration. If you execute calibration immediately after power-on, the calibrated values may drift due to temperature changes or other environmental changes.
- Execute calibration in a stable temperature environment ranging from 5 to 40°C (23 ± 5°C recommended).
- Do not apply signals when calibrating. Calibration may not be executed properly when input signals are being applied to the DLM2000.

Auto Calibration (Auto Cal)

Auto calibration is executed when you perform one of the following operations and any of the time periods listed below has elapsed since the power was turned on.

3 minutes, 10 minutes, 30 minutes, 1 hour, and each following hour

- When you change time/div during waveform acquisition (when the RUN/STOP key is illuminated)
- When you start waveform acquisition after stopping waveform acquisition (so that the RUN/STOP key is not illuminated)

If calibration is executed while signals are being applied to the DLM2000, we recommend that you stop signal application and recalibrate the DLM2000.

3.9 Displaying Help

Procedure

Displaying Help

Press the **help** key (?) to display help.

The table of contents and index appear in the left frame, and text appears in the right frame.

Switching between Frames

To switch to the frame that you want to control, move the **SET** key (○) left and right.

Moving Cursors and Scrolling

To scroll through the screen or to move the cursor in the table of contents or index, turn the jog shuttle.

Moving to the Link Destination

To move to a description that relates to blue text or to move from the table of contents or index to the corresponding description, move the cursor to the appropriate blue text or item, and press the **SET** key (○).

Displaying Panel Key Descriptions

With help displayed, press a panel key to display an explanation of the panel key.

Returning to the Previous Screen

To return to the previous screen, press the **RESET** key (⊘).

Hiding Help

Press **help** key (?) to clear help.

4.1 Applying Signals to Measure

To help you understand basic oscilloscope operations, this chapter explains how to use the DLM2000 probe compensation signal and perform procedures from displaying waveforms to saving data.

Connecting to the Power Supply

Follow the procedure in section 2.3, "Connecting the Power," and turn the DLM2000 power switch on.

Connecting a Probe

Follow the procedure in section 2.4, "Connecting the Probe" to connect the 701938, 701939, or 701946 probe that is supplied with the DLM2000.

On models with the /EX52 or /EX54 option, 701946 passive probes are provided in place of 701939 passive probes.

On models with the /EX22 or /EX24 option, 701946 passive probes are provided in place of 701938 passive probes.

Correcting the Probe Phase

Follow the procedure in section 2.5, "Compensating the Probe (Phase Correction)" to correct the probe phase.

The waveform of the DLM2000 probe compensation signal appears.

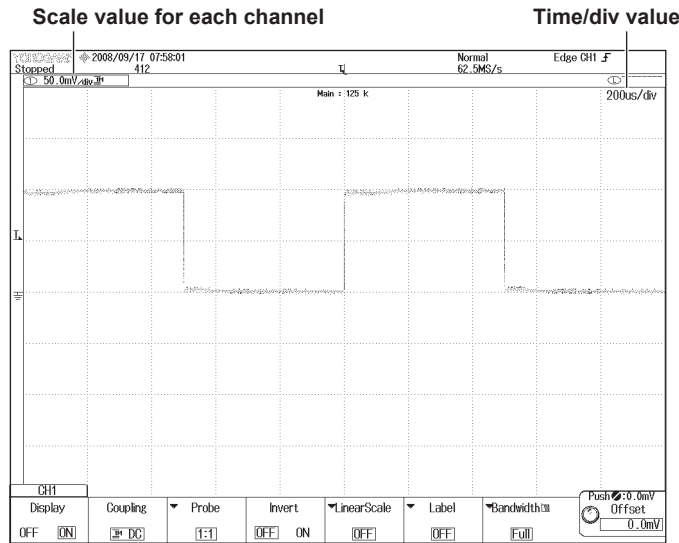

Note

Because the 701938, 701939, and 701946 passive probes have probe ID pins, the DLM2000 automatically detects the probe attenuation when you connect one of these probes to a DLM2000 probe terminal.

4.2 Changing the Waveform Display Conditions

This section explains how to change vertical control settings such as the voltage scale and vertical position as well as horizontal control settings such as the time scale. Change these settings while waveform acquisition is in progress.

Changing the Voltage Sensitivity from 500 mV/division to 200 mV/division

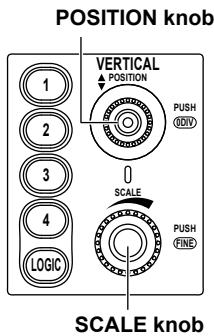

1. Press the appropriate CH key of the channel whose scale you want to change (CH1 in this example).
2. Use the **SCALE** knob to change the scale to 200 mV/div. The scale value appears enlarged in the scale display section of the screen.

Press the **SCALE** knob to set the scale in fine detail (FINE illuminates).

The new voltage sensitivity A portion of the waveform can no longer be seen, because the voltage sensitivity has been increased.

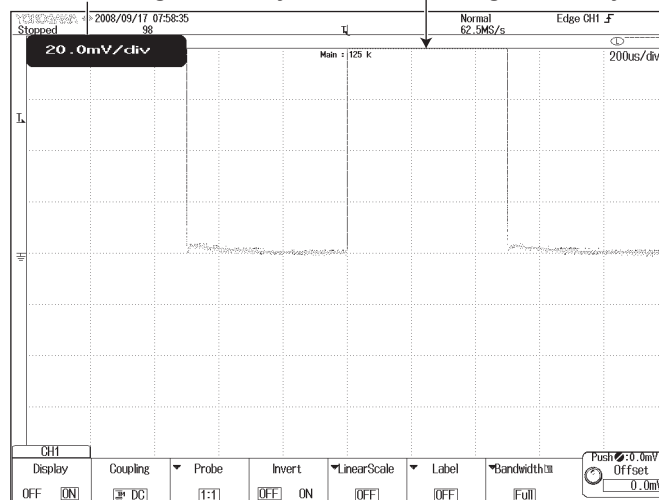

Note

If you change the scale with the SCALE knob while waveform acquisition is stopped, the waveform is displayed expanded or reduced along the vertical axis.

Decreasing the Vertical Position to View the Entire Waveform

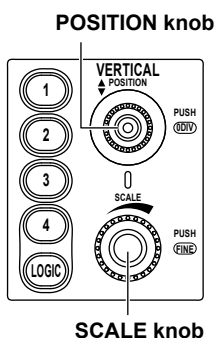

1. Use the **POSITION** knob to change the vertical position to -2.00 div. The value of the new vertical position appears.

If you press the **POSITION** knob, the position returns to 0.00 div.

Vertical position value

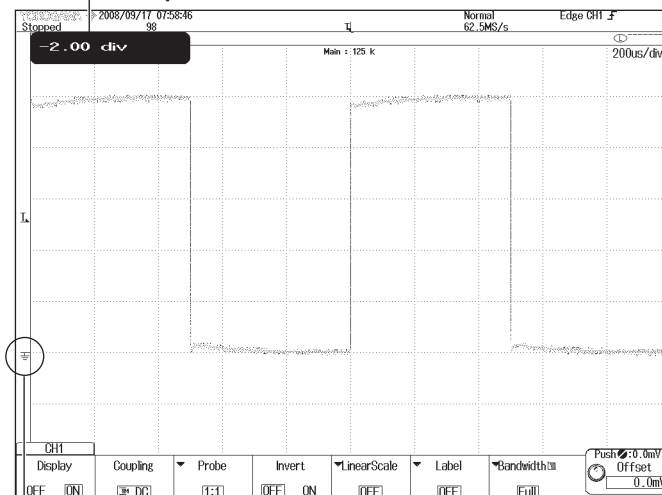

Ground level also moves.

Changing the Time Scale from 200 $\mu\text{s}/\text{div}$ to 100 ms/div

The time scale refers to the time per division of the grid.

If you increase the time scale when the trigger mode is set to Auto or Auto Level, the DLM2000 switches from update display mode, in which a stationary waveform is updated, to roll mode display, in which waveforms flow from the right to the left of the screen.

Roll mode display is useful for observing signals with a long period or signals that change slowly.

1. Use the **TIME/DIV** knob to set the Time/div setting to 100 ms/div .

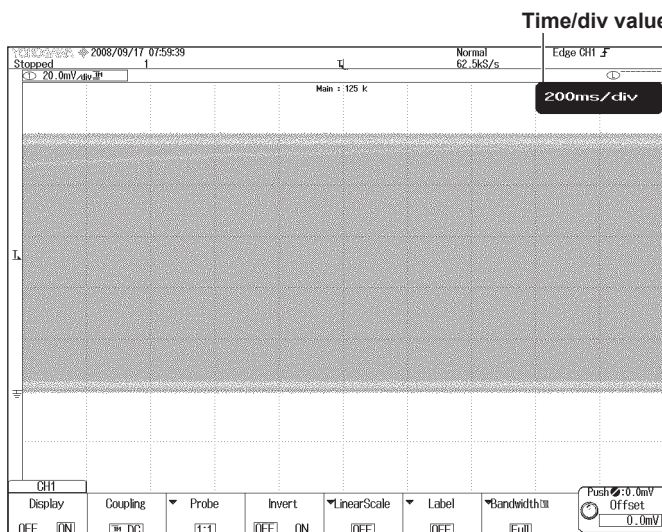
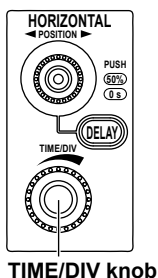

Note

If you change the time/div setting while waveform acquisition is stopped, the waveform is displayed expanded or reduced along the time axis.

Changing the Time Scale from 100 ms/div to 500 $\mu\text{s}/\text{div}$

The DLM2000 switches back from roll mode display to update mode display, and five periods of the waveform appear.

1. Use the **TIME/DIV** knob to set the Time/div setting to 500 $\mu\text{s}/\text{div}$.

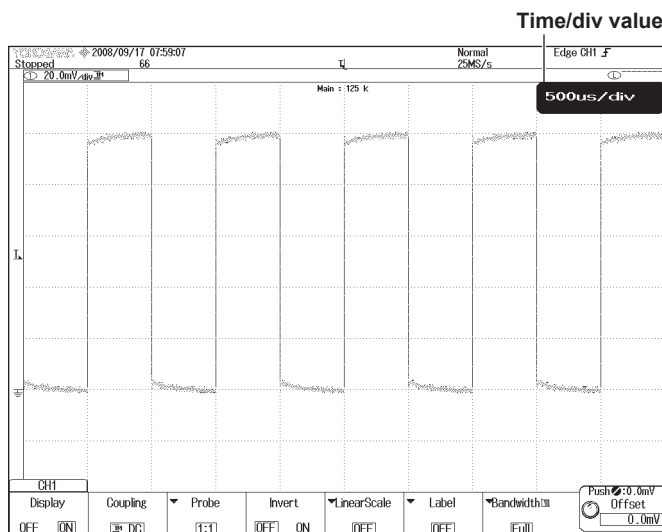
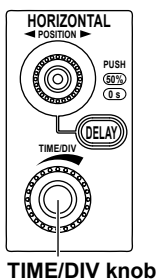

4.3 Changing the Trigger Settings

The trigger settings determine which part of the acquired waveform to display. The main trigger settings are listed below.

Trigger type

Triggers can be classified into edge triggers and enhanced triggers.

Trigger source

The trigger source is the signal that is used to check for the trigger condition.

Trigger slope

Slope refers to the signal movement, such as from a low level to a high level (rising slope) or from a high level to a low level (falling slope). When the slope is used as one of the trigger conditions, it is called a trigger slope. An edge refers to a point where the trigger source slope passes through the trigger level.

Trigger level

Trigger level refers to the level that the trigger source must pass through to trigger the DLM2000. With simple triggers such as the edge trigger, the DLM2000 triggers when the trigger source level passes through the specified trigger level.

Trigger mode

The trigger mode that you select specifies the conditions (timing or count) for updating the displayed waveforms. If you execute auto setup, the DLM2000 is set to Auto mode.

Trigger position

When you start waveform acquisition, the DLM2000 triggers on the set trigger condition and displays the waveforms stored in the acquisition memory. By moving the trigger position, the ratio of the displayed data before the trigger point (the pre-trigger section) and the data after the trigger point (the post-trigger section) can be changed. The default setting is 50.0% (the screen center).

If you initialize the DLM2000 settings or execute auto setup, the trigger type is set to edge trigger (the trigger is set to CH1). With edge triggers, the DLM2000 triggers on the rising or falling edge of a single input signal.

This section explains how to change the trigger slope and trigger position, with the trigger type set to edge trigger.

Note

The DLM2000 allows you to use trigger combinations, which are combinations of two triggers.

If the front-panel B TRIG key is illuminated, a combination trigger is enabled.

If you want to trigger the DLM2000 using only an edge trigger or enhanced trigger, check that the B TRIG key is not illuminated. If the key is illuminated, set Combination to OFF using the B TRIG menu.

Changing the Trigger Slope from Rising to Falling

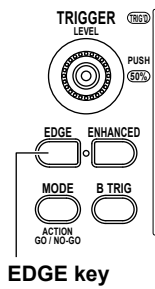

1. Press **EDGE** key.
2. Set Slope to falling (↓).

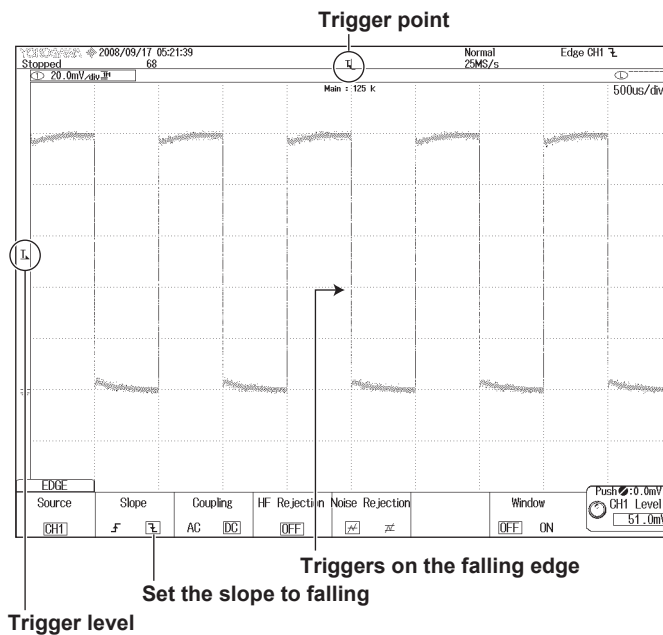

Changing the Trigger Position to 30%

Follow the procedure below to move the waveform to the left by 20% (2 divisions) so that you can view more of the post-trigger section of the waveform.

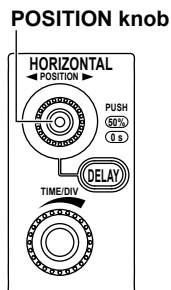

1. Turn the **POSITION** knob under HORIZONTAL to change the trigger position from 50% to 30%.

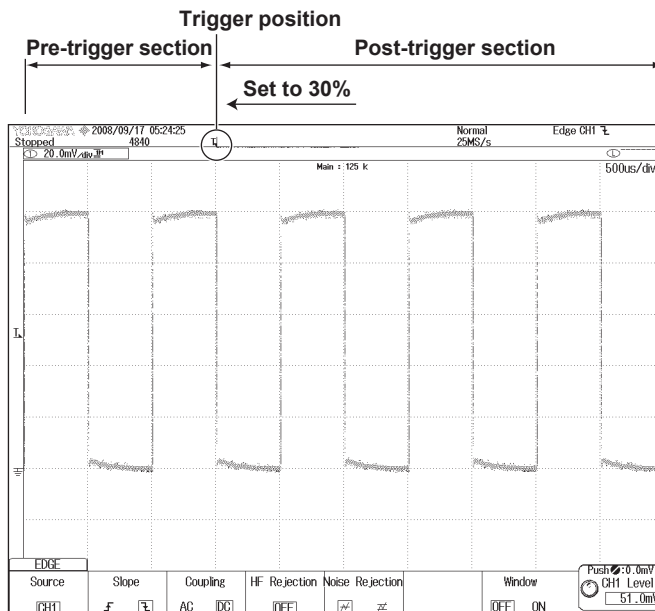

Note

- Set the trigger position as a percentage from the left end of the screen. The screen center is 50%.
- Press the POSITION knob to set the trigger point to 50%.

4.4 Measuring the Waveform

This section explains how to use vertical cursors to measure the displayed waveform's voltages and its period. Other convenient features such as computation and the automated measurement of waveform parameters can also be used to measure pulse and other periodic waveforms.

Measuring Voltages Using Vertical Cursors

The voltages (Y values) and times (X values) at the cursor positions are displayed at the bottom section of the waveform display frame.

1. Press **CURSOR** to display cursors.
2. Press the **Type** soft key to select ΔT .
3. Use the **jog shuttle** and **SET key** (\odot) to move the cursors.

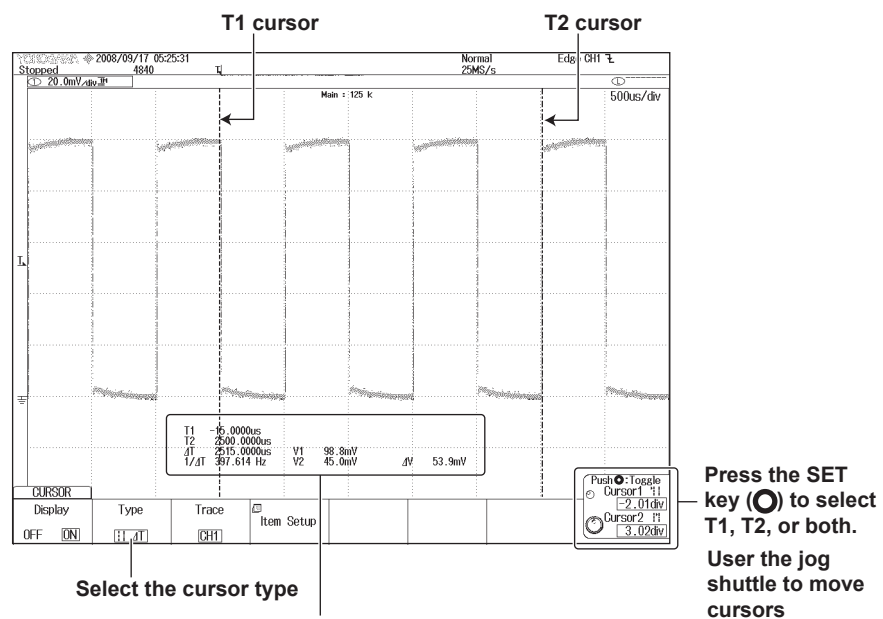

- T1:** T1 cursor X value
- T2:** T2 cursor X value
- ΔT :** The difference between the X values of T1 cursor and T2 cursor
- $1/\Delta T$:** The inverse of the difference between the X values of T1 cursor and T2 cursor
- V1:** Waveform voltage value at the T1 cursor position
- V2:** Waveform voltage value at the T2 cursor position
- ΔV :** The difference between V1 and V2

There are five cursor types.

- ΔT cursors: Two ΔT cursors are used to measure time values.
- ΔV cursors: Two ΔV cursors are used to measure vertical values.
- ΔT & ΔV cursors: Two ΔT cursors and two ΔV cursors are used to measure time and vertical values.
- Marker cursors (Marker): Four marker cursors that move on the waveform are used to measure waveform values.
- Angle cursors (Degree): Two angle cursors are used to measure angles.

4.5 Zooming in on or out from the Waveform

You can expand or reduce a section of the displayed waveform along the time axis. The zoomed waveforms of two locations can be displayed along with the normal waveform. When zoom waveforms are displayed, zoom boxes appear in the normal waveform display frame to indicate the zoom positions.

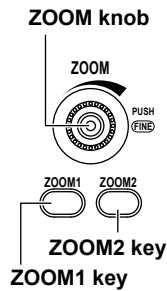

1. Press **ZOOM1** or **ZOOM2** key to display a zoom waveform.
2. Use the **SET** key (○) to select the item whose zoom position you want to change, and then use the **jog shuttle** to move the zoom box.

You can change the decimal place of the zoom location value by moving the SET key to the left and right.

3. Use the **ZOOM** knob to set the magnification.

Press the **ZOOM** knob to set the magnification in fine detail (FINE illuminates).

The ZOOM knob controls the zoom waveform whose corresponding panel key (ZOOM1 or ZOOM2) is illuminated brightly.

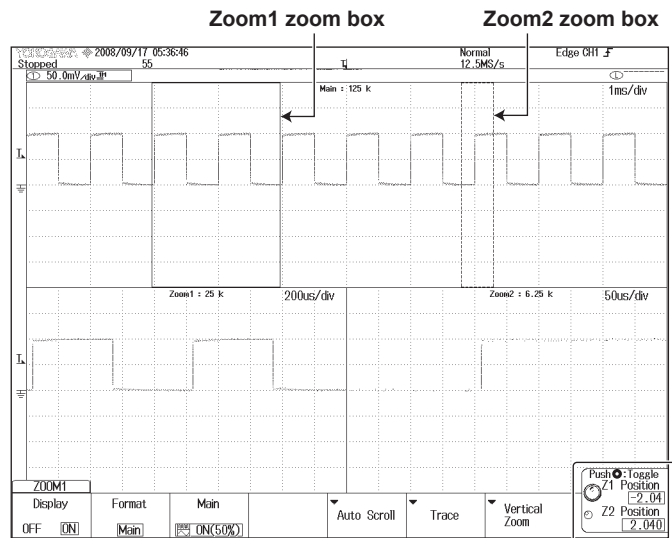

Press the **SET** key (○) to select Z1 or Z2 (both Z1 and Z2 can also be selected.)
Use the jog shuttle to move the zoom position

Note

The ZOOM knob controls the waveforms in the window whose corresponding key, ZOOM1 or ZOOM2, is illuminated.

If both keys are illuminated, the ZOOM knob controls the waveforms in the window whose corresponding key is illuminated more brightly.

4.6 Printing and Saving the Waveform

This section explains how to print the displayed waveform on the built-in printer (/B5 option) and how to save measured data or a screen capture to a storage medium.

Printing a Screen Capture on the Built-in Printer

Follow the procedure below to print a screen capture of the waveform. Before you print, follow the procedure in section 16.1 in the User' Manual (on the CD-ROM) to load roll paper into the built-in printer.

1. Press **SHIFT** key, and then press **PRINT (MENU)** key.
2. Press the **Print To** soft key to set the destination to BuiltIn.
3. Press the **Mode** soft key to set the print format.
HardCopy: Prints a screen capture that includes the setup menu.
Normal: Prints a screen capture, excluding the setup menu.
Long: Prints a screen capture by magnifying it 2 to 10 times along the time axis.
4. Press **PRINT (MENU)** again.

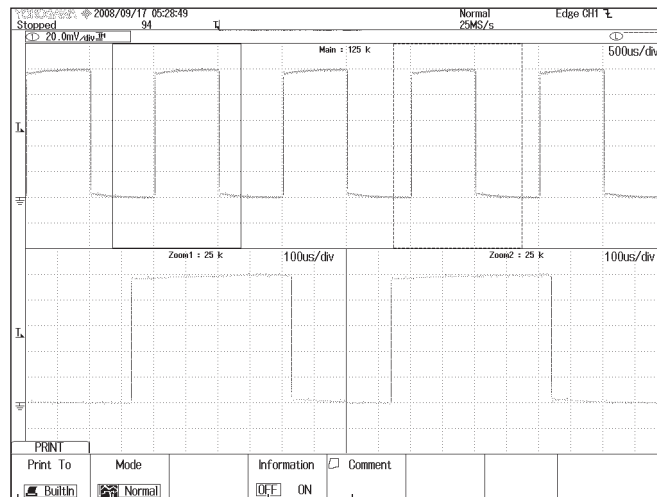

Set the print destination to BuiltIn
Set the print mode
Turn the printing of additional information on or off
Set comments

Saving Screen Capture Data to a Storage Medium

Follow the procedure below to capture the current screen and save it to a file on a storage medium.

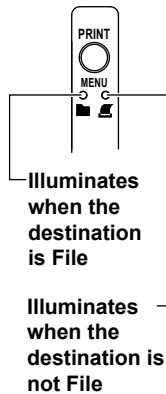

1. Press **SHIFT** key, and then press **PRINT (MENU)** key.
2. Press the **Print To** soft key to set the destination to File.
3. Press the **Mode** soft key to set the save format.
HardCopy: Saves a screen capture that includes the setup menu.
Normal: Saves a screen capture, excluding the setup menu.
Wide: Saves a screen capture by magnifying it two times along the time axis.
4. Press the **Format** soft key to set the data format.
5. Press the **Color** soft key to set the color.
6. Press the **Background** soft key to set the background to transparent or opaque.
7. Press the **File List** soft key to set the save destination medium and folder.
8. Press the **File Name** soft key to set the save destination file name. If you do not set the file name, a sequence number is used for the file name.
9. Press the **PRINT (MENU)**.

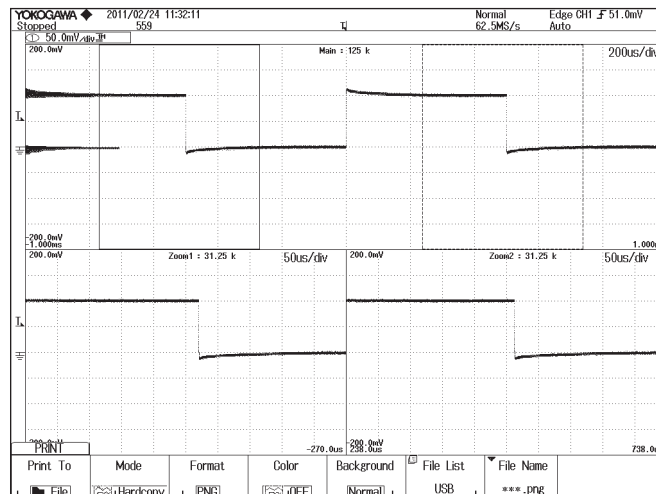

Set the print destination to File

Set the save mode

Set the data format

Set the color

Set the background

Set the save destination medium

Set the file name

Saving Measured Data to a Storage Medium

Follow the procedure below to save waveform data displayed on the screen to a storage medium. The vertical, horizontal, and trigger settings for the waveform are also saved in this process.

1. Press **File** key.
2. Press the **Waveform** soft key under Save.
3. Press the **File List** soft key to set the storage destination medium and folder.
4. Press the **File Name** soft key to set the save destination file name. If you do not set the file name, a sequence number is used for the file name.
5. Press the **Data Type** soft key to set the data format. The data type that the DLM2000 can load is binary.
6. Press the **Trace** soft key to set the waveform you want to save.
7. Press the **History** soft key to set which range of history waveforms to save.
8. Press the **Range/Compression** soft key to set the window to be saved and data compression.
9. Press the **Save Waveform** soft key to save the waveform.

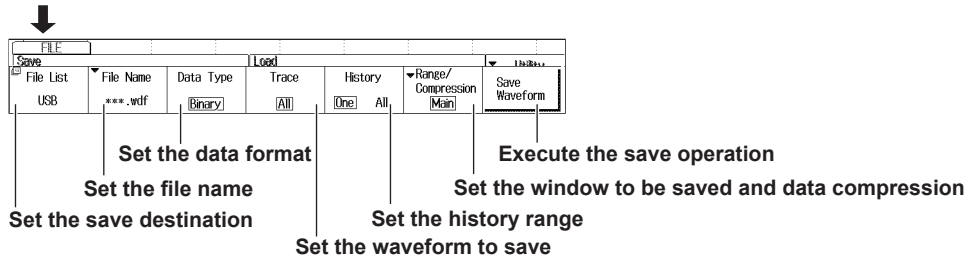
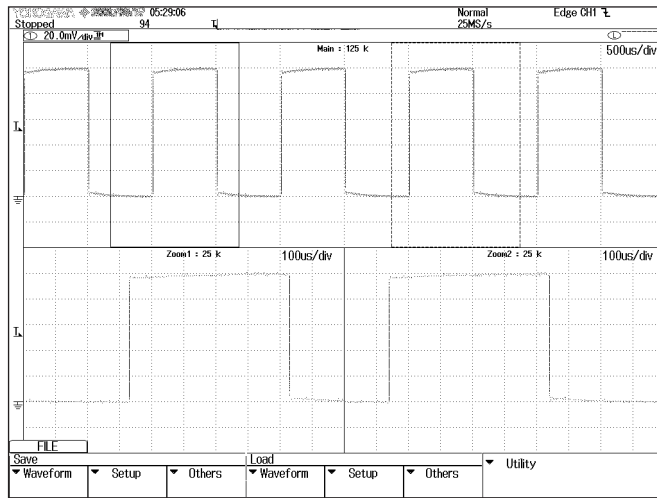

5.1 Signal Input Section

Analog Signal Input

Item	Specifications		
Number of input channels	DLM2022(710105), DLM2032(710115), DLM2052(710125): 2 (CH1 and CH2) DLM2024(710110), DLM2034(710120), DLM2054(710130): 4 (CH1 to CH4)		
Input coupling settings	AC1M Ω , DC1M Ω , DC50 Ω , and GND		
Input connector	BNC connector		
Input impedance	1 M Ω \pm 1.0%, approx. 20 pF 50 Ω \pm 1.0% (VSWR1.4 or less at DC to 500 MHz)		
Selectable voltage sensitivity range	1 M Ω input: 50 Ω input:	2 mV/div to 10 V/div (in 1-2-5 steps) 2 mV/div to 500mV/div (in 1-2-5 steps)	
Maximum input voltage	1 M Ω input: 50 Ω input:	150 Vrms (At 100 kHz and higher, the voltage decreases at 20 dB/decade down to 2.5 Vrms.) 5 Vrms or less and 10 Vpeak or less	
Selectable maximum DC offset range (When the probe attenuation is set to 1:1)	1 M Ω input 2 mV/div to 50 mV/div: 100 mV/div to 500 mV/div: 1 V/div to 10 V/div: 50 Ω input 2 mV/div to 50 mV/div: 100 mV/div to 500 mV/div:	\pm 1 V \pm 10 V \pm 100 V \pm 1 V \pm 5 V	
Vertical-axis (voltage-axis) accuracy			
DC accuracy ¹	\pm (1.5% of 8 divisions + offset voltage accuracy)		
Offset voltage accuracy ¹	2 mV/div to 50 mV/div: 100 mV/div to 500 mV/div: 1 V/div to 10 V/div:	\pm (1% of set value + 0.2 mV) \pm (1% of set value + 2 mV) \pm (1% of set value + 20 mV)	
Frequency Bandwidth (≥ -3 dB) ^{1,2} (When sine wave with amplitude ± 3 div _{p-p} equivalent is input)	1 M Ω input (measured from the probe tip when using the supplied 10:1 probe (10:1 conversion)) 100 V/div to 100 mV/div: 50 mV/div to 20 mV/div: 50 Ω input 500 mV/div to 10 mV/div: 5 mV/div to 2 mV/div:	DLM2022/ DLM2024 DC to 200 MHz DC to 150 MHz	DLM2032/ DLM2034 DC to 350 MHz DC to 300 MHz
		DLM2052/ DLM2054 DC to 500 MHz DC to 400 MHz	
		DC to 200 MHz DC to 150 MHz	DC to 350 MHz DC to 300 MHz DC to 500 MHz DC to 400 MHz
-3 dB point for AC coupling	10 Hz or less (1 Hz or less when using the supplied 10:1 probe)		
Skew between channels (when channels are set to the same conditions)	1 ns or less		
Residual noise level ³	0.4 mVrms or 0.05 divisions rms, whichever is greater (typical value ⁴)		
Isolation between channels (when set to the same voltage sensitivity)	Maximum bandwidth: -34 dB (typical value ⁴)		
A/D converter resolution	8 bits (25 LSB/division) 12 bits maximum (during high-resolution mode)		
Probe attenuation settings	Voltage probe: Current probe:	0.001:1 to 2000:1 (in 1-2-5 steps) 0.001A:1V to 2000A:1V (in 1-2-5 steps)	
Bandwidth limit	For each channel, can be set to FULL, 200 MHz, 100 MHz, 20 MHz, 10 MHz, 5 MHz, 2 MHz, 1 MHz, 500 kHz, 250 kHz, 125 kHz, 62.5 kHz, 32 kHz, 16 kHz, or 8 kHz. Uses IIR and FIR digital filters		
Maximum sample rate	Real-time sampling mode. Values inside parentheses are for high resolution mode ² When interleave mode is on: 2.5 GS/s (1.25 GS/s) When interleave mode is off: 1.25 GS/s (625 MS/s) Repetitive sampling mode: 125 GS/s Interpolation sampling mode: 125 GS/s		

5.1 Signal Input Section

Item	Specifications
Maximum record length	Maximum record length for which repetitive acquisitions are possible
	No options: 1.25 M points On models with the /M1 option: 6.25 M points On models with the /M2 option: 12.5 M points On models with the /M3 option: 25 M points
Maximum record length for which a single acquisition is possible. Values inside parentheses apply when interleave mode is on.	No options: 6.25 M points (12.5 M points)
	On models with the /M1(S) option: 25 M points (62.5 M points)
	On models with the /M2 option: 62.5 M points (125 M points)
	On models with the /M3 option: 125 M points (250M points)

- 1 Values measured under standard operating conditions (see section 5.11 for details) after a 30-minute warm-up and calibration.
- 2 Values for repeating phenomena.
The single-shot frequency bandwidth is from DC to the sampling frequency/2.5 or is the frequency bandwidth of the repeating phenomena, whichever is less.
- 3 Values when the input section is shorted, the acquisition mode is set to Normal, accumulation is set to off, and the probe attenuation is set to 1:1.
- 4 Typical values represent typical or average values. They are not strictly warranted.

Logic Signal Input

Item	Specifications
Usable probes	701980, 701981, 701988, 701989 (8-bit input)
Number of inputs	8
Nondestructive maximum input voltage	701980, 701981, 701989: ± 40 V (DC + ACpeak) or 28 Vrms
	701988: ± 42 V (DC + ACpeak) or 29 Vrms
For information about derating based on frequency, see the respective logic probe user's manual.	
Input range	When using the 701980 ± 40 V When using the 701981 ± 10 V When using the 701988 ± 40 V When using the 701989 Threshold level ± 6 V
Minimum input voltage	500 mVp-p 500 mVp-p 500 mVp-p 300 mVp-p
Maximum toggle frequency ¹	100 MHz 250 MHz 100 MHz 250 MHz
Input impedance (typical value ³)	1 M Ω /approx. 10 pF 10 k Ω /approx. 9pF 1 M Ω /approx. 10 pF Approx. 100 k Ω /approx. 3 pF
Variable threshold level range	± 40 V ± 10 V ± 40 V ± 6 V
Threshold level setting	Same value for all 8 bits Same value for all 8 bits Same value for all 8 bits Different values for each of the 8 bits
Threshold level resolution	0.1 V 0.1 V 0.05 V 0.05 V
Threshold level accuracy ¹	$\pm(0.1$ V + 3% of setting) $\pm(0.1$ V + 3% of setting) $\pm(0.1$ V + 3% of setting) $\pm(0.1$ V + 3% of setting)
Hysteresis voltage (typical value ³)	80 mV 50 mV 100 mV When noise rejection is off: 100 mV When noise rejection is on: 250 mV
Minimum pulse width	5 ns 2 ns 5 ns 2 ns
Maximum sample rate	Real-time sampling mode. Values inside parentheses are for high resolution mode ²
	When interleave mode is on: Unable to acquire logic waveforms
	When interleave mode is off: 1.25 GS/s (625 MS/s)
	Repetitive sampling mode: 125 GS/s
	Interpolation sampling mode: 125 GS/s (Pulse interpolation for logic waveforms)
Maximum record length	Maximum record length for which repetitive acquisitions are possible
	No options: 1.25 M points
	On models with the /M1 option: 6.25 M points
	On models with the /M2 option: 12.5 M points
	On models with the /M3 option: 25 M points
Maximum record length for which a single acquisition is possible.	No options: 6.25 M points
	On models with the /M1 option: 25 M points
	On models with the /M2 option: 62.5 M points
	On models with the /M3 option: 125 M points

- 1 Under standard operating conditions (see section 5.11 for details) after a 30-minute warm-up.
- 2 Resolution only improves for analog waveforms.
- 3 Typical values represent typical or average values. They are not strictly warranted.

5.2 Triggering Section

Item	Specifications
Trigger modes	Auto, Auto Level, Normal, Single, N Single The DLM2000 measures in Single mode when you start acquisition by pressing the SINGLE key or when you start acquisition by pressing the RUN/STOP key when the record length setting only allows for single acquisition.
Trigger sources	CH1 to CH4 ¹ Signals received through input terminals LINE: The connected commercial power supply signal (only Edge trigger can be used) EXT: The signal received through the TRIG IN terminal (EXT. terminal on the DLM2022, DLM2032, and DLM2052) Logic bits 0 to 7 ² Signals received through the logic signal input port terminals
Trigger coupling	CH1 to CH4: ¹ DC/AC EXT: DC
HF rejection	Trigger source bandwidth limit can be specified separately for CH1 to CH4. ¹ OFF: No bandwidth limit 15 kHz: DC to approximately 15 kHz 20 MHz : DC to approximately 20 MHz
Noise rejection	Noise rejection can be turned on or off (trigger level hysteresis can be selected) for CH1 to CH4 ¹ separately. Noise rejection cannot be specified on channels set to TV trigger. OFF: Approximately 0.3 divisions* of hysteresis ON: Approximately 1.0 divisions* of hysteresis
Selectable trigger level range	CH1 to CH4: ¹ ±4 divisions from the screen center EXT: ±2 V (DLM2024, DLM2034, DLM2054) ±1 V (±1 V range on the DLM2022, DLM2032, DLM2052) ±10 V (±10 V range on the DLM2022, DLM2032, DLM2052)
Trigger level resolution	CH1 to CH4: ¹ 0.01 divisions (0.1 divisions for TV triggers) EXT: 5 mV (DLM2024, DLM2034, DLM2054) 5 mV (±1 V range on the DLM2022, DLM2032, DLM2052) 50 mV (±10 V range on the DLM2022, DLM2032, DLM2052)
Trigger level accuracy	CH1 to CH4: ^{1,3} ±(0.2 divisions + 10% of the trigger level) EXT: ⁴ ±(50 mV + 10% of the trigger level) for DLM2024, DLM2034, DLM2054 ±(50 mV + 10% of the trigger level) for the ±1 V range on the DLM2022, DLM2032, DLM2052 ±(500 mV + 10% of the trigger level) for the ±10 V range on the DLM2022, DLM2032, DLM2052
Window comparator setting	Window comparator can be turned on or off for CH1 to CH4 ¹ separately OFF: Normal comparator Edge polarities: Rise and Fall. Qualifications: H, L, and X. ON: Window comparator Edge polarities: Enter and Exit. Qualifications: IN, OUT, and X.
Selectable window trigger level range	CH1 to CH4 ¹ separately Center: ±4 divisions from the screen center Width: ±4 divisions around the center
Window trigger level accuracy	The following trigger level accuracy applies to the upper and lower limits of the window that are specified using the Center and Width settings. The upper and lower limits are set separately for CH1 to CH4. ¹ ±(0.2 divisions + 10% of the trigger level) However, the accuracy does not apply to an upper or lower limit that falls outside ±4 divisions from the screen center.
External trigger probe attenuation setting	1:1, 10:1
Trigger sensitivity	CH1 to CH4 ¹ : 1 div _{P-P} DC to the maximum bandwidth (with noise rejection set to off) EXT: 100 mV _{P-P} DC to 100 MHz (DLM2024, DLM2034, DLM2054) 100 mV _{P-P} DC to 100 MHz (±1 V range on the DLM2022, DLM2032, DLM2052) 1 V _{P-P} DC to 100 MHz (±10 V range on the DLM2022, DLM2032, DLM2052)
Trigger position	Can be set as a percentage of the display record length in 0.1% steps

5.2 Triggering Section

Item	Specifications
Selectable trigger delay range	-(Time length of the post-trigger section) to 10 s
Selectable hold-off time range	20 ns to 10 s
Trigger type (A trigger)	<p>Edge: Triggers on the edge of a single trigger source The source can be set to a signal from CH1 to CH4,¹ from logic bits 0 to 7,² EXT, or LINE.</p> <p>Edge OR: Triggers when any of the edge trigger conditions of multiple trigger sources is met Sources can be set to channels from CH1 to CH4.¹</p> <p>Edge Qualified: Triggers on the edge of a single trigger source while qualifications are met The source can be set to a signal from CH1 to CH4,¹ from logic bits 0 to 7,² or EXT. Qualifications can be specified for CH1 to CH4¹ and for logic bits 0 to 7.²</p> <p>State: Triggers when the state condition changes from met to not met or from not met to met State conditions can be applied to all sources using AND or OR. A clock channel can be specified that is used to determine the met or not met state condition. No clock can also be selected. The source and state clock can be set to a signal from CH1 to CH4¹ or from logic bits 0 to 7.²</p> <p>Pulse Width: Triggers on the width of a single trigger source The source can be set to a signal from CH1 to CH4,¹ from logic bits 0 to 7,² or EXT.</p> <p>more than: Triggers when the time length during which the condition is met is longer than Time1, and the condition changes to not met Time1: 4 ns to 10 s in 2-ns steps</p> <p>less than: Triggers when the time length during which the condition is met is shorter than Time1, and the condition changes to not met Time1: 6 ns to 10 s in 2-ns steps</p> <p>between: Triggers when the time length during which the condition is met is longer than Time1 but shorter than Time2 and the condition changes to not met Time1: 4 ns to (10 s – 4 ns) in 2-ns steps Time2: 8 ns to 10 s in 2-ns steps Minimum spacing between Time1 and Time2: 4 ns</p> <p>out of range: Triggers when the time length during which the condition is met is shorter than Time1 or longer than Time2 and the condition changes to not met Time1: 6 ns to (10 s – 4 ns) in 2-ns steps Time2: 8 ns to 10 s in 2-ns steps Minimum spacing between Time1 and Time2: 4 ns (2 ns only when Time1 = 6 ns and Time2 = 8 ns)</p> <p>time out: Triggers when the time length during which the condition is met exceeds Time1. Time1: 4 ns to 10 s in 2-ns steps</p> <p>Time accuracy:⁴ ±(0.5% of setting + 2 ns) Minimum time 2 ns (typical value⁵) detection width:</p> <p>State Width: Triggers on the time-duration for which the state condition is met or not met For a description of the state conditions, see "State Pattern." The source and state clock can be set to a signal from CH1 to CH4¹ or from logic bits 0 to 7.² For details on the time settings, see "Pulse Width."</p> <p>FlexRay:⁶ Triggers on a FlexRay bus signal The source can be set to a signal from CH1 to CH4. Modes: Frame Start, Error, ID/Data, ID OR Bit Rate: 2.5 M, 5 M, 10 Mbps Bus channels: A, B</p> <p>CAN:⁶ Triggers on a CAN (Controller Area Network) bus signal The source can be set to a signal from CH1 to CH4. Modes: SOF, Error, ID/Data, ID OR Bit Rate: 33.3 k, 83.3 k, 125 k, 250 k, 500 k, 1 Mbps, User Define For User Define, you can set a value from 10 k to 1 Mbps in 0.1-kbps steps.</p>

Item	Specifications
CAN FD: ⁶	<p>Triggers on CAN FD bus signals</p> <p>The source can be set to a signal from CH1 to CH4.</p> <p>Modes: SOF, Error Frame, ID, ID OR</p> <p>Bit Rate: Arbitration phase 250 k, 500 k, 1 Mbps, User Define For User Define, you can set a value from 20 k to 1 Mbps in 0.1-kbps steps.</p> <p>Data phase 500 k, 1 Mbps, 2 Mbps, 4 Mbps, 5 Mbps, 8 Mbps, User Define For User Define, you can set a value from 250 k to 10 Mbps in 0.1-kbps steps.</p>
LIN: ⁶	<p>Triggers on a LIN (Local Interconnect Network) bus signal</p> <p>The source can be set to a signal from CH1 to CH4.</p> <p>Modes: Break Synch, Error, ID/Data, ID OR</p> <p>Bit Rate: 1200, 2400, 4800, 9600, 19200 bps, User Define For User Define, you can set a value from 1 k to 20 kbps in 0.01-kbps steps.</p>
SENT: ⁶	<p>Triggers on SENT signals (J2716 JAN2010 and earlier)</p> <p>The source can be set to a signal from CH1 to CH4 or from logic bits 0 to 7.²</p> <p>Modes: Every Fast CH</p> <p>Clock period: 1 μs to 100 μs (resolution: 0.01 μs)</p>
PSI5 Airbag: ⁶	<p>Triggers on PSI5 Airbag signal</p> <p>The source can be set to a signal from CH1 to CH4.</p> <p>Mode: Sync, Start Bit, Data</p> <p>Bit Rate: 125kbps, 189kbps, User Define For User Define, you can set a value from 10.0 k to 1000.0 kbps in 0.1-kbps steps.</p>
UART: ⁶	<p>Triggers on a UART (RS232) signal</p> <p>The source can be set to a signal from CH1 to CH4 or from logic bits 0 to 7.²</p> <p>Modes: Every Data, Error, Data</p> <p>Formats: 8-bit data (no parity bit), 7-bit data + parity bit, 8-bit data + parity bit</p> <p>Bit Rate: 1200, 2400, 4800, 9600, 19200 bps, 38400 bps, 57600 bps, 115200 bps, User Define For User Define, you can set a value from 1 k to 1000 kbps in 0.1-kbps steps.</p>
I2C: ⁶	<p>Triggers on an I2C bus signal.</p> <p>The source can be set to a signal from CH1 to CH4 or from logic bits 0 to 7.²</p> <p>Modes: Every Start, Adr Data, NON ACK, General Call, Start byte, HS Mode</p>
SPI: ⁶	<p>Triggers on an SPI (Serial Peripheral Interface) bus signal</p> <p>The source can be set to a signal from CH1 to CH4 or from logic bits 0 to 7.²</p> <p>Modes: 3wire, 4wire</p>
User Define:	<p>Triggers on a general-purpose serial communication signal</p> <p>The source can be set to a channel from CH1 to CH4.¹</p> <p>Data channel, chip select channel, clock channel, and latch channel can be specified.</p> <p>Bit Rate: 1 k to 200 Mbps (with clock) 1 k to 49.5 Mbps (without clock)</p> <p>Data Size: 1 to 128 bits</p>

1 CH1 and CH2 on the DLM2022, DLM2032, and DLM2052.

2 Logic only available on the DLM2024, DLM2034, and DLM2054.

3 Values measured under standard operating conditions (see section 5.11 for details) after a 30-minute warm-up and calibration.

4 Values measured under standard operating conditions (see section 5.11 for details) after a 30-minute warm-up.

5 Typical values represent typical or average values. They are not strictly warranted.

6 FlexRay, CAN, CAN FD, LIN, SENT, PSI5, UART, I2C, and SPI are options for 4-channel models.

5.2 Triggering Section

Item	Specifications
	<p>TV: Triggers on the specified field number, line number, or polarity in video signals of various broadcasting systems. The source can be set to a channel from CH1 to CH4.¹</p> <p>Mode: NTSC: Triggers on an NTSC (525/60/2) signal PAL: Triggers on a PAL (625/50/2) signal SDTV: Triggers on an SDTV (480/60p) signal HDTV: Triggers on the following HDTV signals 1080/60p, 1080/60i, 1080/50ip, 1080/25p, 1080/24p, 1080/24sF, 720/60</p> <p>USER Def: You can trigger on any TV signal by selecting standard or high definition, setting the H sync period, and setting the sync guard. Sync guard can be set to a value from 60 to 90% of the H sync value in 1% steps.</p> <p>Polarity: Pos, Neg</p> <p>HF Rej: NTSC/PAL: 300 kHz (fixed) SDTV/HDTV: OFF (fixed) User Def: Off or 300 kHz</p> <p>Line: 5 to 1054 (NTSC), 2 to 1251 (PAL), 8 to 2251 (SDTV), 2 to 2251 (HDTV), 2 to 2251 (USER), ALL</p> <p>Field: 1, 2, X</p> <p>Frame Skip: 1, 2, 4, 8</p>
AB trigger	<p>Able to trigger on the combination of triggers A and B Some trigger types cannot be specified depending on the AB trigger type as shown below. (see Trigger Type (A trigger))</p> <p>OFF: Triggers only on the trigger A conditions (the trigger B conditions are not used).</p> <p>A Delay B: After the trigger A conditions are met and the specified amount of time elapses, the DLM2000 triggers when the trigger B conditions are met. Trigger B cannot be set to Edge OR, Width, CAN FD, SENT, PSI5 Airbag, or TV. Delay value: 10 ns to 10 s</p> <p>A to B(N): After the trigger A conditions are met, the DLM2000 triggers when the trigger B conditions are met N times. Trigger B cannot be set to Edge OR, Width, CAN FD, SENT, PSI5 Airbag, or TV. N value: 1 to 10⁹</p> <p>Dual Bus: The DLM2000 triggers when condition A or B of the serial bus trigger (except CAN FD, SENT and PSI5 Airbag) is met.</p>

5.3 Time Axis

Item	Specifications
Selectable time scale range	1 ns/division to 500 s/division
Timebase accuracy*	±0.002%
Time measurement accuracy*	±(0.002% + 50 ps + 1 sample period)

* Values measured under standard operating conditions (see section 5.11 for details) after a 30-minute warm-up.

5.4 Display

Item	Specifications
Display	8.4-inch (21.3-cm) color TFT LCD*
Display screen size	171.264 mm (horizontal) × 128.488 mm (vertical)
Resolution of the entire screen	1024 × 768 (XGA)
Resolution of the waveform display	1000 × 640

* The LCD may include a few defective pixels (within 4 ppm over the total number of pixels including RGB). The LCD may contain some pixels that are always lighted or that never light. Please be aware that these are not defects.

5.5 Features

Vertical and Horizontal Control

Item	Specifications
Channel on/off	CH1 to CH4 ¹ and LOGIC can be turned on and off separately. Either CH4 or LOGIC ² can be turned on at any given time. When interleave mode is on, all even-numbered channels (including LOGIC ²) are automatically are turned off.
Logic waveform bus display	Bus display can be used for logic waveform bits 0 to 7. The bus display shows the logic signal according to the specified format (Format) and bit order (Bit Order).
Vertical position setting	Analog waveforms: Waveforms can be moved in the range of ±4 divisions from the center of the waveform display frame. Logic waveforms: ² The center of logic waveforms can be moved in the range of ±4 divisions from the center of the waveform display frame. Press the vertical position knob to reset the position to its default value (0 divisions).
Vertical scale settings	The vertical scale knob allows you to set the vertical scale. Press the knob to switch between coarse and fine. For the selectable range when using Coarse adjustment, see "Analog Input Section" in section 5.1, "Signal Input Section." Fine vertical sensitivity is achieved through digital zooming. If you change the scale while the DLM2000 is stopped, you can vertically expand or reduce waveforms. Logic waveforms ² can be expanded to three different display-size levels.
Input filtering	Bandwidth limit can be specified for CH1 to CH4 ¹ separately. For the available filter types, see "Bandwidth limit" in section 5.1, "Signal Input Section."
Offset cancelling	Can be set to on or off for CH1 through CH4 ¹ . OFF: Does not apply the specified offset to the result of cursor measurements, computations, and automated measurement of waveform parameters. ON: Applies the specified offset to the result of cursor measurements, computations, and automated measurement of waveform parameters.
Inverted display	Waveforms can be inverted around the vertical position for CH1 to CH4 ¹ separately. Configuration and measurement are executed on the waveforms before the inversion.
Linear scaling	Scaling coefficient, offset value, and unit can be specified for CH1 to CH4 ¹ separately.

5.5 Features

Item	Specifications
Logic channel threshold level preset	You can choose from the following preset threshold level settings. CMOS (5V) = 2.5 V, CMOS (3.3V) = 1.65 V, CMOS (2.5V) = 1.25 V, CMOS (1.8V) = 0.90 V, ECL = -1.30 V
Deskewing	The waveform display position can be adjusted for CH1 to CH4 ¹ and LOGIC ² separately. Trigger skew cannot be adjusted. Logic waveforms can be adjusted at the pod (8-bit) level. Adjustment at the bit level is not possible. The adjustable range is ± 100 ns in 0.01-ns steps.
Horizontal position setting	Horizontal position knob can be used to set the trigger position and trigger delay. What the knob controls is indicated by the DELAY key LED. LED off: Trigger position LED on: Trigger delay For trigger position and trigger delay specification details, see "Trigger position" or "Trigger delay" in section 5.2, "Triggering Section."
Delay cancelling	You can select whether or not to apply the specified delay to the time measurement values. ON: Measures time with the trigger position set to 0 s (does not apply the delay to time measurement). OFF: Measures time with the trigger point set to 0 s (applies the delay to time measurement).
Time scale setting	The TIME/DIV knob can be used to set the time scale. For the selectable range, see "Selectable time scale range" in section 5.3, "Time Axis." If you change the time scale while the DLM2000 is stopped, you can expand or reduce waveforms along the time axis.
Roll mode	The DLM2000 switches to roll mode display when the trigger mode is set to Auto, Auto Level, or Single for the following time scale ranges. For details on the trigger modes, see "Trigger modes" in section 5.2, "Triggering Section." 1.25 M points or less: 100 ms/division to 500 s/division 6.25 M points: 500 ms/division to 500 s/division 12.5 M points: 500 ms/division to 500 s/division 25 M points: 1 s/division to 500 s/division 62.5 M points: 5 s/division to 500 s/division 125 M points: 5 s/division to 500 s/division 250 M points: 10 s/division to 500 s/division

1 CH1 and CH2 on the DLM2022, DLM2032, and DLM2052.

2 Logic only available on the DLM2024, DLM2034, and DLM2054.

Signal Acquisition and Screen Display

Item	Specifications
Acquisition modes	Normal, Envelope, and Averaging. Normal: Normal sampling without special processing. Envelope: From the data sampled at the maximum real-time sample rate, the DLM2000 acquires the maximum and minimum values for each memory acquisition interval. Average: Averages normally sampled data over multiple acquisitions. Exponential averaging is performed when the trigger mode is set to Auto, Auto Level, or Normal, and linear averaging is performed when the trigger mode is set to Single. The trigger mode is set to Normal for N Single. The attenuation constant for exponential averaging and the linear average count can be set to a value from 2 to 1024 in 2 ⁿ steps. Averaging cannot be used on logic waveforms. For details on the trigger modes, see "Trigger modes" in section 5.2, "Triggering Section."
Sampling modes	You can select real-time, repetitive, or interpolation sampling mode. When you use a short time scale that would cause the sample rate to exceed the real-time sampling maximum sample rate with the specified record length kept constant, the DLM2000 operates as follows: For the maximum sample rates, see "Maximum sample rate" in section 5.1, "Signal Input Section." Realtime: Achieves the desired time scale by reducing the display record length. Interpolation: Performs interpolation sampling. If you decrease the time scale further and the upper limit of the interpolation sampling rate is exceeded, the DLM2000 reduces the display record length to achieve the desired time scale. Repetitive: Performs repetitive sampling. If you decrease the time scale further and the upper limit of the repetitive sampling rate is exceeded, the DLM2000 reduces the display record length to achieve the desired time scale.
High resolution mode	Improves the analog waveform S/N ratio by combining the high resolution mode and the digital filter. Improves the vertical resolution up to 12 bits.

Item	Specifications
Record lengths	<p>Standard model: 1.25 k points, 12.5 k points, 125 k points, 1.25 M points, 6.25 M points (single only), 12.5 M points (interleave and single only)</p> <p>/M1(S) option: 1.25 k points, 12.5 k points, 125 k points, 1.25 M points, 6.25 M points, 25 M points (single only), 62.5 M points (interleave and single only)</p> <p>/M2 option: 1.25 k points, 12.5 k points, 125 k points, 1.25 M points, 12.5 M points, 62.5 M points (single only), 125 M points (interleave and single only)</p> <p>/M3 option: 1.25 k points, 12.5 k points, 125 k points, 1.25 M points, 25 M points, 125 M points (single only), 250 M points (interleave and single only)</p>
History feature	<p>Automatically saves history waveforms (past waveforms that have been acquired using the same acquisition conditions).</p> <p>Cannot be used in average mode, repetitive mode, or roll mode. Cannot be used at record lengths that only allow Single trigger mode.</p> <p>The maximum number of acquisitions that can be held is as follows:</p> <p>Standard model: Up to 2500 acquisitions (when the record length is set to 1.25 k points)</p> <p>/M1(S) option: Up to 10000 acquisitions (when the record length is set to 1.25 k points)</p> <p>/M2 option: Up to 20000 acquisitions (when the record length is set to 1.25 k points)</p> <p>/M3 option: Up to 50000 acquisitions (when the record length is set to 1.25 k points)</p>
Accumulation	Waveforms can be accumulated. Count mode and time mode are selectable. Accumulated waveforms can be saved and loaded.
Zoom	<p>Expands waveforms vertically (analog waveforms only) and horizontally (along the time axis). Two locations, Zoom1 and Zoom2, can be expanded. Separate magnification settings can be specified for each location.</p> <p>Auto scrolling and searching are available as supplementary features of the zoom feature. For details on searching, see "Waveform Searching" described later.</p> <p>Vertical zoom</p> <p>Zoom source waveform: CH1 to CH4*, MATH1, MATH2*</p> <p>Zoom position: The center position to zoom in on on the zoom source waveform can be specified. Selectable range: ± 4 divisions</p> <p>Zoom factor: The selectable range is 1 to 10.</p> <p>Time axis zoom</p> <p>Zoom position: The center position to zoom in on on the main waveform can be specified. Selectable range: ± 5 divisions</p> <p>Zoom factor: Can be set using the time scale magnification knob. Press the knob to switch between Coarse and Fine. With the Coarse setting, values are set in 1-2-5 steps. With the Fine setting, values are set in more detail. The selectable range is from 2 or 2.5 to the magnification that corresponds to 2.5 points/10 divisions or 3.125 points/10 divisions. If the record length or time axis is changed, the DLM2000 retains the zoom factor as much as possible.</p> <p>Auto scroll feature: Automatically moves the zoom position in the specified direction.</p>
Display format	<p>The display can be divided into 1, 2, 3, 4, or 6 areas (1, 2, or 3 areas on the DLM2022, DLM2032, and DLM2052).</p> <p>The display format can also be set to Auto, a setting that causes the DLM2000 to automatically select the number of areas depending on the number of displayed waveforms.</p> <p>The zoom windows can be divided into 1, 2, 3, 4, or 6 areas (1, 2, or 3 areas on the DLM2022, DLM2032, and DLM2052) or can be set to follow the main window setting. When a zoom window and the main window are displayed at the same time, you can set the vertical display area of the main window to 20% or 50%.</p>
Display interpolation	Sampled points can be displayed by using the dot display, sine interpolation display, linear interpolation display, or pulse interpolation display.
Graticule	<p>The graticule can be set to one of the following four grid types: dot grid, line grid, frame, and crosshair. Fine grid can be turned on and off.</p> <p>The normal grid appears in front of the waveforms, and the fine grid appears in the back of the waveforms.</p>
Auxiliary display on and off	Scale values and waveform labels can be turned on and off.
LCD backlight adjustment	<p>The LCD backlight can be turned off manually or automatically (automatically turns off when a specified time elapses with no key activity), and the brightness can be adjusted.</p> <p>If the backlight is off, pressing any key turns on the backlight.</p> <p>The brightness level can be adjusted in the range of 1 to 8 (eight levels).</p>
X-Y display	<p>Two X-Y waveforms, XY1 and XY2, can be displayed (only XY1 on the DLM2022, DLM2032, and DLM2052).</p> <p>X-Y waveforms are displayed in their dedicated window and can be displayed simultaneously with T-Y waveforms.</p> <p>Specify the X-Trace, Y-Trace, and the X-Y display time range.</p> <p>X-Trace: CH1 to CH4*, MATH1, MATH2*</p> <p>Y-Trace: CH1 to CH4*, MATH1, MATH2*</p> <p>Time range: -5 divisions to $+5$ divisions on the main screen</p>

5.5 Features

Item	Specifications
Accumulation	Accumulates waveforms with gradually decreasing intensity for the specified amount of time. The accumulation time can be set to a value from 100 ms to 100 s or to infinite. Intensity and color modes can be selected. Intensity: Accumulates waveforms using separate channel colors with gradually decreasing intensity. Color: Displays the intensity that appears in intensity mode using different colors.
Snapshot	The currently displayed waveforms can be retained on the screen as snapshot waveforms. Snapshot waveforms can be saved and loaded.
Clear trace	Displayed waveforms can be cleared.

* CH1, CH2, and Math1 on the DLM2022, DLM2032, and DLM2052.

Computation, Analysis, and Searching

Item	Specifications
Computation	Two computations can be performed, using MATH1 and MATH2 (only MATH1 on the DLM2022, DLM2032, and DLM2052). Available source channels are as follows: MATH1: CH1 to CH4 ¹ MATH2: CH1 to CH4, and MATH1 The maximum computable record length is as follows: Standard model: 6.25 M points /M1(S) option: 25 M points /M2 option: 62.5 M points /M3 option: 125 M points The following computation types are available. Standard model: Operators +, -, *, FILTER, INTEG, COUNT (EDGE/ROTARY) User-defined computation (option): Expressions can be created by combining the following operators and constants. Operators +, -, *, /, ABS, SQRT, LOG, LN, EXP, P2, SIN, ASIN, COS, ACOS, TAN, ATAN, PH, DIFF, INTEG, FILT1, FILT2, HLBT, MEAN, DELAY, BIN, PWHH, PWHL, PWLH, PWLL, PWXX, FV, DUTYH, DUTYL, DA Constants K1 to K4, 0 to 9, PI, e, fs, 1/fs, Exp, Measure
FFT	Two FFT (Fast Fourier Transform) waveforms, FFT1 and FFT2, can be displayed (only FFT1 on the DLM2022, DLM2032, and DLM2052). Sources: CH1 to CH4 ² , MATH1, MATH2 ² Ranges: Main, Zoom1, Zoom2 FFT Points: 1.25 k, 12.5 k, 125 k, 250 k points (samples the waveform in the above range using the specified number of FFT points) Windows: Rectangular, Hanning, and flattop Modes: Normal, Max Hold, Average On models with the user-defined computation option, the FFT's Type and Sub type settings can be set as follows: Type: LS, RS, PS, PSD, CS, TF, CH Sub type: MAG, LOGMAG, PHASE, REAL, IMAG
Reference waveforms	Two reference waveforms, REF1 and REF2, can be displayed (only REF1 on the DLM2022, DLM2032, and DLM2052). Saved waveforms and channel waveforms can be loaded into REF1 and REF2. REF1 uses the MATH1 waveform. REF2 uses the MATH2 waveform. Therefore, REF and MATH cannot be used simultaneously. Maximum record length at which reference waveforms can be used is the same as the maximum record length at which computation is possible.
Serial bus signal analysis ³	FlexRay, CAN, CAN FD (ISO 11898-1: 2015 or non-ISO), LIN, CXPI, SENT, PSI5 Airbag, UART, I2C, SPI, and user-defined serial bus data can be analyzed and displayed. The DLM2000 can decode frames, fields, and other information from the waveform displayed on the screen. Then, it can display the decoded results and the waveform together on the screen or display a list of detailed decoded results. For SENT and PSI5 Airbag signals, trend display is also possible. By setting search conditions and performing a search, you can display an expanded waveform with the detected frame's or field's first data byte at the center of the window. The DLM2000 can analyze and search the waveforms of up to four serial bus signals. The DLM2022, DLM2032, and DLM2052 can analyze and search the waveforms of one serial bus signal (Serial Bus1).

Item	Specifications
History waveform searching	<p>You can search for waveforms that meet specified conditions, display detected history waveforms, and list the timestamps of the waveforms.</p> <p>You can set a search condition to search for history waveforms that enter a rectangular zone (Simple) or set four⁴ conditions⁴ and search on the AND or OR logic of these conditions.</p> <p>Search criterion can be set to whether the source waveform enters the search range (IN), moves outside the search range (OUT), or don't care (X).</p> <p>The following four search range types are available.</p> <p>Rect-Zone: Rectangular zone. FFT waveforms cannot be used.</p> <p>Wave-Zone: Waveform zone. XY and FFT waveforms cannot be used.</p> <p>Polygon-Zone: Polygonal zone. FFT waveforms cannot be used.</p> <p>Parameter: Zone between the upper and lower limits of one waveform parameter.</p>
Waveform searching	<p>Searches the displayed waveform for locations that meet the specified conditions and displays the waveform expanded around the detected points.</p> <p>Up to 50000 points can be detected within the specified search range.</p> <p>Search feature: Searches for a particular section after a particular time (Start Point) on the currently displayed waveform and displays the section in the zoom window. Selectable Start Point range is ± 5 divisions.</p> <p>Search Types: Edge, Edge Qualified, State, Pulse Width, State Width</p>
Cursor measurement	<p>The following cursors are selectable.</p> <p>ΔT, ΔV, ΔT & ΔV, Marker, Degree</p>
Automated measurement of waveform parameters	<p>The following waveform parameters can be automatically measured.</p> <ul style="list-style-type: none"> Items that are measured over the entire specified range of data and are irrelevant to the period. Max, Min, P-P, High, Low, Amplitude, Rms, Mean, Sdev, IntegTY+, IntegTY, +Over, -Over, Pulse Count, Edge Count Items that are measured in the first period in the specified range. Freq, Period, Burst, +Width, -Width, Duty, Rise, Fall, Delay Items that are measured over all periods in the specified range. AvgFreq, AvgPeriod ΔT & ΔV cursor value V1, V2, ΔT <p>For logic signal, the following items are selectable.</p> <p>Freq, Period, AveFreq, Duty, Pulse Count, Delay</p> <p>In cycle mode, the following items are valid.</p> <p>Max, Min, P-P, High, Low, Amplitude, Rms, Mean, Sdev, IntegTY+, IntegTY, +Over, -Over</p> <p>The maximum total number of items that can be displayed in Area1 and Area2 on the screen is 30.</p>
Statistical processing of waveform parameters	<p>The following three types of statistical processing are available.</p> <p>Continuous: Calculates statistics on normal measurement that is performed multiple times.</p> <p>Cycle: Calculates statistics on the measurement of each period of the displayed waveform.</p> <p>History: Calculates statistics on the measurements of multiple history waveforms.</p> <p>The calculated statistics are as follows:</p> <p>Statistical items: Max, Min, Mean, σ, Count</p>
Trend display and histogram display of waveform parameters	<p>Up to two trends or histograms of the specified measurement items can be displayed (only one on the DLM2022, DLM2032, DLM2052).</p> <p>The maximum number of items that can be displayed on the screen is nine.</p>
Expanded parameter measurement	<p>Automated measurement of waveform parameters can be performed on two areas. Calculations can be performed using the automated measurement values of waveform parameters.</p> <p>In addition to the normal waveform measurement range (Area1), you can specify another measurement range (Area2).</p> <p>The same parameter measurement as Area1 can be performed in Area2. Cycle mode can be set on Area2.</p> <p>The items that can be measured in Cycle mode are as follows:</p> <p>Max, Min, P-P, High, Low, Rms, Mean, Sdev, IntegTY+, IntegTY, +Over, -Over</p> <p>The maximum total number of items that can be displayed in Area1 and Area2 on the screen is 30.</p>
Frequency distribution analysis	<p>Counts the frequency of data occurrence in a specified area and displays the values in a histogram.</p> <p>You can select whether to count the voltage data frequency or the time data frequency.</p> <p>The mean, standard deviation, maximum value, minimum value, peak value, median, etc., can be measured on the histogram.</p> <p>You can set up to two histogram source waveforms (Hist1 and Hist2; only HIST1 on the DLM2022, DLM2032, and DLM2052).</p>
Action-on-trigger	<p>A specific action can be executed when the DLM2000 triggers.</p> <p>You can set the number of times to execute the action in terms of the number of waveform acquisitions or the number of determinations.</p> <p>Actions: Beeping, screen capture data printing or saving, waveform data saving, mail transmission⁵</p>

5.5 Features

Item	Specifications
GO/NO-GO determination	<p>A specific action can be executed when the GO/NO-GO result is NO-GO. You can set the number of times to execute the action in terms of the number of waveform acquisitions or the number of determinations. Up to four conditions can be set, and the four⁴ conditions can be combined using AND or OR logic to perform determination. Reference condition can be set to whether the source waveform enters the reference range (IN), moves outside the search range (OUT), or don't care (X).</p> <p>The following four reference range types are available.</p> <p>Rect-Zone: Rectangular zone. FFT waveforms cannot be used.</p> <p>Wave-Zone: Waveform zone. XY and FFT waveforms cannot be used.</p> <p>Polygon-Zone: Polygonal zone. FFT waveforms cannot be used.</p> <p>Parameter: Zone between the upper and lower limits of one waveform parameter.</p> <p>Actions</p> <p>Beeping, screen capture data printing or saving, waveform data saving, mail transmission⁵</p>
Power supply analysis feature (option)	<p>You can select and execute the analysis feature or power measurement feature.</p> <p>Analysis feature: Two of the following analyses can be executed simultaneously.</p> <ul style="list-style-type: none"> Switching loss analysis (SW Loss): The total loss and the switching loss can be measured. Items such as power waveforms and measured values can be displayed, and statistics can be computed. The items whose switching losses can be measured automatically are listed below. Wp, Wp+, Wp-, Abs.Wp, P, P+, P-, Abs.P, Z Safe Operating Area (SOA): An X-Y display can be created with voltage input plotted on the X-axis and current input plotted on the Y-axis. Harmonic analysis (Harmonics): Simple comparisons can be made between the harmonics and standard limits. IEC 61000-3-2 Ed. 2.2, "Electromagnetic compatibility (EMC) - Part 3-2: Limits - Limits for harmonic current emissions (equipment input current ≤ 16 A per phase)" EN 61000-3-2 (2000) IEC 61000-4-7 Ed. 2 Joule integral (I²t): Items such as Joule integral waveforms and measured values can be displayed, and statistics can be computed. The item whose Joule integral can be measured automatically is shown below. I²t <p>Power measurement feature: The power of up to two circuits can be measured simultaneously. The items that can be measured automatically are shown below. U+pk, U-pk, Up-p, Udc, Uac, Urms, Umn, Urmn, Avg Freq (of voltage), I+pk, I-pk, Ip-p, Idc, Iac, Irms, Imn, Irmn, Avg Freq (of current), S, P, Q, Z, λ, Wp, Wp+, Wp-, Abs.Wp, q, q+, q-, Abs.q</p> <p>The auto deskew feature automatically deskews the time difference between the voltage and current waveforms. Auto deskew uses voltage and current signals of the deskew signal sources (701935 or 701936; sold separately) that are received through probes connected to voltage channels and current channels, respectively. For information about the deskew range, see "Deskewing" described earlier.</p>

1 CH1 and CH2 on the DLM2022, DLM2032, and DLM2052.

2 CH1, CH2, and MATH1 on the DLM2022, DLM2032, and DLM2052.

3 FlexRay, CAN, CAN FD, LIN, CXPI, SENT, PSI5, UART, I2C, and SPI are options for 4-channel models.

4 Two on the DLM2022, DLM2032, and DLM2052.

5 On models with the Ethernet option.

Screen Capture Data Printing and Saving

Item	Specifications
Built-in printer (option)	<p>Prints screen captures in one of the following output formats.</p> <p>HardCopy: Prints the displayed screen image.</p> <p>Normal: Prints only the waveform area of the displayed screen image. The menu is not printed. If cursor measurements or automatically measured results are displayed, they are printed below the waveform area.</p> <p>Long: Prints a screen capture whose time axis is magnified 2 to 10 times. The menu is not printed. If cursor measurements or automatically measured results are displayed, they are printed below the waveform area.</p>
USB printer	<p>Prints screen captures on an external printer via USB. Color can be turned on or off. Supports Epson inkjet printers and HP inkjet printers.</p>
Network printer	<p>Prints screen captures on an external printer via Ethernet.* Color can be turned on or off. Supports Epson inkjet printers, HP inkjet printers, and HP laser printers.</p>
File	<p>Saves screen capture data to the specified storage medium using one of the following save modes. The storage medium can be set to internal memory or USB storage. Output data format can be set to PNG or JPEG. Available color settings are OFF, ON, ON (Rev), and ON (Gray).</p> <p>HardCopy: Saves the displayed screen image.</p> <p>Normal: Saves only the waveform area of the displayed screen image. The menu is not saved. If cursor measurements or automatically measured results are displayed, they are saved below the waveform area.</p> <p>Wide: Saves a screen capture whose time axis is magnified twice. The menu is not saved. If cursor measurements or automatically measured results are displayed, they are saved below the waveform area.</p>

* On models with the Ethernet option.

Data Storage

Item	Specifications
Waveform data	<p>Saves waveform data (including history waveforms) to the specified storage medium.¹ The saved data can be loaded into the DLM2000. Available data formats are binary (.wdf) and ASCII (.csv). Only binary (.wdf) files can be loaded into the DLM2000. Waveform data is saved by specifying the data format, the waveform to save, the history range, the window to be saved (Main, Zoom1, or Zoom2), and the compression method (OFF, P-P, or Decimation). Waveform data is loaded by setting the load destination to ACQ memory, REF1 (MATH1), or REF2 (MATH2).² If waveform data is loaded into the ACQ memory, the data is cleared when you start waveform acquisition.</p>
Setup data	<p>Setup data can be saved to the specified storage medium.¹ The saved data can be loaded into the DLM2000.</p>
Setup data (storage and recall)	<p>Up to three sets of setup data can be stored and loaded from the internal memory.</p>
Other types of data	<p>The displayed screen image can be saved. Waveform zones can be saved and loaded. Polygonal zones can be loaded. Snapshot waveforms can be saved and loaded. Automatically measured waveform parameters can be saved. Serial bus analysis results can be saved. FFT waveform data can be saved. Histogram data can be saved and loaded.</p>

¹ The storage medium can be set to internal memory or USB storage.

² ACQ memory or REF1 (MATH1) on the DLM2022, DLM2032, and DLM2052.

5.5 Features

Other Features

Item	Specifications
Default setup	Resets the DLM2000 to its factory default settings. The following settings are not reset: date and time settings, communication interface settings, settings stored to the internal memory, and language settings. The Undo command can be used to revert to the previous settings.
Auto setup	Automatically sets the voltage scale, time scale, trigger, and other settings to the most suitable values for the input signals. The Undo command can be used to revert to the previous settings.
Serial bus auto setup*	Auto setup can be executed on the basis of the selected serial bus type (FlexRay, CAN, CAN FD, LIN, CXPI, SENT, PSI5 Airbag, UART, I ² C, or SPI) and trigger source. The DLM2000 can automatically set the bit rate, source level, and other settings and trigger on the basis of these settings.
Calibration	Auto calibration and manual calibration are available.
Environment settings	The date, time, and message language can be specified. The click sound can be turned on and off.
Probe compensation signal output	Transmits signals from the front-panel probe compensation signal output terminals (approx. 1-V _{p-p} and approx. 1-kHz rectangular wave).
Overview	Allows you to view the DLM2000 system status.
Additional option license	Trigger, computation, and analysis options can be added (only on 4-channel models).
Self-tests	Memory, accuracy, and printer tests are available.
Menu language setting	The menu language can be switched.
Help feature	Displays a description of the settings.

* On models with the serial bus option.

5.6 Built-in Printer (/B5 Option)

Item	Specifications
Print system	Thermal line dot system
Dot density	8 dots/mm
Sheet width	112 mm

5.7 Storage

Internal Memory

Item	Specifications
Media type	SD memory card
Memory size	Standard model: Approx. 300 MB /C8 option: Approx. 1.8 GB /C9 option: Approx. 7.2 GB

USB Storage Device

Item	Specifications
Compatible USB storage devices	Mass storage device compatible with USB Mass Storage Class Ver. 1.1
Available space	2 TB Partition format: MBR, format type: FAT32/FAT16

* See section 5.8, "USB for Peripherals."

5.8 USB for Peripherals

Item	Specifications
Connector type	USB type A (receptacle)
Electrical and mechanical specifications	USB Rev. 2.0 compliant
Supported transfer modes	LS (Low Speed; 1.5 Mbps), FS (Full Speed; 12 Mbps), HS (High Speed; 480 Mbps)
Ports	2
Power supply	5 V, 500 mA (for each port)
Compatible devices	Mouse devices that comply with USB HID Class Ver. 1.1 104 or 109 (Japanese) keyboards that comply with USB HID Class Ver. 1.1 Supports Epson inkjet printers and HP inkjet printers that are compatible with USB Printer Class Ver. 1.0. Mass storage device compatible with USB Mass Storage Class Ver. 1.1. USB HUB device
No. of connectable devices	Hub: 1 per port Mouse, keyboard, and printer: 1 each Mass storage devices: 4 Up to six devices can be connected including the hub

5.9 Auxiliary I/O Section

External Trigger Input (TRIG IN)

Item	Specifications
Connector type	BNC
Input bandwidth*	DC to 100 MHz
Input impedance	Approx. 1 M Ω , approx. 20 pF
Maximum input voltage	± 40 V (DC + ACpeak) or 28 Vrms (At 1 MHz and higher, the voltage decreases at 20 dB/decade down to ± 5 V (DC+ACpeak) or 3.5 Vrms.)
Input range	± 2 V (DLM2024, DLM2034, DLM2054). ± 1 V (for the ± 1 V range on the DLM2022, DLM2032, DLM2052). ± 10 V (for the ± 10 V range on the DLM2022, DLM2032, DLM2052).
Trigger level	± 2 V. The resolution is 5 mV (DLM2024, DLM2034, DLM2054). ± 1 V. The resolution is 5 mV (for the ± 1 V range on the DLM2022, DLM2032, DLM2052). ± 10 V. The resolution is 50 mV (for the ± 10 V range on the DLM2022, DLM2032, DLM2052).

* Values measured under standard operating conditions (see section 5.11 for details) after a 30-minute warm-up.

Trigger Output (TRIG OUT)

Item	Specifications
Connector type	BNC
Output level	3.3 V CMOS
Output impedance	Approx. 50 Ω
Output logic	Negative logic and positive logic switchable
Output delay	50 ns max.
Output hold time	Negative logic: Low level: 800 ns min. High level: 50 ns min. Positive logic: High level: 800 ns min. Low level: 50 ns min.

Probe Interface Terminal

Item	Specifications
Output terminals	DLM2022, DLM2032, DLM2052: 3 DLM2024, DLM2034, DLM2054: 4
Output voltage	± 12 V (up to 1.2 A in combination with the rear-panel probe power terminal), ± 5 V (up to 800 mA total)
Usable probes	Active probes (701912, 701913, 701914), differential probes (701923, 701924, 701927), current probes (701928, 701929)

Probe Power Terminal (/P2 and /P4 Option)

Item	Specifications
Output terminals	DLM2022, DLM2032, DLM2052: 2 (/P2 option) DLM2024, DLM2034, DLM2054: 4 (/P4 option)
Output voltage	± 12 V (up to 1.2 A in combination with the probe interface terminal)
Usable probes and deskew signal sources	FET probe (700939), current probe (701930, 701931, 701932, 701933), differential probes (700924, 700925, 701920, 701921, 701922, 701926), deskew signal source (701936)

GO/NO-GO Output

Item	Specifications
Connector type	RJ-12 modular jack
Output signal	GO OUT, NO-GO OUT
Output level	TTL compatible
Compliant cable	Four-wire modular cable

Video Signal Output (VIDEO OUT)

Item	Specifications
Connector type	D-sub 15 pin (receptacle)
Output type	Analog RGB output
Output resolution	XGA-compliant output, 1024 \times 768 dots, approx. 60-Hz Vsync (66-MHz dot clock frequency)

5.10 Computer Interface

GP-IB (Option)

Item	Specifications
Electrical and mechanical specifications	Complies with IEEE St'd 488-1978 (JIS C 1901-1987)
Functional specifications	SH1, AH1, T6, L4, SR1, RL1, PP0, DC1, DT0, C0
Protocol	Complies with IEEE St'd 488.2-1992
Code	ISO (ASCII)
Mode	Addressable mode
Addresses	Talker and listener addresses can be specified from 0 to 30.
Clearing remote mode	Remote mode can be cleared with the SHIFT+CLEAR TRACE key (except during Local Lockout).

USB for PC Connection

Item	Specifications
Connector type	USB type B (receptacle)
Electrical and mechanical specifications	USB Rev. 2.0 compliant
Supported transfer modes	FS (Full Speed; 12 Mbps), HS (High Speed; 480 Mbps)
Ports	1
Supported protocols	Functions as a device that conforms to one of the following two protocols. USBTMC-USB488 (USB Test and Measurement Class Ver. 1.0)* GP-IB commands can be used through USB. Mass Storage Class Ver.1.1 Only reading is possible from the DLM2000 internal memory through PC access. (Operations, such as formatting, are not possible.)
PC system requirements	A PC running the English or Japanese version of Windows 7 (32bit, 64bit), Windows 8 (32bit, 64bit), Windows 8.1 (32bit, 64bit), or Windows 10 (32bit, 64bit)

* A separate driver is required.

Ethernet Interface (/C10 and /C11 options)

Item	Specifications
Connector type	RJ-45
Ports	1
Electrical and mechanical specifications	IEEE 802.3 compliant
Transmission system	Ethernet (1000BASE-T, 100BASE-TX, 10BASE-T)
Communication protocol	TCP/IP
Supported services	Server: FTP, HTTP(Web), VXI-11 Client: FTP (Net Drive), SMTP (Mail), SNMP, LPR (Net Print), DHCP, DNS
PC system requirements	A PC running the English or Japanese version of Windows 7 (32bit, 64bit), Windows 8 (32bit, 64bit), Windows 8.1 (32bit, 64bit), or Windows 10 (32bit, 64bit)

5.11 General Specifications

Item	Specifications
Standard operating conditions	Ambient temperature: 23 ± 5°C Ambient humidity: 55 ± 10%RH Supply voltage and frequency errors: Within 1% of rating
Warm-up time	At least 30 minutes
Storage environment	Temperature: -20 to 60°C Humidity: 20 to 80%RH (no condensation) Altitude: 3000 m or less
Operating environment	Temperature: 5 to 40°C Humidity: 20 to 80%RH (when the printer is not used; no condensation) 35 to 80%RH (when the printer is used; no condensation) Altitude: 2000 m or less
Recommended calibration period	One year
Rated supply voltage	100 to 240 VAC
Permitted supply voltage range	90 to 264 VAC
Rated supply frequency	50/60 Hz
Permitted supply voltage frequency range	48 to 63 Hz
Power fuse	Built in (not replaceable)
Maximum power consumption	170 VA (when the printer is used)
Withstand voltage (between the power supply and case)	1.5 kVAC for 1 minute
Insulation resistance (between the power supply and case)	500 VDC, 10 MΩ or more
External dimensions	226 mm (W) × 293 mm (H) × 193 mm (D) when the printer cover is closed; excluding protrusions
Weight	Approx. 4.2 kg (excluding options)
Instrument cooling method	Forced air cooling; inlet on the left side, outlet on the rear
Installation position	Horizontal
Battery backup	The clock is backed up with the internal lithium battery. Battery life: Approx. five years (at an ambient temperature of 25°C)

Item	Specifications
Safety standard	<p>Compliant standard</p> <p>EN 61010-1</p> <p>Overvoltage Category II¹</p> <p>Pollution degree 2²</p> <p>EN 61010-2-030</p> <p>Measurement Category Other (O)³</p>
Emissions	<p>Compliant standard</p> <p>EN 61326-1 Class A</p> <p>EN 61326-2-1</p> <p>EN 55011 Class A, Group 1</p> <p>EMC Regulatory Arrangement in Australia and New Zealand EN 55011 Class A, Group 1</p> <p>Korea Electromagnetic Conformity Standard (한국 전자파적합성기준)</p> <p>(Applicable to the 710105, 710110, 710115, 710120, 710125, 710130, 701938, 701939, 701913, 701924, 701928, 701929, 701988, 701989)</p> <p>EN 61000-3-2</p> <p>EN 61000-3-3</p> <p>This is a class A instrument designed for an industrial environment. Operation of this equipment in a residential area may cause radio interference, in which case users will be required to correct the interference.</p> <p>Cable conditions</p> <p>Logic signal input port</p> <p>Attach ferrite cores (TDK: ZCAT2035-0930A, YOKOGAWA: A1190MN) to the both end of logic probe cables.</p> <p>Probe power terminal</p> <p>Attach ferrite cores (TDK: ZCAT1325-0530A, YOKOGAWA: A1181MN) to the DLM2000 end of B9852MJ dedicated power cables, which is sold separately.</p> <p>Ethernet interface connector</p> <p>Use Ethernet cables that are 30 m or less in length.</p> <p>External trigger input (TRIG IN) terminal</p> <p>Use a BNC cable that is 3 m or less in length.</p> <p>Trigger output (TRIG OUT) terminal</p> <p>Use a BNC cable that is 3 m or less in length.</p> <p>Video signal output (VIDEO OUT) terminal</p> <p>Use a shielded D-Sub 15-pin VGA cable that is 3 m or less in length.</p> <p>USB port for peripherals</p> <p>Attach a ferrite core (TDK: ZCAT2035-0930A, YOKOGAWA: A1190MN) to the DLM2000 end of a USB cable by passing the cable twice through the core (see the figure below). Use cables that are 3 m or less in length.</p> <p>USB port for PCs</p> <p>Attach a ferrite core (TDK: ZCAT2035-0930A, YOKOGAWA: A1190MN) to the DLM2000 end of a USB cable by passing the cable twice through the core (see the figure below). Use cables that are 3 m or less in length.</p> <p>GO/NO-GO output terminal</p> <p>Use the dedicated GO/NO-GO cable (YOKOGAWA: 366973) that is sold separately. Attach a ferrite-core (TDK: ZCAT2035-0930A, YOKOGAWA: A1190MN) to the DLM2000 end of a cable by passing the cable twice through the core (see the figure below).</p>

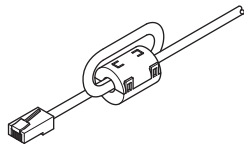

- 1 The overvoltage category (installation category) is a value used to define the transient overvoltage condition and includes the rated impulse withstand voltage. The overvoltage category II applies to electrical equipment that is powered through a fixed installation, such as a switchboard.
- 2 The pollution degree refers to the degree of adhesion of a solid, liquid, or gas which deteriorates withstand voltage or surface resistivity. Pollution degree 2 applies to normal indoor atmospheres (with only non-conductive pollution).
- 3 The measurement category of the DLM2000 signal input terminals is Other (O). Do not use it to measure the main power supply or for Measurement Categories II, III, and IV.

Measurement category Other (O) applies to measurement of circuits that are not directly connected to a main power supply. This category applies to measurement of secondary electric circuits in equipment across a transformer. The estimated transient overvoltage that may be applied to the DLM2000 signal input terminals is 1500 V.

Measurement category II applies to measurement of circuits, such as household electric appliances and portable electric tools, that are connected to low-voltage installations.

Measurement category III applies to measurement of facility circuits, such as distribution boards and circuit breakers.

Measurement category IV applies to measurement of power source circuits, such as entrance cables to buildings and cable systems, for low-voltage installations.

5.11 General Specifications

Item	Specifications
Immunity	<p>Compliant standard</p> <p>EN 61326-1 Table 2 (for use in industrial locations)</p> <p>EN 61326-2-1</p> <p>(Applicable to the 710105, 710110, 710115, 710120, 710125, 710130, 701938, 701939, 701913, 701924, 701928, 701929, 701988, 701989)</p> <hr/> <p>Influence in the immunity testing environment (criteria A)</p> <p>Noise increase: Within ± 200 mV (when using the 701938 or 701939)</p> <p>Within ± 2 V (when using the 701913 or 701924)</p> <p>Within ± 1 A (when using the 701928 or 701929)</p> <p>Logic signal polarity inversion does not occur (when using the 701988 or 701989)</p> <p>Test conditions: When using the 701913</p> <p>1.25 GS/s, envelope mode, 20MHz BWL, probe attenuation set to 10:1, probe tip terminated at 50 Ω</p> <p>When using the 701914</p> <p>1.25 GS/s, envelope mode, 20MHz BWL, probe attenuation set to 50:1, probe tip terminated at 50 Ω</p> <p>When using the 701928 or 701929</p> <p>1.25 GS/s, envelope mode, 20MHz BWL, probe attenuation set to 10A:1V, probe tip terminated at 50 Ω</p> <p>When using the 701988 or 701989</p> <p>1.25 GS/s, envelope mode, 20MHz BWL, probe tip terminated at 50 Ω</p> <p>Cable conditions: Same as the emission cable conditions.</p> <p>Test items:</p> <ol style="list-style-type: none"> Static discharge: EN 61000-4-2 Air discharge: ± 8 kV. Contact discharge: ± 4 kV. Criteria B. Radiated immunity: EN 61000-4-3 80 M to 1 GHz, 10 V/m, 1.4 to 2 GHz, 3 V/m, 2.0 to 2.7 GHz, 3 V/m, criteria A Conducted immunity: EN 61000-4-6 3 V, criteria A EFT/Burst: EN 61000-4-4 Power line: ± 2 kV. Signal line: ± 1 kV, criteria B Power frequency magnetic fields: EN 61000-4-8 30 A/m, 50 Hz, criteria A Surge immunity: EN 61000-4-5 ± 1 kV between lines, ± 2 kV common, criteria B Voltage dip and interruptions: EN 61000-4-11 1 cycle, both polarities, 100%, criteria B Other tests, criteria C <p>Definitions of criteria A, B, and C</p> <p>Criteria A: During testing, "influence in the immunity testing environment" described above is met.</p> <p>Criteria B: The instrument continues to function and is controllable throughout testing. The instrument does not change operation modes, and data changes do not persist.</p> <p>Criteria C: During testing, temporary degradation of performance or loss of functionality occurred, the correction of which required user operation or system reset.</p> <hr/> <p>Environmental standard</p> <p>Compliant standard</p> <p>EN 50581 Monitoring and control instruments including industrial monitoring and control instruments.</p>

5.12 External Dimensions

Unit: mm

Unless otherwise specified, tolerances are $\pm 3\%$ (however, tolerances are ± 0.3 mm when below 10 mm).

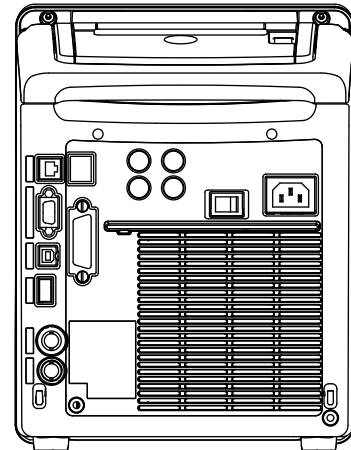
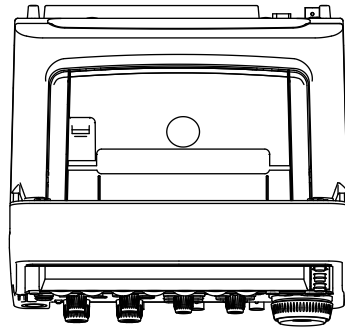

Rear view

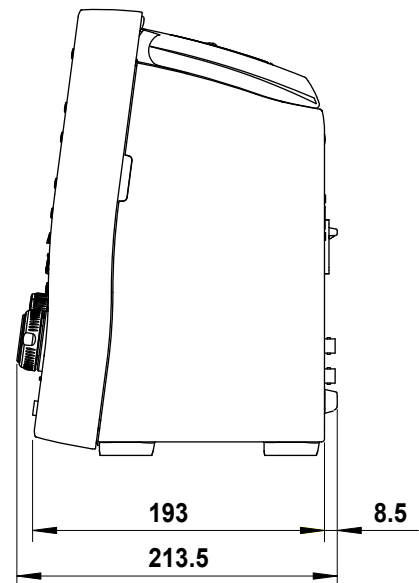
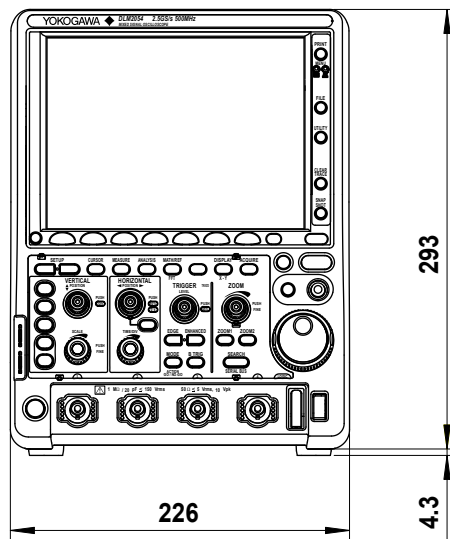

Appendix 1 Relationship between the Time Axis Setting, Record Length, and Sample Rate

When the Record Length Is 1.25 k points

(This record length can be selected on all models)

Intpl: Interpolation Mode

Rep: Repetitive Sampling Mode

Settings Time/div	When High Resolution mode is off								When High Resolution mode is on							
	When Interleave mode is off				When Interleave mode is on				When Interleave mode is off				When Interleave mode is on			
	Realtime		Intpl/Rep		Realtime		Intpl/Rep		Realtime		Intpl/Rep		Realtime		Intpl/Rep	
	Sample Rate (S/s)	Record Length (Points)	Sample Rate (S/s)	Record Length (Points)	Sample Rate (S/s)	Record Length (Points)	Sample Rate (S/s)	Record Length (Points)	Sample Rate (S/s)	Record Length (Points)	Sample Rate (S/s)	Record Length (Points)	Sample Rate (S/s)	Record Length (Points)	Sample Rate (S/s)	Record Length (Points)
500 s	50	250 k	50	250 k	50	250 k	50	250 k	50	250 k	50	250 k	50	250 k	50	250 k
200 s	50	100 k	50	100 k	50	100 k	50	100 k	50	100 k	50	100 k	50	100 k	50	100 k
100 s	50	50 k	50	50 k	50	50 k	50	50 k	50	50 k	50	50 k	50	50 k	50	50 k
50 s	50	25 k	50	25 k	50	25 k	50	25 k	50	25 k	50	25 k	50	25 k	50	25 k
20 s	50	10 k	50	10 k	50	10 k	50	10 k	50	10 k	50	10 k	50	10 k	50	10 k
10 s	50	5 k	50	5 k	50	5 k	50	5 k	50	5 k	50	5 k	50	5 k	50	5 k
5 s	50	2.5 k	50	2.5 k	50	2.5 k	50	2.5 k	50	2.5 k	50	2.5 k	50	2.5 k	50	2.5 k
2 s	62.5	1.25 k	62.5	1.25 k	62.5	1.25 k	62.5	1.25 k	62.5	1.25 k	62.5	1.25 k	62.5	1.25 k	62.5	1.25 k
1 s	125	1.25 k	125	1.25 k	125	1.25 k	125	1.25 k	125	1.25 k	125	1.25 k	125	1.25 k	125	1.25 k
500 ms	250	1.25 k	250	1.25 k	250	1.25 k	250	1.25 k	250	1.25 k	250	1.25 k	250	1.25 k	250	1.25 k
200 ms	625	1.25 k	625	1.25 k	625	1.25 k	625	1.25 k	625	1.25 k	625	1.25 k	625	1.25 k	625	1.25 k
100 ms	1.25 k	1.25 k	1.25 k	1.25 k	1.25 k	1.25 k	1.25 k	1.25 k	1.25 k	1.25 k	1.25 k	1.25 k	1.25 k	1.25 k	1.25 k	1.25 k
50 ms	2.5 k	1.25 k	2.5 k	1.25 k	2.5 k	1.25 k	2.5 k	1.25 k	2.5 k	1.25 k	2.5 k	1.25 k	2.5 k	1.25 k	2.5 k	1.25 k
20 ms	6.25 k	1.25 k	6.25 k	1.25 k	6.25 k	1.25 k	6.25 k	1.25 k	6.25 k	1.25 k	6.25 k	1.25 k	6.25 k	1.25 k	6.25 k	1.25 k
10 ms	12.5 k	1.25 k	12.5 k	1.25 k	12.5 k	1.25 k	12.5 k	1.25 k	12.5 k	1.25 k	12.5 k	1.25 k	12.5 k	1.25 k	12.5 k	1.25 k
5 ms	25 k	1.25 k	25 k	1.25 k	25 k	1.25 k	25 k	1.25 k	25 k	1.25 k	25 k	1.25 k	25 k	1.25 k	25 k	1.25 k
2 ms	62.5 k	1.25 k	62.5 k	1.25 k	62.5 k	1.25 k	62.5 k	1.25 k	62.5 k	1.25 k	62.5 k	1.25 k	62.5 k	1.25 k	62.5 k	1.25 k
1 ms	125 k	1.25 k	125 k	1.25 k	125 k	1.25 k	125 k	1.25 k	125 k	1.25 k	125 k	1.25 k	125 k	1.25 k	125 k	1.25 k
500 µs	250 k	1.25 k	250 k	1.25 k	250 k	1.25 k	250 k	1.25 k	250 k	1.25 k	250 k	1.25 k	250 k	1.25 k	250 k	1.25 k
200 µs	625 k	1.25 k	625 k	1.25 k	625 k	1.25 k	625 k	1.25 k	625 k	1.25 k	625 k	1.25 k	625 k	1.25 k	625 k	1.25 k
100 µs	1.25 M	1.25 k	1.25 M	1.25 k	1.25 M	1.25 k	1.25 M	1.25 k	1.25 M	1.25 k	1.25 M	1.25 k	1.25 M	1.25 k	1.25 M	1.25 k
50 µs	2.5 M	1.25 k	2.5 M	1.25 k	2.5 M	1.25 k	2.5 M	1.25 k	2.5 M	1.25 k	2.5 M	1.25 k	2.5 M	1.25 k	2.5 M	1.25 k
20 µs	6.25 M	1.25 k	6.25 M	1.25 k	6.25 M	1.25 k	6.25 M	1.25 k	6.25 M	1.25 k	6.25 M	1.25 k	6.25 M	1.25 k	6.25 M	1.25 k
10 µs	12.5 M	1.25 k	12.5 M	1.25 k	12.5 M	1.25 k	12.5 M	1.25 k	12.5 M	1.25 k	12.5 M	1.25 k	12.5 M	1.25 k	12.5 M	1.25 k
5 µs	25 M	1.25 k	25 M	1.25 k	25 M	1.25 k	25 M	1.25 k	25 M	1.25 k	25 M	1.25 k	25 M	1.25 k	25 M	1.25 k
2 µs	62.5 M	1.25 k	62.5 M	1.25 k	62.5 M	1.25 k	62.5 M	1.25 k	62.5 M	1.25 k	62.5 M	1.25 k	62.5 M	1.25 k	62.5 M	1.25 k
1 µs	125 M	1.25 k	125 M	1.25 k	125 M	1.25 k	125 M	1.25 k	125 M	1.25 k	125 M	1.25 k	125 M	1.25 k	125 M	1.25 k
500 ns	250 M	1.25 k	250 M	1.25 k	250 M	1.25 k	250 M	1.25 k	250 M	1.25 k	250 M	1.25 k	250 M	1.25 k	250 M	1.25 k
200 ns	625 M	1.25 k	625 M	1.25 k	625 M	1.25 k	625 M	1.25 k	625 M	1.25 k	625 M	1.25 k	625 M	1.25 k	625 M	1.25 k
100 ns	1.25 G	1.25 k	1.25 G	1.25 k	1.25 G	1.25 k	1.25 G	1.25 k	625 M	625	1.25 G	1.25 k	1.25 G	1.25 k	1.25 G	1.25 k
50 ns	1.25 G	625	2.5 G	1.25 k	2.5 G	1.25 k	2.5 G	1.25 k	625 M	312.5	2.5 G	1.25 k	1.25 G	625	2.5 G	1.25 k
20 ns	1.25 G	250	6.25 G	1.25 k	2.5 G	500	6.25 G	1.25 k	625 M	125	6.25 G	1.25 k	1.25 G	250	6.25 G	1.25 k
10 ns	1.25 G	125	12.5 G	1.25 k	2.5 G	250	12.5 G	1.25 k	625 M	62.5	12.5 G	1.25 k	1.25 G	125	12.5 G	1.25 k
5 ns	1.25 G	62.5	25 G	1.25 k	2.5 G	125	25 G	1.25 k	625 M	31.25	25 G	1.25 k	1.25 G	62.5	25 G	1.25 k
2 ns	1.25 G	25	62.5 G	1.25 k	2.5 G	50	62.5 G	1.25 k	625 M	12.5	62.5 G	1.25 k	1.25 G	25	62.5 G	1.25 k
1 ns	1.25 G	12.5	125 G	1.25 k	2.5 G	25	125 G	1.25 k	625 M	6.25	125 G	1.25 k	1.25 G	12.5	125 G	1.25 k

Values outside of the thick borders have been calculated in real-time sampling mode.

 : Roll Mode

Appendix 1 Relationship between the Time Axis Setting, Record Length, and Sample Rate

When the Record Length Is 12.5 k points

(This record length can be selected on all models)

Intpl: Interpolation Mode

Rep: Repetitive Sampling Mode

Settings Time/div	When High Resolution mode is off								When High Resolution mode is on							
	When Interleave mode is off				When Interleave mode is on				When Interleave mode is off				When Interleave mode is on			
	Realtime		Intpl/Rep		Realtime		Intpl/Rep		Realtime		Intpl/Rep		Realtime		Intpl/Rep	
	Sample Rate (S/s)	Record Length (Points)	Sample Rate (S/s)	Record Length (Points)	Sample Rate (S/s)	Record Length (Points)	Sample Rate (S/s)	Record Length (Points)	Sample Rate (S/s)	Record Length (Points)	Sample Rate (S/s)	Record Length (Points)	Sample Rate (S/s)	Record Length (Points)	Sample Rate (S/s)	Record Length (Points)
500 s	50	250 k	50	250 k	50	250 k	50	250 k	50	250 k	50	250 k	50	250 k	50	250 k
200 s	50	100 k	50	100 k	50	100 k	50	100 k	50	100 k	50	100 k	50	100 k	50	100 k
100 s	50	50 k	50	50 k	50	50 k	50	50 k	50	50 k	50	50 k	50	50 k	50	50 k
50 s	50	25 k	50	25 k	50	25 k	50	25 k	50	25 k	50	25 k	50	25 k	50	25 k
20 s	62.5	12.5 k	62.5	12.5 k	62.5	12.5 k	62.5	12.5 k	62.5	12.5 k	62.5	12.5 k	62.5	12.5 k	62.5	12.5 k
10 s	125	12.5 k	125	12.5 k	125	12.5 k	125	12.5 k	125	12.5 k	125	12.5 k	125	12.5 k	125	12.5 k
5 s	250	12.5 k	250	12.5 k	250	12.5 k	250	12.5 k	250	12.5 k	250	12.5 k	250	12.5 k	250	12.5 k
2 s	625	12.5 k	625	12.5 k	625	12.5 k	625	12.5 k	625	12.5 k	625	12.5 k	625	12.5 k	625	12.5 k
1 s	1.25 k	12.5 k	1.25 k	12.5 k	1.25 k	12.5 k	1.25 k	12.5 k	1.25 k	12.5 k	1.25 k	12.5 k	1.25 k	12.5 k	1.25 k	12.5 k
500 ms	2.5 k	12.5 k	2.5 k	12.5 k	2.5 k	12.5 k	2.5 k	12.5 k	2.5 k	12.5 k	2.5 k	12.5 k	2.5 k	12.5 k	2.5 k	12.5 k
200 ms	6.25 k	12.5 k	6.25 k	12.5 k	6.25 k	12.5 k	6.25 k	12.5 k	6.25 k	12.5 k	6.25 k	12.5 k	6.25 k	12.5 k	6.25 k	12.5 k
100 ms	12.5 k	12.5 k	12.5 k	12.5 k	12.5 k	12.5 k	12.5 k	12.5 k	12.5 k	12.5 k	12.5 k	12.5 k	12.5 k	12.5 k	12.5 k	12.5 k
50 ms	25 k	12.5 k	25 k	12.5 k	25 k	12.5 k	25 k	12.5 k	25 k	12.5 k	25 k	12.5 k	25 k	12.5 k	25 k	12.5 k
20 ms	62.5 k	12.5 k	62.5 k	12.5 k	62.5 k	12.5 k	62.5 k	12.5 k	62.5 k	12.5 k	62.5 k	12.5 k	62.5 k	12.5 k	62.5 k	12.5 k
10 ms	125 k	12.5 k	125 k	12.5 k	125 k	12.5 k	125 k	12.5 k	125 k	12.5 k	125 k	12.5 k	125 k	12.5 k	125 k	12.5 k
5 ms	250 k	12.5 k	250 k	12.5 k	250 k	12.5 k	250 k	12.5 k	250 k	12.5 k	250 k	12.5 k	250 k	12.5 k	250 k	12.5 k
2 ms	625 k	12.5 k	625 k	12.5 k	625 k	12.5 k	625 k	12.5 k	625 k	12.5 k	625 k	12.5 k	625 k	12.5 k	625 k	12.5 k
1 ms	1.25 M	12.5 k	1.25 M	12.5 k	1.25 M	12.5 k	1.25 M	12.5 k	1.25 M	12.5 k	1.25 M	12.5 k	1.25 M	12.5 k	1.25 M	12.5 k
500 µs	2.5 M	12.5 k	2.5 M	12.5 k	2.5 M	12.5 k	2.5 M	12.5 k	2.5 M	12.5 k	2.5 M	12.5 k	2.5 M	12.5 k	2.5 M	12.5 k
200 µs	6.25 M	12.5 k	6.25 M	12.5 k	6.25 M	12.5 k	6.25 M	12.5 k	6.25 M	12.5 k	6.25 M	12.5 k	6.25 M	12.5 k	6.25 M	12.5 k
100 µs	12.5 M	12.5 k	12.5 M	12.5 k	12.5 M	12.5 k	12.5 M	12.5 k	12.5 M	12.5 k	12.5 M	12.5 k	12.5 M	12.5 k	12.5 M	12.5 k
50 µs	25 M	12.5 k	25 M	12.5 k	25 M	12.5 k	25 M	12.5 k	25 M	12.5 k	25 M	12.5 k	25 M	12.5 k	25 M	12.5 k
20 µs	62.5 M	12.5 k	62.5 M	12.5 k	62.5 M	12.5 k	62.5 M	12.5 k	62.5 M	12.5 k	62.5 M	12.5 k	62.5 M	12.5 k	62.5 M	12.5 k
10 µs	125 M	12.5 k	125 M	12.5 k	125 M	12.5 k	125 M	12.5 k	125 M	12.5 k	125 M	12.5 k	125 M	12.5 k	125 M	12.5 k
5 µs	250 M	12.5 k	250 M	12.5 k	250 M	12.5 k	250 M	12.5 k	250 M	12.5 k	250 M	12.5 k	250 M	12.5 k	250 M	12.5 k
2 µs	625 M	12.5 k	625 M	12.5 k	625 M	12.5 k	625 M	12.5 k	625 M	12.5 k	625 M	12.5 k	625 M	12.5 k	625 M	12.5 k
1 µs	1.25 G	12.5 k	1.25 G	12.5 k	1.25 G	12.5 k	1.25 G	12.5 k	625 M	6.25 k	1.25 G	12.5 k	1.25 G	12.5 k	1.25 G	12.5 k
500 ns	1.25 G	6.25 k	2.5 G	12.5 k	2.5 G	12.5 k	2.5 G	12.5 k	625 M	3.125 k	2.5 G	12.5 k	1.25 G	6.25 k	2.5 G	12.5 k
200 ns	1.25 G	2.5 k	6.25 G	12.5 k	2.5 G	5 k	6.25 G	12.5 k	625 M	1.25 k	6.25 G	12.5 k	1.25 G	2.5 k	6.25 G	12.5 k
100 ns	1.25 G	1.25 k	12.5 G	12.5 k	2.5 G	2.5 k	12.5 G	12.5 k	625 M	625	12.5 G	12.5 k	1.25 G	1.25 k	12.5 G	12.5 k
50 ns	1.25 G	625	25 G	12.5 k	2.5 G	1.25 k	25 G	12.5 k	625 M	312.5	25 G	12.5 k	1.25 G	625	25 G	12.5 k
20 ns	1.25 G	250	62.5 G	12.5 k	2.5 G	500	62.5 G	12.5 k	625 M	125	62.5 G	12.5 k	1.25 G	250	62.5 G	12.5 k
10 ns	1.25 G	125	125 G	12.5 k	2.5 G	250	125 G	12.5 k	625 M	62.5	125 G	12.5 k	1.25 G	125	125 G	12.5 k
5 ns	1.25 G	62.5	125 G	6.25 k	2.5 G	125	125 G	6.25 k	625 M	31.25	125 G	6.25 k	1.25 G	62.5	125 G	6.25 k
2 ns	1.25 G	25	125 G	2.5 k	2.5 G	50	125 G	2.5 k	625 M	12.5	125 G	2.5 k	1.25 G	25	125 G	2.5 k
1 ns	1.25 G	12.5	125 G	1.25 k	2.5 G	25	125 G	1.25 k	625 M	6.25	125 G	1.25 k	1.25 G	12.5	125 G	1.25 k

Values outside of the thick borders have been calculated in real-time sampling mode.

 : Roll Mode

When the Record Length Is 125 k points

(This record length can be selected on all models)

Intrl: Interpolation Mode

Rep: Repetitive Sampling Mode

Settings Time/div	When High Resolution mode is off								When High Resolution mode is on							
	When Interleave mode is off				When Interleave mode is on				When Interleave mode is off				When Interleave mode is on			
	Realtime		Intrl/Rep		Realtime		Intrl/Rep		Realtime		Intrl/Rep		Realtime		Intrl/Rep	
	Sample Rate (S/s)	Record Length (Points)	Sample Rate (S/s)	Record Length (Points)	Sample Rate (S/s)	Record Length (Points)	Sample Rate (S/s)	Record Length (Points)	Sample Rate (S/s)	Record Length (Points)	Sample Rate (S/s)	Record Length (Points)	Sample Rate (S/s)	Record Length (Points)	Sample Rate (S/s)	Record Length (Points)
500 s	50	250 k	50	250 k	50	250 k	50	250 k	50	250 k	50	250 k	50	250 k	50	250 k
200 s	62.5	125 k	62.5	125 k	62.5	125 k	62.5	125 k	62.5	125 k	62.5	125 k	62.5	125 k	62.5	125 k
100 s	125	125 k	125	125 k	125	125 k	125	125 k	125	125 k	125	125 k	125	125 k	125	125 k
50 s	250	125 k	250	125 k	250	125 k	250	125 k	250	125 k	250	125 k	250	125 k	250	125 k
20 s	625	125 k	625	125 k	625	125 k	625	125 k	625	125 k	625	125 k	625	125 k	625	125 k
10 s	1.25 k	125 k	1.25 k	125 k	1.25 k	125 k	1.25 k	125 k	1.25 k	125 k	1.25 k	125 k	1.25 k	125 k	1.25 k	125 k
5 s	2.5 k	125 k	2.5 k	125 k	2.5 k	125 k	2.5 k	125 k	2.5 k	125 k	2.5 k	125 k	2.5 k	125 k	2.5 k	125 k
2 s	6.25 k	125 k	6.25 k	125 k	6.25 k	125 k	6.25 k	125 k	6.25 k	125 k	6.25 k	125 k	6.25 k	125 k	6.25 k	125 k
1 s	12.5 k	125 k	12.5 k	125 k	12.5 k	125 k	12.5 k	125 k	12.5 k	125 k	12.5 k	125 k	12.5 k	125 k	12.5 k	125 k
500 ms	25 k	125 k	25 k	125 k	25 k	125 k	25 k	125 k	25 k	125 k	25 k	125 k	25 k	125 k	25 k	125 k
200 ms	62.5 k	125 k	62.5 k	125 k	62.5 k	125 k	62.5 k	125 k	62.5 k	125 k	62.5 k	125 k	62.5 k	125 k	62.5 k	125 k
100 ms	125 k	125 k	125 k	125 k	125 k	125 k	125 k	125 k	125 k	125 k	125 k	125 k	125 k	125 k	125 k	125 k
50 ms	250 k	125 k	250 k	125 k	250 k	125 k	250 k	125 k	250 k	125 k	250 k	125 k	250 k	125 k	250 k	125 k
20 ms	625 k	125 k	625 k	125 k	625 k	125 k	625 k	125 k	625 k	125 k	625 k	125 k	625 k	125 k	625 k	125 k
10 ms	1.25 M	125 k	1.25 M	125 k	1.25 M	125 k	1.25 M	125 k	1.25 M	125 k	1.25 M	125 k	1.25 M	125 k	1.25 M	125 k
5 ms	2.5 M	125 k	2.5 M	125 k	2.5 M	125 k	2.5 M	125 k	2.5 M	125 k	2.5 M	125 k	2.5 M	125 k	2.5 M	125 k
2 ms	6.25 M	125 k	6.25 M	125 k	6.25 M	125 k	6.25 M	125 k	6.25 M	125 k	6.25 M	125 k	6.25 M	125 k	6.25 M	125 k
1 ms	12.5 M	125 k	12.5 M	125 k	12.5 M	125 k	12.5 M	125 k	12.5 M	125 k	12.5 M	125 k	12.5 M	125 k	12.5 M	125 k
500 µs	25 M	125 k	25 M	125 k	25 M	125 k	25 M	125 k	25 M	125 k	25 M	125 k	25 M	125 k	25 M	125 k
200 µs	62.5 M	125 k	62.5 M	125 k	62.5 M	125 k	62.5 M	125 k	62.5 M	125 k	62.5 M	125 k	62.5 M	125 k	62.5 M	125 k
100 µs	125 M	125 k	125 M	125 k	125 M	125 k	125 M	125 k	125 M	125 k	125 M	125 k	125 M	125 k	125 M	125 k
50 µs	250 M	125 k	250 M	125 k	250 M	125 k	250 M	125 k	250 M	125 k	250 M	125 k	250 M	125 k	250 M	125 k
20 µs	625 M	125 k	625 M	125 k	625 M	125 k	625 M	125 k	625 M	125 k	625 M	125 k	625 M	125 k	625 M	125 k
10 µs	1.25 G	125 k	1.25 G	125 k	1.25 G	125 k	1.25 G	125 k	625 M	62.5 k	1.25 G	125 k	1.25 G	125 k	1.25 G	125 k
5 µs	1.25 G	62.5 k	2.5 G	125 k	2.5 G	125 k	2.5 G	125 k	625 M	31.25 k	2.5 G	125 k	1.25 G	62.5 k	2.5 G	125 k
2 µs	1.25 G	25 k	6.25 G	125 k	2.5 G	50 k	6.25 G	125 k	625 M	12.5 k	6.25 G	125 k	1.25 G	25 k	6.25 G	125 k
1 µs	1.25 G	12.5 k	12.5 G	125 k	2.5 G	25 k	12.5 G	125 k	625 M	6.25 k	12.5 G	125 k	1.25 G	12.5 k	12.5 G	125 k
500 ns	1.25 G	6.25 k	25 G	125 k	2.5 G	12.5 k	25 G	125 k	625 M	3.125 k	25 G	125 k	1.25 G	6.25 k	25 G	125 k
200 ns	1.25 G	2.5 k	62.5 G	125 k	2.5 G	5 k	62.5 G	125 k	625 M	1.25 k	62.5 G	125 k	1.25 G	2.5 k	62.5 G	125 k
100 ns	1.25 G	1.25 k	125 G	125 k	2.5 G	2.5 k	125 G	125 k	625 M	625	125 G	125 k	1.25 G	1.25 k	125 G	125 k
50 ns	1.25 G	625	125 G	62.5 k	2.5 G	1.25 k	125 G	62.5 k	625 M	312.5	125 G	62.5 k	1.25 G	625	125 G	62.5 k
20 ns	1.25 G	250	125 G	25 k	2.5 G	500	125 G	25 k	625 M	125	125 G	25 k	1.25 G	250	125 G	25 k
10 ns	1.25 G	125	125 G	12.5 k	2.5 G	250	125 G	12.5 k	625 M	62.5	125 G	12.5 k	1.25 G	125	125 G	12.5 k
5 ns	1.25 G	62.5	125 G	6.25 k	2.5 G	125	125 G	6.25 k	625 M	31.25	125 G	6.25 k	1.25 G	62.5	125 G	6.25 k
2 ns	1.25 G	25	125 G	2.5 k	2.5 G	50	125 G	2.5 k	625 M	12.5	125 G	2.5 k	1.25 G	25	125 G	2.5 k
1 ns	1.25 G	12.5	125 G	1.25 k	2.5 G	25	125 G	1.25 k	625 M	6.25	125 G	1.25 k	1.25 G	12.5	125 G	1.25 k

Values outside of the thick borders have been calculated in real-time sampling mode.

: Roll Mode

Appendix 1 Relationship between the Time Axis Setting, Record Length, and Sample Rate

When the Record Length Is 1.25 M points

(This record length can be selected on all models)

Intpl: Interpolation Mode
Rep: Repetitive Sampling Mode

Settings Time/div	When High Resolution mode is off								When High Resolution mode is on							
	When Interleave mode is off				When Interleave mode is on				When Interleave mode is off				When Interleave mode is on			
	Realtime		Intpl/Rep		Realtime		Intpl/Rep		Realtime		Intpl/Rep		Realtime		Intpl/Rep	
	Sample Rate (S/s)	Record Length (Points)	Sample Rate (S/s)	Record Length (Points)	Sample Rate (S/s)	Record Length (Points)	Sample Rate (S/s)	Record Length (Points)	Sample Rate (S/s)	Record Length (Points)	Sample Rate (S/s)	Record Length (Points)	Sample Rate (S/s)	Record Length (Points)	Sample Rate (S/s)	Record Length (Points)
500 s	250	1.25 M	250	1.25 M	250	1.25 M	250	1.25 M	250	1.25 M	250	1.25 M	250	1.25 M	250	1.25 M
200 s	625	1.25 M	625	1.25 M	625	1.25 M	625	1.25 M	625	1.25 M	625	1.25 M	625	1.25 M	625	1.25 M
100 s	1.25 k	1.25 M	1.25 k	1.25 M	1.25 k	1.25 M	1.25 k	1.25 M	1.25 k	1.25 M	1.25 k	1.25 M	1.25 k	1.25 M	1.25 k	1.25 M
50 s	2.5 k	1.25 M	2.5 k	1.25 M	2.5 k	1.25 M	2.5 k	1.25 M	2.5 k	1.25 M	2.5 k	1.25 M	2.5 k	1.25 M	2.5 k	1.25 M
20 s	6.25 k	1.25 M	6.25 k	1.25 M	6.25 k	1.25 M	6.25 k	1.25 M	6.25 k	1.25 M	6.25 k	1.25 M	6.25 k	1.25 M	6.25 k	1.25 M
10 s	12.5 k	1.25 M	12.5 k	1.25 M	12.5 k	1.25 M	12.5 k	1.25 M	12.5 k	1.25 M	12.5 k	1.25 M	12.5 k	1.25 M	12.5 k	1.25 M
5 s	25 k	1.25 M	25 k	1.25 M	25 k	1.25 M	25 k	1.25 M	25 k	1.25 M	25 k	1.25 M	25 k	1.25 M	25 k	1.25 M
2 s	62.5 k	1.25 M	62.5 k	1.25 M	62.5 k	1.25 M	62.5 k	1.25 M	62.5 k	1.25 M	62.5 k	1.25 M	62.5 k	1.25 M	62.5 k	1.25 M
1 s	125 k	1.25 M	125 k	1.25 M	125 k	1.25 M	125 k	1.25 M	125 k	1.25 M	125 k	1.25 M	125 k	1.25 M	125 k	1.25 M
500 ms	250 k	1.25 M	250 k	1.25 M	250 k	1.25 M	250 k	1.25 M	250 k	1.25 M	250 k	1.25 M	250 k	1.25 M	250 k	1.25 M
200 ms	625 k	1.25 M	625 k	1.25 M	625 k	1.25 M	625 k	1.25 M	625 k	1.25 M	625 k	1.25 M	625 k	1.25 M	625 k	1.25 M
100 ms	1.25 M	1.25 M	1.25 M	1.25 M	1.25 M	1.25 M	1.25 M	1.25 M	1.25 M	1.25 M	1.25 M	1.25 M	1.25 M	1.25 M	1.25 M	1.25 M
50 ms	2.5 M	1.25 M	2.5 M	1.25 M	2.5 M	1.25 M	2.5 M	1.25 M	2.5 M	1.25 M	2.5 M	1.25 M	2.5 M	1.25 M	2.5 M	1.25 M
20 ms	6.25 M	1.25 M	6.25 M	1.25 M	6.25 M	1.25 M	6.25 M	1.25 M	6.25 M	1.25 M	6.25 M	1.25 M	6.25 M	1.25 M	6.25 M	1.25 M
10 ms	12.5 M	1.25 M	12.5 M	1.25 M	12.5 M	1.25 M	12.5 M	1.25 M	12.5 M	1.25 M	12.5 M	1.25 M	12.5 M	1.25 M	12.5 M	1.25 M
5 ms	25 M	1.25 M	25 M	1.25 M	25 M	1.25 M	25 M	1.25 M	25 M	1.25 M	25 M	1.25 M	25 M	1.25 M	25 M	1.25 M
2 ms	62.5 M	1.25 M	62.5 M	1.25 M	62.5 M	1.25 M	62.5 M	1.25 M	62.5 M	1.25 M	62.5 M	1.25 M	62.5 M	1.25 M	62.5 M	1.25 M
1 ms	125 M	1.25 M	125 M	1.25 M	125 M	1.25 M	125 M	1.25 M	125 M	1.25 M	125 M	1.25 M	125 M	1.25 M	125 M	1.25 M
500 μs	250 M	1.25 M	250 M	1.25 M	250 M	1.25 M	250 M	1.25 M	250 M	1.25 M	250 M	1.25 M	250 M	1.25 M	250 M	1.25 M
200 μs	625 M	1.25 M	625 M	1.25 M	625 M	1.25 M	625 M	1.25 M	625 M	1.25 M	625 M	1.25 M	625 M	1.25 M	625 M	1.25 M
100 μs	1.25 G	1.25 M	1.25 G	1.25 M	1.25 G	1.25 M	1.25 G	1.25 M	625 M	625 k	1.25 G	1.25 M	1.25 G	1.25 M	1.25 G	1.25 M
50 μs	1.25 G	625 k	2.5 G	1.25 M	2.5 G	1.25 M	2.5 G	1.25 M	625 M	312.5 k	2.5 G	1.25 M	1.25 G	625 k	2.5 G	1.25 M
20 μs	1.25 G	250 k	6.25 G	1.25 M	2.5 G	500 k	6.25 G	1.25 M	625 M	125 k	6.25 G	1.25 M	1.25 G	250 k	6.25 G	1.25 M
10 μs	1.25 G	125 k	12.5 G	1.25 M	2.5 G	250 k	12.5 G	1.25 M	625 M	62.5 k	12.5 G	1.25 M	1.25 G	125 k	12.5 G	1.25 M
5 μs	1.25 G	62.5 k	25 G	1.25 M	2.5 G	125 k	25 G	1.25 M	625 M	31.25 k	25 G	1.25 M	1.25 G	62.5 k	25 G	1.25 M
2 μs	1.25 G	25 k	62.5 G	1.25 M	2.5 G	50 k	62.5 G	1.25 M	625 M	12.5 k	62.5 G	1.25 M	1.25 G	25 k	62.5 G	1.25 M
1 μs	1.25 G	12.5 k	125 G	1.25 M	2.5 G	25 k	125 G	1.25 M	625 M	6.25 k	125 G	1.25 M	1.25 G	12.5 k	125 G	1.25 M
500 ns	1.25 G	6.25 k	125 G	625 k	2.5 G	12.5 k	125 G	625 k	625 M	3.125 k	125 G	625 k	1.25 G	6.25 k	125 G	625 k
200 ns	1.25 G	2.5 k	125 G	250 k	2.5 G	5 k	125 G	250 k	625 M	1.25 k	125 G	250 k	1.25 G	2.5 k	125 G	250 k
100 ns	1.25 G	1.25 k	125 G	125 k	2.5 G	2.5 k	125 G	125 k	625 M	625	125 G	125 k	1.25 G	1.25 k	125 G	125 k
50 ns	1.25 G	625	125 G	62.5 k	2.5 G	1.25 k	125 G	62.5 k	625 M	312.5	125 G	62.5 k	1.25 G	625	125 G	62.5 k
20 ns	1.25 G	250	125 G	25 k	2.5 G	500	125 G	25 k	625 M	125	125 G	25 k	1.25 G	250	125 G	25 k
10 ns	1.25 G	125	125 G	12.5 k	2.5 G	250	125 G	12.5 k	625 M	62.5	125 G	12.5 k	1.25 G	125	125 G	12.5 k
5 ns	1.25 G	62.5	125 G	6.25 k	2.5 G	125	125 G	6.25 k	625 M	31.25	125 G	6.25 k	1.25 G	62.5	125 G	6.25 k
2 ns	1.25 G	25	125 G	2.5 k	2.5 G	50	125 G	2.5 k	625 M	12.5	125 G	2.5 k	1.25 G	25	125 G	2.5 k
1 ns	1.25 G	12.5	125 G	1.25 k	2.5 G	25	125 G	1.25 k	625 M	6.25	125 G	1.25 k	1.25 G	12.5	125 G	1.25 k

Values outside of the thick borders have been calculated in real-time sampling mode.

 : Roll Mode

When the Record Length Is 6.25 M points

(This record length can be selected when there is no memory option or on DLM2000s with the /M1(S) option)

Intpl: Interpolation Mode
Rep: Repetitive Sampling Mode

Settings Time/div	When High Resolution mode is off								When High Resolution mode is on ¹							
	When Interleave mode is off				When Interleave mode is on				When Interleave mode is off				When Interleave mode is on			
	Realtime		Intpl/Rep ²		Realtime		Intpl/Rep ²		Realtime		Intpl/Rep		Realtime		Intpl/Rep	
	Sample Rate (S/s)	Record Length (Points)	Sample Rate (S/s)	Record Length (Points)	Sample Rate (S/s)	Record Length (Points)	Sample Rate (S/s)	Record Length (Points)	Sample Rate (S/s)	Record Length (Points)	Sample Rate (S/s)	Record Length (Points)	Sample Rate (S/s)	Record Length (Points)	Sample Rate (S/s)	Record Length (Points)
500 s	1.25 k	6.25 M	1.25 k	6.25 M	1.25 k	6.25 M	1.25 k	6.25 M	1.25 k	6.25 M	1.25 k	6.25 M	1.25 k	6.25 M	1.25 k	6.25 M
200 s	3.125 k	6.25 M	3.125 k	6.25 M	3.125 k	6.25 M	3.125 k	6.25 M	3.125 k	6.25 M	3.125 k	6.25 M	3.125 k	6.25 M	3.125 k	6.25 M
100 s	6.25 k	6.25 M	6.25 k	6.25 M	6.25 k	6.25 M	6.25 k	6.25 M	6.25 k	6.25 M	6.25 k	6.25 M	6.25 k	6.25 M	6.25 k	6.25 M
50 s	12.5 k	6.25 M	12.5 k	6.25 M	12.5 k	6.25 M	12.5 k	6.25 M	12.5 k	6.25 M	12.5 k	6.25 M	12.5 k	6.25 M	12.5 k	6.25 M
20 s	31.25 k	6.25 M	31.25 k	6.25 M	31.25 k	6.25 M	31.25 k	6.25 M	31.25 k	6.25 M	31.25 k	6.25 M	31.25 k	6.25 M	31.25 k	6.25 M
10 s	62.5 k	6.25 M	62.5 k	6.25 M	62.5 k	6.25 M	62.5 k	6.25 M	62.5 k	6.25 M	62.5 k	6.25 M	62.5 k	6.25 M	62.5 k	6.25 M
5 s	125 k	6.25 M	125 k	6.25 M	125 k	6.25 M	125 k	6.25 M	125 k	6.25 M	125 k	6.25 M	125 k	6.25 M	125 k	6.25 M
2 s	312.5 k	6.25 M	312.5 k	6.25 M	312.5 k	6.25 M	312.5 k	6.25 M	312.5 k	6.25 M	312.5 k	6.25 M	312.5 k	6.25 M	312.5 k	6.25 M
1 s	625 k	6.25 M	625 k	6.25 M	625 k	6.25 M	625 k	6.25 M	625 k	6.25 M	625 k	6.25 M	625 k	6.25 M	625 k	6.25 M
500 ms	1.25 M	6.25 M	1.25 M	6.25 M	1.25 M	6.25 M	1.25 M	6.25 M	1.25 M	6.25 M	1.25 M	6.25 M	1.25 M	6.25 M	1.25 M	6.25 M
200 ms	3.125 M	6.25 M	3.125 M	6.25 M	3.125 M	6.25 M	3.125 M	6.25 M	3.125 M	6.25 M	3.125 M	6.25 M	3.125 M	6.25 M	3.125 M	6.25 M
100 ms	6.25 M	6.25 M	6.25 M	6.25 M	6.25 M	6.25 M	6.25 M	6.25 M	6.25 M	6.25 M	6.25 M	6.25 M	6.25 M	6.25 M	6.25 M	6.25 M
50 ms	12.5 M	6.25 M	12.5 M	6.25 M	12.5 M	6.25 M	12.5 M	6.25 M	12.5 M	6.25 M	12.5 M	6.25 M	12.5 M	6.25 M	12.5 M	6.25 M
20 ms	31.25 M	6.25 M	31.25 M	6.25 M	31.25 M	6.25 M	31.25 M	6.25 M	31.25 M	6.25 M	31.25 M	6.25 M	31.25 M	6.25 M	31.25 M	6.25 M
10 ms	62.5 M	6.25 M	62.5 M	6.25 M	62.5 M	6.25 M	62.5 M	6.25 M	62.5 M	6.25 M	62.5 M	6.25 M	62.5 M	6.25 M	62.5 M	6.25 M
5 ms	125 M	6.25 M	125 M	6.25 M	125 M	6.25 M	125 M	6.25 M	125 M	6.25 M	125 M	6.25 M	125 M	6.25 M	125 M	6.25 M
2 ms	312.5 M	6.25 M	312.5 M	6.25 M	312.5 M	6.25 M	312.5 M	6.25 M	312.5 M	6.25 M	312.5 M	6.25 M	312.5 M	6.25 M	312.5 M	6.25 M
1 ms	625 M	6.25 M	625 M	6.25 M	625 M	6.25 M	625 M	6.25 M	625 M	6.25 M	625 M	6.25 M	625 M	6.25 M	625 M	6.25 M
500 µs	1.25 G	6.25 M	1.25 G	6.25 M	1.25 G	6.25 M	1.25 G	6.25 M	625 M	3.125 M	1.25 G	6.25 M	1.25 G	6.25 M	1.25 G	6.25 M
200 µs	1.25 G	2.5 M	3.125 G	6.25 M	2.5 G	5 M	3.125 G	6.25 M	625 M	1.25 M	3.125 G	6.25 M	1.25 G	2.5 M	3.125 G	6.25 M
100 µs	1.25 G	1.25 M	6.25 G	6.25 M	2.5 G	2.5 M	6.25 G	6.25 M	625 M	625 k	6.25 G	6.25 M	1.25 G	1.25 M	6.25 G	6.25 M
50 µs	1.25 G	625 k	12.5 G	6.25 M	2.5 G	1.25 M	12.5 G	6.25 M	625 M	312.5 k	12.5 G	6.25 M	1.25 G	625 k	12.5 G	6.25 M
20 µs	1.25 G	250 k	31.25 G	6.25 M	2.5 G	500 k	31.25 G	6.25 M	625 M	125 k	31.25 G	6.25 M	1.25 G	250 k	31.25 G	6.25 M
10 µs	1.25 G	125 k	62.5 G	6.25 M	2.5 G	250 k	62.5 G	6.25 M	625 M	62.5 k	62.5 G	6.25 M	1.25 G	125 k	62.5 G	6.25 M
5 µs	1.25 G	62.5 k	125 G	6.25 M	2.5 G	125 k	125 G	6.25 M	625 M	31.25 k	125 G	6.25 M	1.25 G	62.5 k	125 G	6.25 M
2 µs	1.25 G	25 k	125 G	2.5 M	2.5 G	50 k	125 G	2.5 M	625 M	12.5 k	125 G	2.5 M	1.25 G	25 k	125 G	2.5 M
1 µs	1.25 G	12.5 k	125 G	1.25 M	2.5 G	25 k	125 G	1.25 M	625 M	6.25 k	125 G	1.25 M	1.25 G	12.5 k	125 G	1.25 M
500 ns	1.25 G	6.25 k	125 G	625 k	2.5 G	12.5 k	125 G	625 k	625 M	3.125 k	125 G	625 k	1.25 G	6.25 k	125 G	625 k
200 ns	1.25 G	2.5 k	125 G	250 k	2.5 G	5 k	125 G	250 k	625 M	1.25 k	125 G	250 k	1.25 G	2.5 k	125 G	250 k
100 ns	1.25 G	1.25 k	125 G	125 k	2.5 G	2.5 k	125 G	125 k	625 M	625	125 G	125 k	1.25 G	1.25 k	125 G	125 k
50 ns	1.25 G	625	125 G	62.5 k	2.5 G	1.25 k	125 G	62.5 k	625 M	312.5	125 G	62.5 k	1.25 G	625	125 G	62.5 k
20 ns	1.25 G	250	125 G	25 k	2.5 G	500	125 G	25 k	625 M	125	125 G	25 k	1.25 G	250	125 G	25 k
10 ns	1.25 G	125	125 G	12.5 k	2.5 G	250	125 G	12.5 k	625 M	62.5	125 G	12.5 k	1.25 G	125	125 G	12.5 k
5 ns	1.25 G	62.5	125 G	6.25 k	2.5 G	125	125 G	6.25 k	625 M	31.25	125 G	6.25 k	1.25 G	62.5	125 G	6.25 k
2 ns	1.25 G	25	125 G	2.5 k	2.5 G	50	125 G	2.5 k	625 M	12.5	125 G	2.5 k	1.25 G	25	125 G	2.5 k
1 ns	1.25 G	12.5	125 G	1.25 k	2.5 G	25	125 G	1.25 k	625 M	6.25	125 G	1.25 k	1.25 G	12.5	125 G	1.25 k

Values outside of the thick borders have been calculated in real-time sampling mode.

If there is no memory option, acquisition with this record length is performed in single mode.

1 If there is no memory option, high resolution mode cannot be used with this record length.

2 If there is no memory option, interpolation mode and repetitive sampling mode cannot be used with this record length.

: Roll Mode

Appendix 1 Relationship between the Time Axis Setting, Record Length, and Sample Rate

When the Record Length Is 12.5 M points

(This record length can be selected when there is no memory option or on DLM2000s with the /M2 option)

Intpl: Interpolation Mode
Rep: Repetitive Sampling Mode

Settings Time/div	When High Resolution mode is off								When High Resolution mode is on ¹							
	When Interleave mode is off ²				When Interleave mode is on				When Interleave mode is off				When Interleave mode is on			
	Realtime		Intpl/Rep		Realtime		Intpl/Rep ³		Realtime		Intpl/Rep		Realtime		Intpl/Rep	
	Sample Rate (S/s)	Record Length (Points)	Sample Rate (S/s)	Record Length (Points)	Sample Rate (S/s)	Record Length (Points)	Sample Rate (S/s)	Record Length (Points)	Sample Rate (S/s)	Record Length (Points)	Sample Rate (S/s)	Record Length (Points)	Sample Rate (S/s)	Record Length (Points)	Sample Rate (S/s)	Record Length (Points)
500 s	2.5 k	12.5 M	2.5 k	12.5 M	2.5 k	12.5 M	2.5 k	12.5 M	2.5 k	12.5 M	2.5 k	12.5 M	2.5 k	12.5 M	2.5 k	12.5 M
200 s	6.25 k	12.5 M	6.25 k	12.5 M	6.25 k	12.5 M	6.25 k	12.5 M	6.25 k	12.5 M	6.25 k	12.5 M	6.25 k	12.5 M	6.25 k	12.5 M
100 s	12.5 k	12.5 M	12.5 k	12.5 M	12.5 k	12.5 M	12.5 k	12.5 M	12.5 k	12.5 M	12.5 k	12.5 M	12.5 k	12.5 M	12.5 k	12.5 M
50 s	25 k	12.5 M	25 k	12.5 M	25 k	12.5 M	25 k	12.5 M	25 k	12.5 M	25 k	12.5 M	25 k	12.5 M	25 k	12.5 M
20 s	62.5 k	12.5 M	62.5 k	12.5 M	62.5 k	12.5 M	62.5 k	12.5 M	62.5 k	12.5 M	62.5 k	12.5 M	62.5 k	12.5 M	62.5 k	12.5 M
10 s	125 k	12.5 M	125 k	12.5 M	125 k	12.5 M	125 k	12.5 M	125 k	12.5 M	125 k	12.5 M	125 k	12.5 M	125 k	12.5 M
5 s	250 k	12.5 M	250 k	12.5 M	250 k	12.5 M	250 k	12.5 M	250 k	12.5 M	250 k	12.5 M	250 k	12.5 M	250 k	12.5 M
2 s	625 k	12.5 M	625 k	12.5 M	625 k	12.5 M	625 k	12.5 M	625 k	12.5 M	625 k	12.5 M	625 k	12.5 M	625 k	12.5 M
1 s	1.25 M	12.5 M	1.25 M	12.5 M	1.25 M	12.5 M	1.25 M	12.5 M	1.25 M	12.5 M	1.25 M	12.5 M	1.25 M	12.5 M	1.25 M	12.5 M
500 ms	2.5 M	12.5 M	2.5 M	12.5 M	2.5 M	12.5 M	2.5 M	12.5 M	2.5 M	12.5 M	2.5 M	12.5 M	2.5 M	12.5 M	2.5 M	12.5 M
200 ms	6.25 M	12.5 M	6.25 M	12.5 M	6.25 M	12.5 M	6.25 M	12.5 M	6.25 M	12.5 M	6.25 M	12.5 M	6.25 M	12.5 M	6.25 M	12.5 M
100 ms	12.5 M	12.5 M	12.5 M	12.5 M	12.5 M	12.5 M	12.5 M	12.5 M	12.5 M	12.5 M	12.5 M	12.5 M	12.5 M	12.5 M	12.5 M	12.5 M
50 ms	25 M	12.5 M	25 M	12.5 M	25 M	12.5 M	25 M	12.5 M	25 M	12.5 M	25 M	12.5 M	25 M	12.5 M	25 M	12.5 M
20 ms	62.5 M	12.5 M	62.5 M	12.5 M	62.5 M	12.5 M	62.5 M	12.5 M	62.5 M	12.5 M	62.5 M	12.5 M	62.5 M	12.5 M	62.5 M	12.5 M
10 ms	125 M	12.5 M	125 M	12.5 M	125 M	12.5 M	125 M	12.5 M	125 M	12.5 M	125 M	12.5 M	125 M	12.5 M	125 M	12.5 M
5 ms	250 M	12.5 M	250 M	12.5 M	250 M	12.5 M	250 M	12.5 M	250 M	12.5 M	250 M	12.5 M	250 M	12.5 M	250 M	12.5 M
2 ms	625 M	12.5 M	625 M	12.5 M	625 M	12.5 M	625 M	12.5 M	625 M	12.5 M	625 M	12.5 M	625 M	12.5 M	625 M	12.5 M
1 ms	1.25 G	12.5 M	1.25 G	12.5 M	1.25 G	12.5 M	1.25 G	12.5 M	625 M	6.25 M	1.25 G	12.5 M	1.25 G	12.5 M	1.25 G	12.5 M
500 μs	1.25 G	6.25 M	2.5 G	12.5 M	2.5 G	12.5 M	2.5 G	12.5 M	625 M	3.125 M	2.5 G	12.5 M	1.25 G	6.25 M	2.5 G	12.5 M
200 μs	1.25 G	2.5 M	6.25 G	12.5 M	2.5 G	5 M	6.25 G	12.5 M	625 M	1.25 M	6.25 G	12.5 M	1.25 G	2.5 M	6.25 G	12.5 M
100 μs	1.25 G	1.25 M	12.5 G	12.5 M	2.5 G	2.5 M	12.5 G	12.5 M	625 M	625 k	12.5 G	12.5 M	1.25 G	1.25 M	12.5 G	12.5 M
50 μs	1.25 G	625 k	25 G	12.5 M	2.5 G	1.25 M	25 G	12.5 M	625 M	312.5 k	25 G	12.5 M	1.25 G	625 k	25 G	12.5 M
20 μs	1.25 G	250 k	62.5 G	12.5 M	2.5 G	500 k	62.5 G	12.5 M	625 M	125 k	62.5 G	12.5 M	1.25 G	250 k	62.5 G	12.5 M
10 μs	1.25 G	125 k	125 G	12.5 M	2.5 G	250 k	125 G	12.5 M	625 M	62.5 k	125 G	12.5 M	1.25 G	125 k	125 G	12.5 M
5 μs	1.25 G	62.5 k	125 G	6.25 M	2.5 G	125 k	125 G	6.25 M	625 M	31.25 k	125 G	6.25 M	1.25 G	62.5 k	125 G	6.25 M
2 μs	1.25 G	25 k	125 G	2.5 M	2.5 G	50 k	125 G	2.5 M	625 M	12.5 k	125 G	2.5 M	1.25 G	25 k	125 G	2.5 M
1 μs	1.25 G	12.5 k	125 G	1.25 M	2.5 G	25 k	125 G	1.25 M	625 M	6.25 k	125 G	1.25 M	1.25 G	12.5 k	125 G	1.25 M
500 ns	1.25 G	6.25 k	125 G	625 k	2.5 G	12.5 k	125 G	625 k	625 M	3.125 k	125 G	625 k	1.25 G	6.25 k	125 G	625 k
200 ns	1.25 G	2.5 k	125 G	250 k	2.5 G	5 k	125 G	250 k	625 M	1.25 k	125 G	250 k	1.25 G	2.5 k	125 G	250 k
100 ns	1.25 G	1.25 k	125 G	125 k	2.5 G	2.5 k	125 G	125 k	625 M	625	125 G	125 k	1.25 G	1.25 k	125 G	125 k
50 ns	1.25 G	625	125 G	62.5 k	2.5 G	1.25 k	125 G	62.5 k	625 M	312.5	125 G	62.5 k	1.25 G	625	125 G	62.5 k
20 ns	1.25 G	250	125 G	25 k	2.5 G	500	125 G	25 k	625 M	125	125 G	25 k	1.25 G	250	125 G	25 k
10 ns	1.25 G	125	125 G	12.5 k	2.5 G	250	125 G	12.5 k	625 M	62.5	125 G	12.5 k	1.25 G	125	125 G	12.5 k
5 ns	1.25 G	62.5	125 G	6.25 k	2.5 G	125	125 G	6.25 k	625 M	31.25	125 G	6.25 k	1.25 G	62.5	125 G	6.25 k
2 ns	1.25 G	25	125 G	2.5 k	2.5 G	50	125 G	2.5 k	625 M	12.5	125 G	2.5 k	1.25 G	25	125 G	2.5 k
1 ns	1.25 G	12.5	125 G	1.25 k	2.5 G	25	125 G	1.25 k	625 M	6.25	125 G	1.25 k	1.25 G	12.5	125 G	1.25 k

Values outside of the thick borders have been calculated in real-time sampling mode.

If there is no memory option, acquisition with this record length is performed in single mode.

1 If there is no memory option, high resolution mode cannot be used with this record length.

2 If there is no memory option, with this record length, interleave mode cannot be turned off.

3 If there is no memory option, interpolation mode and repetitive sampling mode cannot be used with this record length.

 : Roll Mode

When the Record Length Is 25 M points

(This record length can be selected on DLM2000s with the /M1(S) or /M3 option)

Intpl: Interpolation Mode

Rep: Repetitive Sampling Mode

Settings Time/div	When High Resolution mode is off								When High Resolution mode is on ¹							
	When Interleave mode is off				When Interleave mode is on				When Interleave mode is off				When Interleave mode is on			
	Realtime		Intpl/Rep ²		Realtime		Intpl/Rep ²		Realtime		Intpl/Rep		Realtime		Intpl/Rep	
	Sample Rate (S/s)	Record Length (Points)	Sample Rate (S/s)	Record Length (Points)	Sample Rate (S/s)	Record Length (Points)	Sample Rate (S/s)	Record Length (Points)	Sample Rate (S/s)	Record Length (Points)	Sample Rate (S/s)	Record Length (Points)	Sample Rate (S/s)	Record Length (Points)	Sample Rate (S/s)	Record Length (Points)
500 s	5 k	25 M	5k	25M	5 k	25 M	5k	25M	5k	25M	5k	25M	5k	25M	5k	25M
200 s	12.5 k	25 M	12.5k	25M	12.5 k	25 M	12.5k	25M	12.5k	25M	12.5k	25M	12.5k	25M	12.5k	25M
100 s	25 k	25 M	25k	25M	25 k	25 M	25k	25M	25k	25M	25k	25M	25k	25M	25k	25M
50 s	50 k	25 M	50k	25M	50 k	25 M	50k	25M	50k	25M	50k	25M	50k	25M	50k	25M
20 s	125 k	25 M	125k	25M	125 k	25 M	125k	25M	125k	25M	125k	25M	125k	25M	125k	25M
10 s	250 k	25 M	250k	25M	250 k	25 M	250k	25M	250k	25M	250k	25M	250k	25M	250k	25M
5 s	500 k	25 M	500k	25M	500 k	25 M	500k	25M	500k	25M	500k	25M	500k	25M	500k	25M
2 s	1.25 M	25 M	1.25M	25M	1.25 M	25 M	1.25M	25M	1.25M	25M	1.25M	25M	1.25M	25M	1.25M	25M
1 s	2.5 M	25 M	2.5M	25M	2.5 M	25 M	2.5M	25M	2.5M	25M	2.5M	25M	2.5M	25M	2.5M	25M
500 ms	5 M	25 M	5M	25M	5 M	25 M	5M	25M	5M	25M	5M	25M	5M	25M	5M	25M
200 ms	12.5 M	25 M	12.5M	25M	12.5 M	25 M	12.5M	25M	12.5M	25M	12.5M	25M	12.5M	25M	12.5M	25M
100 ms	25 M	25 M	25M	25M	25 M	25 M	25M	25M	25M	25M	25M	25M	25M	25M	25M	25M
50 ms	25 M	12.5 M	25M	12.5M	25 M	12.5 M	25M	12.5M	25M	12.5M	25M	12.5M	25M	12.5M	25M	12.5M
20 ms	125 M	25 M	125M	25M	125 M	25 M	125M	25M	125M	25M	125M	25M	125M	25M	125M	25M
10 ms	250 M	25 M	250M	25M	250 M	25 M	250M	25M	250M	25M	250M	25M	250M	25M	250M	25M
5 ms	250 M	12.5 M	250M	12.5M	250 M	12.5 M	250M	12.5M	250M	12.5M	250M	12.5M	250M	12.5M	250M	12.5M
2 ms	1.25 G	25 M	1.25G	25M	1.25 G	25 M	1.25G	25M	625M	12.5M	1.25G	25M	1.25G	25M	1.25G	25M
1 ms	1.25 G	12.5 M	2.5G	25M	2.5 G	25 M	2.5G	25M	625M	6.25M	2.5G	25M	1.25G	12.5M	2.5G	25M
500 μs	1.25 G	6.25 M	5G	25M	2.5 G	12.5 M	5G	25M	625M	3.125M	5G	25M	1.25G	6.25M	5G	25M
200 μs	1.25 G	2.5 M	12.5G	25M	2.5 G	5 M	12.5G	25M	625M	1.25M	12.5G	25M	1.25G	2.5M	12.5G	25M
100 μs	1.25 G	1.25 M	25G	25M	2.5 G	2.5 M	25G	25M	625M	625k	25G	25M	1.25G	1.25M	25G	25M
50 μs	1.25 G	625 k	50G	25M	2.5 G	1.25 M	50G	25M	625M	312.5k	50G	25M	1.25G	625k	50G	25M
20 μs	1.25 G	250 k	125G	25M	2.5 G	500 k	125G	25M	625M	125k	125G	25M	1.25G	250k	125G	25M
10 μs	1.25 G	125 k	125G	12.5M	2.5 G	250 k	125G	12.5M	625M	62.5k	125G	12.5M	1.25G	125k	125G	12.5M
5 μs	1.25 G	62.5 k	125G	6.25M	2.5 G	125 k	125G	6.25M	625M	31.25k	125G	6.25M	1.25G	62.5k	125G	6.25M
2 μs	1.25 G	25 k	125G	2.5M	2.5 G	50 k	125G	2.5M	625M	12.5k	125G	2.5M	1.25G	25k	125G	2.5M
1 μs	1.25 G	12.5 k	125G	1.25M	2.5 G	25 k	125G	1.25M	625M	6.25k	125G	1.25M	1.25G	12.5k	125G	1.25M
500 ns	1.25 G	6.25 k	125G	625k	2.5 G	12.5 k	125G	625k	625M	3.125k	125G	625k	1.25G	6.25k	125G	625k
200 ns	1.25 G	2.5 k	125G	250k	2.5 G	5 k	125G	250k	625M	1.25k	125G	250k	1.25G	2.5k	125G	250k
100 ns	1.25 G	1.25 k	125G	125k	2.5 G	2.5 k	125G	125k	625M	625	125G	125k	1.25G	1.25k	125G	125k
50 ns	1.25 G	625	125G	62.5k	2.5 G	1.25 k	125G	62.5k	625M	312.5	125G	62.5k	1.25G	625	125G	62.5k
20 ns	1.25 G	250	125G	25k	2.5 G	500	125G	25k	625M	125	125G	25k	1.25G	250	125G	25k
10 ns	1.25 G	125	125G	12.5k	2.5 G	250	125G	12.5k	625M	62.5	125G	12.5k	1.25G	125	125G	12.5k
5 ns	1.25 G	62.5	125G	6.25k	2.5 G	125	125G	6.25k	625M	31.25	125G	6.25k	1.25G	62.5	125G	6.25k
2 ns	1.25 G	25	125G	2.5k	2.5 G	50	125G	2.5k	625M	12.5	125G	2.5k	1.25G	25	125G	2.5k
1 ns	1.25 G	12.5	125G	1.25k	2.5 G	25	125G	1.25k	625M	6.25	125G	1.25k	1.25G	12.5	125G	1.25k

Values outside of the thick borders have been calculated in real-time sampling mode.

On DLM2000s with the /M1(S) option, acquisition with this record length is performed in single mode.

1 On DLM2000s with the /M1(S) option, high resolution mode cannot be used with this record length.

2 On DLM2000s with the /M1(S) option, interpolation mode and repetitive sampling mode cannot be used with this record length.

: Roll Mode

Appendix 1 Relationship between the Time Axis Setting, Record Length, and Sample Rate

When the Record Length Is 62.5 M points

(This record length can be selected on DLM2000s with the /M1(S) or /M2 option)

Intpl: Interpolation Mode

Rep: Repetitive Sampling Mode

Settings Time/div	When High Resolution mode is off								When High Resolution mode is on							
	When Interleave mode is off*				When Interleave mode is on				When Interleave mode is off				When Interleave mode is on			
	Realtime		Intpl/Rep		Realtime		Intpl/Rep		Realtime		Intpl/Rep		Realtime		Intpl/Rep	
	Sample Rate (S/s)	Record Length (Points)	Sample Rate (S/s)	Record Length (Points)	Sample Rate (S/s)	Record Length (Points)	Sample Rate (S/s)	Record Length (Points)	Sample Rate (S/s)	Record Length (Points)	Sample Rate (S/s)	Record Length (Points)	Sample Rate (S/s)	Record Length (Points)	Sample Rate (S/s)	Record Length (Points)
500 s	12.5 k	62.5 M			12.5 k	62.5 M										
200 s	31.25 k	62.5 M			31.25 k	62.5 M										
100 s	62.5 k	62.5 M			62.5 k	62.5 M										
50 s	125 k	62.5 M			125 k	62.5 M										
20 s	312.5 k	62.5 M			312.5 k	62.5 M										
10 s	625 k	62.5 M			625 k	62.5 M										
5 s	1.25 M	62.5 M			1.25 M	62.5 M										
2 s	3.125 M	62.5 M			3.125 M	62.5 M										
1 s	6.25 M	62.5 M			6.25 M	62.5 M										
500 ms	12.5 M	62.5 M			12.5 M	62.5 M										
200 ms	31.25 M	62.5 M			31.25 M	62.5 M										
100 ms	62.5 M	62.5 M			62.5 M	62.5 M										
50 ms	125 M	62.5 M			125 M	62.5 M										
20 ms	312.5 M	62.5 M			312.5 M	62.5 M										
10 ms	625 M	62.5 M			625 M	62.5 M										
5 ms	1.25 G	62.5 M	Interpolation mode and repetitive sampling mode cannot be used when you specify this record length.		1.25 G	62.5 M	Interpolation mode and repetitive sampling mode cannot be used when you specify this record length.									When you specify this record length, high resolution mode cannot be turned on.
2 ms	1.25 G	25 M			2.5 G	50 M										
1 ms	1.25 G	12.5 M			2.5 G	25 M										
500 μs	1.25 G	6.25 M			2.5 G	12.5 M										
200 μs	1.25 G	2.5 M			2.5 G	5 M										
100 μs	1.25 G	1.25 M			2.5 G	2.5 M										
50 μs	1.25 G	625 k			2.5 G	1.25 M										
20 μs	1.25 G	250 k			2.5 G	500 k										
10 μs	1.25 G	125 k			2.5 G	250 k										
5 μs	1.25 G	62.5 k			2.5 G	125 k										
2 μs	1.25 G	25 k			2.5 G	50 k										
1 μs	1.25 G	12.5 k			2.5 G	25 k										
500 ns	1.25 G	6.25 k			2.5 G	12.5 k										
200 ns	1.25 G	2.5 k			2.5 G	5 k										
100 ns	1.25 G	1.25 k			2.5 G	2.5 k										
50 ns	1.25 G	625			2.5 G	1.25 k										
20 ns	1.25 G	250			2.5 G	500										
10 ns	1.25 G	125			2.5 G	250										
5 ns	1.25 G	62.5			2.5 G	125										
2 ns	1.25 G	25			2.5 G	50										
1 ns	1.25 G	12.5		2.5 G	25											

Acquisition when you specify this record length is performed in single mode.

* On DLM2000s with the /M1(S) option, with this record length, interleave mode cannot be turned off.

 : Roll Mode

When the Record Length Is 125 M points

(This record length can be selected on DLM2000s with the /M2 or /M3 option)

Intpl: Interpolation Mode

Rep: Repetitive Sampling Mode

Settings Time/div	When High Resolution mode is off								When High Resolution mode is on							
	When Interleave mode is off*				When Interleave mode is on				When Interleave mode is off				When Interleave mode is on			
	Realtime		Intpl/Rep		Realtime		Intpl/Rep		Realtime		Intpl/Rep		Realtime		Intpl/Rep	
	Sample Rate (S/s)	Record Length (Points)	Sample Rate (S/s)	Record Length (Points)	Sample Rate (S/s)	Record Length (Points)	Sample Rate (S/s)	Record Length (Points)	Sample Rate (S/s)	Record Length (Points)	Sample Rate (S/s)	Record Length (Points)	Sample Rate (S/s)	Record Length (Points)	Sample Rate (S/s)	Record Length (Points)
500 s	25k	125M			25 k	125 M										
200 s	62.5k	125M			62.5 k	125 M										
100 s	125k	125M			125 k	125 M										
50 s	250k	125M			250 k	125 M										
20 s	625k	125M			625 k	125 M										
10 s	1.25M	125M			1.25 M	125 M										
5 s	2.5M	125M			2.5 M	125 M										
2 s	6.25M	125M			6.25 M	125 M										
1 s	12.5M	125M			12.5 M	125 M										
500 ms	25M	125M			25 M	125 M										
200 ms	62.5M	125M			62.5 M	125 M										
100 ms	125M	125M			125 M	125 M										
50 ms	250M	125M			250 M	125 M										
20 ms	625M	125M			625 M	125 M										
10 ms	1.25G	125M			1.25 G	125 M										
5 ms	1.25G	62.5M	Interpolation mode and repetitive sampling mode cannot be used when you specify this record length.		2.5 G	125 M	Interpolation mode and repetitive sampling mode cannot be used when you specify this record length.									
2 ms	1.25G	25M			2.5 G	50 M										
1 ms	1.25G	12.5M			2.5 G	25 M										
500 μs	1.25G	6.25M			2.5 G	12.5 M										
200 μs	1.25G	2.5M			2.5 G	5 M										
100 μs	1.25G	1.25M			2.5 G	2.5 M										
50 μs	1.25G	625k			2.5 G	1.25 M										
20 μs	1.25G	250k			2.5 G	500 k										
10 μs	1.25G	125k			2.5 G	250 k										
5 μs	1.25G	62.5k			2.5 G	125 k										
2 μs	1.25G	25k			2.5 G	50 k										
1 μs	1.25G	12.5k			2.5 G	25 k										
500 ns	1.25G	6.25k			2.5 G	12.5 k										
200 ns	1.25G	2.5k			2.5 G	5 k										
100 ns	1.25G	1.25k			2.5 G	2.5 k										
50 ns	1.25G	625			2.5 G	1.25 k										
20 ns	1.25G	250			2.5 G	500										
10 ns	1.25G	125			2.5 G	250										
5 ns	1.25G	62.5			2.5 G	125										
2 ns	1.25G	25			2.5 G	50										
1 ns	1.25G	12.5			2.5 G	25										

When you specify this record length, high resolution mode cannot be turned on.

Acquisition when you specify this record length is performed in single mode.

* On DLM2000s with the /M2 option, with this record length, interleave mode cannot be turned off.

 : Roll Mode

Appendix 1 Relationship between the Time Axis Setting, Record Length, and Sample Rate

When the Record Length Is 250 M points

(This record length can be selected on DLM2000s with the /M3 option)

Intpl: Interpolation Mode

Rep: Repetitive Sampling Mode

Settings Time/div	When High Resolution mode is off								When High Resolution mode is on							
	When Interleave mode is off				When Interleave mode is on				When Interleave mode is off				When Interleave mode is on			
	Realtime		Intpl/Rep		Realtime		Intpl/Rep		Realtime		Intpl/Rep		Realtime		Intpl/Rep	
	Sample Rate (S/s)	Record Length (Points)	Sample Rate (S/s)	Record Length (Points)	Sample Rate (S/s)	Record Length (Points)	Sample Rate (S/s)	Record Length (Points)	Sample Rate (S/s)	Record Length (Points)	Sample Rate (S/s)	Record Length (Points)	Sample Rate (S/s)	Record Length (Points)	Sample Rate (S/s)	Record Length (Points)
500s					50k	250M										
200s					125k	250M										
100s					250k	250M										
50s					500k	250M										
20s					1.25M	250M										
10s					2.5M	250M										
5s					5M	250M										
2s					12.5M	250M										
1s					25M	250M										
500ms					25M	125M										
200ms					125M	250M										
100ms					250M	250M										
50ms					250M	125M										
20ms					1.25G	250M										
10ms					1.25G	125M										
5ms					2.5G	125M										
2ms					2.5G	50M										
1ms					2.5G	25M										
500µs					2.5G	12.5M										
200µs					2.5G	5M										
100µs					2.5G	2.5M										
50µs					2.5G	1.25M										
20µs					2.5G	500k										
10µs					2.5G	250k										
5µs					2.5G	125k										
2µs					2.5G	50k										
1µs					2.5G	25k										
500ns					2.5G	12.5k										
200ns					2.5G	5k										
100ns					2.5G	2.5k										
50ns					2.5G	1.25k										
20ns					2.5G	500										
10ns					2.5G	250										
5ns					2.5G	125										
2ns					2.5G	50										
1ns					2.5G	25										

When you specify this record length, interleave mode cannot be turned off.

Interpolation mode and repetitive sampling mode cannot be used when you specify this record length.

When you specify this record length, high resolution mode cannot be turned on.

Acquisition when you specify this record length is performed in single mode.

 : Roll Mode