

**EJX910A and EJX930A
Multivariable Transmitter
HART Communication Type**

IM 01C25R02-01E



EJX910A and EJX930A

Multivariable Transmitter

HART Communication Type

IM 01C25R02-01E 9th Edition

Contents

| | | |
|-----------|---|-------------|
| 1. | Introduction..... | 1-1 |
| ■ | Regarding This Manual | 1-1 |
| 1.1 | Safe Use of This Product | 1-2 |
| 1.2 | Warranty..... | 1-2 |
| 2. | Connection..... | 2-1 |
| 2.1 | Integral Indicator Display When Powering On | 2-1 |
| 2.2 | HART Protocol Revision | 2-2 |
| 2.3 | Device Description (DD) on a Configuration Tool and Transmitter Device Revision..... | 2-2 |
| 2.4 | Set the parameters using DTM | 2-3 |
| 2.5 | Interconnection Between DPharp and the HART Configuration Tool | 2-4 |
| 2.6 | Power Supply Voltage and Load Resistance..... | 2-4 |
| 3. | Parameter Setting..... | 3-1 |
| 3.1 | Menu Tree | 3-1 |
| 3.2 | Basic Setup..... | 3-16 |
| 3.2.1 | Tag and Device Information | 3-16 |
| 3.2.2 | Process Variable Setup..... | 3-16 |
| 3.2.3 | Measuring Range | 3-17 |
| 3.2.4 | Units | 3-18 |
| 3.2.5 | Damping Time Constant Setup..... | 3-18 |
| 3.2.6 | Differential Pressure Signal Low Cut Mode Setup | 3-19 |
| 3.2.7 | Impulse Line Connection Orientation Setup..... | 3-19 |
| 3.3 | Detailed Setup | 3-20 |
| 3.3.1 | Analog Output Signal Adjustable Range | 3-20 |
| 3.3.2 | Static Pressure Setup | 3-20 |
| 3.3.3 | External Temperature Fixation Mode..... | 3-20 |
| 3.3.4 | Integral Indicator Scale Setup..... | 3-21 |
| 3.3.5 | Total Flow Setup..... | 3-23 |
| 3.3.6 | Sensor Trim..... | 3-24 |
| 3.3.7 | Trim Analog Output | 3-25 |
| 3.3.8 | External Switch Mode | 3-26 |

| | | |
|-----------|--|-------------|
| 3.3.9 | CPU Failure Burnout Direction and Hardware Write Protect | 3-26 |
| 3.3.10 | Software Write Protection | 3-27 |
| 3.3.11 | Alarm | 3-27 |
| 3.3.12 | Status Output and Pulse Output | 3-28 |
| 3.3.13 | Test Output, Simulation, and Squawk | 3-30 |
| 3.3.14 | Basic Flow Calculation (Basic mode) | 3-33 |
| 3.3.15 | Burst Mode | 3-36 |
| 3.3.15.1 | In the case of using HART 5 | 3-36 |
| 3.3.15.2 | In the case of using HART 7 | 3-36 |
| 3.3.16 | Multidrop Mode | 3-41 |
| 3.3.16.1 | In the case of using HART 5 | 3-41 |
| 3.3.16.2 | In the case of using HART 7 | 3-42 |
| 3.3.17 | Switching HART Protocol Revision | 3-42 |
| 4. | Diagnostics | 4-1 |
| 4.1 | Self-Diagnostics | 4-1 |
| 4.1.1 | Identify Problems by Using the HART Configuration Tool | 4-1 |
| 4.1.2 | Checking with Integral Indicator | 4-2 |
| 4.1.3 | Status information available for HART 7 | 4-2 |
| 4.2 | Advanced Diagnostics | 4-3 |
| 4.2.1 | Multi-sensing Process Monitoring | 4-3 |
| 4.2.2 | Impulse Line Blockage Detection (ILBD) | 4-3 |
| 4.2.2.1 | Blockage Detection | 4-6 |
| 4.2.2.2 | Combination of Reference Result and Blockage Detection | 4-8 |
| 4.2.2.3 | Operation Parameters | 4-9 |
| 4.2.2.4 | Operating Procedure | 4-11 |
| 4.2.2.5 | Alarm and Alert Setting | 4-12 |
| 4.2.2.6 | Condition Check | 4-14 |
| 4.2.2.7 | Obtain Reference Values | 4-15 |
| 4.2.2.8 | Capability Test of Blockage Detection Operation | 4-16 |
| 4.2.2.9 | Start ILBD Operation | 4-16 |
| 4.2.2.10 | Tuning | 4-17 |
| 4.2.2.11 | Reset of Reference Value | 4-18 |
| 4.2.2.12 | ILBD Parameter List | 4-19 |
| 4.2.3 | Heat Trace Monitoring | 4-21 |
| 4.2.3.1 | Flg Temp Coef Setting | 4-21 |
| 4.2.3.2 | Out of Temperature Measurement Range | 4-22 |
| 4.2.3.3 | Parameter Lists for Heat Trace Monitoring | 4-22 |
| 4.3 | Alarms and Countermeasures | 4-23 |
| 5. | Parameter Summary | 5-1 |
| 6. | Procedures to Call Parameter | 6-1 |

| | | |
|--------------------|---|--------------|
| Appendix 1. | Safety Instrumented Systems Installation | A1-1 |
| A1.1 | Scope and Purpose | A1-1 |
| A1.2 | Using the EJX for an SIS Application | A1-1 |
| A1.2.1 | Safety Accuracy | A1-1 |
| A1.2.2 | Diagnostic Response Time | A1-1 |
| A1.2.3 | Setup | A1-1 |
| A1.2.4 | Required Parameter Settings | A1-2 |
| A1.2.5 | Proof Testing | A1-2 |
| A1.2.6 | Repair and Replacement | A1-3 |
| A1.2.7 | Startup Time | A1-3 |
| A1.2.8 | Firmware Update | A1-3 |
| A1.2.9 | Reliability Data | A1-3 |
| A1.2.10 | Lifetime Limits | A1-4 |
| A1.2.11 | Environmental Limits | A1-4 |
| A1.2.12 | Application Limits | A1-4 |
| A1.3 | Definitions and Abbreviations | A1-4 |
| A1.3.1 | Definitions | A1-4 |
| A1.3.2 | Abbreviations | A1-4 |
| Appendix 2. | ILBD Check List..... | A2-1 |
| Appendix 3. | Menu Tree for Previous Version | A3-1 |
| A3.1 | Menu Tree (Device revision 10 or earlier)..... | A3-1 |
| A3.1.1 | For DD (HART 5/HART 7) and DTM (HART 7) | A3-1 |
| A3.1.2 | For DTM (HART 5)..... | A3-9 |
| A3.2 | Menu Tree (Device revision 11) | A3-13 |
| A3.2.1 | For DD (HART 7) and DTM (HART 7) | A3-13 |

Revision Information

1. Introduction

Thank you for purchasing the DPharp EJX multivariable transmitter.

EJX multivariable transmitters are precisely calibrated at the factory before shipment.

To ensure both safety and efficiency, please read this manual carefully before operating the instrument.

This manual describes the HART protocol communication functions of the EJX multivariable transmitter and explains how to set the parameters for EJX multivariable transmitters using the HART configuration tool.

For information on the installation, wiring, and maintenance of EJX multivariable transmitters, please refer to the user's manual.

For information on the flow setup of EJX multivariable transmitters, please refer to the user's manual and FSA120 FlowNavigator on-line manual.

| | |
|---|-----------------|
| EJX910A / EJX930A | IM 01C25R01-01E |
| FSA111 FieldMate Versatile Device Management Wizard | IM 01R01A01-01E |
| FSA120 FlowNavigator | IM 01C25R51-01E |

WARNING

When using the EJX in a Safety Instrumented Systems (SIS) application, refer to Appendix 1 in this manual. The instructions and procedures in the appendix must be strictly followed in order to maintain the designed safety integrity of the transmitter.

■ Regarding This Manual

- This manual should be provided to the end user.
- The contents of this manual are subject to change without prior notice.
- All rights reserved. No part of this manual may be reproduced in any form without Yokogawa's written permission.
- Yokogawa makes no warranty of any kind with regard to this manual, including, but not limited to, implied warranty of merchantability and fitness for a particular purpose.

- If any question arises or errors are found, or if any information is missing from this manual, please inform the nearest Yokogawa sales office.
- The specifications covered by this manual are limited to those for the standard type under the specified model number break-down and do not cover custom-made instruments.
- Please note that changes in the specifications, construction, or component parts of the instrument may not immediately be reflected in this manual at the time of change, provided that postponement of revisions will not cause difficulty to the user from a functional or performance standpoint.
- The following safety symbols are used in this manual:

WARNING

Indicates a potentially hazardous situation which, if not avoided, could result in death or serious injury.

CAUTION

Indicates a potentially hazardous situation which, if not avoided, may result in minor or moderate injury. It may also be used to alert against unsafe practices.

IMPORTANT

Indicates that operating the hardware or software in this manner may damage it or lead to system failure.

NOTE

Draws attention to information essential for understanding the operation and features.

1.1 Safe Use of This Product

For the safety of the operator and to protect the instrument and the system, please be sure to follow this manual's safety instructions when handling this instrument. If these instructions are not heeded, the protection provided by this instrument may be impaired. In this case, Yokogawa cannot guarantee that the instrument can be safely operated. Please pay special attention to the following points:

(a) Installation

- This instrument may only be installed by an engineer or technician who has an expert knowledge of this device. Operators are not allowed to carry out installation unless they meet this condition.
- With high process temperatures, care must be taken not to burn yourself by touching the instrument or its casing.
- Never loosen the process connector nuts when the instrument is installed in a process. This can lead to a sudden, explosive release of process fluids.
- When draining condensate from the pressure detector section, take appropriate precautions to prevent the inhalation of harmful vapors and the contact of toxic process fluids with the skin or eyes.
- When removing the instrument from a hazardous process, avoid contact with the process fluid and the interior of the meter.
- All installation shall comply with local installation requirements and the local electrical code.

(b) Wiring

- The instrument must be installed by an engineer or technician who has an expert knowledge of this instrument. Operators are not permitted to carry out wiring unless they meet this condition.
- Before connecting the power cables, please confirm that there is no current flowing through the cables and that the power supply to the instrument is switched off.

(c) Operation

- Wait 10 min. after the power is turned off before opening the covers.

(d) Maintenance

- Please carry out only the maintenance procedures described in this manual. If you require further assistance, please contact the nearest Yokogawa office.
- Care should be taken to prevent the build up of dust or other materials on the display glass and the name plate. To clean these surfaces, use a soft, dry cloth.

(e) Modification

- Yokogawa will not be liable for malfunctions or damage resulting from any modification made to this instrument by the customer.

1.2 Warranty

- The warranty shall cover the period noted on the quotation presented to the purchaser at the time of purchase. Problems occurring during the warranty period shall basically be repaired free of charge.
- If any problems are experienced with this instrument, the customer should contact the Yokogawa representative from which this instrument was purchased or the nearest Yokogawa office.
- If a problem arises with this instrument, please inform us of the nature of the problem and the circumstances under which it developed, including the model specification and serial number. Any diagrams, data and other information you can include in your communication will also be helpful.
- The party responsible for the cost of fixing the problem shall be determined by Yokogawa following an investigation conducted by Yokogawa.
- The purchaser shall bear the responsibility for repair costs, even during the warranty period, if the malfunction is due to:
 - Improper and/or inadequate maintenance by the purchaser.
 - Malfunction or damage due to a failure to handle, use, or store the instrument in accordance with the design specifications.
 - Use of the product in question in a location not conforming to the standards specified by Yokogawa, or due to improper maintenance of the installation location.
 - Failure or damage due to modification or repair by any party except Yokogawa or an approved representative of Yokogawa.
 - Malfunction or damage from improper relocation of the product in question after delivery.
 - Reason of force majeure such as fires, earthquakes, storms/floods, thunder/lightening, or other natural disasters, or disturbances, riots, warfare, or radioactive contamination.

2. Connection

2.1 Integral Indicator Display When Powering On

For models with the integral indicator code “D”, the display shows all segments in the LCD and then changes to the displays shown below sequentially.

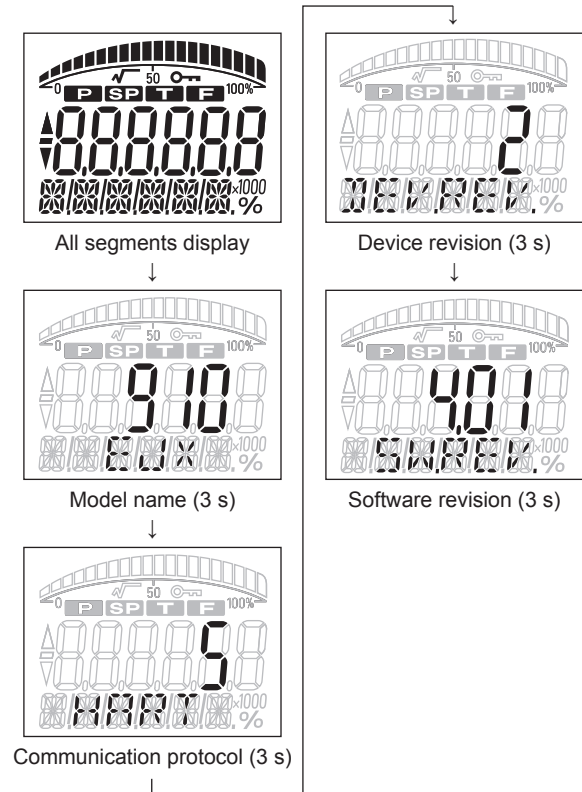

F0200.ai

Either “5” or “7” is displayed on the communication protocol display as HART protocol revision followed by device revision number on the device revision display.



NOTE

For output signal code “-E”, this function is available for software revision 3.01 or later. Software revision can be checked by the following procedure.

[Root Menu](Refer to section 3.1) → Review → Software rev

In case of EJX910 V2.1 (HART 5 DTM)
Configuration → Device information1 → Software rev



NOTE

In this User’s Manual, HART protocol revision 5 and 7 are described as HART 5 and HART 7 respectively.



NOTE

LCD display can be set to all segments display only.

• Procedure to call up the display

[Root Menu] (Refer to section 3.1) → Detailed setup → Display condition → Power on info/Chg power on info

In case of EJX910 V2.1 (HART 5 DTM)
Configuration → Local Display → Chg power on info

| | |
|-----|--|
| On | Show all segments display, Model name, Communication Protocol, and Device Revision when powering on. |
| Off | Show all segments display when powering on. |

2.2 HART Protocol Revision

For the models with the output signal code “-J”, HART protocol revision 5 or 7 is selectable. The protocol revision is set as specified in the order.

The typical function which is available by HART protocol revision 7 is listed as follows. Refer to HART 7 description in this document or **HART 7** mark for detail.

- Long Tag Supporting Up to 32 Characters
Long tag secures a better asset management with abundant digits in its software.
- Enhanced Burst Mode and Event Notification
Advanced burst mode includes the variety of transmission setting by specifying burst variables, update period, and message trigger mode, and event notification function gives you alert signal based on the status change in preset values and self-diagnosis.
- Squawk
Identifying the transmitter by displaying the particular pattern on LCD
- Multidrop Communication
Up to 63 transmitters can be connected. An analog signal output available for one device in a loop.

How to confirm protocol revision is shown below.

There are three ways to confirm the protocol revision set to the transmitter.

- (1) Confirmation by the name plate
The HART protocol revision is shown by the last number of the serial number.
Refer to Figure 2.1.

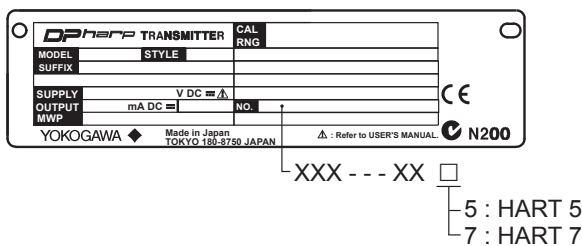

Figure 2.1 Name Plate

- (2) Confirmation by using integral indicator (When the integral indicator code is “D”)
Refer to section 2.1.

- (3) Confirmation by using HART configuration tool
Follow the procedure below.
 - 1) Connect the configuration tool to the transmitter.
 - 2) Select the “Root Menu” (Refer to section 3.1)
Call up the “Review” display.
The procedures described in ‘3.3.17 (5) b’ is also available.
 - 3) HART protocol revision is displayed on the “Universal rev” column.



IMPORTANT

Protocol revision supported by HART configuration tool must be the same or higher than that of the EJX multivariable transmitter.

| | | Protocol revision supported by HART configuration tool | |
|--|---|--|---|
| | | 5 | 7 |
| Protocol revision of EJX multivariable transmitter | 5 | ○ | ○ |
| | 7 | × | ○ |

- : Communication OK
- × : Communication NG



NOTE

HART 7 communication is supported by FieldMate R2.02 or later.



NOTE

When the output signal code of EJX multivariable transmitter is “-J”, HART protocol revision can be changed. Refer to subsection 3.3.17 about the procedure of the revision change of HART 5 and HART 7.

2.3 Device Description (DD) on a Configuration Tool and Transmitter Device Revision

Before using a HART configuration tool, confirm that the DD for the transmitter is installed in the configuration tool.

About the DD, use the device type, device revision and DD Revision shown in the Table 2.1.

Table 2.1 HART Protocol Revision, Device Revision and DD Revision

| HART Protocol Revision (*1) | EJX Multivariable Transmitter | | | | |
|-----------------------------|-------------------------------|--------------------|-----------------|-------------|---|
| | Model Name | Device Type | Device Revision | DD Revision | Elements Configurable in the Auto Compensation Mode |
| 5 | EJX910A EJX930A | EJX-MV (0x54) | 2 | 2 or later | Orifice, Venturi and Nozzle |
| 7 | EJX910A EJX930A | EJX-MV (0x3754) | 10 | 1 or later | Orifice, Venturi and Nozzle |
| 7 | EJX910A EJX930A | EJX-MV (0x3754) | 11 | 1 or later | Orifice, Venturi, Nozzle, Multiport Averaging Pitot and Cone meters |
| | | | 12 | | |

*1: When the output signal code is “-E”, only “5” is available.

The device revision of the transmitter and DD can be confirmed as shown below.

If the correct DD is not installed in the configuration tool, download it from the official web site of Field Comm Group.

(1) Confirming the device revision of the transmitter

- Confirmation by using integral indicator (When the integral indicator code is “D”) Refer to the section 2.1
- Confirmation by using HART configuration tool

Follow the procedure below.

- 1) Connect the configuration tool to the transmitter.
- 2) Select the “Root Menu” (Refer to section 3.1)
Call up the “Review” display.
- 3) The device revision is displayed on the “Fld dev rev” column.

(2) Confirming the device revision of the configuration tool

Confirm the device revision from the installed DD file name according to the procedure provided for the configuration tool.

The first two digits indicate the device revision and the next two digits indicate the DD revision.



NOTE

Device revision of DD file is given in hexadecimal



NOTE

In this user’s manual, Device Revision is described as “Dev.Rev.”.

For example, Device Revision 11 is “Dev. Rev.11”

2.4 Set the parameters using DTM

When configure the parameters using FieldMate, use the DTM (Device Type Manager) shown in the Table 2.2.

Table 2.2 HART Protocol Revision and DTM

| HART Protocol Revision | DTM | | EJX multivariable transmitters | | |
|------------------------|--------------------------|--------------------|--------------------------------|----------------------|-----------------|
| | Name | Revision | Model Name | Device Type | Device Revision |
| 5 | EJX910 FDT2.0 HART DTM | 5.7.2.0*1 or later | EJX910A EJX930A | EJX910 (0x54) | 2 |
| 7 | EJX910 FDT2.0 HART 7 DTM | 5.7.2.0*1 or later | EJX910A EJX930A | EJX910_ EXP (0x3754) | 10 11 |
| | | 5.9.9.0*2 or later | | | 12 |

*1: The DTM corresponding to this revision is included in Yokogawa DTM Library 7.2/Device Files R3.03.00 (FieldMate).

*2: The DTM corresponding to this revision is included in Yokogawa DTM Library 8.9/Device Files R3.09.23 (FieldMate).



NOTE

The DTM revision can be confirmed by “DTM setup”.

Device Files is a Media included in FieldMate. The user registration site provides Device Files with the latest update programs.
 (URL: <https://partner.yokogawa.com/global/fieldmate/>)

In case update, following operation by “DTM setup” is required.

- Update DTM catalog
- Assign corresponding DTM to the device (refer to Table 2.2)

Refer to FieldMate Instruction Manual for detail.



NOTE

Previous DTM version:
 EJX910 V2.1
 EJX910 HART 7 DTM

Refer to Appendix 3.

2.5 Interconnection Between DPharp and the HART Configuration Tool

The HART configuration tool can interface with the transmitter from the control room, the transmitter site, or any other wiring termination point in the loop, provided there is a minimum of 250 Ω between the connection and the power supply. To communicate, it must be connected in parallel with the transmitter; the connections are non-polarized. Figure 2.2 illustrates the wiring connections for direct interface at the transmitter site for the DPharp. The HART configuration tool can be used for remote access from any terminal strip as well.

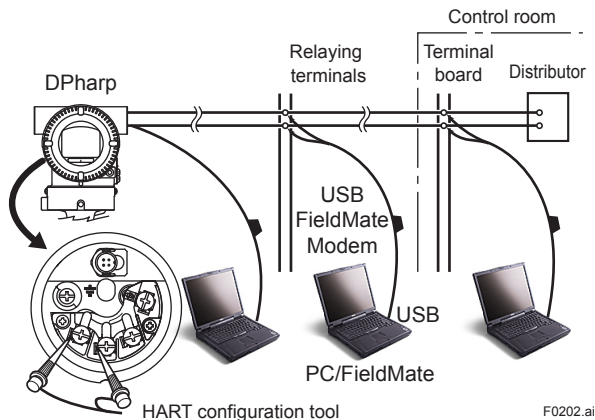

Figure 2.2 Connecting the HART Configuration Tool

2.6 Power Supply Voltage and Load Resistance

When configuring the loop, make sure that the external load resistance is within the range in the figure below.

(Note) With an intrinsically safe transmitter, external load resistance includes safety barrier resistance.

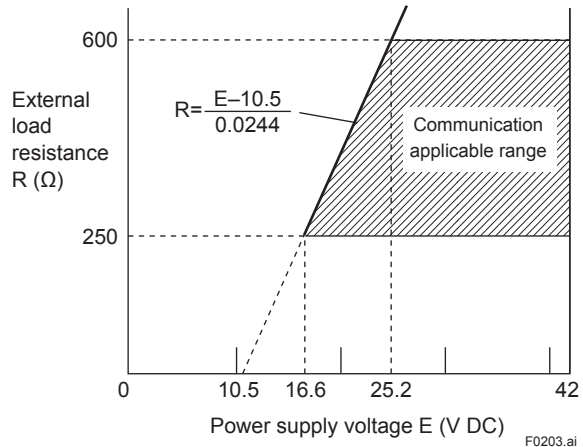

Figure 2.3 Relationship between Power Supply Voltage and External Load Resistance

3. Parameter Setting

3.1 Menu Tree

The menu tree is different in DD and DTM, and device revision respectively.

See the menu tree corresponding to the configuration tool.

Also, if you are using a device of the previous version or DTM Refer to Appendix 3.

| DTM/DD | HART | DTM Name | [Dev. Rev.] | Remarks | |
|--------|--------|----------------------------|-------------|---------------------------|--|
| DTM | HART 7 | EJX910 FDT2.0 HART 7 DTM | 12 | Default related DTM. | ⇒ Refer to this section. |
| | | | 11 | | ⇒ Refer to previous revision Appendix 3.2. |
| | | HART Built-in DTM (HART 7) | 12 | For 3rd vendar DTM Frame. | ⇒ Refer to this section. |
| | | | 11 | For 3rd vendar DTM Frame. | ⇒ Refer to previous revision Appendix 3.2. |
| | | EJX910 HART 7 DTM | 10 | For 3rd vendar DTM Frame. | ⇒ Refer to previous revision Appendix 3.1. |
| DD | HART 7 | --- | 12 | | ⇒ Refer to this section. |
| | | --- | 11 | | ⇒ Refer to previous revision Appendix 3.2. |
| | | --- | 10 | | ⇒ Refer to previous revision Appendix 3.1. |
| DTM | HART 5 | EJX910 FDT2.0 HART DTM | 2 | Default related DTM. | ⇒ Refer to this section. |
| | | EJX910 V2.1 | 2 | For 3rd vendar DTM Frame. | ⇒ Refer to previous revision Appendix 3.1. |
| | | EJX910 HART DTM | 2 | For 3rd vendar DTM Frame. | ⇒ Refer to previous revision Appendix 3.1. |
| | | HART Built-in DTM (HART 5) | 2 | For 3rd vendar DTM Frame. | ⇒ Refer to previous revision Appendix 3.1. |
| DD | HART 5 | --- | 2 | | ⇒ Refer to previous revision Appendix 3.1. |

■ DD (HART 7)

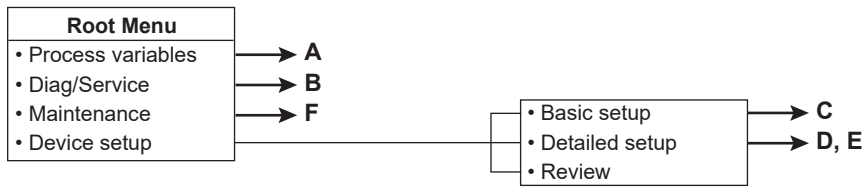

■ EJX910 FDT2.0 HART DTM (HART 5)

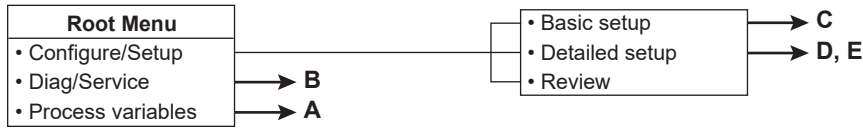

■ EJX910 FDT2.0 HART 7 DTM

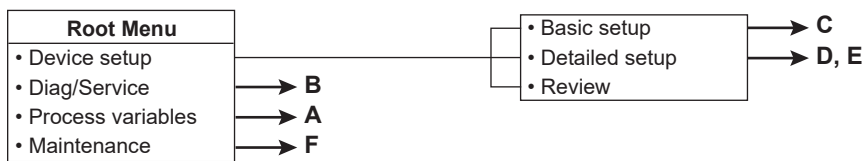

■ HART Built-in DTM (HART 7)

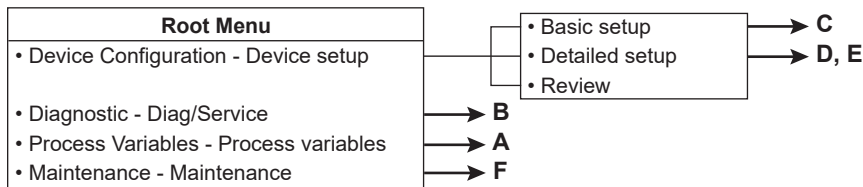

F0301-01.ai

A

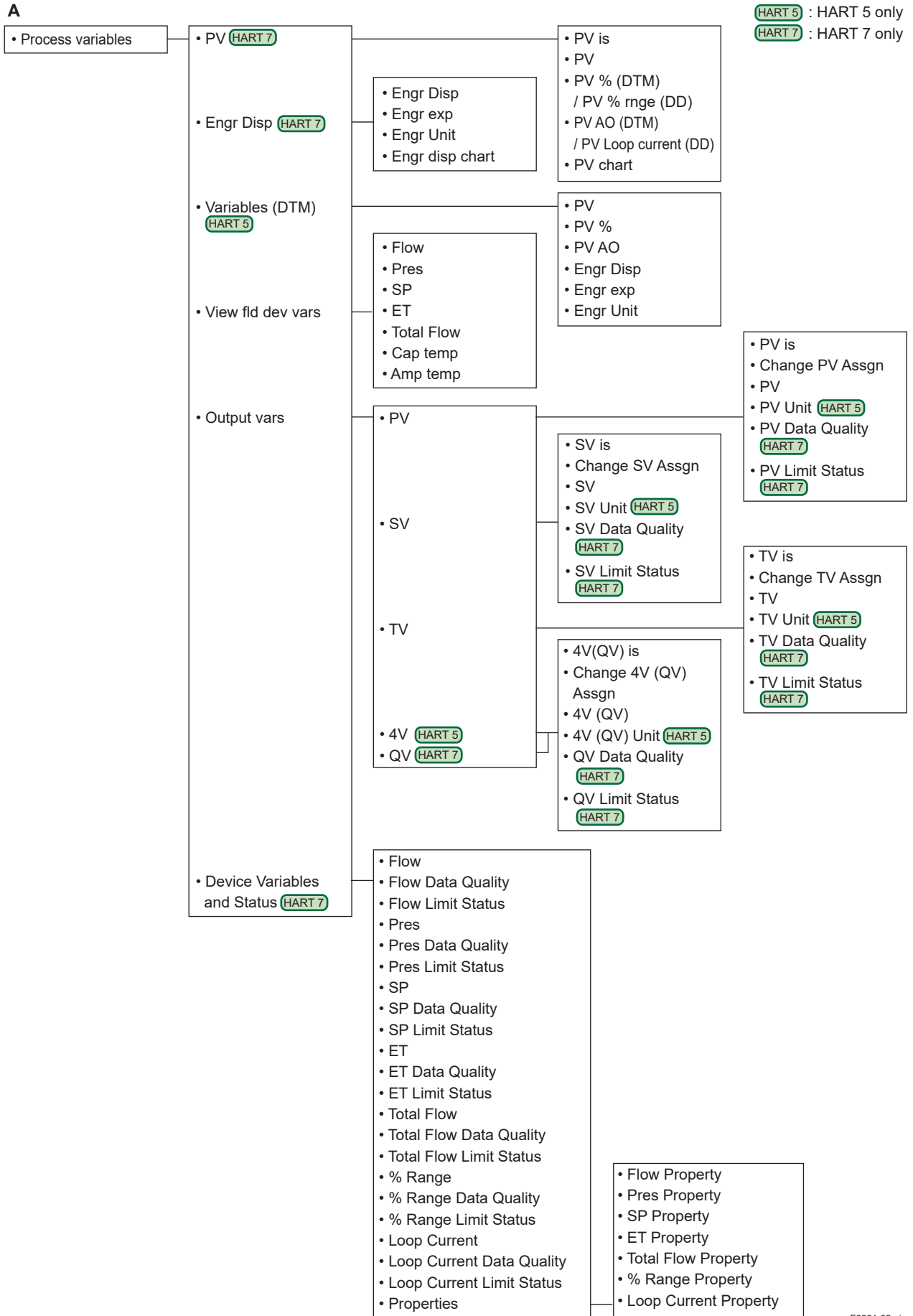

(HART 5) : HART 5 only

(HART 7) : HART 7 only

B

HART 5 : HART 5 only
HART 7 : HART 7 only

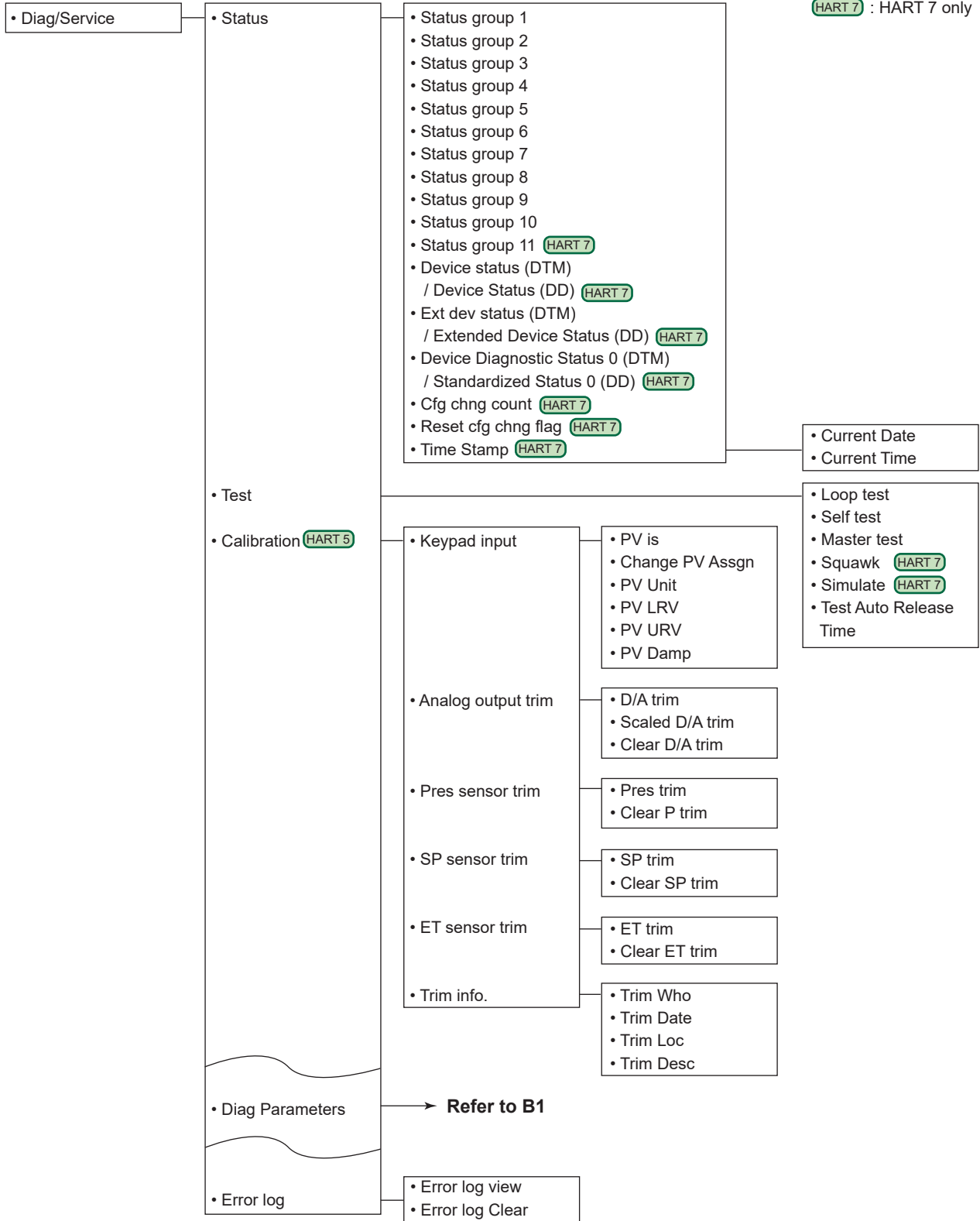

F0301-03.ai

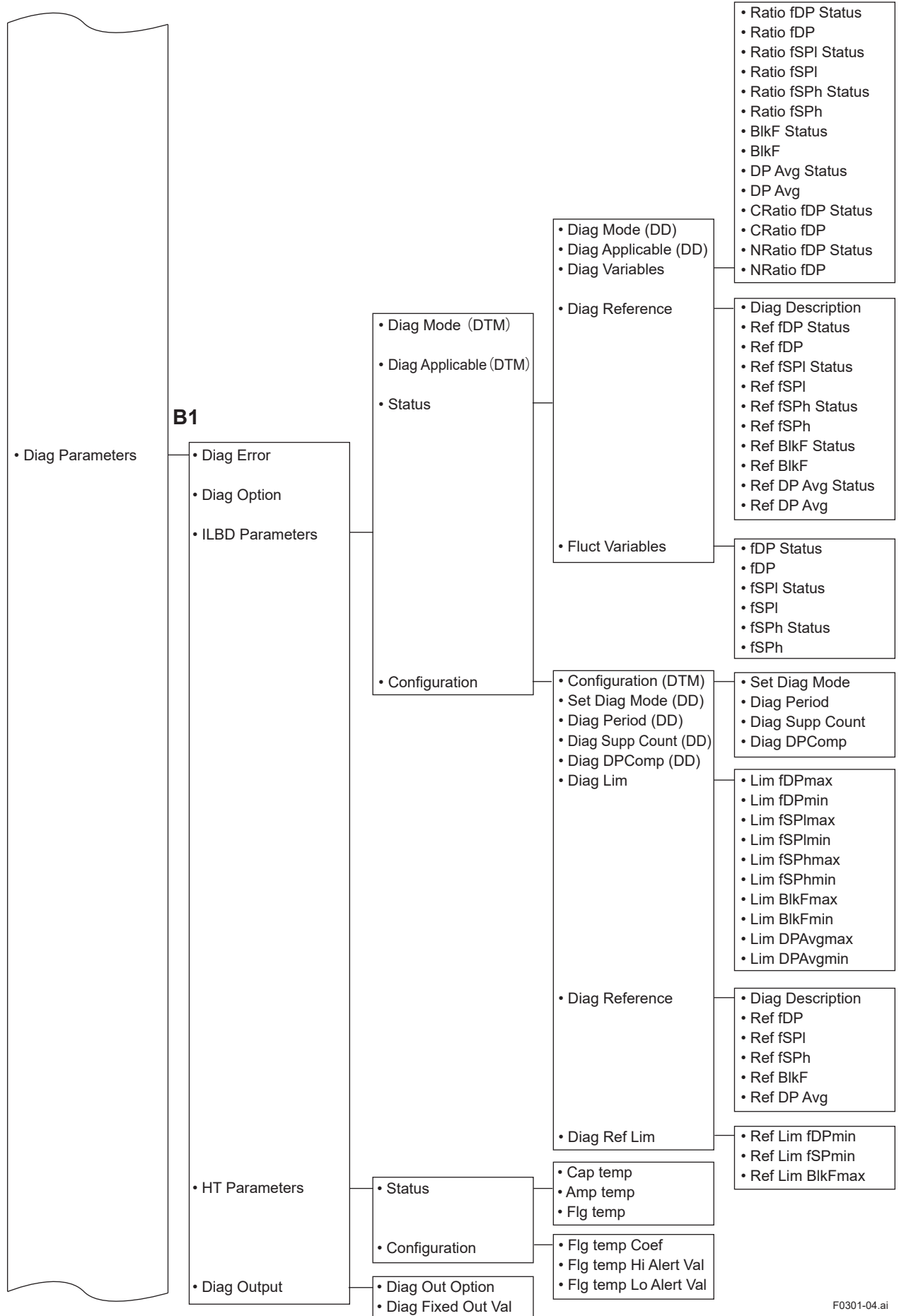

F0301-04.ai

C

EJX910 FDT2.0 HART DTM (HART 5)

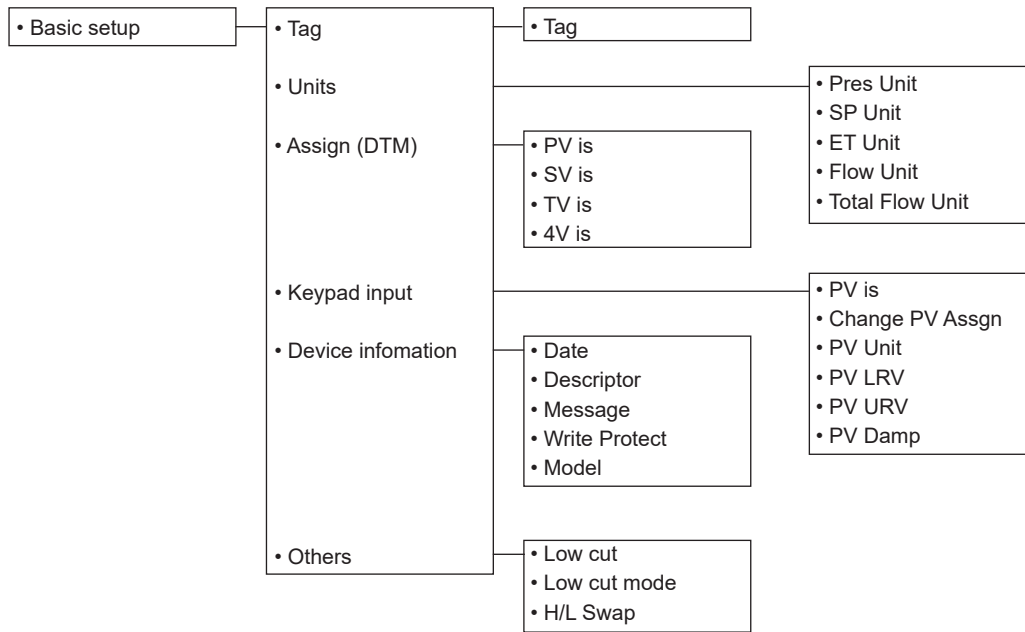

DD (HART 7)
EJX910 FDT2.0 HART 7 DTM
HART Built-in DTM (HART 7)

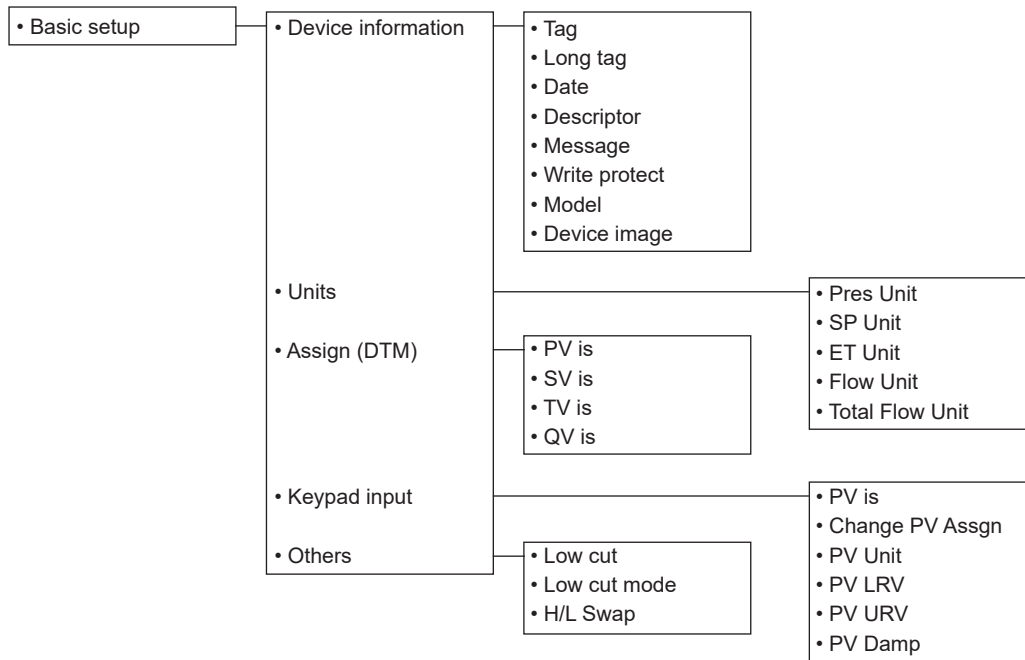

F0301-05.ai

D

HART 7 : HART 7 only

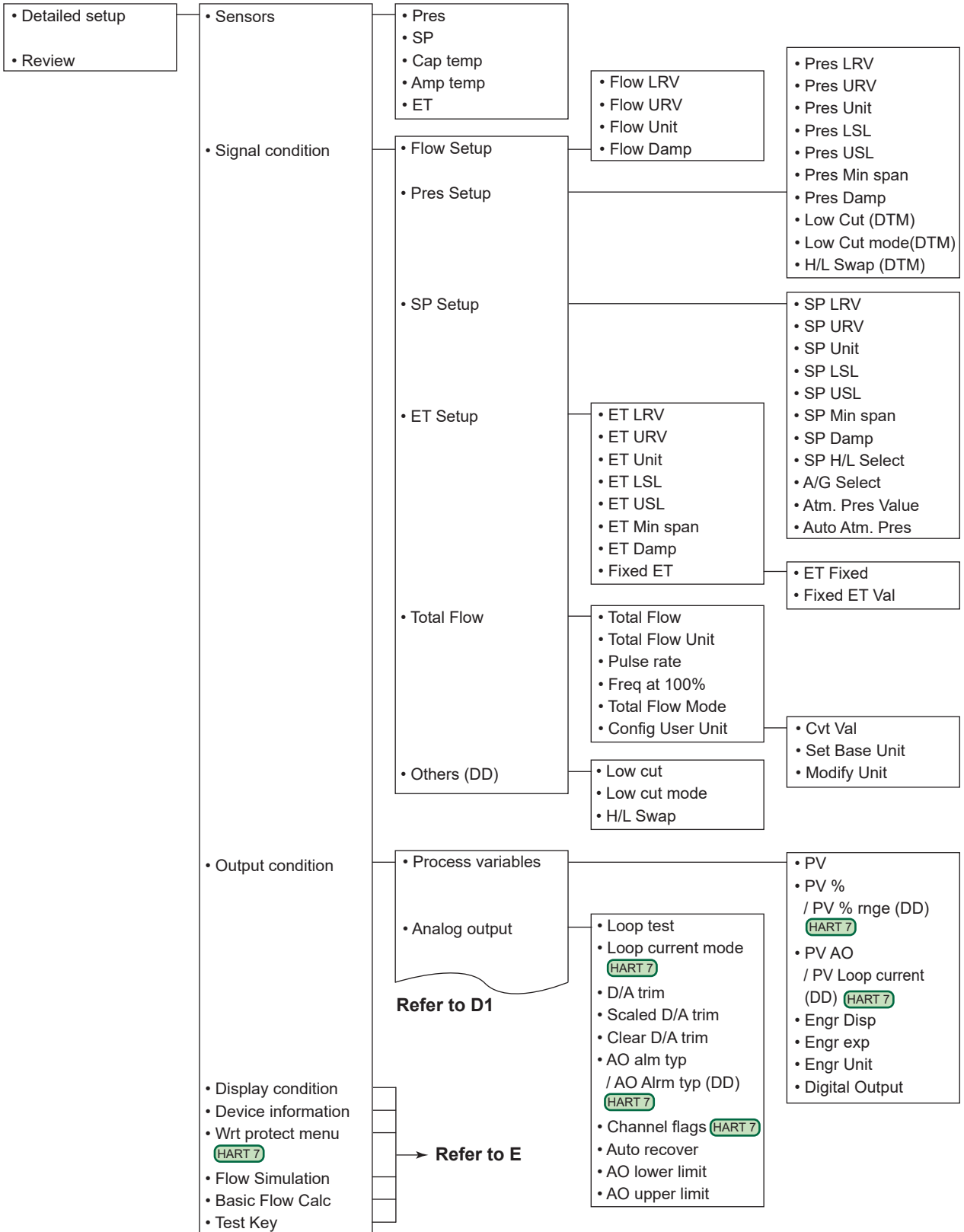

F0301-06.ai

D1

EJX910 FDT2.0 HART DTM (HART 5)

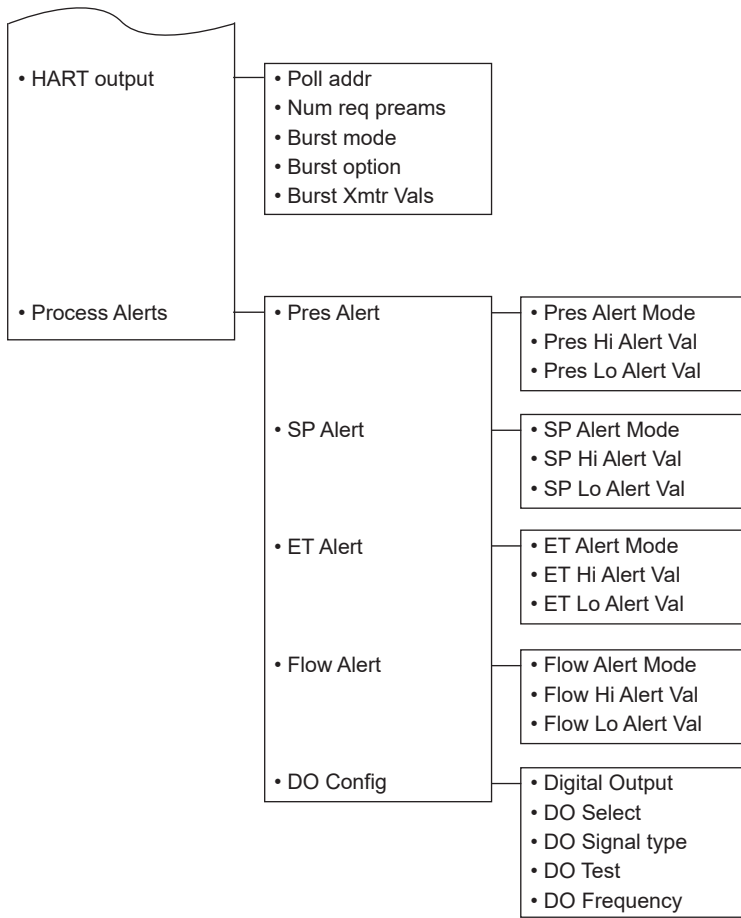

F0301-07.ai

D1

DD (HART 7)
EJX910 FDT2.0 HART 7 DTM
HART Built-in DTM (HART 7)

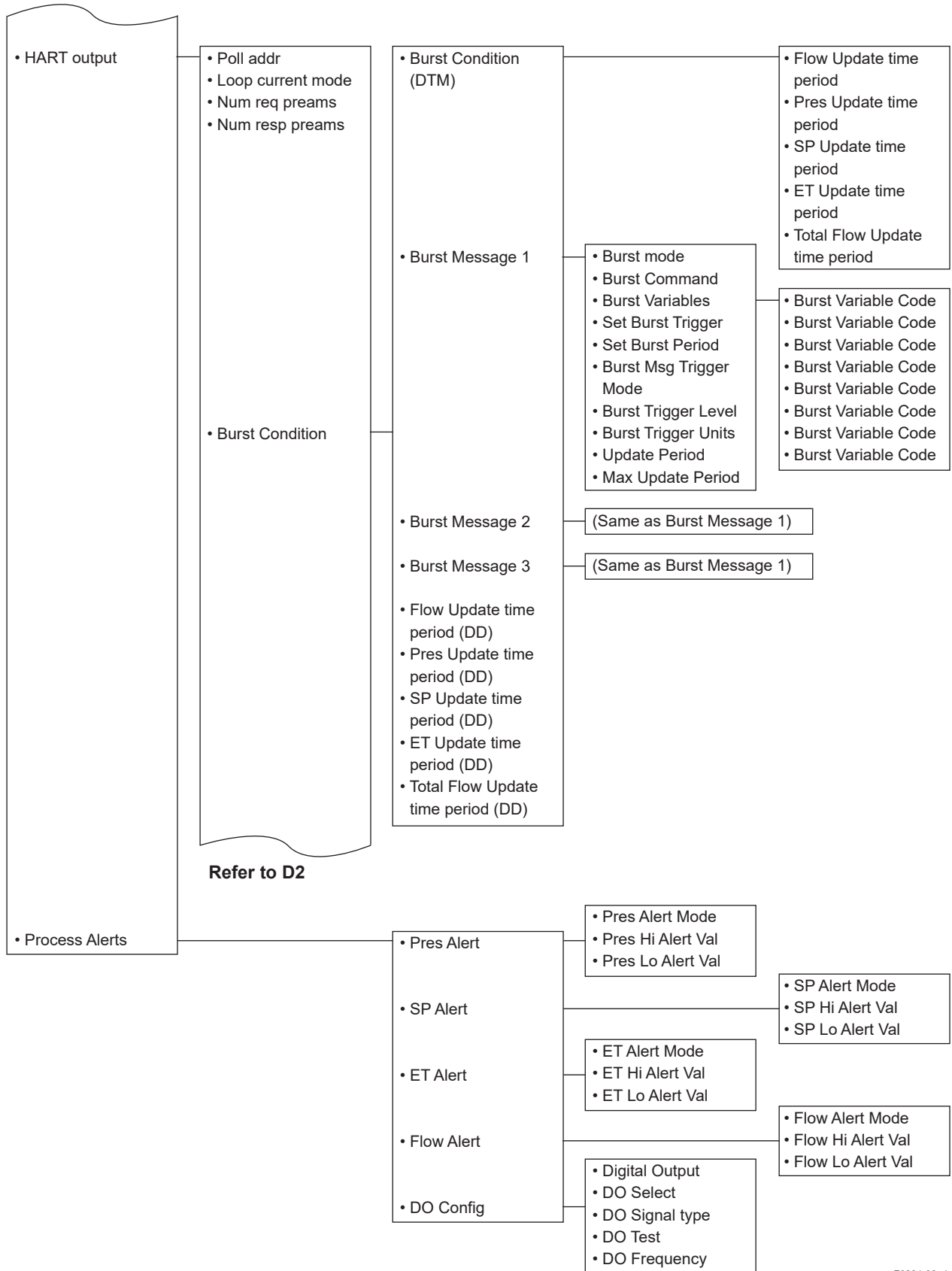

Refer to D2

F0301-08.ai

D2

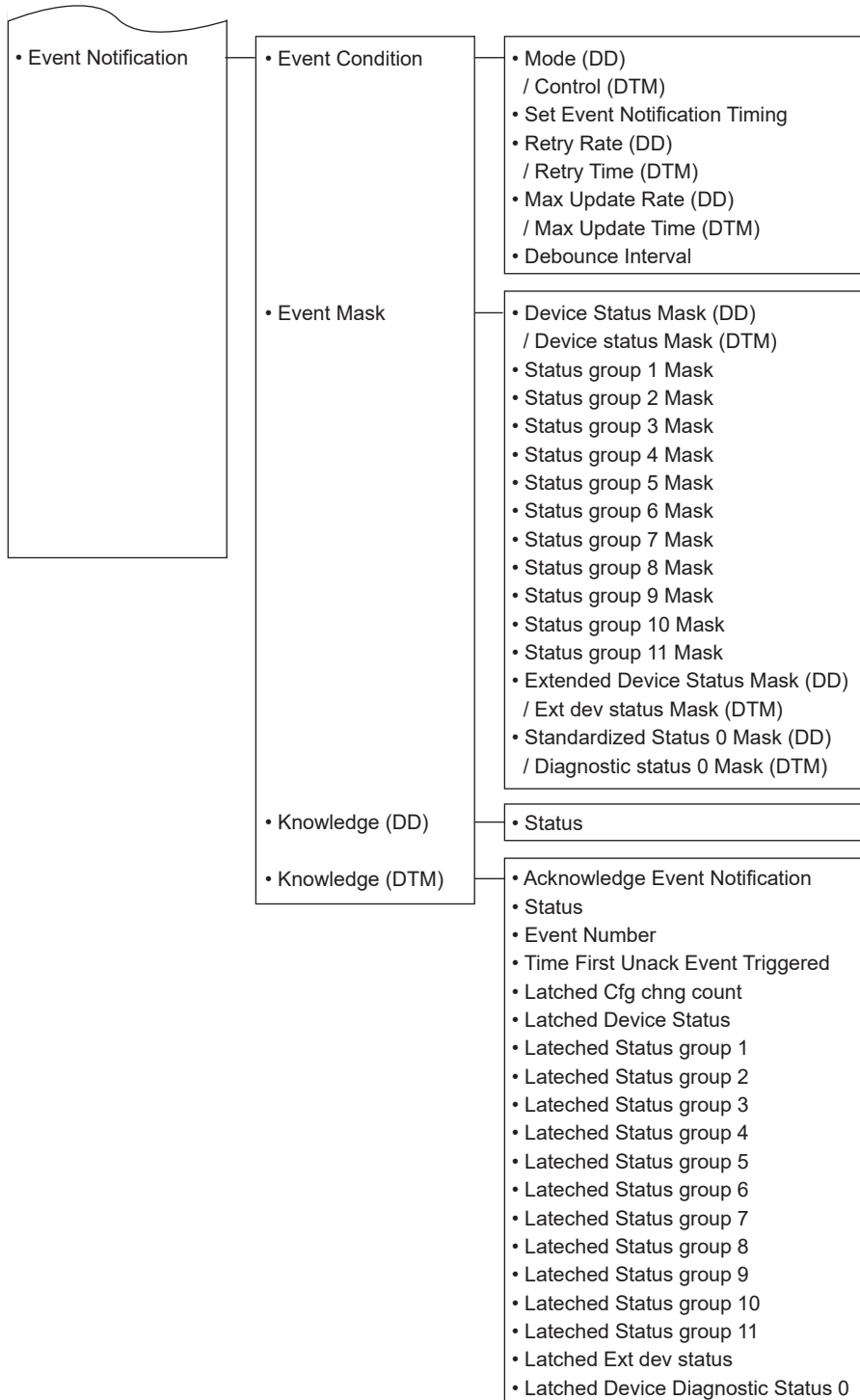

F0301-09.ai

E

EJX910 FDT2.0 HART DTM (HART 5)

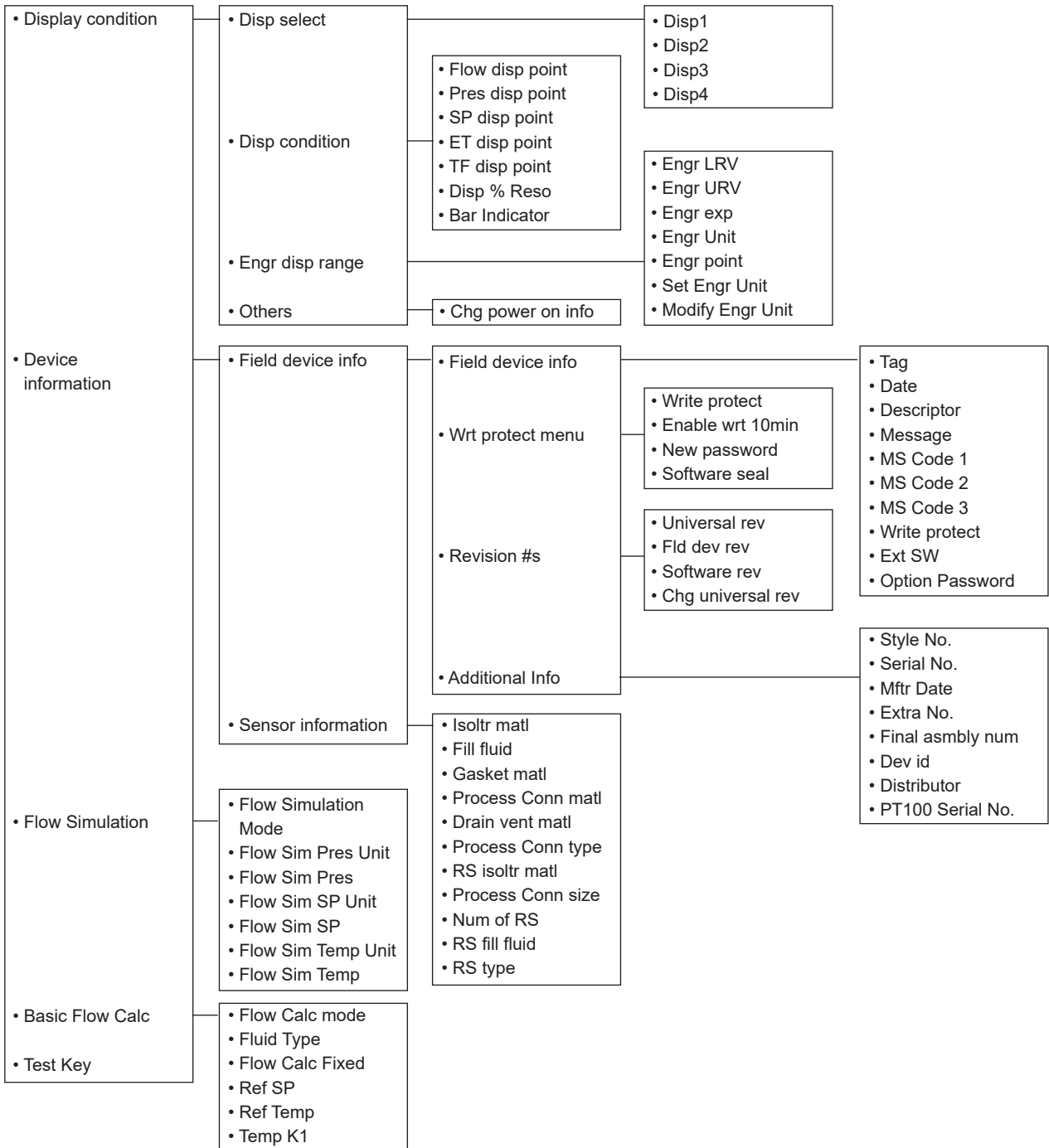

F0301-10.ai

E

DD (HART 7)
 EJX910 FDT2.0 HART 7 DTM
 HART Built-in DTM (HART 7)

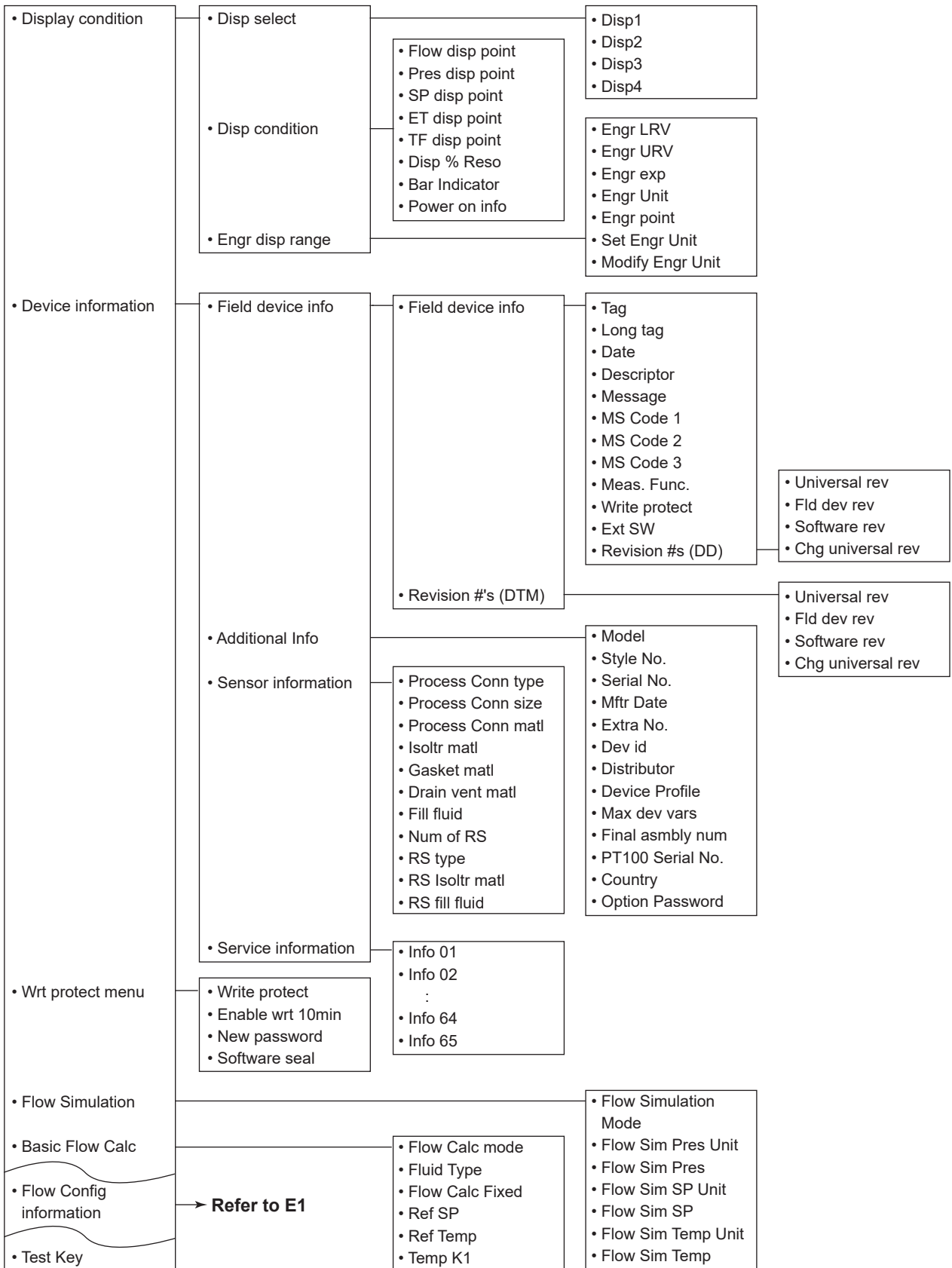

F0301-11.ai

E1

DD (HART 7)
 EJX910 FDT2.0 HART 7 DTM
 HART Built-in DTM (HART 7)

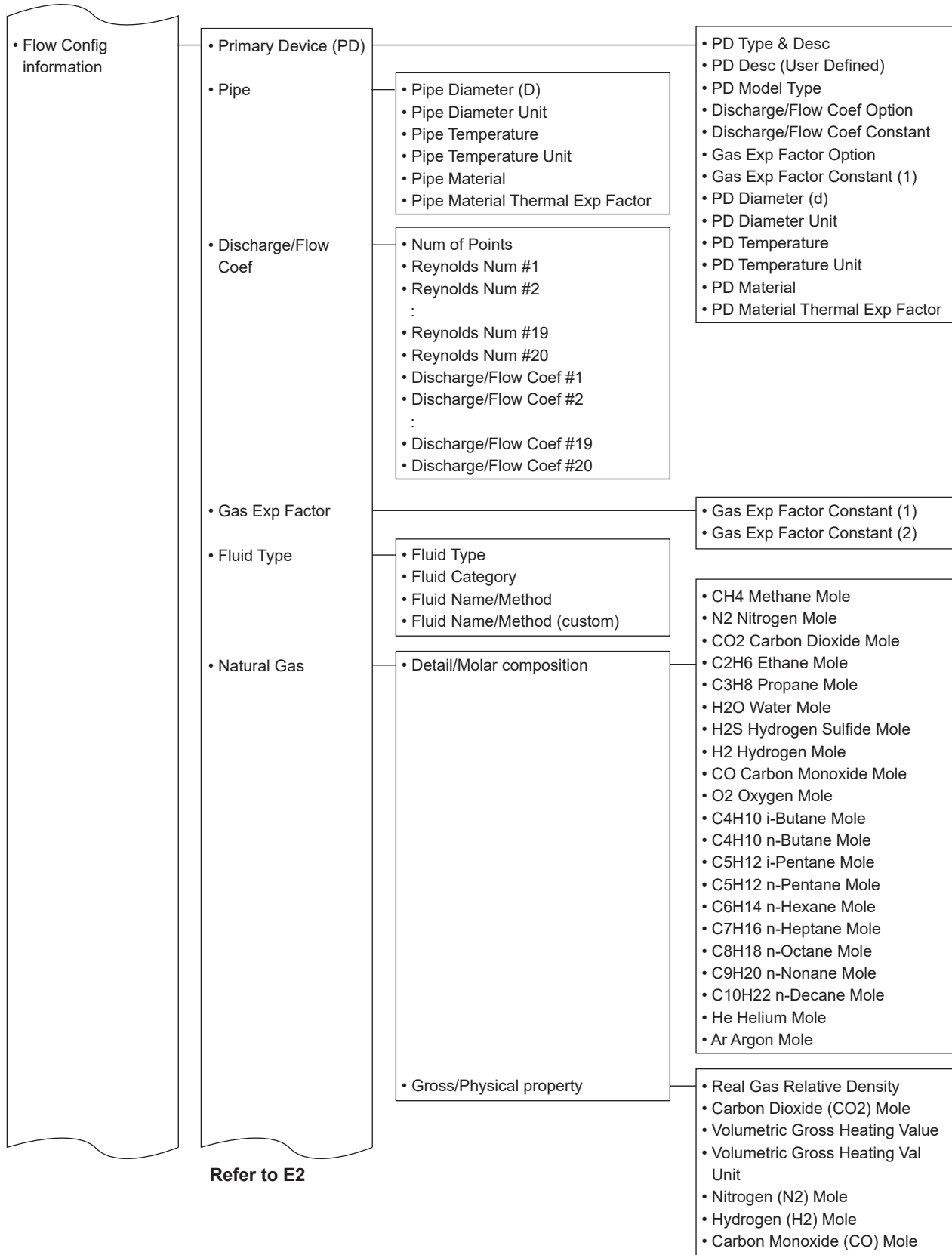

F0301-12.ai

E2

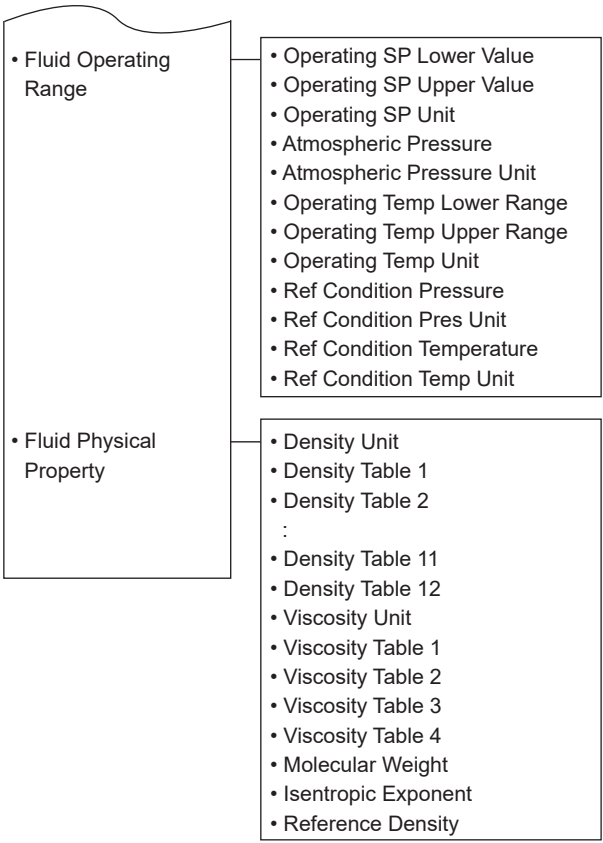

F0301-13.ai

F

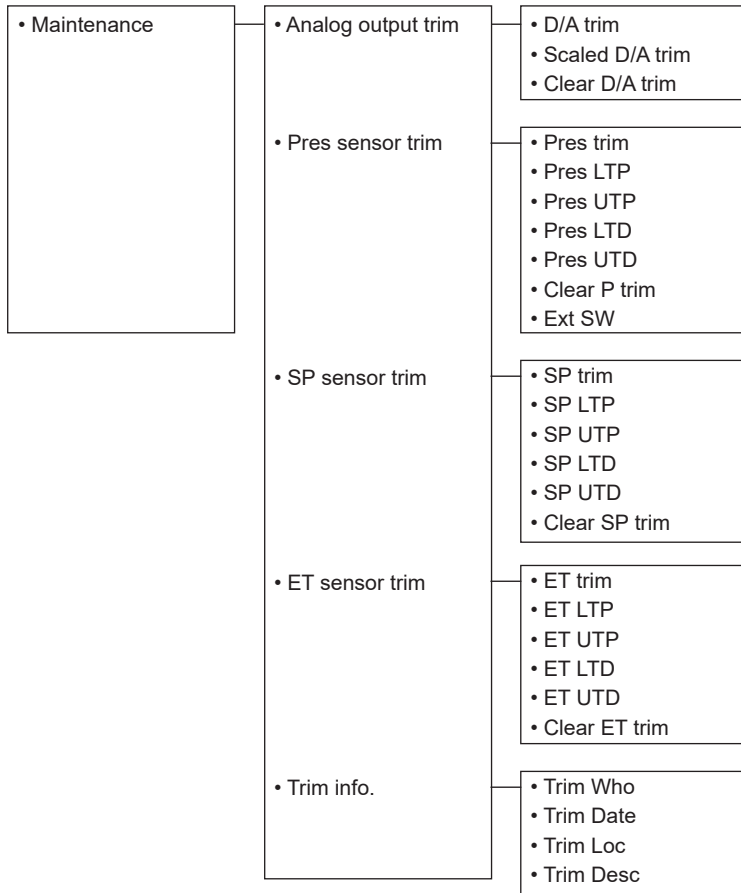

F0301-14.ai

3.2 Basic Setup



IMPORTANT

After setting and sending data with the HART configuration tool, wait 30 seconds before turning off the transmitter. If it is turned off too soon, the settings will not be stored in the transmitter.



NOTE

For the procedures to call each designated parameter, please refer to Chapter 6.

3.2.1 Tag and Device Information

If there are specified when ordering, the desired Tag No. and device information are set and shipped. Tag No. and device information can be checked as follows.

- Procedure to call up the display

| Item | Procedure |
|------------|---|
| Tag | [Root Menu] → Basic setup → Device information (or Tag) → Tag |
| Long Tag | [Root Menu] → Basic setup → Device information → Long Tag HART 7 |
| Descriptor | [Root Menu] → Basic setup → Device information → Descriptor |
| Message | [Root Menu] → Basic setup → Device information → Message |
| Date | [Root Menu] → Basic setup → Device information → Date |

- In case of EJX910 V2.1 (HART 5 DTM)

| Item | Procedure |
|------------|---|
| Tag | Easy Setup → Tag or Configuration → HART → Tag |
| Descriptor | Configuration → Device information 1 → Descriptor |
| Message | Configuration → Device information 1 → Message |
| Date | Configuration → Device information 1 → Date |

When the Tag No. and device information are changed, input them based on the following limitations.

| Item | Limitations |
|------------|---|
| Tag | Up to 8 characters or numbers*1 |
| Long tag | Up to 32 characters or numbers*2 HART 7 |
| Descriptor | Up to 16 characters or numbers*1 |
| Message | Up to 32 characters or numbers*1 |
| Date | mm/dd/yyyy - mm: month (2 digits) - dd: days (2 digits) - yyyy: years (4 digits) |

*1: The characters bounded by the thick line in the following table can be used.

*2: All characters in the following table can be used.

| | | | | | | | | | | | | | | | |
|----|---|---|---|----|---|---|---|---|---|---|---|---|---|---|---|
| SP | ! | " | # | \$ | % | & | ' | (|) | * | + | , | - | . | / |
| 0 | 1 | 2 | 3 | 4 | 5 | 6 | 7 | 8 | 9 | : | ; | < | = | > | ? |
| @ | A | B | C | D | E | F | G | H | I | J | K | L | M | N | O |
| P | Q | R | S | T | U | V | W | X | Y | Z | [| \ |] | ^ | _ |
| ` | a | b | c | d | e | f | g | h | i | j | k | l | m | n | o |
| p | q | r | s | t | u | v | w | x | y | z | { | | } | ~ | |

*: SP shows one-byte space

3.2.2 Process Variable Setup

The multivariable transmitter can handle five kinds of Device Variables; differential pressure (DP), static pressure (SP), external temperature (ET), and also flow rate and total flow which are calculated by using these values.

Four data selected from these five data can be assigned to Dynamic Variables; PV (Primary Variable), SV (Secondary Variable), TV (Tertiary Variable) and 4V* (Fourth Variable) or QV* (Quaternary Variable).

Data assigned for PV become the 4 to 20mA current output.

Total flow can not be assigned to PV.

These data are set as follows when the instrument is shipped.

In case of measurement function code is "A" (Multi sensing):

PV: Differential pressure

SV: Static pressure

TV: External temperature

In case of measurement function code is "B" (Mass flow measurement):

PV: Flow rate

SV: Differential pressure

TV: Static pressure

4V/QV*: External temperature

*: 4V is for HART 5, QV is for HART 7

- Procedure to call up the display

| | |
|------------------------------------|--|
| PV related parameter | [Root Menu] → Process variables → Output vars → PV → |
| → PV is | Current PV value |
| → Change PV Assgn | Select the variable assigned to PV (Flow, Pres, SP, ET) |
| SV related parameter | [Root Menu] → Process variables → Output vars → SV → |
| → SV is | Current SV value |
| → Change SV Assgn | Select the variable assigned to SV (Flow, Pres, SP, ET, Total Flow) |
| TV related parameter | [Root Menu] → Process variables → Output vars → TV → |
| → TV is | Current TV value |
| → Change TV Assgn | Select the variable assigned to TV (Flow, Pres, SP, ET, Total Flow) |
| 4V/QV related parameter | [Root Menu] → Process variables → Output vars → 4V/QV → |
| → 4V is / QV is | Current 4V/QV value |
| → Change 4V Assgn /Change QV Assgn | Select the variable assigned to 4V/QV (Flow, Pres, SP, ET, Total Flow) |

- In case of EJX910 V2.1 (HART 5 DTM)

| | |
|--|---|
| PV related item | Configuration → Output Variables → |
| → PV is | Current PV value |
| → Change PV Assgn | Select the variable assigned to PV (Flow, Pres, SP, ET) |
| It is similar about SV, TV and 4V. The process variables that can be assigned are Flow, Pres, SP, ET, and Total Flow. | |

3.2.3 Measuring Range

This section shows how to confirm and change the parameters for measuring range of flow rate, differential pressure, static pressure, external temperature, and total flow, and also unit and damping time constant.

These parameters are set at the factory before shipment if specified at the time of order.

Follow the procedure below to change them.

About the differential pressure, static pressure and external temperature, settable range are shown on the parameters of LSL (Lower settable limit), USL (Upper settable limit) and Min span (Minimum span). Set the data within the range.

- Procedure to call up the display

| | |
|---|--------------------------------|
| Call up and setting of flow related parameters | |
| [Root Menu] → Detailed setup → Signal condition → Flow Setup → | |
| In case of EJX910 V2.1 (HART 5 DTM) Configuration → Flow → | |
| → Flow LRV | Lower range value for flow |
| → Flow URV | Upper range value for flow |
| → Flow Unit | Unit for flow |
| → Flow Damp | Damping time constant for flow |

| | |
|---|---|
| Call up and setting of differential pressure related parameters | |
| [Root Menu] → Detailed setup → Signal condition → Pres Setup (or DP Setup) → | |
| In case of EJX910 V2.1 (HART 5 DTM) Configuration → Pressure Sensor → | |
| → Pres LRV | Lower range value for differential pressure |
| → Pres URV | Upper range value for differential pressure |
| → Pres Unit | Unit for differential pressure |
| → Pres Damp | Damping time constant for differential pressure |

| | |
|---|---|
| Call up and setting of static pressure related parameters | |
| [Root Menu] → Detailed setup → Signal condition → SP Setup → | |
| In case of EJX910 V2.1 (HART 5 DTM) Configuration → Static Pressure Sensor → | |
| → SP LRV | Lower range value for static pressure |
| → SP URV | Upper range value for static pressure |
| → SP Unit | Unit for static pressure |
| → SP Damp | Damping time constant for static pressure |

| | |
|--|--|
| Call up and setting of external temperature related parameters | |
| [Root Menu] → Detailed setup → Signal condition → ET Setup → | |
| In case of EJX910 V2.1 (HART 5 DTM) Configuration → External Temperature Sensor → | |
| → ET LRV | Lower range value for external temperature |
| → ET URV | Upper range value for external temperature |
| → ET Unit | Unit for external temperature |
| → ET Damp | Damping time constant for external temperature |

| | |
|---|---------------------|
| Call up and setting of total flow related parameters | |
| [Root Menu] → Detailed setup → Signal condition → Total Flow → | |
| In case of EJX910 V2.1 (HART 5 DTM) Configuration → Total Flow → | |
| → Total Flow Unit | Unit for total flow |



NOTE

The calibration range can be set as PV LRV > PV URV under the following conditions, reversing the 4 to 20 mA output signal.

$$PV\ LSL - 10\% \text{ of } USL \leq PV\ LRV \leq PV\ USL + 10\% \text{ of } USL$$

$$PV\ LSL - 10\% \text{ of } USL \leq PV\ URV \leq PV\ USL + 10\% \text{ of } USL$$

$$|PV\ URV - PV\ LRV| \geq PV\ Min. \text{ Span}$$

If PV is flow, PV LRV and PV URV must be the following conditions.

$$0 \leq PV\ LRV$$

$$0 \leq PV\ URV$$

$$PV\ LRV < PV\ URV$$

The flow range is set to LRV=0 and URV=100 when the Flow calc mode is changed to Basic mode or Full Auto mode.

If PV is ET, PV LRV and PV URV must be the following conditions.

$$-210^{\circ}C \leq PV\ LRV \leq 860^{\circ}C$$

$$(-346^{\circ}F \leq PV\ LRV \leq 1580^{\circ}F)$$

$$-210^{\circ}C \leq PV\ URV \leq 860^{\circ}C$$

$$(-346^{\circ}F \leq PV\ URV \leq 1580^{\circ}F)$$

$$|PV\ URV - PV\ LRV| \geq PV\ Min. \text{ Span}$$

If PV is ET, PV LRV and PV URV are limited to the following ranges when the saturated steam mode (ET Fixed = Saturated Steam) is set.

$$100^{\circ}C \leq PV\ LRV \leq 349^{\circ}C$$

$$(212^{\circ}F \leq PV\ LRV \leq 660^{\circ}F)$$

$$100^{\circ}C \leq PV\ URV \leq 349^{\circ}C$$

$$(212^{\circ}F \leq PV\ URV \leq 660^{\circ}F)$$

3.2.4 Units

Refer to the subsection 3.2.3 to call up the display. Select the unit from displayed list as shown below.

(1) Unit list of differential pressure

mmH2O, mmH2O@68degF, mmHg, Torr, MPa, kPa, Pa, mbar, bar, gf/cm2, kgf/cm2, inH2O, inH2O@68degF, inHg, ftH2O, ftH2O@68degF, psi, atm, hPa

Note that the Yokogawa default setting for the standard temperature is 4°C (39.2°F). For the units of mmH2O, inH2O, and ftH2O, the pressure varies according to the standard temperature definition. Select the appropriate unit with @68degF when a standard temperature of 20°C (68°F) is required.

(2) Unit list of static pressure

mmH2O, mmH2O@68degF, mmHg, Torr, MPa, kPa, Pa, mbar, bar, gf/cm2, kgf/cm2, inH2O, inH2O@68degF, inHg, ftH2O, ftH2O@68degF, psi, atm, hPa

(3) Unit list of temperature

degC, degF, Kelvin*

*: In the case of using DTM(HART 7), it is displayed as "K".

(4) Unit list of flow

| | |
|-----------------------------|---|
| Mass Flow | g/s, g/min, g/h, kg/s, kg/min, kg/h, kg/d, t/min, t/h, t/d, lb/s, lb/min, lb/h, lb/d, STon/min, STon/h, STon/d, LTon/h, LTon/d |
| Normal/Standard Volume Flow | Nm3/h, NL/h, SL/h, SL/min, SL/s, Nm3/d, SCFD, SCFH, SCFM, SCFS, Sm3/d, Sm3/h, MSCFD, MMSCFD |
| Volume Flow | CFM, GPM, L/min, Impgal/min, m3/h, gal/s, Mgal/d, L/s, ML/d, CFS, ft3/d, m3/s, m3/d, Impgal/h, Impgal/d, CFH, m3/min, bbl/s, bbl/min, bbl/h, bbl/d, gal/h, Impgal/s, L/h, gal/d |

(5) Unit list of total flow

g, kg, t, lb, Ston, Lton, oz, gal, L, Impgal, m3, bbl, yd3, ft3, in3, Nm3, NL, SCF, Spcl*

* The user unit is displayed on LCD.
To configure the user unit, refer to subsection 3.3.5.

3.2.5 Damping Time Constant Setup

Any number from 0.00 to 100.00 can be set for the amplifier damping time constant of process variables.

Refer to subsection 3.2.3 to call up the display.

Damping time constant is set as shown in the following table at the factory when the instrument is shipped, but in case of the option code /CA is specified, the damping time constant is set as specified in the order.

| Process variables | Factory default value |
|-----------------------|-----------------------|
| Differential pressure | 2sec |
| Static pressure | 1sec |
| External temperature | 1sec |
| Flow rate | 0sec |



NOTE

- When the HART communication is used under the condition of quick output change, set the damping time constant more than 0.5 sec.
- The damping time constant for the amplifier assembly can be set here. The damping time constant for the entire transmitter is the sum of the values for the amplifier assembly and the capsule assembly.
About the value for the capsule assembly, refer to the User's Manual for EJX910/ EJX930 (IM 01C25R01-01E) or General Specifications (GS 01C25R01-01EN, GS 01C25R04-01EN).
- The damping setting of the external temperature is disabled, and its time constant value is treated as zero when the saturated steam mode (ET Fixed = Saturated Steam) is set.

3.2.6 Differential Pressure Signal Low Cut Mode Setup

Low cut mode can be used to stabilize the differential pressure output signal near the zero point. If the differential pressure output signal becomes 0% due to Low cut, the flow rate also becomes 0. The low cut point can be set from 0 to 20% of output. (Hysteresis for the cut point: ±10% of the cut point)

Follow the procedure below to change the Low cut mode and Low cut point.

- Procedure to call up the display

| | |
|--|-----------------------------|
| [Root Menu] → Basic setup → Others → | |
| In case of EJX910 V2.1 (HART 5 DTM) Configuration → Analog Output → | |
| → Low cut | Set from 0 to 20% of output |
| → Low cut mode | Select "On" or "Off" |

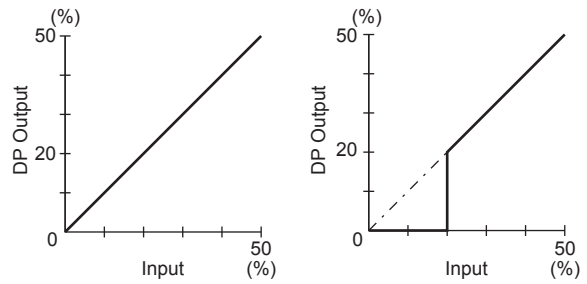

For low cut in Off mode

For low cut in On mode

F0302.ai

Figure 3.1 Low Cut Mode

The low cut point has hysteresis so that the output around the point is behaved as below figure.

<Example>

- Low cut mode: On
- Low cut: 20.00%

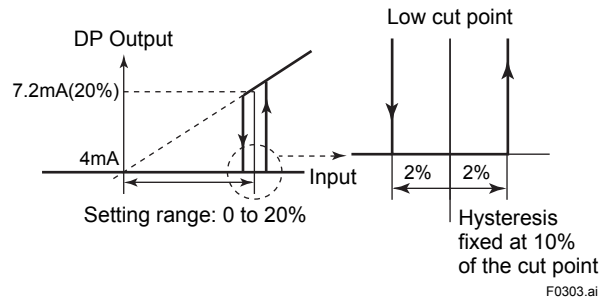

F0303.ai

3.2.7 Impulse Line Connection Orientation Setup

This function reverses the impulse line orientation. This function is used when the high pressure side impulse line and the low pressure side impulse line are connected reverse by mistake.

Follow the procedure below to assign the high pressure impulse line to the L side of the transmitter.

- Procedure to call up the display

| | |
|--|------------------------------|
| [Root Menu] → Basic setup → Others → | |
| In case of EJX910 V2.1 (HART 5 DTM) Configuration → Pressure Sensor → | |
| → H/L Swap | Select "Normal" or "Reverse" |

3.3 Detailed Setup

3.3.1 Analog Output Signal Adjustable Range

Output signal adjustable range at normal operating condition are set as shown below at the factory when the instrument is shipped, and output signal are limited by these value.

| | Lower limit | Upper limit |
|-----------------------------|----------------------|------------------------|
| Standard Option code /C1 | 3.8 mA (3.808 mA) | 21.6 mA (21.600 mA) |
| Option code /C2 and /C3 | 3.8 mA (3.808 mA) | 20.5 mA (20.496 mA) |

* The number of digits displayed is different by the device revision. 3 digits after the decimal point are displayed when the device revision is 12 or later.

Output signal range can be changed between 3.8mA and 21.6mA to match it to the equipment on the receiving side.

Lower value is set at **AO lower limit** and upper value is set at **AO upper limit** respectively.

Follow the procedure below to change the upper and lower values.

- Procedure to call up the display

| | |
|--|--------------------------|
| [Root Menu] → Detailed setup → Output condition → Analog output → | |
| ----- | |
| In case of EJX910 V2.1 (HART 5 DTM) Configuration → Analog output → | |
| → AO lower limit | Set the lower value (mA) |
| → AO upper limit | Set the upper value (mA) |

Set the values as below.
Lower value < Upper value

3.3.2 Static Pressure Setup

(1) Selection of Gauge pressure and Absolute pressure

Either the gauge pressure or absolute pressure can be selected to display on the LCD display.

Absolute pressure is selected when the instrument is shipped.

- Procedure to call up the display

| | |
|---|------------------------------|
| [Root Menu] → Detailed setup → Signal condition → SP Setup → | |
| ----- | |
| In case of EJX910 V2.1 (HART 5 DTM) Configuration → Static Pressure Sensor → | |
| → A / G Select | Select "Gauge" or "Absolute" |

(2) Selection of pressure side

Either the high or low pressure side of capsule can be selected to monitor the static pressure.

High pressure side is selected when the instrument is shipped.

- Procedure to call up the display

| | |
|---|------------------------|
| [Root Menu] → Detailed setup → Signal condition → SP Setup → | |
| ----- | |
| In case of EJX910 V2.1 (HART 5 DTM) Configuration → Static Pressure Sensor → | |
| → SP H/L Select | Select "High" or "Low" |

3.3.3 External Temperature Fixation Mode

The external temperature can be fixed with this mode. The parameter setting to enter the Fixation Mode when the RTD sensor is disconnected is also possible.

The saturated steam mode (ET Fixed = Saturated Steam) can be set when the device revision is 12 or later. External temperature is calculated from static pressure by using the built-in steam table (IAPWS-IF97) and its value limit is 90 to 374°C when the mode is set. A static pressure range corresponding to the external temperature range is 70 kPa to 22.064 MPa. Errors caused by disconnection of RTD sensor do not occur in the mode.



NOTE

Setting of the ET fixed mode affects the external temperature range (ET LRV/URV) that can be set (Saturated steam mode: 100 to 349°C, Others: -210 to 860°C). Set the properly external temperature range when the mode is saturated steam.



NOTE

External temperature configuration and value is limited when calculating flow value of saturated steam (Following IAPWS-IF97).

1. Output external temperature measured by RTD sensor:
Configuration: ET Fixed = No
External temperature value limit: 0 to 374°C (Under saturated steam state)
2. Output external temperature calculated from the static pressure by using the built-in steam table:
Configuration: ET Fixed = Saturated Steam
External temperature value limit: 90 to 374°C







- Procedure to call up the display

| | |
|---|---|
| [Root Menu] → Detailed setup → Signal condition → ET Setup → Fixed ET → ----- In case of EJX910 V2.1 (HART 5 DTM) Configuration → External Temperature Sensor → | |
| → ET Fixed | Select "No", "Yes", "FALL BACK" or "Saturated Steam" No: Shows process temperature value Yes: Fix the temperature value FALL BACK: Fix the temperature value when the RTD sensor is disconnected. Saturated Steam: The external temperature can be calculated from static pressure by using the built-in steam table (only available in device revision 12 or later). |
| → Fixed ET Val | Set the fixed temperature value |

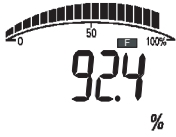
3.3.4 Integral Indicator Scale Setup

The following seven displays are available for integral indicator. A cycle of up to four displays can be shown by assigning variables to the parameters at **Disp select**.

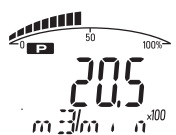
- % of PV range
- Flow rate
- Input differential pressure
- Input static pressure
- Input external temperature
- User set scaled PV
- Total flow

| Available displays | Description and related parameters |
|--|---|
| % of PV range (PV %)  | Indicates input value depending on the set PV range (PV LRV and PV URV). PV % 92.4 % |
| Flow rate (Flow)  | Indicates values of calculated flow with the indication limits -99999 to 99999. Flow 26.0 kg/h |
| Input differential pressure (Pres)  | Indicates values of input differential pressure with the indication limits -99999 to 99999. PRES 45.6 kPa |
| Input static pressure (SP)  | Indicates values of input static pressure with the indication limits -99999 to 99999. SP 6.178 MPa |
| Input ext. temperature (ET) ^{*1}  | Indicates values of input external temperature with the indication limits -99999 to 99999. ET 22.95 degC |
| User set scaled PV (Engr Disp) ^{*2}  | Indicates values depending on the engineering range (Engr LRV and Engr URV) with the unit (Engr Unit). Engr LRV 0.0 Engr URV 45.0 Engr exp x100 Engr Unit m3/min Engr point 1 |
| Total flow (Total Flow) ^{*3}  | Indicates values of calculated total flow with the indication limits as follows. 0 to 9.99E29 (Normal mode) 0 to 999999 (Cyclic mode) Total Flow 68.259 kg |

F0304.ai

*1 : "EXT. TEMP" for DD and EJX910 V2.1 (HART 5 DTM)
 *2 : "ENGR. PV" for DD and EJX910 V2.1 (HART 5 DTM)
 *3 : "TOTAL FLOW" for DD and EJX910 V2.1 (HART 5 DTM)

See (a) through (d) for the setting procedures.

a. Display Selection

At **Disp select**, select the variable that the parameter Disp 1 will display on the integral indicator.

- Procedure to call up the display

| | |
|---|--|
| [Root Menu] → Detailed setup → Display condition → Disp select → | |
| ----- | |
| In case of EJX910 V2.1 (HART 5 DTM) Configuration → Local Display → | |
| → Disp 1 / Disp Out 1 | Select desired display from seven kinds of displays shown above. |

Set Disp 2, Disp 3 and Disp 4 in the same way if necessary.

In addition to the above item, "Not used" is also displayed as a selection item.

b. Cyclic Display

Up to four displays can be displayed cyclically in the order of the parameter number.

c. Display Resolution

User can change the position of decimal point which is shown on the integral indicator.

- Procedure to call up the **Disp % reso** display

| | |
|---|--|
| [Root Menu] → Detailed setup → Display condition → Disp condition → | |
| ----- | |
| In case of EJX910 V2.1 (HART 5 DTM) Configuration → Local Display → | |
| → Disp % Reso | Select the decimal point position of PV% Normal: Display one digit below the decimal point High Resolution: Display two digits below the decimal point |

- Procedure to call up the **Flow Disp point , Pres disp point , SP disp point , ET disp point , TF disp point** display

| | |
|---|--|
| [Root Menu] → Detailed setup → Display condition → Disp condition → | |
| ----- | |
| In case of EJX910 V2.1 (HART 5 DTM) Configuration → Local Display → | |
| → Flow disp point | Select the decimal point position of flow rate (0, 1, 2, 3 or 4) |
| → Pres disp point | Select the decimal point position of differential pressure (0, 1, 2, 3 or 4) |
| → SP disp point | Select the decimal point position of static pressure (0, 1, 2, 3 or 4) |
| → ET disp point | Select the decimal point position of external temperature (0, 1, 2, 3 or 4) |
| → TF disp point | Select the decimal point position of total flow (0, 1, 2, 3 or 4) |

d. User Setting of Engineering Unit and Scale

Engr disp range parameters allow the engineering unit and scale to be displayed. At **Set Engr Unit**, the following engineering units can be selected from a list.

- Procedure to call up the display

| | |
|--|---|
| [Root Menu] → Detailed setup → Display condition → Engr disp range → | |
| → Set Engr Unit | Select the engineering unit |
| → Engr LRV | Lower range value |
| → Engr URV | Upper range value |
| → Engr exp | Exponents for user scale display |
| → Engr point | Decimal point position for user scale display |

Select the engineering unit from the list. Available units are shown below

| | | |
|-------|----------------------|----------------------|
| kPa | ftH2O | NI/min |
| MPa | gf/cm ² | Nm ³ /h |
| mbar | kgf/cm ² | Nm ³ /min |
| bar | kg/cm ² G | ACFH |
| psi | kg/cm ² A | ACFM |
| psia | atm | CFH |
| mmH2O | kg/h | SCFM |
| mmHg | t/h | GPH |
| mmHgA | m ³ /h | GPM |
| mmAq | m ³ /min | m |
| mmWG | l/h | mm |
| Torr | l/min | in |
| inH2O | kl/h | ft |
| inHg | kl/min | kg/m ³ |
| inHgA | NI/h | g/cm ³ |

At **Modify Engr Unit** parameter, user can set your own unit also.

Up to eight alphanumeric characters, spaces or one slashe (/) can be input at **Modify Engr Unit**; only the first six are displayed on the integral indicator.

- Procedure to call up the display

| | |
|--|-------------------|
| [Root Menu] → Detailed setup → Display condition → Engr disp range → | |
| → Modify Engr Unit | Set your own unit |

Note that following symbols are not available:

% & < > . * : + - , ' ()

The integral indicator shows "-----" when these symbols or more than two slashes are entered.

- In case of EJX910 V2.1 (HART 5 DTM) User can input the desired unit at **Engr Unit**.

- Procedure to call up the display

| | |
|---------------------------------|---|
| Configuration → Local Display → | |
| → Engr Unit | Set the engineering unit |
| → Engr LRV | Lower range value |
| → Engr URV | Upper range value |
| → Engr exp | Exponents for user scale display |
| → Engr point | Decimal point position for user scale display |

Available characters and symbols for **Engr Unit** are the same as for **Modify Engr Unit** shown above.

3.3.5 Total Flow Setup

(1) Mode setting

Set the parameters to start, stop, and reset the total flow.

To start the total flow measurement by normal mode, call up the **Total Flow Mode** display and set the mode.

- Procedure to call up the display

| | |
|--|---|
| [Root Menu] → Detailed setup → Signal condition → Total Flow → Total Flow Mode → | |
| ----- In case of EJX910 V2.1 (HART 5 DTM) Configuration → Total Flow → Total Flow Mode → | |
| Reset | Reset the total flow value |
| Start | Start the total flow measurement. Total value is limited at 9.99E29. |
| Stop | Stop the total flow measurement |
| Start Cyclic | Start the total flow measurement. When the total flow value reaches 999999, the count restarts at 0. |

(2) User unit configuration

You can set your own unit for total flow.

Select the Base Unit as an base unit, then set the Cvt Val for the conversion coefficient with the user unit.

- Procedure to call up the display

| | |
|---|------------------------------------|
| [Root Menu] → Detailed setup → Signal condition → Total Flow → Config User Unit → | |
| → Set Base Unit | Select the Base Unit from the list |
| → Modify Unit | Set the special total flow unit |
| → Cvt Val | Enter the conversion value |

- In case of EJX910 V2.1 (HART 5 DTM)

| | |
|--------------------------------|------------------------------------|
| Configuration → Total Flow → | |
| → Conf User Unit Set Base Unit | Select the Base Unit from the list |
| → Conf User Unit Modify Unit | Set the special total flow unit |
| → Conf User Unit Cvt Val | Enter the conversion value |

Base Unit

| | | |
|------|--------|-----|
| g | oz | yd3 |
| kg | gal | ft3 |
| t | L | in3 |
| lb | Impgal | Nm3 |
| STon | m3 | NL |
| LTon | bbl | SCF |

Typical Unit Conversion Factor

| |
|---|
| Use "kg" in case of mass flow |
| Use "m3" in case of volume flow |
| Use "Nm3" in case of normal or standard volume flow |

| Set Base Unit | User Unit | Convert val |
|---------------|-----------|-------------|
| kg | g | 1.0000E+03 |
| | kg | 1.0000E+00 |
| | t | 1.0000E-03 |
| | lb | 2.2046E+00 |
| | STon | 1.1023E-03 |
| | LTon | 9.8421E-04 |
| | oz | 3.5274E+01 |
| m3 | gal | 2.6417E+02 |
| | L | 1.0000E+03 |
| | Impgal | 2.1997E+02 |
| | m3 | 1.0000E+00 |
| | bbl | 6.2898E+00 |
| | bushel | 2.8378E+01 |
| | yd3 | 1.3080E+00 |
| | ft3 | 3.5315E+01 |
| | in3 | 6.1024E+04 |
| | bbl | 6.2898E+00 |
| | hl | 1.0000E+01 |
| Nm3 | Nm3 | 1.0000E+00 |
| | NL | 1.0000E+03 |
| | SCF | 3.5315E+01 |

<Example>

Set the special total flow unit as g (=0.001kg) based kg.

(1kg=1.0000E+03g)

- 1) Select "kg" for **Set base unit** (or **Conf User Unit Set Base Unit**).
- 2) Set "g" for **Modify Unit** (or **Conf User Unit Modify Unit**).
- 3) Enter 1.0000E+03 for Cvt Val (or Conf User Unit Cvt Val).



NOTE

Up to eight alphanumeric characters, spaces or slash(/) can be input for **Modify Unit** (or **Conf User Unit Modify Unit**).

only the first six are displayed on the integral indicator.

Note that following symbols are not available.

% & < > . * : + - , ' ()

The integral indicator shows “-----” when these symbols or more than two slashes are entered.

3.3.6 Sensor Trim

EJX multivariable transmitter is factory characterized. Factory characterization is the process of comparing a known pressure input with the output of each transmitter sensor module over the entire pressure and temperature operating range. During the characterization process, this comparison information is stored in the transmitter EEPROM. In operation, the transmitter uses this factory-stored curve to produce a process variable output (PV), in engineering units, dependent on the pressure input.

The sensor trim procedure allows you to adjust for local conditions, changing how the transmitter calculates process variables. There are two ways to trim the sensor: a zero trim and a full sensor trim. A zero trim is a one-point adjustment typically used to compensate for mounting position effects or zero shifts caused by static pressure. A full sensor trim is a two-point process, in which two accurate end-point pressures are applied (equal to or greater than the range values), and all output is linearized between them.

Full Sensor Trim—Auto Trim and Manual Trim

Full sensor trim is carried out by performing **Auto, Lower Pt** followed by **Auto, Upper Pt**.

Also, you can manually perform the trimming procedure with **Manual, Lower Pt** and **Manual, Upper Pt**.

The full sensor trim is a two-point adjustment, and the lower point adjustment should always be performed before the upper point adjustment in order to maintain the pitch between the zero and 100% points within the calibration range.

In the manual method, the reference pressure should also be applied to the transmitter at both the lower and upper points. Without the reference pressure, **Manual, Lower Pt** and **Manual, Upper Pt** may not represent the correct value for each adjustment point.

(1) Auto Sensor Trim

Applying reference pressure of 0% and 100% of the measurement range to the transmitter, adjust the lower and upper points automatically.

- Procedure to call up the display

| | |
|--|--------------------------|
| [Root Menu] → Maintenance (or → Diag/Service → Calibration) → Pres sensor trim → Pres trim → | |
| ----- | |
| In case of EJX910 V2.1 (HART 5 DTM) Calibration → Pressure trim → | |
| → Auto, Lower Pt | Auto trim for 0% point |
| → Auto, Upper Pt | Auto trim for 100% point |

(2) Manual Sensor Trim

Using the example below, follow the steps to perform the full sensor trim manually. The Pres LTD (Manual, Lower Pt) and Pres UTD (Manual, Upper Pt) represent the previously adjusted values.

| |
|--|
| Example: For the range of 1000 to 3000 mmH ₂ O |
| Pres LTD (Manual, Lower Pt) = -4.0 mmH₂O |
| Pres UTD (Manual, Upper Pt) = -3.0 mmH₂O |

- <1> Call up the **Manual, Lower Pt**.

- Procedure to call up the display

| | |
|--|----------------------------|
| [Root Menu] → Maintenance (or → Diag/Service → Calibration) → Pres sensor trim → Pres trim → | |
| ----- | |
| In case of EJX910 V2.1 (HART 5 DTM) Calibration → Pressure trim → | |
| → Manual, Lower Pt | Manual trim for 0% point |
| → Manual, Upper Pt | Manual trim for 100% point |

- <2> Suppose that a standard pressure of 1000 mmH₂O is applied and the value of the “Pres for trim” is 994.0. Correct for this output error of 6 mmH₂O by adding 6 mmH₂O to **Pres LTD (Manual, Lower Pt)**.

$$-4.0+6.0=+2.0$$

- <3> Enter the correction value of “2” to the **Pres LTD (Manual, Lower Pt)**.

- <4> Call up the **Pres UTD (Manual, Upper Pt)**.

<5> Suppose that a standard pressure of 3000 mmH₂O is applied and the value of the Pres for trim is 3015.0. Firstly, obtain the slope error for the span as follows;

$$\text{Slope Error} = \frac{\text{Applied Pressure Value} - \text{Value of Pres for Trim}}{\text{Applied Pressure Value} - \text{LRV}} \times (\text{URV} - \text{LRV})$$

$$= \frac{3000 - 3015}{3000 - 1000} \times (3000 - 1000) = -15$$

Then correct for this slope error of -15 by adding -15 to **Pres UTD (Manual, Upper Pt)**.
 -3.0 + (-15.0) = -18.0

<6> Enter the correction value of “-18” to the **Pres UTD (Manual, Upper Pt)**.

(3) Sensor Trim for Static Pressure or External Temperature

For the EJX multivariable transmitter, full sensor trim of the static pressure or external temperature is performed in the same way as with the differential pressure.

When the saturated steam mode (ET Fixed = Saturated Steam) is set, zero-point adjustment of the external temperature is disabled, and its trim value (ET LTD) is treated as zero. The unit of this trim value is ET unit.

- Procedure to call up the display for static pressure

| | |
|---|----------------------------|
| [Root Menu] → Maintenance (or → Diag/Service → Calibration) → SP sensor trim → SP trim → | |
| ----- | |
| In case of EJX910 V2.1 (HART 5 DTM) Calibration → Static Pressure trim → | |
| → Auto, Lower Pt | Auto trim for 0% point |
| → Auto, Upper Pt | Auto trim for 100% point |
| → Manual, Lower Pt | Manual trim for 0% point |
| → Manual, Upper Pt | Manual trim for 100% point |

- Procedure to call up the display for external temperature

| | |
|---|----------------------------|
| [Root Menu] → Maintenance (or → Diag/Service → Calibration) → ET sensor trim → ET trim → | |
| ----- | |
| In case of EJX910 V2.1 (HART 5 DTM) Calibration → External Temp trim → | |
| → Auto, Lower Pt | Auto trim for 0% point |
| → Auto, Upper Pt | Auto trim for 100% point |
| → Manual, Lower Pt | Manual trim for 0% point |
| → Manual, Upper Pt | Manual trim for 100% point |

(4) Reset Trim Adjustment to Factory Setting

The **Clear P trim**, **Clear SP trim** and **Clear ET trim** commands can reset the trim adjustment to the initial calibrated values that were set. The amount of the adjustment performed with the external zero-adjustment screw is returned to the initial setting as well.

- Procedure to call up the display for differential pressure

| |
|--|
| [Root Menu] → Maintenance (or → Diag/Service → Calibration) → Pres sensor trim → Clear P trim → Execute |
| ----- |
| In case of EJX910 V2.1 (HART 5 DTM) Calibration → Clear Pressure Sensor trim → Execute |

- Procedure to call up the display for static pressure

| |
|---|
| [Root Menu] → Maintenance (or → Diag/Service → Calibration) → SP sensor trim → Clear SP trim → Execute |
| ----- |
| In case of EJX910 V2.1 (HART 5 DTM) Calibration → Clear Static Pressure Sensor trim → Execute |

- Procedure to call up the display for external temperature

| |
|---|
| [Root Menu] → Maintenance (or → Diag/Service → Calibration) → ET sensor trim → Clear ET trim → Execute |
| ----- |
| In case of EJX910 V2.1 (HART 5 DTM) Calibration → Clear External Temp Sensor trim → Execute |

3.3.7 Trim Analog Output

Fine current output adjustment is carried out with **D/A trim** or **Scaled D/A trim**.

(1) D/A Trim

D/A trim is to be carried out if the calibration digital ammeter does not exactly read 4.000 mA and 20.000 mA with an output signal of 0% and 100%.

- Procedure to call up the **D/A trim** display

| |
|--|
| [Root Menu] → Maintenance (or → Diag/Service → Calibration) → Analog output trim → D/A trim |
| ----- |
| In case of EJX910 V2.1 (HART 5 DTM) Calibration → D/A trim |

(2) Scaled D/A Trim

Scaled D/A trim is to be carried out if the output is adjusted using a voltmeter or a meter whose scale is 0 to 100%.

- Procedure to call up the **Scaled D/A trim** display

| |
|--|
| [Root Menu] → Maintenance (or → Diag/Service → Calibration) → Analog output trim → Scaled D/A trim |
| In case of EJX910 V2.1 (HART 5 DTM) Calibration → Scaled D/A trim |

<Example>

Adjustment using a volt meter. (4mA → 1V, 20mA → 5V)

- 1) Select "Change".
- 2) Enter the value read on the voltmeter when the output signal is 4mA.
In this case, enter the value of the voltage across a 250Ω resistor (1V).
- 3) Enter the value read on the meter when the output signal is 20mA (5V).
- 4) Select "Proceed".
- 5) Connect the voltmeter.
- 6) Output the 0% output signal and read the output value.
- 7) Enter the reading of the voltmeter to the configuration tool. (The output of the transmitter changes).
- 8) Confirm the voltmeter reading is 1.000.
- 9) If the reading on the voltmeter is 1.000, select "Yes".
If the reading is not 1.000, select "No" and repeat steps 6 and 7 until the voltmeter reads 1.000V.
- 10) Output the 100% output signal and read the output value.
- 11) Enter the reading of the voltmeter.
- 12) Confirm the voltmeter reading is 5.000.
- 13) If the reading of the voltmeter is 5.000, select "Yes".
If the reading on the voltmeter is not 5.000, select "No" and repeat steps 10 and 11 until the voltmeter reads 5.000V.

3.3.8 External Switch Mode

Follow the procedure below to enable or inhibit zero point adjustment by means of the zero-adjustment screw on the transmitter.

This is set to "Disabled" when the instrument is shipped.

To change the mode, follow the procedure below.

- Procedure to call up the display

| | |
|---|--|
| [Root Menu] → Detailed setup → Device information → Field device info → Field device info → Ext SW (or → Maintenance → Pres sensor trim → Ext SW) | |
| In case of EJX910 V2.1 (HART 5 DTM) Configuration → Device information1 → Ext SW | |
| Enabled | Enable the external zero point adjustment |
| Disabled | Disable the external zero point adjustment |

3.3.9 CPU Failure Burnout Direction and Hardware Write Protect

There are two slide switches on the CPU assembly board. One sets the burnout direction at CPU failure, and the other sets a write protection function which disables parameter changes through the use of a handheld terminal or some other communication method.

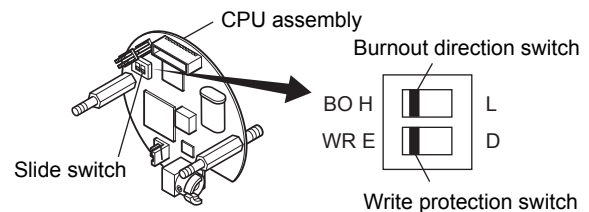

| Burnout direction switch (BO) | | |
|-----------------------------------|------------|------------|
| Burnout Direction Switch Position | H L E D | H L E D |
| Burnout Direction | HIGH | LOW |

| Hardware write protection switch (WR) | | |
|---------------------------------------|-----------------------|-------------------------|
| Write Protection Switch Position | H L E D | H L E D |
| Write Protection | NO (Write enabled) | YES (Write disabled) |

F0305.ai

The parameter of **AO alm typ** parameter displays the status of 4-20 mA DC output if a CPU failure occurs. In case of a failure, communication is disabled.

Standard specifications or with option code /C3

The burnout direction switch is set to "HIGH". If a failure occurs, the transmitter outputs a 110% or higher signal.

With option code /C1 or /C2

The burnout direction switch is set to "LOW". If a failure occurs, a -2.5% or lower output is generated.

To confirm the burnout direction at the CPU failure, follow the procedure below.

- Procedure to call up the display

| | |
|---|----------------------------------|
| [Root Menu] → Detailed setup → Output condition → Analog output → AO alm typ | |
| ----- | |
| In case of EJX910 V2.1 (HART 5 DTM) Configuration → Analog output → AO alm typ | |
| High | Burnout direction is set to High |
| Low | Burnout direction is set to Low |

3.3.10 Software Write Protection

EJX multivariable transmitter configured data is saved by using a write protection function. The write protection status is set to “Yes” when 8 alphanumeric characters are entered in the **New password** field and transferred to the transmitter.

When write protection is set to “Yes,” the transmitter does not accept parameter changes. When the same eight alphanumeric string entered in the **New password** field is also entered in the **Enable wrt 10min** field and transferred to the transmitter, it will be possible to change transmitter parameters during a 10 minute period.

To change the transmitter from the write protection “Yes” status back to write protection “No” status, use **Enable wrt 10min** to first release the write protection function and then enter eight spaces in the **New password** field.

- Procedure to call up the display

| | |
|--|--|
| [Root Menu] → Detailed setup → (Device information → Field device info →) Wrt protect menu → | |
| → Write Protect | Display current protect mode (Yes: protected, No: not protected) |
| → Enable wrt 10 min | Release the protect function for 10 min. |
| → New password | Set the new password or change the password |

- In case of EJX910 V2.1 (HART 5 DTM)

| | |
|----------------------|--|
| Write Protect → | |
| → Write Protect | Display current protect mode (Yes: protected, No: not protected) |
| → Enter new password | Enter the password here to enable the protect function. Enter eight spaces to disable the protect function. |
| → Enable write | Enter the password here to release the protect function for 10 min. |

3.3.11 Alarm

The function is used to display the alarm codes when the input differential pressure exceeds the specified value within the calibration range. The same is available for the input static pressure, external temperature, and flow rate. Refer to table 4.5 Alarm Message Summary for the specific alarm code to be generated.

(1) Alarm Setting

Select the process variable at **Process Alert** which the alarm is set, then set the alert mode for that value.

- Procedure to call up the display

| | |
|---|--|
| [Root Menu] → Detailed setup → Output condition → Process Alerts → Pres Alert, SP Alert, ET Alert or Flow Alert → | |
| ----- | |
| In case of EJX910 V2.1 (HART 5 DTM) Configuration → Process Alerts → | |
| Selection of the process variable for alarm | → Pres Alert Mode: Differential pressure |
| | → SP Alert Mode: Static pressure |
| | → ET Alert Mode: External temperature |
| | → Flow Alert Mode: Flow rate |
| Selection of alert mode | Off: Disable the alert function |
| | Hi AI Detect: High side alert detection |
| | Lo AI Detect: Low side alert detection |
| | Hi/Lo AI Detect: High and Low side alert detection |

(2) Threshold Level Setting

Set the threshold of high and low alert value for alarm generation.

- Procedure to call up the display

| [Root Menu] → Detailed setup → Output condition → Process Alerts → Pres Alert, SP Alert, ET Alert or Flow Alert → | |
|---|---|
| ----- | |
| In case of EJX910 V2.1 (HART 5 DTM) Configuration → Process Alerts → | |
| Parameter | Detail |
| → Pres Hi Alert Val | Set the threshold value of upper side for differential pressure |
| → Pres Lo Alert Val | Set the threshold value of lower side for differential pressure |
| → SP Hi Alert Val | Set the threshold value of upper side for static pressure |
| → SP Lo Alert Val | Set the threshold value of lower side for static pressure |
| → ET Hi Alert Val | Set the threshold value of upper side for external temperature |
| → ET Lo Alert Val | Set the threshold value of lower side for external temperature |
| → Flow Hi Alert Val | Set the threshold value of upper side for flow rate |
| → Flow Lo Alert Val | Set the threshold value of lower side for flow rate |

3.3.12 Status Output and Pulse Output

EJX multivariable transmitter has a contact output. Select the type of output, status output or pulse output, and set the unit, value etc.

(1) Selecting of output signal

Status output or pulse output can be selected for the contact output.

- Procedure to call up the display

| | | |
|---|---------------------|--|
| [Root Menu] → Detailed setup → Output condition → Process Alerts → DO config → DO Signal type | | |
| ----- | | |
| In case of EJX910 V2.1 (HART 5 DTM) Configuration → Process Alerts → DO Signal type | | |
| Status Output | On When Al. Detect | Output is "ON" when alert is detected |
| | Off When Al. Detect | Output is "OFF" when alert is detected |
| Pulse Output | Scaled Pulse | Scaled pulse output |
| | Frequency | Frequency output |

<Example>

Set the status output to output an off signal when the input pressure exceeds 75 kPa with the alert mode of Hi. Al Detect.

- 1) Select "Off When Al. Detect"
- 2) Select "Pres Alert Mode: Differential pressure" (Refer to subsection 3.3.11(1) Alarm Setting)
- 3) Select "Hi Al Detect: High side alert detection" (Refer to subsection 3.3.11(1) Alarm Setting)
- 4) Enter "75kPa" to **Pres Hi Alert Val** (Refer to subsection 3.3.11(2) Threshold Level Setting)



CAUTION

Whenever turning on the transmitter or detecting the short interruption, check if contact output correctly reflects the alarm status and test the ON/OFF action of contact output by the parameter **DO test** to confirm that the contact output operates correctly.

(2) Setting of status output

This feature is used for a transistor output (open collector) of an on/off signal according to the status of high and low alarm limits, which are user-configurable values as shown in subsection 3.3.11 Alarm. The status output can be assigned as any combination of the high or low limits of the input pressure, input static pressure, external temperature, or flow.

- Procedure to call up the display

| [Root Menu] → Detailed setup → Output condition → Process Alerts → DO config → DO Select | |
|--|---|
| ----- | |
| In case of EJX910 V2.1 (HART 5 DTM) Configuration → Process Alerts → DO Select | |
| Display Item | Contents (Select a output variable from the list below) |
| Off | – |
| Pres | Differential pressure |
| SP | Static pressure |
| Temp | External temperature |
| Pres/SP | Differential pressure and static pressure |
| Pres/Temp | Differential pressure and external temperature |
| SP/Temp | Static pressure and external temperature |
| Pres/SP/Temp | Differential pressure, static pressure and external temperature |
| Flow | Flow rate |
| Pres/Flow | Differential pressure and flow rate |
| SP/Flow | Static pressure and flow rate |
| Temp/Flow | External temperature and flow rate |
| Pres/SP/Flow | Differential pressure, static pressure and flow rate |
| Pres/Temp/Flow | Differential pressure, external temperature and flow rate |
| SP/Temp/Flow | Static pressure, external temperature and flow rate |
| Pres/SP/Temp/Flow | Differential pressure, static pressure, external temperature and flow rate |
| Diag Alarm | Alarm for advanced diagnostics (Refer to subsection 4.2.2.5) |
| All | Alarm for differential pressure, static pressure, external temperature, flow rate, and advanced diagnostics |



NOTE

No status output signal has been defined for a CPU failure or hardware error. Use a 4-20 mA signal to indicate a transmitter's failure.

Example: Status output operation of ON WHEN AL. DETECT

● Status output for higher alert value

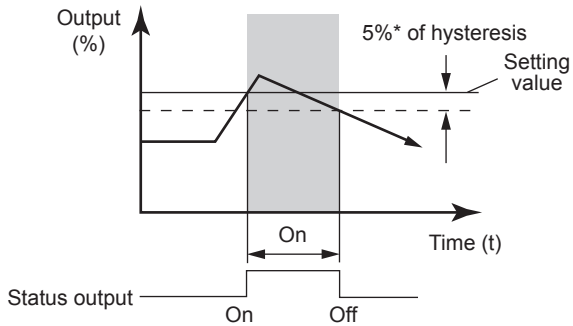

● Status output for lower alert value

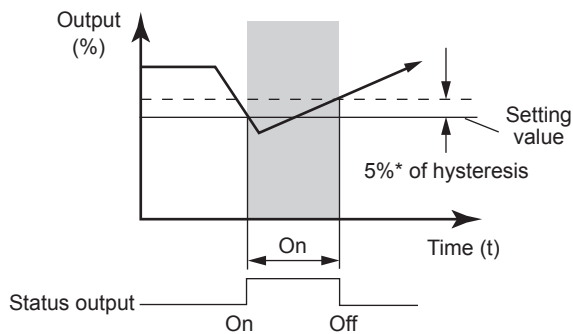

*: 5% of setting span for differential pressure / pressure

F0306.ai

Figure 3.2 Status Output

(3) Setting of pulse output

When the pulse output is used, either scaled pulse output or frequency output is selected in subsection 3.3.12 (1).

Then configure the parameter shown below.

- a. Scaled pulse
A single pulse is output for a specified flow amount.
- b. Frequency output
The flow rate is determined from the number of output pulses per second.

Example of Pulse Output

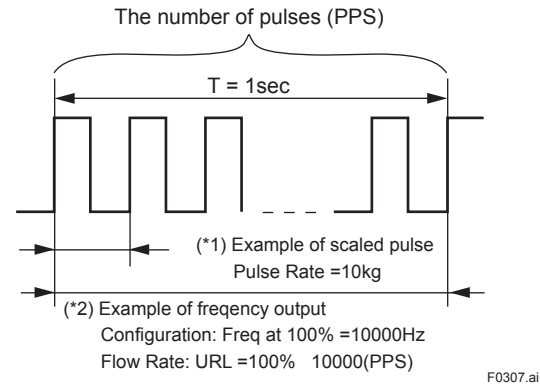

● Scaled pulse

- Procedure to call up the display

| | |
|---|---|
| [Root Menu] → Detailed setup → Signal condition → Total Flow → | |
| In case of EJX910 V2.1 (HART 5 DTM) Configuration → Total Flow → | |
| → Total Flow Unit | Select the unit of total flow |
| → Pulse rate | Set the volumetric flow rate or mass flow rate per one pulse. |

<Example>

Scaled pulse 10 kg Set

- 1) Enter “kg” to **Total Flow Unit**
- 2) Enter “10” to **Pulse rate**

● Frequency output

- Procedure to call up the display

| | |
|---|---|
| [Root Menu] → Detailed setup → Signal condition → Total Flow → | |
| In case of EJX910 V2.1 (HART 5 DTM) Configuration → Total Flow → | |
| → Freq at 100% | Set the number of output pulse per second at 100% flow rate. Max. frequency: 10kHz Duty cycle: Approx 50% |

<Example>

Freq at 100% is 10000 Hz Set

- 1) Enter “10000” to **Freq at 100%**

3.3.13 Test Output, Simulation, and Squawk



NOTE

Fixed current output, DO Test, Flow Simulation Mode, and Device Variable Simulation Function continue for a given holding time, then is released automatically. Even if the HART configuration tool power supply is turned off or the communication cable is disconnected, the test output will continue for that time.

The holding time can be selected from 10 min*, 30 min, 60 min, 3 hour, 6 hour or 12 hour.

*: Default value.

- Procedure to call up the display

| |
|---|
| [Root Menu] → Diag/Service → Test → Test Auto Release Time |
| ----- |
| In case of EJX910 V2.1 (HART 5 DTM) Diag and Service → Service → Test Auto Release Time |

(1) Fixed current output

This feature can be used to output a fixed current for loop checks. The available range for test output depend on the settings for the **AO lower limit** and **AO upper limit** parameters, whose limit is from 3.8mA (-1.25%) to 21.6mA (110%).

Refer to the subsection 3.3.1 about the setting of **AO lower limit** and **AO upper limit**.

While this function works, "TEST" is displayed on the integral indicator.

Call up the test output parameter (Loop test) and select the output signal.

- Procedure to call up the display

| [Root Menu] → Diag/Service → Test → Loop test | |
|---|-----------------------------------|
| Display Item | Contents |
| 4mA | Output a 4mA DC signal |
| 20mA | Output a 20mA DC signal |
| Other | Set a desired output signal value |
| End | Exit |

• In case of EJX910 V2.1 (HART 5 DTM)

Call up the test output parameter (Loop test) and select either manual test or auto test, and set the current value.

- Procedure to call up the display

| Diag and Service → Service → Loop test | |
|--|--|
| Display Item | Contents |
| Manual Test | Set the current value or % value at Test output value , then click the Start button. |
| Auto Test | Set the interval and rate of change of current output at Auto Test Setting , then click the Start button. |

(2) DO Test

This function performs the contact and pulse output test.

- Procedure to call up the display

| [Root Menu] → Detailed setup → Output condition → Process Alerts → DO config → DO Test | |
|--|-------------------------------|
| ----- | |
| In case of EJX910 V2.1 (HART 5 DTM) Diag and Service → Service → DO test | |
| Display Item | Contents |
| Status High | Contact output: OFF |
| Status Low | Contact output: ON |
| Frequency | Frequency range 0 to 10,000Hz |
| Exit | Output test is canceled |

(3) Flow Simulation Mode

The flow value can be calculated by using pseudo values instead of using actual measurements of differential pressure, static pressure, and external temperature.

This is called "flow simulation mode."

The output current value becomes the simulation value and the LCD continuously displays the simulation value and alarm (AL.90 SIM) in alternating sequence.

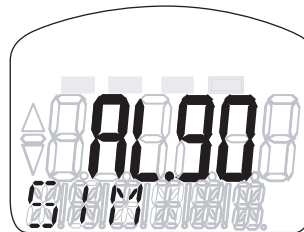

F0308.ai

Select the desired simulation mode from the list below, and set the unit and value.

- Procedure to call up the display

| | | |
|---|--|---|
| [Root Menu] → Detailed setup → Flow Simulation* → | | |
| In case of EJX910 V2.1 (HART 5 DTM) Configuration → Simulation → | | |
| → Simulation Mode (Select the combination of pseudo variables) | Off: | – |
| | ON: DP | Differential pressure only |
| | ON: SP | Static pressure only |
| | ON: DP SP | Differential pressure and static pressure |
| | ON: ET | External temperature only |
| | ON: DP ET | Differential pressure and external temperature |
| | ON: SP ET | Static pressure and external temperature |
| | ON: DP SP ET | Differential pressure, static pressure and external temperature |
| Check Flow Calc | Differential pressure, static pressure, and external temperature without damping | |
| → (Flow) Sim Pres Unit | Select the unit for the differential pressure | |
| → (Flow) Sim Pres | Set the differential pressure value for simulation | |
| It is similar about SP and ET. | | |

*: In previous DD/DTM, "Simulation" is for HART 5, "Flow Simulation" is for HART 7



NOTE

The output process value while simulation can be monitored by LCD and through communication as follows.

| Process value | Output value |
|---------------|--|
| DP | Simulation value according to simulation mode |
| SP | Simulation value according to simulation mode |
| ET | [ET fixed: No, Yes or FALL BACK] Simulation value according to simulation mode. [ET fixed: Saturated Steam] External temperature value calculated from the static pressure value. |
| Flow Rate | Flow calculation value using the DP, SP, ET simulation value |
| Total Flow | Flow Rate accumulation value |

Following function is reflected to flow calculation while simulation.

| Simulation value | Function |
|------------------|--|
| DP/SP/ET | Measuring Range (LRV/URV) Alarm Status Output Damping Time* |
| DP | Low Cut Mode |

*: When "Check Flow Calc" is selected, damping is ignored.

If one of the following alarm occurs while simulation, all of the output data are held to the value before alarm occurs.

- AL.01 (CAP. ERR)
- AL.02 (AMP. ERR)
- AL.03 (ET. ERR)

**(4) Device Variable Simulation Function
(Effective only when setting to HART 7)**

Using the simulation function, the output signal can be confirmed by setting any value and status to the selected device variable.

Call up the parameter and follow the message shown.

After completing the step 5, the simulation starts. Integral indicator shows output and alarm (AL.91) alternately.

- Procedure of device variable simulation

| | | |
|--------|------------------------------|--|
| Step 1 | Call up the parameter | [Root Menu] → Diag/Service → Test → Simulate |
| 2 | Selection of Device Variable | Select one parameter from the list below Off Flow Pres SP ET Total Flow PV SV TV QV % Range Loop Current |
| 3 | Setting of Value | Input the simulate value |
| 4 | Setting of Data quality | Select one parameter from the list below Bad Poor accuracy Manual / Fixed Good |
| 5 | Setting of Limit status | Select one parameter from the list below Not limited Low limited High limited Constant |



NOTE

- The flow rate is calculated from differential pressure, static pressure, and external temperature, and the total flow is accumulated from the flow rate. Therefore, the simulation results for the flow rate and total flow depend on the simulation settings of differential pressure, static pressure, and external temperature. The total flow depends on the flow rate as well.
- The total flow simulation is only applied for LCD display and communication output and does not affect the total flow value.
- All the simulations for differential pressure, static pressure, external temperature, flow rate are reflected to the output. Accordingly, the loop current, LCD display, and communication output are directly corresponded to the simulate value. The alarm output is also available according to the simulate value.
- Damping is applicable for differential pressure, static pressure, and external temperature simulation.

(5) Squawk (Effective only when setting to HART 7)

● **Device Revision 11 or later**

This is used to determine with which transmitter communication is currently taking place. There are two squawk modes; “once” mode in which the squawk display below is shown for 10 seconds and automatically cleared, and “continuous” mode in which the display below will keep showing until “OFF” is input. Follow the procedures to set squawk mode.

- Executing the **Squawk** display

| | |
|--|--|
| [Root Menu] → Diag/Service → Test → Squawk | |
| Continuous | Squawk display will keep showing |
| Once | Squawk display is shown for 10 seconds, and automatically cleared. |

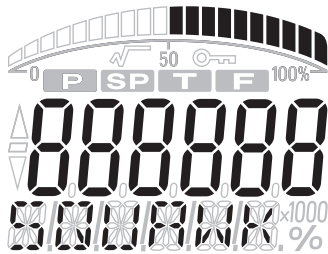

F0309.ai

Figure 3.3 Display during Squawk Execution

● **Device Revision 10**

This feature can be used to identify the communicating transmitter by remotely causing LCD to display the particular pattern as shown in the Figure 3.3.

“SQUAWK” continues for approximately 15 seconds, then is released automatically. Enter the larger number to “Change number of squawks to make” in order to prolong the duration of squawk indication.

3.3.14 Basic Flow Calculation (Basic mode)

In the case of Basic mode, flow operation and density compensation are performed conventionally with the flow factors manually input.

The flow rate is calculated using the constant flow factor.

Density is compensated as follows according to the selection of gas or liquid.

Gas: Compensation as ideal gas by temperature and pressure.

Liquid: Compensation by temperature.

There are an automatic compensation mode and basic mode in the flow calculation, and either is selected in the **Flow Calc Mode** parameter.

- Procedure to call up the display

| [Root Menu] → Detailed setup → Basic Flow Calc → Flow Calc Mode | |
|---|--|
| In case of EJX910 V2.1 (HART 5 DTM) Configuration → Basic Flow Calc → Flow Calc Mode | |
| Display Item | Contents |
| Basic Mode | Basic calculation mode |
| Auto Comp. Mode | Automatic compensation mode (Use FSA120 for this mode) |

Select “Basic Mode” here, and set the parameters according to the procedure of Table 3.2.

FSA120 (FlowNavigator) can configure both automatic compensation mode and basic mode. For detail, refer to the User’s Manual of FSA120 FieldMate FlowNavigator (IM 01C25R51-01E).

Table 3.2 Basic Flow Calc Set-up Steps

| Step | Parameter | Contents | Remarks |
|------|-----------------|---|--|
| 1 | Flow Calc Mode | Select Basic Mode | |
| 2 | Fluid Type | Select liquid or gas | |
| 3 | Flow Calc Fixed | Input Kfactor | Kfactor calculated by Table 3.3 Flow Equation and Kfactor Calculation |
| 4 | Ref SP | Input reference static pressure | This factor is used for gas. When fluid type is liquid, set 0 to Ref SP(Spb). |
| 5 | Ref Temp | Input reference temperature | |
| 6 | Temp K1 | Input the density rate of change per temperature 1degC. | This factor is used for mass flow and normal standard volume flow of liquid. When fluid type is gas or volume flow of liquid, set 0 to TempK1. Refer to Table 3.4 Symbol |

Equation for Basic flow calculation

The flow equation shown in Table 3.3 is applied to the transmitter by combination of fluid type and flow unit category.

Table 3.3 Flow Equation and Kfactor Calculation

| Fluid Type | Flow unit category | Kfactor [In case of orifice] *2 | Flow Equation |
|------------|-----------------------------|---|---|
| liquid | Mass Flow | $Kfactor = \pi/4 \times Nc \times C / \sqrt{1 - \beta^4} \times \epsilon \times d^2 \times \sqrt{2 \times pb}$ | Qm, Qv or Qv_norm $= \underline{Kfactor} \times \sqrt{\Delta p} \times (1 + \underline{Temp K1} \times (T - \underline{Tb}))$ |
| | Normal-Standard Volume Flow | $Kfactor = \pi/4 \times Nc \times C / \sqrt{1 - \beta^4} \times \epsilon \times d^2 \times \sqrt{2 \times pb} / \rho \text{ norm}$ | |
| | Volume Flow | $Kfactor = \pi/4 \times Nc \times C / \sqrt{1 - \beta^4} \times \epsilon \times d^2 \times \sqrt{2} / pb$ | |
| Gas | Mass Flow | $Kfactor = \pi/4 \times Nc \times C / \sqrt{1 - \beta^4} \times \epsilon \times d^2 \times \sqrt{2 \times pb} \times 1/K$ | Qm or Qv_norm $= \underline{Kfactor} \times \sqrt{\Delta p} \times \underline{Tb} / T \times \underline{SP} / \underline{SPb}$ |
| | Normal-Standard Volume Flow | $Kfactor = \pi/4 \times Nc \times C / \sqrt{1 - \beta^4} \times \epsilon \times d^2 \times \sqrt{2 \times pb} \times 1/K / \rho \text{ norm}$ | |
| | Volume Flow | $Kfactor = \pi/4 \times Nc \times C / \sqrt{1 - \beta^4} \times \epsilon \times d^2 \times \sqrt{2} / (pb \times 1/K)$ | Qv = $\underline{Kfactor} \times \sqrt{\Delta p} \times T / \underline{Tb} \times \underline{SPb} / \underline{SP}$ |

*1 == mark indicate user input.

*2 Kfactor must be calculated according to the specified flow unit.

T0310.ai

Table 3.4 Symbol

| No | Symbol | Description |
|----|---------|---|
| 1 | Qm | Mass Flow |
| 2 | Qv | Volume Flow |
| 3 | Qv_norm | Normal-Standard Volume Flow |
| 4 | Nc | Unit convert factor |
| 5 | Kfactor | Basic flow Calculation factor |
| 6 | C | Discharge Coefficient |
| 7 | ε | Expansion Factor |
| 8 | β | Diameter Ratio |
| 9 | d | Diameter of orifice |
| 10 | Δp | Differential Pressure (Transmitter setting unit) |
| 11 | pb | Base Density on Tb, SPb condition |
| 12 | ρ norm | Density on Normal, Standard condition |
| 13 | Tb | Reference temperature (unit: K) |
| 14 | T | Temperature (unit: K) |
| 15 | SPb | Reference static pressure (unit: kPa abs) |
| 16 | SP | Static Pressure (unit: kPa abs) |
| 17 | Temp K1 | The density rate of change per temperature 1degC of a density base value (value which set 100% to 1). For volume flow: set 0. |
| 18 | K | Compressibility factor |

Note 1. The flow unit is not automatically converted. Refer to IM 01C25R01-01E for Nc calculation.

Note 2. Kfactor, SPb, and Tb are calculated using the equipment setting unit (differential pressure, static pressure, and temperature).

Note 3. Total flow is calculated using the transmitter setting unit.

Flow unit category

Table 3.5 Mass Flow Unit

| Unit | LCD | Communication |
|------------------------|--------|---------------|
| grams per second | g/s | ← |
| grams per minute | g/m | g/min |
| grams per hour | g/h | ← |
| Kilograms per second | kg/s | ← |
| kilograms per minute | kg/m | kg/min |
| kilograms per hour | kg/h | ← |
| kilograms per day | kg/d | ← |
| metric tons per minute | t/m | t/min |
| metric tons per hour | t/h | ← |
| metric tons per day | t/d | ← |
| pounds per second | lb/s | ← |
| pounds per minute | lb/m | lb/min |
| pounds per hour | lb/h | ← |
| pounds per day | lb/d | ← |
| short tons per minute | STon/m | STon/min |
| short tons per hour | STon/h | ← |
| short tons per day | STon/d | ← |
| long tons per hour | LTon/h | ← |
| long tons per day | LTon/d | ← |

Table 3.6 Normal/Standard Volume Flow Unit

| Unit | LCD | Communication |
|--------------------------------------|--------|---------------|
| normal cubic meter per hour | Nm3/h | ← |
| normal liter per hour | NL/h | ← |
| standard cubic feet per minute | SCFM | ← |
| standard liter per hour | SL/h | ← |
| standard liter per minute | SL/m | SL/min |
| standard liter per second | SL/s | ← |
| normal cubic meter per day | Nm3/d | ← |
| standard cubic feet per day | SCFD | ← |
| standard cubic feet per hour | SCFH | ← |
| standard cubic feet per second | SCFS | ← |
| standard cubic meter per day | Sm3/d | ← |
| standard cubic meter per hour | Sm3/h | ← |
| thousand standard cubic feet per day | MSCFD | ← |
| million standard cubic feet per day | MMSCFD | ← |

Table 3.7 Volume Flow Unit

| Unit | LCD | Communication |
|-----------------------------|--------|---------------|
| cubic feet per minute | CFM | ← |
| gallons per minute | GPM | ← |
| liters per minute | L/m | L/min |
| imperial gallons per minute | IGal/m | Impgal/min |
| cubic meter per hour | m3/h | ← |
| gallons per second | gal/s | ← |
| million gallons per day | Mgal/d | ← |
| liters per second | L/s | ← |
| million liters per day | ML/d | ← |
| cubic feet per second | CFS | ← |
| cubic feet per day | ft3/d | ← |
| cubic meters per second | m3/s | ← |
| cubic meters per day | m3/d | ← |
| imperial gallons per hour | IGal/h | Impgal/h |
| imperial gallons per day | IGal/d | Impgal/d |
| cubic feet per hour | CFH | ← |
| cubic meters per minute | m3/m | m3/min |
| barrels per second | bbbl/s | ← |
| barrels per minute | bbbl/m | bbbl/min |
| barrels per hour | bbbl/h | ← |
| barrels per day | bbbl/d | ← |
| gallons per hour | gal/h | ← |
| imperial gallons per second | IGal/s | Impgal/s |
| liters per hour | L/h | ← |
| gallons per day | gal/d | ← |

3.3.15 Burst Mode

3.3.15.1 In the case of using HART 5

When the **Burst mode** is enabled, the transmitter continuously sends the stored data. The data is sent approximately three times per second as a digital signal when the transmitter is set in burst mode. When data is being sent in burst mode, other operations can be performed with the HART configuration tool.

(1) Selection of the transmission data.

Call up the **Burst option** parameter and select the data which is transferred.

- Procedure to call up the display

| [Root Menu] → Detailed setup → Output condition → HART output → Burst option | |
|--|--|
| ----- | |
| In case of EJX910 V2.1 (HART 5 DTM) Configuration → HART → Burst option | |
| Display Item | Contents |
| PV | Process variable assigned to PV (Either of differential pressure, static pressure, external temperature, and flow rate) |
| %range/current | Output in % and mA |
| Process vars/crnt | Output in mA and process variables assigned to PV, SV, TV, and 4V. (Output in mA and four variables from differential pressure, static pressure, external temperature, flow rate, and total flow.) |
| Xmtr Variables | Selectable up to four variables from differential pressure, static pressure, external temperature, flow rate, and total flow. According to the procedure indicated in Burst Xmtr Vars, set the selected variables to four Slot. (For the Slot that is not used, set the same value as others.) |

(2) Shift to the Burst mode.

To enable the Burst mode, select “On” at the **Burst mode** parameter.

To release the **Burst mode**, call up the **Burst mode** display and set it to “Off”.

This parameter is set to “Off” when the instrument is shipped.

- Procedure to call up the display

| [Root Menu] → Detailed setup → Output condition → HART output → Burst mode | |
|--|----------------------|
| ----- | |
| In case of EJX910 V2.1 (HART 5 DTM) Configuration → HART → Burst mode | |
| Display Item | Contents |
| Off | Stop the burst mode |
| On | Start the burst mode |

3.3.15.2 In the case of using HART 7

When the **Burst mode** is enabled, the transmitter continuously sends up to three data listed in Table 3.8.

Refer to the subsection 3.3.15.2.1 Burst Message for details.

In case of using HART 7 Burst communication, use Burst Message 1 with following setting;

| Item | Parameter | Setting |
|---------------------|------------------------|--------------------------------|
| Update period | Set Burst Period | 0.5 s (Default) |
| Trigger mode | Burst Msg Trigger Mode | Continuous (Default) |
| Start of Burst mode | Burst mode | Wired HART Enabled or Burst ON |

When the **Burst mode** is set to “Wired HART Enabled (or Burst ON)”, transmitter continuously sends alarm signal also.

Refer to subsection 3.3.15.2.2 Event Notification for detail.

When changing the setting of **Burst mode**, set “Off (or Burst OFF)” to the **Burst mode**.
Default setting is “Off”.

3.3.15.2.1 Burst Message and Burst Mode

(1) Burst message

EJX multivariable transmitter can transmit three burst messages at the maximum.

The parameters for **Burst Message** are as follows.

- Burst Command
- Update Period and Max Update Period
- Burst Msg Trigger Mode

Table 3.8 Burst parameters

| Command parameter | Burst Command | Burst Msg Trigger Mode | Burst Trigger Source | Burst Trigger Units |
|--|--|------------------------|------------------------|--|
| PV (Either of differential pressure, static pressure, external temperature, flow rate) | Cmd1:PV | Continuous | --- | --- |
| | | Window | PV | Depend on the assigned variable to PV |
| | | Rising | | |
| | | Falling | | |
| On-change | | | | |
| % range/current (Percent of range, Loop current) | Cmd2:% range/current | Continuous | --- | --- |
| | | Window | % range | % |
| | | Rising | | |
| | | Falling | | |
| On-change | | | | |
| Process vars/current (Loop current, PV, SV, TV, QV) | Cmd3:Dyn vars/current | Continuous | --- | --- |
| | | Window | PV | Depend on the assigned variable to PV |
| | | Rising | | |
| | | Falling | | |
| On-change | | | | |
| Process vars/% range/ current with status ^{*1} (Select up to eight variables from differential pressure, static pressure, external temperature, flow rate, total flow, percent of range, loop current, PV, SV, TV and QV) ^{*2} | Cmd9:Device vars w/Status | Continuous | --- | --- |
| | | Window | Top of Burst Variables | Depends on mapping |
| | | Rising | | |
| | | Falling | | |
| On-change | | | | |
| Process vars/% range/ current (Select up to four variables from differential pressure, static pressure, external temperature, flow rate, total flow, percent of range, loop current, PV, SV, TV, and QV) ^{*2} | Cmd33:Device Variables | Continuous | Top of Burst Variables | Depend on the assigned variable to Burst Variables |
| | | Window | | |
| | | Rising | | |
| | | Falling | | |
| On-change | | | | |
| Self diagnosis information | Cmd48:Read Additional Device Status | Continuous | --- | --- |
| | | On-change | All status | --- |

*1: Output the data with time and status.

*2: Select at **Burst Variables**

(2) Burst mode setting procedure

- Procedure to call up the display

[Root Menu] → Detailed setup → Output condition → HART output → Burst Condition → Burst Message 1, 2 or 3 → Burst Command

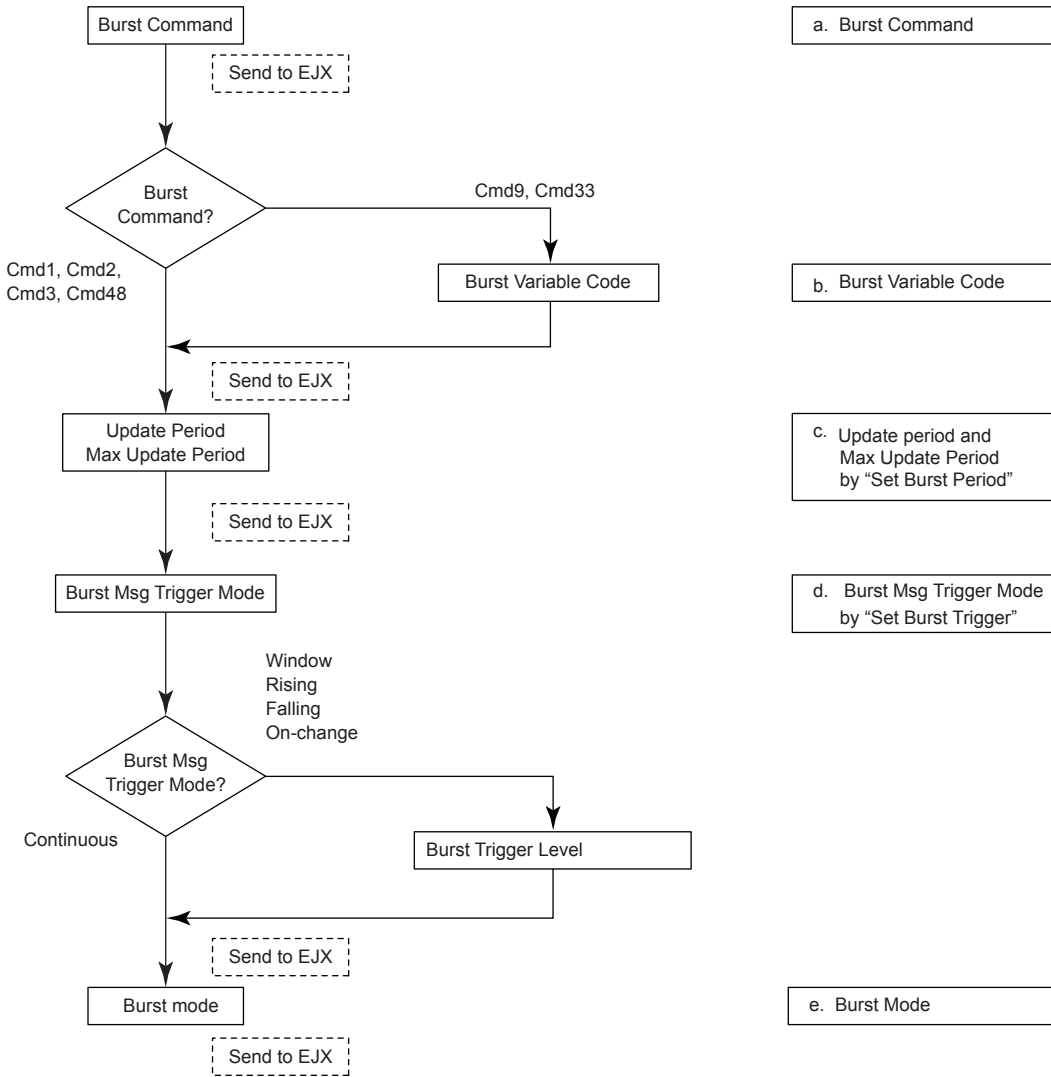

F0311.ai

a. Burst Command

Select the transmission data at **Burst Command** parameter.

| Burst Command | Command parameter |
|--------------------------------------|---|
| Cmd1: PV | Variable assigned to PV |
| Cmd2: % range/current | % range/current (Percent of range, Loop current) |
| Cmd3: Dyn vars/current | Process vars/current (Loop current, PV, SV, TV, QV) |
| Cmd9: Device vars w/Status | Process vars/% range/current Mapping by user |
| Cmd33: Device Variables | Process vars/% range/current Mapping by user |
| Cmd48: Read Additional Device Status | Self diagnosis information |

b. Burst Variable Code

This parameter need to be set when **Burst Command** is Cmd9:Device vars w/Status (up to eight items) and Cmd33: Device Variables (up to four items).

- Procedure to call up the display

[Root Menu] → Detailed setup → Output condition → HART output → Burst Condition → Burst Message 1, 2 or 3 → Burst Variables → Burst Variable Code

| Display Item | Contents |
|--------------|----------------------------------|
| Flow | Select the flow rate |
| Pres | Select the differential pressure |
| SP | Select the static pressure |
| ET | Select the external temperature |
| Total Flow | Select the total flow |
| PV | Select the PV value |
| SV | Select the SV value |
| TV | Select the TV value |
| QV | Select the QV value |
| % rng | Select the % output |
| Loop current | Select the output current |
| Not Used | — |

c. Update period and Max Update Period

Set to **Update Period** and **Max Update Period**. When the period that is earlier than the operation period of each process value was set, it is set automatically to become bigger than an operation period of EJX multivariable transmitter. For **Update Period**, set the value that is smaller than **Max Update Period**.

- Procedure to call up the display

[Root Menu] → Detailed setup → Output condition → HART output → Burst Condition → Burst Message 1, 2 or 3 → Set Burst Period →

| | |
|---------------------|--------|
| → Update Period | 0.5 s |
| / Max Update Period | 1 s |
| | 2 s |
| | 4 s |
| | 8 s |
| | 16 s |
| | 32 s |
| | 1 min |
| | 5 min |
| | 10 min |
| | 15 min |
| | 30 min |
| | 45 min |
| | 60 min |

d. Burst Msg Trigger Mode

Set the **Burst Msg Trigger Mode** from the parameters shown below.

When **Burst Msg Trigger Mode** is Window, Rising or Falling, set the **Burst Trigger Level**.

- Procedure to call up the display

[Root Menu] → Detailed setup → Output condition → HART output → Burst Condition → Burst Message 1, 2 or 3 → Set Burst Trigger

| Display Item | Contents |
|--------------|---|
| Continuous | Burst Message is transmitted continuously. |
| Window | In “Window” mode, the Trigger Value must be a positive number and is the symmetric window around the last communicated value. |
| Rising | In “Rising” mode, the Burst Message must be published when the source value exceeds the threshold established by the trigger value. |
| Falling | In “Falling” mode, the Burst Message must be published when the source value fall below the threshold established by the trigger value. |
| On-change | In “On-change” mode, the Burst Message must be published when the source value on change established by the trigger value. |

e. Burst Mode

When the **Burst mode** is set to “Wired HART Enabled (or Burst ON)”, the transmitter starts to send the data.

- Procedure to call up the display

[Root Menu] → Detailed setup → Output condition → HART output → Burst Condition → Burst Message 1, 2 or 3 → Burst mode → Wired HART Enabled (or Burst ON)



IMPORTANT

In case of using HART 7 Burst communication, use Burst Message 1 in following settings:

| Contents | Menu | Value |
|---------------------------|------------------------|--------------------------------|
| c) Update Period | Set Burst Period | 0.5 s (Default) |
| d) Burst Msg Trigger Mode | Burst Msg Trigger Mode | Continuous (Default) |
| e) Burst mode | Burst mode | Wired HART Enabled or Burst ON |

3.3.15.2.2 Event Notification

When a setting change and a change of the Self-diagnostics occur, device detect it as an event and can transmit an alarm signal continuously.

Up to four events that occurred can be stored.

When using this function, set to **Burst mode** as “Wired HART Enabled (or Burst ON)”.

- * This subsection is explained by the DTM parameter name of the device revision 12. If you are using any other setting tool, please replace it with the corresponding parameter name from the menu tree.

(1) Set Event Notification

- Procedure to call up the display

| | |
|--|---|
| [Root Menu] → Detailed setup → Output condition → HART output → Event Notification → | |
| → Event Mask | Set the status to detect |
| → Event Condition → | Set the event monitor condition → |
| → Set Event Notification Timing | Set the retry time when the event occur. |
| → Control | Stop the monitor: Off Shift to the monitor state: Enable event notification on token-passing data link layer |

a) Event Mask

Set the status to detect in the **Event Mask** parameter.

| |
|--------------------------------|
| Device Status Mask |
| Status group 1 Mask to 11 Mask |
| Ext dev status Mask |
| Diagnostic Status 0 Mask |

b) Event Notification Retry Time/ Max Update Time/ Debounce Interval

Set to Retry Time, Max Update Time and Debounce Interval.

For **Retry Time**, set the value that is smaller than **Max Update Time**.

| Retry Time /Max Update Time | Debounce Interval |
|-----------------------------|-------------------|
| --- | Off |
| 0.5 s | 0.5 s |
| 1 s | 1 s |
| 2 s | 2 s |
| 4 s | 4 s |
| 8 s | 8 s |
| 16 s | 16 s |
| 32 s | 32 s |
| 1 min | 1 min |
| 5 min | 5 min |
| 10 min | 10 min |
| 15 min | 15 min |
| 30 min | 30 min |
| 45 min | 45 min |
| 60 min | 60 min |

c) Event Notification Control

Select “Enable event notification on token-passing data link layer” in the **Control** parameter to shift to the monitor state:

(2) Acknowledge Event Notification

The transmission of the event message stops when event is approved.

- Procedure to call up the display

| | |
|--|---|
| [Root Menu] → Detailed setup → Output condition → HART output → Event Notification → Knowledge → | |
| → Acknowledge Event Notification | Acquisition of the event number and approval. |

a) Get Event Number

Confirm the latest event number.

Execute **Acknowledge Event Notification** method.

- 1) Enter Event Number is set to "0".
- 2) OK.
- 3) Set "Trans 0: Read Event Notificaiton" to Select Transaction.
- 4) OK.
- 5) Confirm Event Number.

b) Acknowledge Event Notification

Execute **Acknowledge Event Notification** method.

- 1) Set to Enter Event Number is in confirmed Event Number a)5.
- 2) OK.
- 3) Set "Trans 1: Send Acknowledge" to Select Transaction.
- 4) OK.
- 5) Confirm Event Status is 0x00.

(3) Event Notification Record

- Procedure to call up the display

| | |
|--|---|
| [Root Menu] → Detailed setup → Output condition → HART output → Event Notification → Knowledge → | |
| → Acknowledge Event Notification | Acquisition of the event number and approval. |

a) Get Event Number

Confirm the latest event number.

Execute **Acknowledge Event Notification** method.

- 1) Enter Event Number is set to "0".
- 2) OK.
- 3) Set "Trans 0: Read Event Notificaiton" to Select Transaction.
- 4) OK.
- 5) Confirm Event Number.

b) Confirmation record of Event Notification

Confirm four events checked in a).

Execute **Acknowledge Event Notification** method.

- 1) Enter the event number to Enter Event Number which is confirmed in a)5.
- 2) OK.
- 3) Set "Trans 0: Read Event Notificaiton" to Select Transaction.
- 4) OK.
- 5) Knowledge menu displays events record.

Ex.) When the confirmed event number is 123.

| Event Number | Explanation |
|--------------|------------------------------|
| 123 | The latest event |
| 122 | An event before the once. |
| 121 | An event before the twice. |
| 120 | An event before three times. |

3.3.16 Multidrop Mode

3.3.16.1 In the case of using HART 5

"Multidropping" transmitters refer to the connection of several transmitters to a single communication transmission line. Up to 15 transmitters can be connected when set in the multidrop mode. To activate multidrop communication, the transmitter address must be changed to a number from 1 to 15. This change deactivates the 4 to 20 mA analog output, sending it to 4 mA. The alarm current is also disabled.

Setting of Multidrop Mode

(1) Polling address

- Procedure to call up the display

| | |
|---|-------------------------------|
| [Root Menu] → Detailed setup → Output condition → HART output → | |
| ----- | |
| In case of EJX910 V2.1 (HART 5 DTM) Configuration → HART → | |
| → Poll addr | Enter the number from 1 to 15 |

(2) Enabling the Multidrop Mode

About the procedure to call up the **Polling** display, please refer to the User's Manual of each configuration tool.



NOTE

When the same polling address is set for two or more transmitters in multidrop mode, communication with these transmitters is disabled.

(3) Communication when set in multidrop mode.

- The HART configuration tool searches for a transmitter that is set in multidrop mode when it is turned on. When the HART configuration tool is connected to the transmitter, the polling address and the tag will be displayed.

- Select the desired transmitter. After that, normal communication to the selected transmitter is possible. However, the communication speed will be slow.

To release multidrop mode, call up the **Poll addr** display and set the address to “0”.

3.3.16.2 In the case of using HART 7

“Multidropping” transmitters refer to the connection of several transmitters to a single communication transmission line. Up to 63 transmitters can be connected when set in the multidrop mode. To activate multidrop communication, the transmitter address must be changed to a number from 1 to 63. This change deactivates the 4 to 20 mA analog output, sending it to 4 mA. The alarm current is also disabled.

Setting of Multidrop Mode

(1) Polling address

- Procedure to call up the display

| | |
|---|-------------------------------|
| [Root Menu] → Detailed setup → Output condition → HART output → | |
| → Poll addr | Enter the number from 1 to 63 |

(2) Enabling the Multidrop Mode

About the procedure to call up the **Polling** display, please refer to the User’s Manual of each configuration tool.

When **Loop current mode** is set to “Enabled”, an analog signal output is available for one device in a loop.

- Procedure to call up the display

| | |
|---|--------------------------------|
| [Root Menu] → Detailed setup → Output condition → Analog output → Loop current mode | |
| Enabled | Loop current mode is enabled. |
| Disabled | Loop current mode is disabled. |



NOTE

When the same polling address is set for two or more transmitters in multidrop mode, communication with these transmitters is disabled.

(3) Communication when set in multidrop mode.

- The HART configuration tool searches for a transmitter that is set in multidrop mode when it is turned on. When the HART configuration tool is connected to the transmitter, the polling address and the tag will be displayed.
- Select the desired transmitter. After that, normal communication to the selected transmitter is possible. However, the communication speed will be slow.

To release multidrop mode, call up the **Poll addr** display and set the address to “0”.

3.3.17 Switching HART Protocol Revision

When the output signal code is “-J”, HART protocol revision of EJX multivariable transmitter can be selectable from 5 or 7.

The HART protocol revision is set and shipped as specified in the order.

To change the HART protocol revision after shipment, follow the procedure shown below.



IMPORTANT

When changing the protocol revision, confirm the items below.

- Protocol revision supported by HART configuration tool must be the same or higher than new protocol revision of the EJX multivariable transmitter. (Refer to Table 2.1)
- Confirm that the DD or DTM which is suitable to new protocol revision of EJX multivariable transmitter is installed in the configuration tool. (Refer to Section 2.3 or 2.4)

- 1) Call up the parameter for protocol revision change
 - Procedure to call up the **Chg universal rev** display.

| |
|--|
| [Root Menu] → Detailed setup → Device information → Field device info → Revision #'s → Chg universal rev |
| ----- |
| In case of EJX910 V2.1 (HART 5 DTM) Configuration → HART → Chg universal rev |

- 2) Activate the “Chg universal rev” method



IMPORTANT

The message is displayed to separate the transmitter from the automatic control loop. Confirm that the transmitter is separated.

- 3) Input the new revision number
An input column for new protocol revision number is displayed.
Input the new HART protocol revision number of "5" for HART 5 or "7" for HART 7.
- 4) Applying the new protocol revision
 - a. Close the configuration tool
After completion of Chg universal rev method, close the HART configuration tool.



NOTE

When using a FieldMate, close the main display of FieldMate.

- b. Restart the transmitter
Turn off the power to the transmitter, and turn it on.



IMPORTANT

New protocol revision is applied only after having performed restart of the transmitter.



NOTE

A new HART revision number is displayed on the integral indicator for three (3) seconds after restart the transmitter. (Refer to section 2.1)

- 5) Confirming the new protocol revision
 - a. Restart the HART configuration tool



NOTE

When execute the other parameter confirmation or setting change, execute after restart the configuration tool.

- b. Confirm the new HART protocol revision number

Call up the **Universal rev** parameter, and confirm that the new HART revision number is displayed.

- Procedure to call up the **Universal rev** parameter.

| | |
|--|---------------------------|
| [Root Menu] → Detailed setup → Device information | |
| → Field device info → Revision #'s → Universal rev | |
| ----- | |
| In case of EJX910 V2.1 (HART 5 DTM) | |
| Configuration → HART → Universal rev. | |
| 5 | HART protocol revision: 5 |
| 7 | HART protocol revision: 7 |

4. Diagnostics

4.1 Self-Diagnostics

4.1.1 Identify Problems by Using the HART Configuration Tool

The HART configuration tool can be used to run self-diagnostics on a transmitter and check for incorrect data settings.

The **Self test** and **Status** commands are available for self-diagnostics. When **Self test** is run, the integral indicator shows an error code and alarm message if the transmitter detects any illegal parameter settings or functional faults. See Table 4.5 Alarm Message Summary for probable cause and countermeasures.

- Procedure to call up the **Self test** display

[Root Menu] → Diag/Service → Test → Self test

If no error is detected, “Self test OK” is displayed on the configuration tool.

If the specific diagnostic item is known for the check, you can directly call up the item by using the **Status** command.

The status is categorized from 1 to 10 for HART 5, and from 1 to 11 for HART 7.

See Table 4.5 to determine the status group.

Show an example below to confirm the status of Status group 1.

- Procedure to call up the **Status** display

[Root Menu] → Diag/Service → Status → Status group 1

If no error is detected, “Off” is displayed on the configuration tool.

If there is an error, “On” is displayed on the configuration tool, and a countermeasure for that error is necessary.

| | | |
|---------------------|-----------------|-----|
| Example of display: | Illegal P LRV | On |
| | Illegal P URV | Off |
| | Illegal P SPAN | Off |
| | P SPAN trim err | Off |
| | P ZERO trim err | Off |

The HART configuration tool diagnoses at each communication.

When an improper operation is performed, the error message is displayed.

See Table 4.6 HART Configuration Tool Error Message.

- Using EJX910 V2.1 (HART 5 DTM)

The **Device Status** commands are used for self-diagnostics. When **Device Status** is run, the integral indicator shows an error code and alarm message if the transmitter detects any illegal parameter settings or functional faults. See Table 4.5 Alarm Message Summary for probable cause and countermeasures.

- Procedure to call up the **Device Status** display

Device Status

If no error is detected, “Status: Normal” is displayed on the configuration tool.

If the specific diagnostic item is known for the check, you can directly call up the item by using the Diagnostic List in the Device Status display.

The Diagnostic List is categorized to Device Status, Hardware Failure, Transducer Status, Diag Status, and Configuration.

See Table 4.5 Alarm Message Summary.

If no error is detected, color symbol which shows Normal State is displayed on top of the error message.

If color symbol which shows Error State is displayed, there is an error and a countermeasure for that error is necessary.

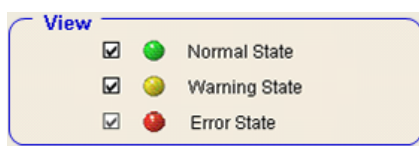
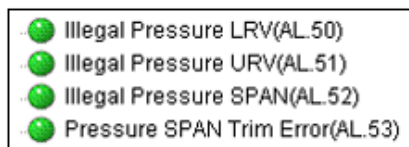

The HART configuration tool diagnoses at each communication.

When an improper operation is performed, the error message is displayed.

See Table 4.6 HART Configuration Tool Error Message.

4.1.2 Checking with Integral Indicator



NOTE

If an error is detected by running self-diagnostics, an error number is displayed on the integral indicator. If there is more than one error, the error number changes at three-second intervals. See table 4.3.1 regarding the alarm codes.



F0401.ai

Figure 4.1 Integral Indicator

4.1.3 Status information available for HART 7

Status added to HART 7 is explained below.

(1) Device Status

Device Status indicates the current operating status of the device. (Refer to Table 4.7)
Table 4.10 indicates the relationship between alarm and Device Status.

- Procedure to call up the display

[Root Menu] → Diag/Service → Status → Device Status

(2) Extended Device Status

Ext dev status contains commonly used device information. (Refer to Table 4.8)
Table 4.10 indicates the relationship between alarm and Extended Device Status.

- Procedure to call up the display

[Root Menu] → Diag/Service → Status → Ext dev status

(3) Data quality and Limit status

EJX multivariable transmitter can handle Dynamic Variables (PV, SV, TV, QV) and Device Variables (DP(Pres), SP, ET, Flow, Total Flow, % range, Loop current). Each variable contains data quality and limit status for providing useful status about the data value. The data quality is normally “Good”. However, in the case of a sensor failure or out of measurement range, it turns to “Bad” or “Poor Accuracy”. The limit status indicates whether the data value is limited (i.e., not responding to the process). When the limit status is “Constant”, the value will not be changed. For detail, refer to Table 4.9 and 4.10.

- Procedure to call up the display

[Dynamic Variables]

| | |
|--|---|
| [Root Menu] → Process variables → Output vars → PV → | |
| → PV Data Quality | Good, Poor Accuracy, Manual/Fixed, or Bad is displayed. |
| → PV Limit Status | Constant, Low Limit, High Limit, or Not Limited is displayed. |
| It is the same about the SV, TV, and QV. | |

[Device Variables]

| | |
|---|---|
| [Root Menu] → Process variables → Device variables and Status → | |
| → Flow Data Quality | Good, Poor Accuracy, Manual/Fixed, or Bad is displayed. |
| → Flow Limit Status | Constant, Low Limit, High Limit, or Not Limited is displayed. |
| It is the same about the Pres, SP, ET, Total Flow, % Range, and Loop Current. . | |

(4) Time Stamp

Time Stamp displays the date and the time information which EJX multivariable transmitter maintains from the time of the power on. It is used as the additional information of the process value and the event.

- Procedure to call up the display using DD (HART 7) and DTM (HART 7)

| | |
|--|--|
| [Root Menu] → Diag/Service → Status → Time Stamp → | |
| → Current Date | It shows the number of operating days. |
| → Current Time | It shows the running time. |



NOTE

Time Stamp is reset when powering on.

- (5) Configuration Change Counter
The Configuration Change Counter is incremented once for every user action that changes the device's configuration or calibration. This value is never reset or written and maintained even if power is removed from the device.

- Procedure to call up the display

| | |
|--|--|
| [Root Menu] → Diag/Service → Status → | |
| → Cfg chng count | The configuration change times are counted. The counted value cannot be reset. |

- (6) Reset Configuration Changed Flag
Configuration Changed Flag can be reset by this method.



NOTE

Refer to Configuration Changed (0x40) in the Table 4.7.

- Procedure to call up the display

| |
|--|
| [Root Menu] → Diag/Service → Status → Reset Cfg Chng flag |
|--|

4.2 Advanced Diagnostics

4.2.1 Multi-sensing Process Monitoring

Multi-sensing process monitoring function (option code: /DG6) provides the advanced diagnostics to detect the abnormal conditions in process environment such as an impulse line etc. by using the EJX multisensing technology and its unique algorithm. There are following two functions.

■ Impulse Line Blockage Detection (ILBD)

The fluctuation change of differential pressure and static pressure is monitored by a silicone resonant sensor and detects a potential blockage condition. The differential pressure transmitter gives also a result of which pressure-side was plugged.

■ Heat Trace Monitoring

The two temperature sensors built in the EJX multivariable transmitter calculate the flange temperature, the change of which enables to detect the heat trace breakage or the abnormal temperature due to the failure.

4.2.2 Impulse Line Blockage Detection (ILBD)

ILBD is carried out by using statistical analysis based on the measured values of process fluctuations that exist in a fluid. An alarm on the EJX multivariable transmitter LCD display or an analog alert is generated if blockage reaches a certain level. EJX multivariable transmitter provides the following results as blockage detection.

- (1) A Blocking and B Blocking
These are blockage detections based on the fluctuation value change of differential pressure/pressure. With a differential pressure transmitter, each result indicates that both or single side is plugged.
 - (2) L Side Blocking
It is a low-pressure side blockage detection based on the change of **BIkF** or low-pressure-side fluctuation value.
 - (3) H Side Blocking
It is a high-pressure side blockage detection based on the change of **BIkF** or high-pressure-side fluctuation value.
- *: **BIkF** indicates blockage degree characterized by a comparison of the high- and low-pressure-side fluctuation values. For the details, refer to Figure 4.2.2.



IMPORTANT

- The pressure fluctuation amplitude in fluids must be sufficiently large for blockages to be detected.
- If the pressure fluctuation amplitude is too low for a reference value to be obtained, blockages detection operation cannot be performed with an alarm that the reference value is invalid.
- The pressure fluctuation amplitude may decrease due to other causes unrelated with a blockage according to process condition. In above case, a false alarm of an impulse line blockage may be generated. Before taking action in response to a blockage alarm, consider the plant operating conditions.

■ Notes for Pressure or Level Measurement

With pressure or level measurement, the pressure fluctuation amplitude may reduce especially for the following cases.

● Pressure Measurement

- Operational pressure is near outside of diagnostic range.
- Even though pressure is constant, the flow decreases than that under normal condition.
- A source of pressure fluctuation (pump, compressor, blower, etc.) is shut down. As a result, the pressure fluctuation amplitude decreases.

● Level Measurement

- A transmitter is used to measure tank level and the flow of fluid into or out of the tank comes to a stop.
- The agitator in the tank is shut down.
- A source of pressure variation (a compressor, etc.) that controls the internal pressure of a sealed (closed) tank is shut down.

Before taking action in response to a blockage alarm, consider the plant operating conditions.

■ Functional block diagram

The figure below shows the functional block diagram of ILBD.

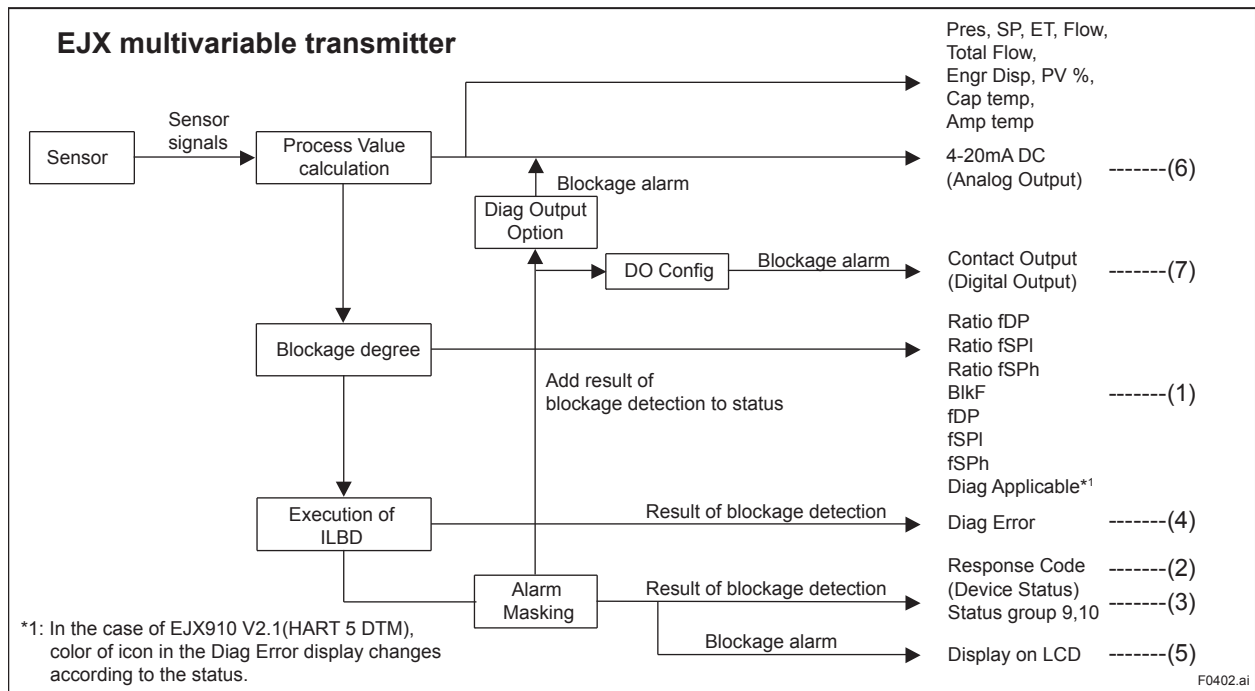

Figure 4.2 Functional Block Diagram of ILBD

The following outputs are given for the ILBD results.

Table 4.1 List of Outputs for ILBD

| # | OUTPUT Parameter name | Remarks |
|-----|-----------------------------|--|
| (1) | Ratio fDP | Parameters based on the fluctuation value and blockage degree. [Diag DPComp: Non-Compensation] $\text{Ratio fDP} = \sqrt{\frac{\text{fDP}}{\text{Ref fDP}}}$ [Diag DPComp: Compensation] $\text{Ratio fDP} = \sqrt{\frac{\text{fDP}}{\text{Ref fDP}}} \times \left \frac{\text{Ref DPAvg}}{\text{DPAvg}} \right $ |
| | Ratio fSPI | $\text{Ratio fSPI} = \sqrt{\frac{\text{fSPI}}{\text{Ref fSPI}}}$ |
| | Ratio fSPh | $\text{Ratio fSPh} = \sqrt{\frac{\text{fSPh}}{\text{Ref fSPh}}}$ |
| | BlkF | Blockage degree characterized in comparison of high-pressure side and low-pressure side pressure fluctuation value. |
| | fDP | Average value of the sum of squares of differential pressure fluctuations. |
| | fSPI | Average value of the sum of squares of low-pressure side static pressure fluctuation. |
| | fSPh | Average value of the sum of squares of high-pressure side static pressure fluctuation. |
| | Diag Applicable*1 | After the reference value is obtained, the applicable blockage deflection and the status of abnormal fluctuation are displayed on this parameter. |
| (2) | Response Code Device Status | When an impulse line blockage is detected, "More Status Available" is generated in Response Code Device Status. |
| (3) | Status group 9,10 | When an impulse line blockage is detected, the result of the blockage detection (alarm status) is indicated. |
| (4) | Diag Error | When an impulse line blockage is detected, the results of the blockage detection (alarm status) is indicated. |
| (5) | Display on LCD | When impulse line blockage is detected, an alarm status is displayed on LCD. |
| (6) | Analog Output | When impulse line blockage is detected, an alarm status is output on 4 to 20mA. |
| (7) | Digital Output | When impulse line blockage is detected, an alarm status is output on Status output. |

*1: In the case of EJX910 V2.1(HART 5 DTM), color of icon in the Diag Error display changes according to the status.

4.2.2.1 Blockage Detection

■ Limit parameter

When the parameter based on pressure fluctuation exceeds the preset value, EJX diagnoses an impulse line as blockage and gives an alarm. The threshold values are set to Limit parameter shown in below table.

- Procedure to call up the display

[Root Menu] → Diag/Service → Diag Parameters → ILBD Parameters → Configuration → Diag Lim →

 In case of EJX910 V2.1 (HART 5 DTM)
 Diag and Service → Advanced Diag Configurations → Impulse Line Blockage Detection → Threshold → Sensitivity →

Table 4.2 Limit Parameter

| # | Parameter | Threshold value |
|------|--------------|--|
| [1] | Lim fDPmax | Threshold to detect "A Blocking" by using Ratio fDP |
| [2] | Lim fDPmin | Threshold to detect "B Blocking" by using Ratio fDP |
| [3] | Lim fSPImax | Threshold to detect "Large Fluct L" by using Ratio fSPI |
| [4] | Lim fSPImin | Threshold to detect "L Side Blocking" by using Ratio fSPI |
| [5] | Lim fSPHmax | Threshold to detect "Large Fluct H" by using Ratio fSPH |
| [6] | Lim fSPHmin | Threshold to detect "H Side Blocking" by using Ratio fSPH |
| [7] | Lim BlkFmax | Threshold to detect "H Side Blocking" by using BlkF |
| [8] | Lim BlkFmin | Threshold to detect "L Side Blocking" by using BlkF |
| [9] | Lim DPavgmax | Threshold to detect "ILDB over range" by using DPavg and to detect "Invalid Ref xx" by using Ref DPavg |
| [10] | Lim DPavgmin | Threshold to detect "ILDB over range" by using DPavg and to detect "Invalid Ref xx" by using Ref DPavg |

Table 4.3 shows the default values at the factory setting.



NOTE

- When ILBD is performed for the first time, use the default value. If the pressure fluctuation amplitude is low or a false alarm is often generated after ILBD is performed, change the values of Limit parameters according to the procedure described in subsection 4.2.2.10. Tuning

Table 4.3 Default Values of Limit Parameter

| # | Parameter | Multivariable Transmitter |
|------|---------------------------------------|---------------------------|
| | | EJX910A, EJX930A |
| [1] | Lim fDPmax | 3 |
| [2] | Lim fDPmin | 0.3 |
| [3] | Lim fSPImax | 5 |
| [4] | Lim fSPImin | 0.5 |
| [5] | Lim fSPHmax | 5 |
| [6] | Lim fSPHmin | 0.5 |
| [7] | Lim BlkFmax | 0.6 |
| [8] | Lim BlkFmin | -0.6 |
| [9] | Lim DPavgmax <small>Note 1</small> | 1 |
| [10] | Lim DPavgmin <small>Note 1</small> | 0.05 |

Note 1: It indicates the threshold value for "ILDB over range" (refer to subsection 4.2.2.5).

■ A/B Blocking Detection

"A Blocking" and "B Blocking" indicates the result estimated from blockage degree based on the difference of the high- and low-pressure-side fluctuation values. **Ratio fDP**, $\text{SQRT}(\text{fDP} / \text{Ref fDP})$ is used to detect A/B blocking. **Ref fDP** is the average value of the sum of squares of differential pressure fluctuations under normal condition.

As the value of **Ratio fDP** exceeds the value of **Lim fDPmax**, EJX gives basically an alarm of "A Blocking". On the other hand, if this value is below the value of **Lim fDPmin**, EJX gives an alarm of "B Blocking".

As a high- or low-pressure-side blockage progresses, **fDP** increases. Therefore, "A Blocking" with a differential pressure transmitter indicates that a single-side impulse line is plugged for a differential pressure transmitter. As the both-side blockages progress simultaneously, **fDP** decreases. Therefore, "B Blocking" with a differential pressure transmitter indicates that both-side impulse lines are plugged.



NOTE

A single-side impulse line blockage may generate "B blocking" under the condition where the fluctuation amplitude is much different between high- and low-pressure sides.

■ **H/L Blocking Detection**

EJX differential pressure transmitter enables to detect both-, a high-, or low-pressure-side blockage. The blockage degree characterized by a comparison of high-pressure side and low-pressure-side fluctuation values, **BlkF**, is used to detect it. The value changes within a range of -1 to +1. As **BlkF** approaches +1, the high-pressure-side blockage progresses. On the other hand, if it approaches -1, the low-pressure-side blockage progresses.

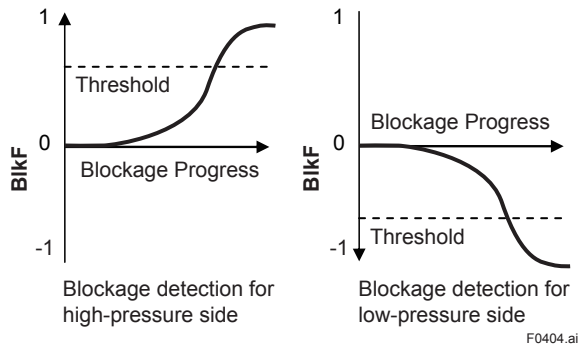

Figure 4.3 Relation between Blockage Progress and BlkF

The each threshold value to detect the high- or low-pressure-side blockage is set to **Lim BlkFmax** or **Lim BlkFmin**.

■ **L Side Blocking Detection**

BlkF is preferentially used to "L Side Blocking" detection. If **BlkF** cannot be used, **Ratio fSPI**, $\text{SQRT}(fSPI / \text{Ref } fSPI)$ is used to "L Side Blocking" detection. **Ref fSPI** is the average value of the sum of squares of low-pressure-side static pressure fluctuations under normal condition.

As the value of **Ratio fSPI** is below the value of **Lim fSPImin**, EJX gives an alarm of "L Side Blocking".

On the other hand, if this value exceeds the value of **Lim fSPImax**, EJX gives an alarm of "Large Fluct L".

■ **H Side Blocking Detection**

BlkF is preferentially used to "H Side Blocking" detection. If **BlkF** cannot be used, **Ratio fSPH**, $\text{SQRT}(fSPH / \text{Ref } fSPH)$ is used to "H Side Blocking" detection. **Ref fSPH** is the average value of the sum of squares of high-pressure-side static pressure fluctuations under normal condition.

As the value of **Ratio fSPH** is below the value of **Lim fSPHmin**, EJX gives an alarm of "H Side Blocking".

On the other hand, if this value exceeds the value of **Lim fSPHmax**, EJX gives an alarm of "Large Fluct H".

■ **Large Fluctuation Detection**

When a pump or compressor starts, the large fluctuation is generated as process condition changes rapidly. This phenomenon affects process fluctuation measurement; so correct blockage detection is not performed.

If "Large Fluct L" or "Large Fluct H" is detected, consider whether a blockage result is correct.

The threshold values to detect large fluctuation are set to **Lim fSPImax** and **Lim fSPHmax**.

Since these values are enough to detect large fluctuation, it is not almost necessary to change them.

4.2.2.2 Combination of Reference Result and Blockage Detection

■ Diag Applicable

An EJX multivariable transmitter can detect four modes of impulse line blockage: both-sides, high-pressure side, low-pressure side, and/or single-side and abnormal fluctuation when all the reference values are properly measured. However, the detectable alarm mode combination is limited when some of the reference values are invalid. Available Blockage Detection are shown in the below figure.



NOTE

- **Ref fDP** must be larger than the specified level shown in Table 4.4 (refer to subsection 4.2.2.6). No blockage can be detected when **Ref fDP** is not large enough.
- The plausibility of blockage detection needs to be confirmed by blockage simulation test. The simulation test can be performed by the appropriate manifold operation (refer to subsection 4.2.2.8).

[Differential pressure measurement]

| Fluctuation Parameters | Simulation Test | Available Blockage Detection |
|---|---|--|
| Ref fDP: OK Ref fSPI: OK Ref fSPH: OK Ref BlkF: OK | • Test for low-pressure side • Test for high-pressure side • Test for both-pressure sides | • B Blocking detection (by using Ratio fDP) • L Side Blocking detection (by using Ratio fSPI) • H Side Blocking detection (by using Ratio fSPH) • H/L Side Blocking detection (by using BlkF) |
| Ref fDP: OK Ref fSPI: OK Ref fSPH: OK Ref BlkF: NG | • Test for low-pressure side • Test for high-pressure side • Test for both-pressure sides | • A/B Blocking detection (by using Ratio fDP) • L Side Blocking detection (by using Ratio fSPI) • H Side Blocking detection (by using Ratio fSPH) |
| Ref fDP: OK Ref fSPI: NG Ref fSPH: OK Ref BlkF: NG | • Test for high-pressure side | • A Blocking detection (by using Ratio fDP) • H Side Blocking detection (by using Ratio fSPH) |
| Ref fDP: OK Ref fSPI: NG Ref fSPH: NG Ref BlkF: NG | • Test for both-pressure sides | • B Blocking detection (by using Ratio fDP) |

[Gauge/absolute pressure and level measurement]

| Fluctuation Parameters | Simulation Test | Available Blockage Detection |
|------------------------|-------------------------------|---|
| Ref fDP: OK | • Test for high-pressure side | • B Blocking detection (by using Ratio fDP) |

F0405.ai

4.2.2.3 Operation Parameters

■ Diag Mode

Diag Mode gives the directive for the ILBD operation. There are following three modes.

- Procedure to call up the display

[Root Menu] → Diag/Service → Diag Parameters → ILBD Parameters → Configuration → (Configuration →) Set Diag Mode →

 In case of EJX910 V2.1 (HART 5 DTM)
 Diag and Service → Advanced Diag Configurations → Impulse Line Blockage Detection → Diag Mode →

Diag Mode

| Mode | Function |
|-------------|--|
| Stop | The blockage detection operation is stopped. |
| Calculation | The blockage detection operation is performed. Alarms are generated along with the result. |
| Reference | Reference values for the blockage detection are obtained and updated to the latest. After sampling reference values, this mode changes to "Calculation". |

When the blockage detection operation is performed, set "Calculation" to **Diag Mode**. "Stop" must be set when you change a threshold value or set an alarm. "Reference" is set in order to obtain the reference fluctuation values under the normal configuration.



NOTE

When setting ILBD parameters in the transmitter via "Online Parameter" of the EJX910 V2.1 (HART 5 DTM) menu, Diag Mode automatically changes to 0 (Stop). After the setting, Diag Mode automatically returns to the original value.



NOTE

When setting ILBD parameters in the transmitter via "Download to device" of the EJX910 V2.1 (HART 5 DTM) menu, Diag Mode automatically changes to 0 (Stop).

■ Diag Period

The values such as **Ratio fDP** and **BlkF** are averaged based on several hundreds of pressure fluctuation values in constant time. **Diag Period** defines the sampling time is. The default value at the shipment is set to 180 sec.

- Procedure to call up the display

[Root Menu] → Diag/Service → Diag Parameters → ILBD Parameters → Configuration → (Configuration →) Diag Period

 In case of EJX910 V2.1 (HART 5 DTM)
 Diag and Service → Advanced Diag Configurations → Impulse Line Blockage Detection → Diag Period

For the information on how to change the sampling period, refer to subsection 4.2.2.10.

■ Diag Supp Count

When the value as **Ratio fDP** or **BlkF** exceeds the threshold value for several times in a row, it is estimated that the impulse line is plugged.

Diag Supp Count defines the number of times to estimate blockage detection.

- Procedure to call up the display

[Root Menu] → Diag/Service → Diag Parameters → ILBD Parameters → Configuration → (Configuration →) Diag Supp Count

 In case of EJX910 V2.1 (HART 5 DTM)
 Diag and Service → Advanced Diag Configurations → Impulse Line Blockage Detection → Threshold → Diag Suppress Count

If **Diag Supp Count** is set to three times, an alarm is not generated at part 'A' in Figure 4.4. Because the first and second values only exceeded consecutively the threshold.

When the value exceeds consecutively the threshold value three times, an alarm is generated (see part 'B' in Figure 4.4).

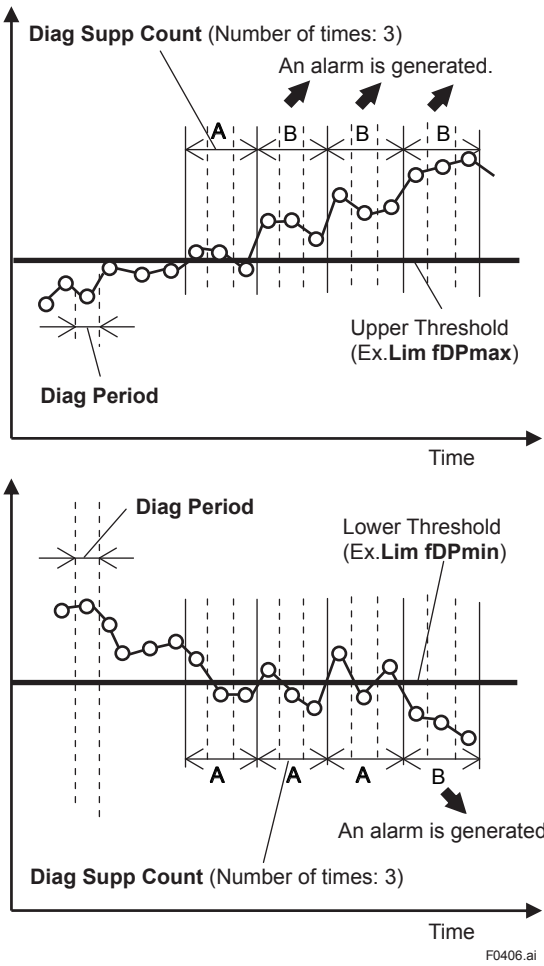

Figure 4.4 Relationship of Diag Supp Count and Alarm

The number of detection to give an alarm is set for each blockage detection function. The default value at the shipment is set to three times.

If fluctuating around the threshold value, an alarm may be often generated. In this case, change the threshold value (Limit parameter) or the sampling time (Limit parameter) or the sampling time (**Diag Period**) to enhance the accuracy of the blockage detection. Refer to subsection 4.2.2.10.

4.2.2.4 Operating Procedure

The basic flow of the ILBD operation is as follows.

- 1) Initial setting
- 2) Condition check
- 3) Start up
- 4) Perform the ILBD algorithm.

If an alarm is often generated or the process condition changed in the ILBD operation, do tuning to change the alarm setting, or to reset the reference values.

Fill out the information to the checklist, at the process shown in below figure.
(Refer to the Appendix 1. ILBD Check List)

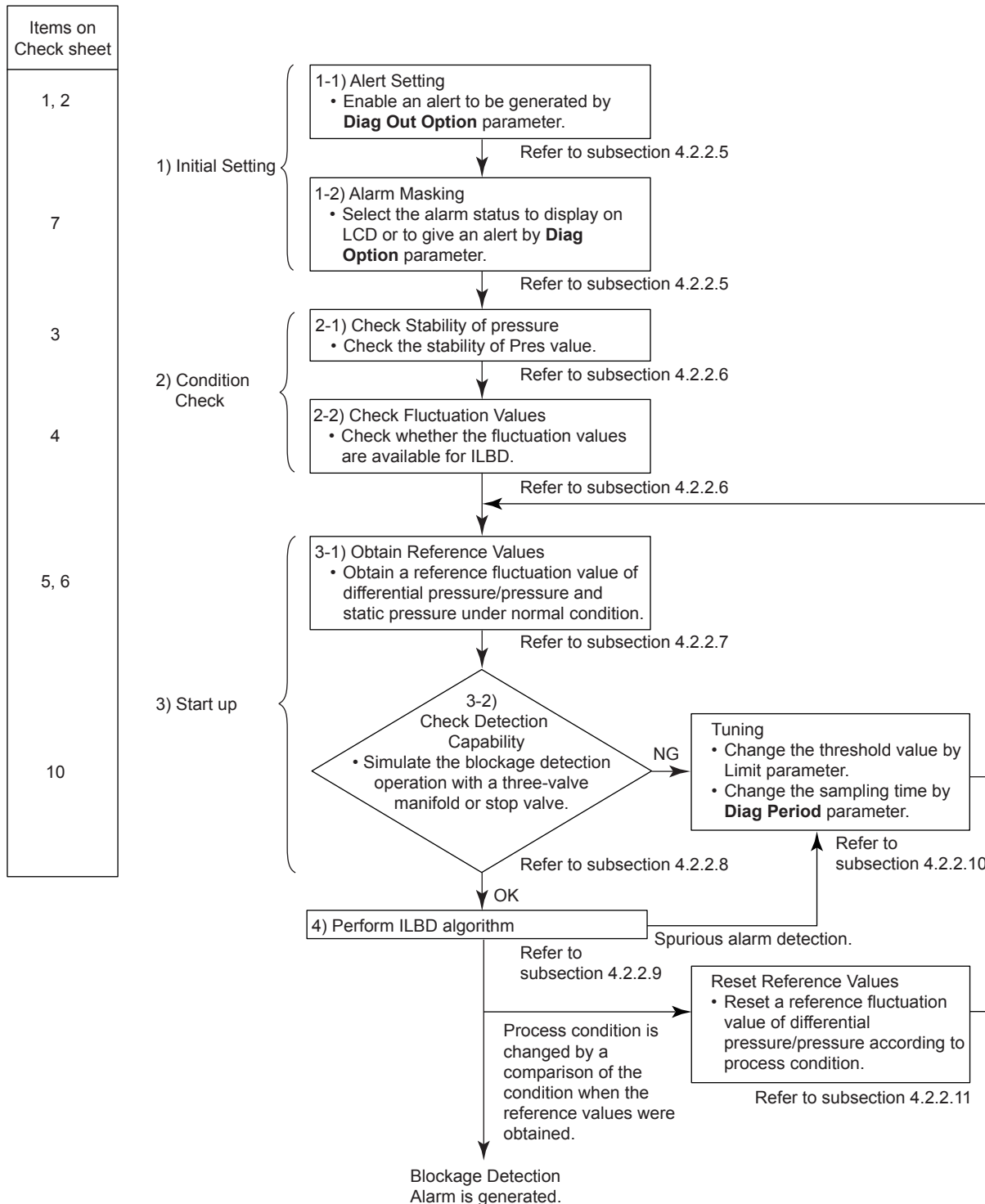

F0407.ai

Figure 4.5 Flow Chart of ILBD Operation

4.2.2.5 Alarm and Alert Setting

The abnormal results as the blockage detection and high/low flange temperature (heat trace monitoring) are given through an analog alert or the LCD display of alarm status. Before performing the ILBD operation, it is necessary to set the alarm and alert according to the following procedure.

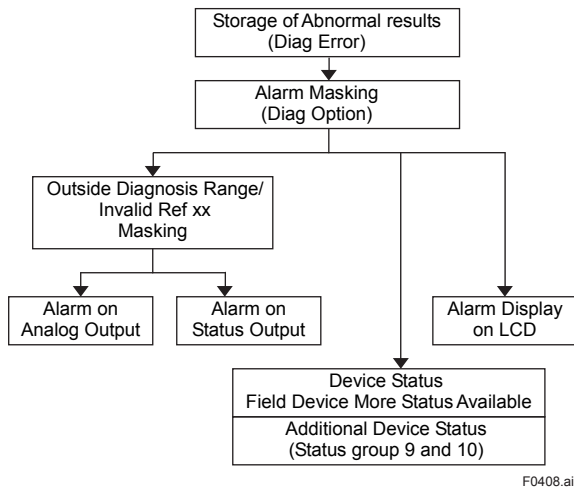

Figure 4.6 Alarm and Alert Setting

■ Alarm Status

When the algorithm of ILBD and Heat trace monitoring detect the abnormality, the result is stored in **Diag Error**. The alarm status based on the detected abnormality is displayed to **Diag Error**.

(Displayed to **Impulse Line Blockage Detection** and **Heat Trace** for EJX910 V2.1 (HART 5 DTM))

- Procedure to call up the display

[Root Menu] → Diag/Service → Diag Parameters → Diag Error

 In case of EJX910 V2.1 (HART 5 DTM)
 Diag and Service → Advanced Diag Alerts → Diag Error

| Bit | Expect EJX910 V2.1 (HART 5 DTM) | EJX910 V2.1 (HART 5 DTM) | Category |
|-----|---------------------------------|--------------------------------|-----------------------|
| 0 | Not used | Not used | |
| 1 | Not used | Not used | |
| 2 | A Blocking | A Blocking | ILBD |
| 3 | Large Fluct L | Large Fluctuation of Low Side | |
| 4 | Large Fluct H | Large Fluctuation of High Side | |
| 5 | L Side Blocking | Low Side Blocking | |
| 6 | H Side Blocking | High Side Blocking | |
| 7 | B Blocking | B Blocking | |
| 8 | Invalid Ref F | Invalid Ref BkF | |
| 9 | Invalid Ref SPH | Invalid Ref fSPH | |
| 10 | Invalid Ref SPL | Invalid Ref fSPL | |
| 11 | Invalid Ref DP | Invalid Ref fDP | |
| 12 | ILBD over range | Outside Diagnosis Range | |
| 13 | FT low alarm | Flg Temp Low Alarm | Heat trace monitoring |
| 14 | FT high alarm | Flg Temp High Alarm | |
| 15 | Not used | Not used | |

Note: FT indicates the flange temperature.

● ILBD over range (Outside Diagnosis Range)

- Procedure to call up the display

[Root Menu] → Diag/Service → Diag Parameters → ILBD Parameters → Configuration → Diag Lim →

 In case of EJX910 V2.1 (HART 5 DTM)
 Diag and Service → Advanced Diag Configurations → Impulse Line Blockage Detection → Threshold → Sensitivity →

1) Lim DPavgmax

Lim DPavgmax is the upper limit of the diagnostic capability range. The limit value can be changed when **Diag Mode** is "Stop".

DPavg indicates the ratio of the average of differential pressure to the EJX maximum span regarded as 1. When **DPavg** exceeds this limit, "ILBD over range" is generated so that the blockage detection becomes impossible.

2) Lim DPavgmin

Lim DPavgmin is the lower limit of the diagnostic capability range. The limit value can be changed when **Diag Mode** is "Stop".

When **DPavg** is below this limit, "ILBD over range" is generated so that the blockage detection becomes impossible.

<Example>

When the level range that can be measured by the transmitter with 100 kPa span is -80 to 80 kPa, the limits are set as follows.

- **Lim DPAvgmax:** 0.80
- **Lim DPAvgmax:** -0.80

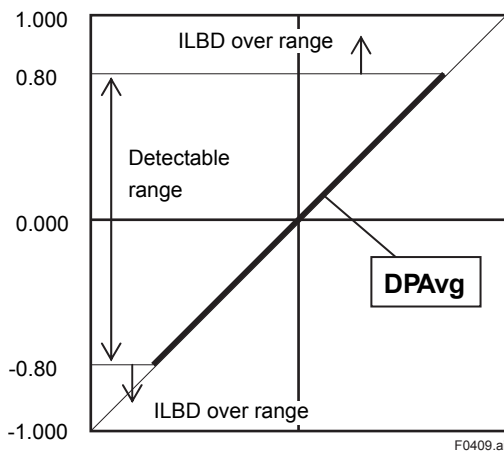

● **Invalid Ref F, SPH, SPL, or DP**

This alarm indicates that the reference value under normal condition is invalid. If **Ref F** is invalid, the blockage detection excluding **BIkF** is carried out. If blockage detection function based on **BIkF** is required, obtain the reference value again.

Also when **Ref DPAvg** is below **Lim DPAvgmin** or exceeds **Lim DPAvgmax**, all reference value becomes invalid so that “Invalid Ref DP”, “Invalid Ref SPL”, “Invalid Ref SPH”, and “Invalid Ref F” are generated.

■ **Alarm Masking**

● **Diag Option**

The alarms linked to an analog alert and LCD display are selected by **Diag Option**.

- Procedure to call up the display

[Root Menu] → Diag/Service → Diag Parameters → Diag Option

 In case of EJX910 V2.1 (HART 5 DTM)
 Diag and Service → Advanced Diag Configurations → Impulse Line Blockage Detection → Alarm Notification (Diag Option)

The bit of **Diag Option** is corresponding to that of **Diag Error**. The following alarms are set at the factory setting, which is corresponding to hexadecimal 0x08FC.

| Expect EJX910 V2.1 (HART 5 DTM) | EJX910 V2.1 (HART 5 DTM) |
|---------------------------------|--------------------------------|
| A Blocking | A Blocking |
| Large Fluct L | Large Fluctuation of Low Side |
| Large Fluct H | Large Fluctuation of High Side |
| L Side Blocking | Low Side Blocking |
| H Side Blocking | High Side Blocking |
| B Blocking | B Blocking |
| Invalid Ref DP | Invalid Ref fDP |

To Link the alarm to an analog alert and LCD display, follow the procedure below.

- 1) Set “Stop” to **Diag Mode**.
- 2) Check each checkbox of the alarm, which is selectable from bit 2 to 14.

Note: Set to “Calculation” after setting the parameter.

■ **Alert Setting**

● **Diag Out Option**

When an alert regarding the impulse line blockage or high/low flange temperature is generated, the output value of 4-20 mA analog signal can be changed.

| Mode | Function |
|-----------|---|
| Off | Keeping PV measurement. The alert is not reflected to 4-20 mA analog signal. |
| Burnout | The analog signal is shifted to the value of AO upper limit or AO lower limit when an alert is generated. The shifted direction follows Burnout switch setting. |
| Fall back | The analog signal is hold to the specific value, Diag Fixed Out Val , when an alert is generated. |

- Procedure to call up the display

[Root Menu] → Diag/Service → Diag Parameters → Diag Output → Diag Out Option

 In case of EJX910 V2.1 (HART 5 DTM)
 Diag and Service → Advanced Diag Configurations → Diag Output → Diag Out Option

■ **Diag Fixed Out Val**

This parameter is used when “Fall back” is selected to **Diag Output Option**.

When an alert is generated, the 4-20 mA analog signal is held on the value specified by this parameter.

The value can be entered within 3.8 to 21.6 mA.

- Procedure to call up the display

[Root Menu] → Diag/Service → Diag Parameters →
 Diag Output → Diag Fixed Out Val

 In case of EJX910 V2.1 (HART 5 DTM)
 Diag and Service → Advanced Diag Configurations →
 Diag Output → Diag Fixed Out Val

● **Status Output for Advanced diagnostic**

The output of the abnormal results are applicable for a transistor output (open collector) of an on/off signal according to the status of high and low alarm limits, which are values set to Limit parameters as shown in subsection 4.2.2.1. About the **Flg temp Hi Alert Val**, or **Flg temp Lo Alert Val** for Heat trace monitoring, refer to subsection 4.2.3.2.

■ **DO Select**

If the advanced diagnostic function is installed, the following modes can be also assigned to the status output in addition to Pres, SP, Temp and Flow.

| Mode | Function |
|------------|--|
| Diag Alarm | The status regarding advanced diagnostic masked by Diag Option is output. |
| All | All status of Press, SP, Temp, Flow and advanced diagnostic are output. |

■ **Alarm Display on LCD**

If the ILBD algorithm detects the abnormality, the content of the detected result is displayed with “AL.88” or “AL.89” on the LCD. “AL.88” indicates that condition is not applicable for the abnormality detection and “AL.89” indicates the abnormality is detected.

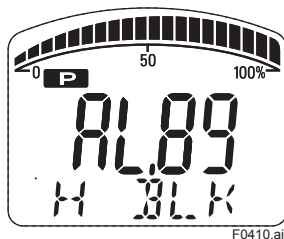

Figure 4.7 Display Example of H Side Blocking

The alarm display on LCD regarding the advanced diagnostic is described in Table 4.5.

NOTE

The alarms of “Invalid Ref xx” and “ILBD over range” do not link to the 4-20 mA analog signal and Status output.

4.2.2.6 **Condition Check**

After the EJX multivariable transmitter was installed, it is necessary to confirm if **Pres** is stable under the normal operating condition or if fluctuation amplitude under the normal operating condition is large enough to detect the blockage.

■ **Stability of Pressure Value**

- 1) Observe the value change of **Pres** under the normal operating condition for 10 minutes.
- 2) Confirm the value change is less than 10%.

- Procedure to call up the display

[Root Menu] → Detailed setup → Sensors → Pres
 Configuration → Process Input → Pres

If the value change is more than 10%, the error influences pressure fluctuation value so that the blockage detection becomes impossible. Consider the plant operating conditions.

■ **Fluctuation Value**

NOTE

The blockage detection may not be carried out correctly when pressure fluctuation amplitude especially with the pressure and level measurement, is small.

Confirm that each value of **fDP**, **fSPI**, **fSPH**, and **BlkF** is more than the value specified in the below table.

- Procedure to call up the **fDP**, **fSPI**, **fSPH** display

[Root Menu] → Diag/Service → Diag Parameters →
 ILBD parameters → Status → Fluct Variables → fDP/
 fSPI/fSPH

 In case of EJX910 V2.1 (HART 5 DTM)
 Diag and Service → Advanced Diag Variables → fDP/
 fSPI/fSPH

- Procedure to call up the **BlkF** display

[Root Menu] → Diag/Service → Diag Parameters →
 ILBD parameters → Status → Diag Variables → BlkF

 In case of EJX910 V2.1 (HART 5 DTM)
 Diag and Service → Advanced Diag Variables → BlkF

Table 4.4 Requirements to apply ILBD

| | Condition |
|-------------|-----------------------------|
| fDP | 7×10^{-10} or more |
| fSPI | 1×10^{-10} or more |
| fSPH | 1×10^{-10} or more |
| BlkF | -0.5 to 0.5 |

● **fDP is not enough.**

No blockage can be detected if **fDP** is not larger than the specified value.

● **Only fDP is enough.**

“A Blocking” or “B Blocking” can be detected if **fSPI** and **fSPh** are not larger than specified values.

● **fDP and fSPI are enough.**

“H Side Blocking” and “Large Fluct H” can not be detected if **fSPh** is not larger than specified value.

● **fDP and fSPh are enough.**

“L Side Blocking” and “Large Fluct L” can not be detected if **fSPI** is not larger than specified value.

● **fDP, fSPI and fSPh are enough.**

All alarm modes can be detected even if **BlkF** is not within the specified values.

4.2.2.7 Obtain Reference Values

The pressure fluctuation values are reduced when the impulse line is plugged. Therefore, the reference value is required to determine the degree of reduction.



IMPORTANT

- If the impulse line is about to be plugged at the time when a reference value is obtained, blockages cannot be detected accurately. The impulse lines on both the high-pressure and low-pressure sides need to be cleaned before a reference value is obtained.
- All air bubbles need to be adequately purged before a reference value is obtained.
- Reference values must be obtained under operating condition.

■ **Start of Sampling**

The sampling of reference value is carried out for 180 sec, which is the default value set to **Diag Period**.

- 1) Confirm that the sampling period (**Diag Period**) is set to 180 sec.
- 2) Set “Reference” to **Diag Mode**.
The sampling starts soon after the setting.



IMPORTANT

- For the each parameter, the one value is given. If Reference is set to **Diag Mode** again, the value is updated and overwritten.
- If the power supply is shut down during the sampling, **Diag Mode** becomes “Stop”. Set “Reference” to **Diag Mode** in order to carry out the sampling again.

■ **End of Sampling**

After about 180 sec, the sampling automatically finishes. The “Reference” setting of **Diag Mode** moves automatically to “Calculation”.

Confirm that the setting of **Diag Mode** moves to “Calculation”.

■ **Reference Values**

Confirm the latest values are obtained into the following parameters.

- Ref fDP
- Ref fSPI
- Ref fSPh
- Ref BlkF
- Ref DPavg

- Procedure to call up the display

| |
|--|
| <p>[Root Menu] → Diag/Service → Diag Parameters → ILBD parameters → Status → Diag Reference → Ref fDP/Ref fSPI/Ref fSPh/Ref BlkF/Ref DPavg</p> <hr/> <p>In case of EJX910 V2.1 (HART 5 DTM) Diag and Service → Advanced Diag Configurations → Impulse Line Blockage Detection → Ref fDP/Ref fSPI/Ref fSPh/Ref BlkF/Ref DPavg</p> |
|--|

■ Invalid Ref F, SPH, SPL, or DP

When the enough reference fluctuation value is not obtained, an alarm of invalid reference value for each parameter is generated and also the ILBD operation is not carried out.

Confirm the alarm of **Invalid Ref F, SPH, SPL, or DP** is not displayed in **Diag Error**.

If an alarm of **Invalid Ref F, SPH, SPL, or DP** is generated, consider the process condition or obtain the reference fluctuation values again.



NOTE

Even if an alarm of **Invalid Ref F, SPH, SPL, or DP** is generated, "Calculation" in **Diag Mode** is kept.

4.2.2.8 Capability Test of Blockage Detection Operation

Before performing the ILBD operation, check the capability of the blockage detection operation. The simulation test is performed by closing motion of a three-valve manifold or stop valve. When simulated blockage occurs, confirm that an alarm is generated.



NOTE

The fluctuation amplitude of atmospheric pressure is nearly zero with pressure or level measurement. In such case, simulate the blockage detection by closing the valve where the fluctuation existed.

■ Simulation of High-pressure Side Blockage

- 1) Close the high-pressure-side valve.
- 2) Confirm the value of **Pres** is stable. If not, open the valve a little.
- 3) Set "Calculation" to **Diag Mode** so as to start blockage detection operation.
- 4) Check that an alarm of "H Side Blocking" is generated after the time that consists of **Diag Period** and **Diag Supp Count** passed.
- 5) Check also the operation of the analog alert if an analog alert is set.
- 6) Open the valve completely and check that there are no alarms.

■ Simulation of Low-pressure Side Blockage

- 1) Close the low-pressure-side valve.
- 2) Confirm the value of **Pres** is stable. If not, open the valve a little.
- 3) Set "Calculation" to **Diag Mode** so as to start blockage detection operation.
- 4) Check that an alarm of "L Side Blocking" is generated after the time that consists of **Diag Period** and **Diag Supp Count** passed.
- 5) Check also the operation of the analog alert if an analog alert is set.
- 6) Open the valve completely and check that there are no alarms.

■ Simulation of Both-pressure Side Blockage

- 1) Close the both-pressure-side valves.
- 2) Confirm the value of **Pres** is stable. If not, open the valve a little.
- 3) Set "Calculation" to **Diag Mode** so as to start blockage detection operation.
- 4) Check that an alarm of "B Blocking" is generated in the **Diag Error** after the time that consists of **Diag Period** and **Diag Supp Count** passed.
- 5) Check also the operation of the analog alert if an analog alert is set.
- 6) Open the valve completely and check that there are no alarms.

4.2.2.9 Start ILBD Operation

If process condition and capability to detect a blockage are confirmed, you can start the ILBD operation according to the following procedure.

- 1) Check the value of sampling period (**Diag Period**).
- 2) Check the number of times that detect the blockage consecutively in order to give an alarm (**Diag Supp Count**). The default value at the shipment is set to 3 times.
- 3) Set "Calculation" to **Diag Mode**.
If the reference value has not yet been obtained, set "Reference" to **Diag Mode**. After obtained the reference values, the ILBD starts automatically. At the same time, **Diag Mode** changes automatically from "Reference" to "Calculation".

4.2.2.10 Tuning

When the pressure fluctuation amplitude in fluids is not sufficiently large or an alarm is often generated according to the process condition, tune up by changing the threshold for the blockage detection (Limit parameters) or the sampling period (**Diag Period**) to enhance the accuracy of the blockage detection. The ILBD operation must be stopped to tune up. Set "Stop" to **Diag Mode**.

■ Threshold Value

The figure below shows the image of tuning effect with a monochrome bar.

- (a) The tuning image of the threshold values for
 - (1) **Ratio fDP**: $\text{Sqrt}(\text{fDP}/\text{Ref fDP})$,
 - (2) **Ratio fSPI**: $\text{Sqrt}(\text{fSPI}/\text{Ref fSPI})$,
 - (3) **Ratio fSPH**: $\text{Sqrt}(\text{fSPH}/\text{Ref fSPH})$

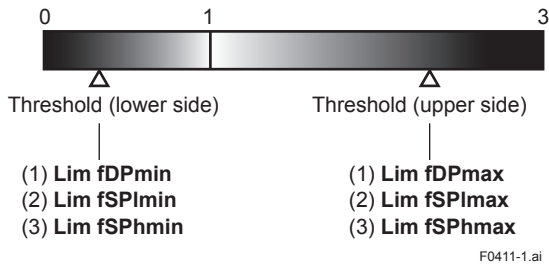

- (b) The tuning image of the threshold values for
 - (4) $\text{Sqrt}(\text{BlkF}/\text{Ref BlkF})$

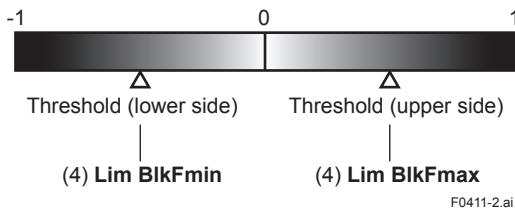

Figure 4.8 Tuning Image of Threshold Value

● Move the threshold toward the white.

- It becomes increasingly likely to give a false alarm due to the disturbance from environment change.
- If flow/differential pressure is below **Lim DPavgmin** or exceeds **Lim DPavgmax**, pressure fluctuation is likely too small or too large to detect the blockage.

● Move the threshold toward the black.

- It enables to be insusceptible to disturbance such as environment change and to detect the blockage easier.
- It becomes giving an alarm of the blockage after the blockage has been progressed.

- Procedure to call up the **threshold** related display

[Root Menu] → Diag/Service → Diag Parameters → ILBD parameters → Configuration → Diag Lim →

The default values at the factory setting are the values of **Lim fDPmax** to **Lim BlkFmin** shown in Table 4.3.

Change the threshold value to solve your problem according to the above image.

- 1) Set "Stop" to **Set Diag Mode**.
- 2) Change the unsuitable value of **Diag Lim** parameters corresponding to the each blockage detection.

Note: Set to "Calculation" after setting the parameter.

Limit parameter

| # | Parameter | Threshold value |
|-----|-------------|--|
| [1] | Lim fDPmax | Threshold to detect "A Blocking" by using Ratio fDP |
| [2] | Lim fDPmin | Threshold to detect "B Blocking" by using Ratio fDP |
| [3] | Lim fSPImax | Threshold to detect "Large Fluct L" by using Ratio fSPI |
| [4] | Lim fSPImin | Threshold to detect "L Side Blocking" by using Ratio fSPI |
| [5] | Lim fSPHmax | Threshold to detect "Large Fluct H" by using Ratio fSPH |
| [6] | Lim fSPHmin | Threshold to detect "H Side Blocking" by using Ratio fSPH |
| [7] | Lim BlkFmax | Threshold to detect "H Side Blocking" by using BlkF |
| [8] | Lim BlkFmin | Threshold to detect "L Side Blocking" by using BlkF |

- In case of EJX910 V2.1 (HART 5 DTM) Combination of threshold depend on the sensitivity of blockage detection can be selected from High, Medium, or Low in the **Sensitivity** parameter.

- Procedure to call up the display

Diag and Service → Advanced Diag Configurations → Impulse Line Blockage Detection → Threshold → Sensitivity

When select "Custom" in the Sensitivity parameter, you can set each threshold individually. Set the **Diag Mode** to "Stop" before changing the threshold.

Combination of threshold for sensitivity parameter

| | High | Medium | Low |
|-------------|-------|--------|-------|
| Lim fDPmax | 1.50 | 3.00 | 3.00 |
| Lim fDPmin | 0.40 | 0.30 | 0.20 |
| Lim fSPImax | 5.00 | 5.00 | 5.00 |
| Lim fSPImin | 0.50 | 0.50 | 0.30 |
| Lim fSPHmax | 5.00 | 5.00 | 5.00 |
| Lim fSPHmin | 0.50 | 0.50 | 0.30 |
| Lim BlkFmax | 0.60 | 0.60 | 0.80 |
| Lim BlkFmin | -0.60 | -0.60 | -0.80 |

■ **Sampling Period**

If fluctuating around the threshold value, an alarm maybe often generated. When the above phenomenon happens, the sampling time (**Diag Period**) can be changed so as to enhance the accuracy of the blockage detection.

The longer the sampling time, better the expected accuracy.

- (1) Set "Stop" to **Diag Mode**.
- (2) Enter the value to **Diag Period** within the range of 20 to 65535 (sec).

Note: Set to "Calculation" after setting the parameter.

Also, the accuracy can be improved by increasing the number of **Diag Supp Count**.

■ **ILBD Range Setting**

If flow/differential pressure is less than the default threshold value of **Lim DPAvgmin**, pressure fluctuation is not large enough to detect the blockage. To prevent the fault blockage detection, the threshold should be changed to larger value.

- (1) Set "Stop" to **Diag Mode**.
- (2) Enter the value to **Lim DPAvgmin** or **Lim DPAvgmax**.

Note Set to "Calculation" after setting the parameter.

- Procedure to call up the **threshold** display

[Root Menu] → Diag/Service → Diag Parameters → ILBD parameters → Configuration → Diag Lim →

 In case of EJX910 V2.1 (HART 5 DTM)
 Diag and Service → Advanced Diag Configurations → Impulse Line Blockage Detection → Threshold →

■ **Ratio fDP Compensation**

When the flow change is too large or small, an alarm maybe often generated. When the above case happens, the Ratio fDP can be compensated so as to enhance the accuracy of the blockage detection.

● **Diag DPComp**

When "Compensation" is selected in **Diag DPComp**, **Ratio fDP** is compensated by following formula and used as treatable monitoring value, **CRatio fDP**.

$$CRatio\ fDP = \sqrt{\frac{fDP}{Ref\ fDP}} \times \left| \frac{Ref\ DPAvg}{DPAvg} \right|$$

On the other hand, if the compensation is not necessary, "Non-compensation" is selected in **Diag DPComp** and **Ratio fDP** is used as **NRatio fDP**.

$$NRatio\ fDP = \sqrt{\frac{fDP}{Ref\ fDP}}$$

- Procedure to call up the display

[Root Menu] → Diag/Service → Diag Parameters → ILBD parameters → Status → Diag Variables →

 In case of EJX910 V2.1 (HART 5 DTM)
 Diag and Service → Advanced Diag Variables →

4.2.2.11 **Reset of Reference Value**

When there are large flow change or the change of fluid conditions, obtain the reference value again. If flow change by a comparison of the reference value is ±25% or more, obtain the reference value again.

4.2.2.12 ILBD Parameter List

| # | Parameter name | Default value | Explanation |
|----|--------------------|---------------|--|
| 1 | Diag Error | 0x0000 | The results detected by ILBD or Heat trace monitoring are stored into this parameter. Also the condition abnormality in the diagnostic process is stored as an error. |
| 2 | Diag Option | 0x08FC | The masking in this parameter enable to display each error message and the status to the output signal or LCD. The error assigned to each bit is corresponding to that of Diag Error . Writable only when Diag Mode is "Stop". |
| 3 | Diag Out Option | Off | Output mode of 4-20mA when an advanced diagnostic alarm is generated. There are following three output modes; Off, Burnout, or Fall back. |
| 4 | Diag Fixed Out Val | 21.6 mA | Parameter for "Fall back" function in the Diag Out option. The output value of 4-20 mA analog signal is specified when an alarm is generated. The value can be entered within 3.8 to 21.6 mA. |
| 5 | DO Select | Off | The variables for status output are specified to this parameter. When the advanced diagnostic function (option code /DG6) is installed, the parameters monitoring in diagnostic process can be also assigned to the status output. |
| 6 | Diag Mode | Stop | The operation mode of ILBD is set. Stop: The blockage detection is stopped. Calculate: The blockage detection is carried out. The alarms are generated along with the detected result. Reference: The reference values are obtained and the update values are overwritten. After setting, this mode moves automatically to "Calculation". |
| 7 | Diag Period | 180 (sec) | The data acquisition period for ILBD is set within 20 to 65535 (sec). If the process fluctuation values are unsteady, this value is changed to the longer to enhance the accuracy of the blockage detection. Writable only when Diag Mode is "Stop". |
| 8 | Diag Supp Count | 3 | Detection count to generate an alarm. When the statistical value as Ratio fDP and BlkF exceeds consecutively the threshold by number of times preset to this parameter, it is estimated that the impulse line is plugged. |
| 9 | Diag Description | | Memo field. 32 alphanumeric |
| 10 | fDP | | Average value of the sum of squares of differential pressure fluctuation. |
| 11 | fDP Status | | Status of fDP |
| 12 | fSPI | | Average value of the sum of squares of low-pressure-side static pressure fluctuation. For gauge/absolute pressure transmitter, 0 is set. |
| 13 | fSPI Status | | Status of fSPI |
| 14 | fSPh | | Average value of the sum of squares of high-pressure-side static pressure fluctuation. For gauge/absolute pressure transmitter, 0 is set. |
| 15 | fSPh Status | | Status of fSPh |
| 16 | BlkF | | Blockage degree characterized in comparison of high- and low-pressure side pressure fluctuation value. |
| 17 | BlkF Status | | Status of BlkF |
| 18 | DPAvg | | Ratio of the average of differential pressure/pressure to the maximum span of an EJX transmitter. |
| 19 | DPAvg Status | | Status of DPAvg |
| 20 | Ratio fDP | | CRatio fDP or NRatio fDP is used by Diag Comp setting. fDP decreases and this parameter is used to determine whether one or both sides are plugged. |
| 21 | Ratio fDP Status | | Status of Ratio fDP |
| 22 | Ratio fSPI | | SQRT (fSPI/Ref fSPI). fSPI decreases and this parameter is used to determine whether low-pressure-side is plugged. |
| 23 | Ratio fSPI Status | | Status of Ratio fSPI |
| 24 | Ratio fSPh | | SQRT (fSPh/Ref fSPh). fSPh decreases and this parameter is used to determine whether high-pressure-side is plugged. |
| 25 | Ratio fSPh Status | | Status of Ratio fSPh |
| 26 | Ref fDP | | Value of fDP obtained under normal condition. |
| 27 | Ref fDP Status | | Status of fDP obtained under normal condition. |

| # | Parameter name | Default value | Explanation |
|----|-------------------|--------------------|--|
| 28 | Ref fSPI | | Value of fSPI obtained under normal condition. |
| 29 | Ref fSPI Status | | Status of fSPI obtained under normal condition. |
| 30 | Ref fSPh | | Value of fSPh obtained under normal condition. |
| 31 | Ref fSPh Status | | Status of fSPh obtained under normal condition. |
| 32 | Ref BlkF | | Value of BlkF obtained under normal condition. |
| 33 | Ref BlkF Status | | Status of BlkF obtained under normal condition. |
| 34 | Ref DPAvg | | Value of DPAvg obtained under normal condition. |
| 35 | Ref DPAvg Status | | Status of DPAvg obtained under normal condition. |
| 36 | Lim FDPmax | Refer to Table 4.3 | Upper limit for Ratio FDP to detect the blockage. Writable only when Diag Mode is "Stop". |
| 37 | Lim FDPmin | | Lower limit for Ratio FDP to detect the blockage. Writable only when Diag Mode is "Stop". |
| 38 | Lim fSPImax | | Upper limit for Ratio fSPI to detect the blockage. Writable only when Diag Mode is "Stop". |
| 39 | Lim fSPImin | | Lower limit for Ratio fSPI to detect the blockage. Writable only when Diag Mode is "Stop". |
| 40 | Lim fSPhmax | | Upper limit for Ratio fSPh to detect the blockage. Writable only when Diag Mode is "Stop". |
| 41 | Lim fSPhmin | | Lower limit for Ratio fSPh to detect the blockage. Writable only when Diag Mode is "Stop". |
| 42 | Lim BlkFmax | | Upper limit for BlkF to detect the blockage. Writable only when Diag Mode is "Stop". |
| 43 | Lim BlkFmin | | Lower limit for BlkF to detect the blockage. Writable only when Diag Mode is "Stop". |
| 44 | Lim DPAvgmax | | Upper limit for DPAvg . Writable only when Diag Mode is "Stop". |
| 45 | Lim DPAvgmin | | Lower limit for DPAvg . Writable only when Diag Mode is "Stop". |
| 46 | Ref Lim FDPmin | 7.0E-10 | Lower limit to judge whether Ref FDP is available for ILBD operation. Writable only when Diag Mode is "Stop". |
| 47 | Ref Lim fSPmin | 1.0E-10 | Lower limit to judge whether Ref fSPI and Ref fSPh are available for ILBD operation. Writable only when Diag Mode is "Stop". |
| 48 | Ref Lim BlkFmax | 0.5 | Upper limit to judge whether Ref BlkF is available for ILBD operation. Writable only when Diag Mode is "Stop". |
| 49 | Status group 9 | | Refer to Table 4.5. |
| 50 | Status group 10 | | Refer to Table 4.5. |
| 51 | CRatio FDP | | Ratio FDP is compensated by following formula and used as treatable monitoring value when the flow change is too large or small. $\text{Sqrt}(\text{fDP} / \text{Ref fDP}) \times \text{Ref DPAvg} / \text{DPAvg} $ When compensation is selected in Diag DP Comp , CRatio FDP is used as monitoring value. |
| 52 | CRatio FDP Status | | Status of CRatio FDP |
| 53 | NRatio FDP | | When Non-compensation is selected in Diag DP Comp , NRatio FDP is used as monitoring value. $\text{NRatio FDP} = \text{Sqrt}(\text{fDP} / \text{Ref fDP})$ |
| 54 | NRatio FDP Status | | Status of NRatio FDP |
| 55 | Diag DPComp | 0: Compensation | Whether fDP is referred by CRatio FDP or NRatio FDP is selected. |
| 56 | Diag Applicable | | After the reference value is obtained, the applicable blockage detection is displayed on this parameter. |

4.2.3 Heat Trace Monitoring

The EJX multivariable transmitter with Heat trace monitoring function calculates the flange temperature by using the two temperature sensors built in the EJX multivariable transmitter.

An analog alert is generated if the temperature reached to the preset level.

The flange temperature is based on the following parameters and calculation formula.

[Parameters]

| Parameter name | Explanation |
|-----------------------|---|
| Cap temp (CT) | Measured capsule temperature value |
| Amp temp (AT) | Measured amplifier temperature value |
| Flg temp (FT) | Flange temperature value (Calculated value) |
| Flg temp Coef (Cf) | Coefficient to calculate flange temperature |
| Flg temp Hi Alert Val | Threshold to generate FT high alarm |
| Flg temp Lo Alert Val | Threshold to generate FT low alarm |

[Calculation formula]

$$Flg\ temp\ (FT) = CT + Cf \times (CT-AT)$$

If the flange temperature exceeds the value preset to **Flg temp Hi Alert Val** or **Flg temp Lo Alert Val**, an alert is generated.



NOTE

The flange temperature is calculated by the calculation formula assumed that the capsule part of EJX multivariable transmitter is heated up or kept warm by an electrical heater or steam. In the case of an atmosphere temperature or less, the difference of temperature of approximately 3 to 4 °C, may occur because the amplifier temperature becomes higher than the capsule temperature.

4.2.3.1 Flg Temp Coef Setting

The value calculated according to the following procedure is set to **Flg temp Coef**.

- To enhance the calculation accuracy of the flange temperature, measure the actual flange temperature by using the temperature sensor etc.
- Calculate the ratio of the capsule temperature to the capsule temperature minus the amplifier temperature from the two temperature values measured by EJX multivariable transmitter.
- Derive the **Flg temp Coef** from the measured flange temperature and the ratio of the capsule temperature to the amplifier temperature in accordance with the following calculation formula.

Flg temp Coef (Cf) =

$$\frac{(Actual\ measured\ value\ of\ Flange\ temperature) - CT}{CT - AT}$$

In case of EJX910 V2.1 (HART 5 DTM), Flg Temp Coef parameter can be set by using Tuning function.

By setting the measured value of flange temperature, Flg Temp Coef is calculated by using capsule temperature and amplifier temperature.

- Procedure to call up the **Tuning** display.

| |
|--|
| Diag and Service → Advanced Diag Configurations → Heat Trace → Tuning |
|--|

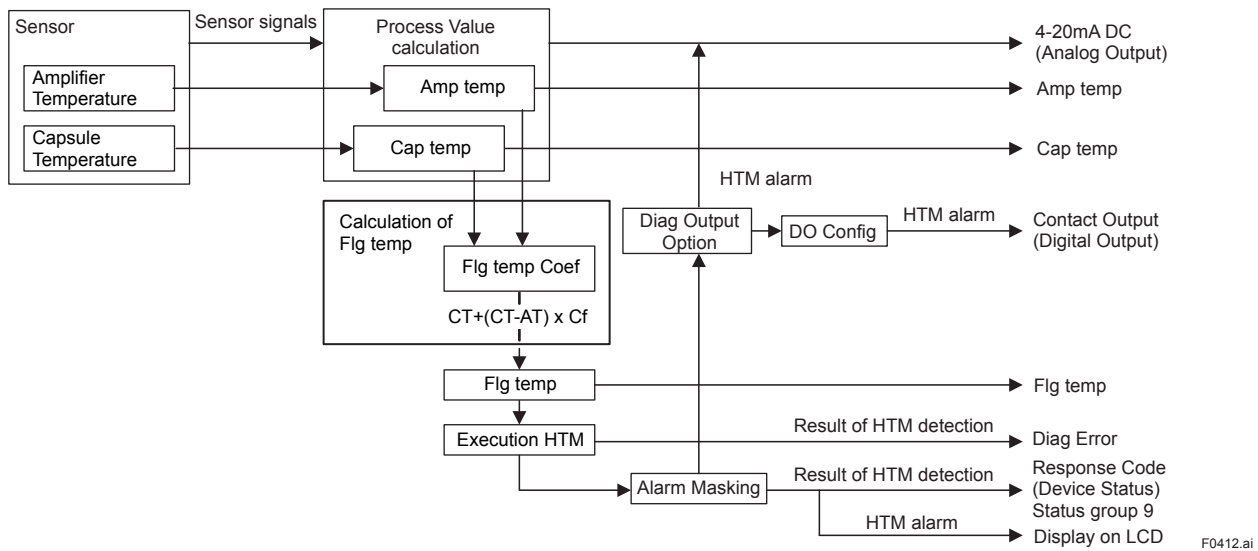
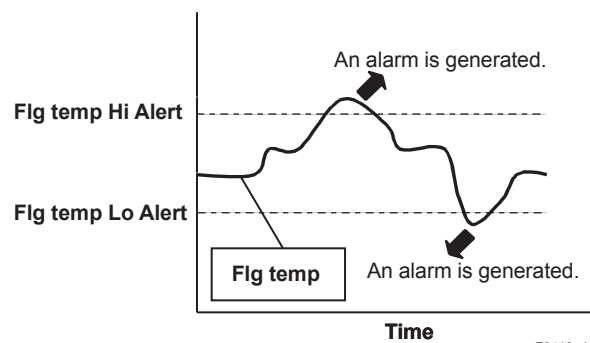

Figure 4.9 Functional Block Diagram of Heat Trace Monitoring (HTM)

4.2.3.2 Out of Temperature Measurement Range

When the flange temperature is out of measurement range, the alarm or alert is generated. For the detail of alarm and alert setting, refer to subsection 4.2.2.5.

The measurement range is set to **Flg temp Hi Alert Val** and **Flg temp Lo Alert Val**, which values can be specified within -50 to 130 deg C.



4.2.3.3 Parameter Lists for Heat Trace Monitoring

| # | Parameter name | Default value | Explanation |
|----|-----------------------|-------------------|---|
| 1 | Diag Error | 0x0000 | The results detected by ILBD or Heat trace monitoring are stored into this parameter. Also the condition abnormality in the diagnostic process is stored as an error. |
| 2 | Diag Option | 0x08FC | The masking in this parameter enable to display each error message and the status to the output signal or LCD. The error assigned to each bit is corresponding to that of Diag Error. Writable only when Diag Mode is "Stop". |
| 3 | Diag Out Option | Off | The error status can be output by 4-20 mA analog signal. There are following three output modes; Off, Burnout, or Fall back. |
| 4 | Diag Fixed Out Val | 21.6mA | Parameter for "Fall back" function in the Diag Out option. The output value in 4-20 mA analog signal is specified when an alarm is generated. The value must be entered within 3.8 to 21.6 mA. |
| 5 | Cap temp | | Measured capsule temperature value |
| 6 | Amp temp | | Measured Amplifier temperature value |
| 7 | Flg temp | (Note) | Calculated flange temperature value |
| 8 | Flg temp Coef | 0 | Coefficient to calculate flange temperature (Cf: Rt_1/Rt_2) Rt_1 : Thermal resistance between the flange and capsule. Rt_2 : Thermal resistance between the capsule and amplifier. |
| 9 | Flg temp Hi Alarm Val | 120 deg C | Upper limit of Flg temp |
| 10 | Flg temp Lo Alarm Val | -40 deg C | Lower limit of Flg temp |
| 11 | DO Select | Off | See subsection 3.3.12 Status Output |
| 12 | DO Signal type | ON WHEN AL DETECT | See subsection 3.3.12 Status Output |
| 13 | Digital Output | Off | See subsection 3.3.12 Status Output |

Note: The **Flg temp Coef** is 0 at the shipment so that the **Flg temp** outputs the same value as that of **Cap temp**.

4.3 Alarms and Countermeasures

Table 4.5 Alarm Message Summary

| Integral indicator | HART configuration tool display | Cause | 4-20mA Output operation during error | Countermeasure | Status group | Diagnostic List group *1 |
|--------------------|--|--|---|---|--------------|--------------------------|
| AL. 01 CAP.ERR | P sensor error Pressure Sensor Error *1 | Sensor problem. | Outputs the signal (High or Low) set with burnout direction switch. [status output: undefined] (About the output signal, refer to subsection 3.3.9) | Replace capsule if the error recurs after the transmitter is restarted. | 1 | Hardware Failure |
| | CT sensor error Capsule Temperature Sensor Error *1 | Capsule temperature sensor problem. | | Replace capsule. | | |
| | Cap EEPROM error Capsule EEPROM Error *1 | Capsule EEPROM problem. | | | | |
| AL. 02 AMP.ERR | AT sensor error Amp Temp Sensor Error *1 | Amplifier temperature sensor problem. | | Replace amplifier. | 2 | |
| | Amp EEPROM error Amp EEPROM Error *1 | Amplifier EEPROM problem. | | | | |
| | CPU board error CPU Board Error *1 | Amplifier problem. | | 4 | | |
| | AD Converter Error A/D Converter Error *1 | A/D Converter problem. | | | | |
| AL. 03 ET.ERR | ET sensor error External Temp Sensor Error *1 | External temperature sensor disconnection. | Check external temperature sensor. | 4 | | |
| — | No device ID No Device ID *1 | No device ID is found. | Continues to operate and output. | Replace amplifier. | 2 | |
| AL. 10 PRESS | P outside limit Pressure Outside Limit *1 | Differential pressure is outside measurement range limit of capsule. | When PV is Pres Output AO upper limit or AO Lower limit. (Refer to subsection 3.3.1) | Check input or replace capsule when necessary. | 3 | Transducer Status |
| AL. 11 ST. PRSS | SP outside limit Static Pressure Outside Limit *1 | Static pressure exceeds limit. | When PV is SP Output AO upper limit or AO Lower limit. (Refer to subsection 3.3.1) | | | |
| AL. 12 CAP.TMP | CT outside limit Cap Temp Outside Limit *1 | Capsule temperature is outside range (–50 to 130°C). | Continues to operate and output. | Use heat insulation or make lagging to keep temperature within range. | | |
| AL. 13 AMP.TMP | AT outside limit Amp Temp Outside Limit *1 | Amplifier temperature is outside range (–50 to 95°C). | | | | |
| AL. 14 EXT. TMP | ET outside limit External Temp Outside limit *1 | External temperature is outside range (–210 to 860°C). *3 | When PV is ET Output AO upper limit or AO Lower limit. (Refer to subsection 3.3.1) | Check input. | | |
| AL. 15 EXT. TMP | OHM outside limit OHM Outside limit *1 | External temperature sensor resistance is out specification (0 to 409.5Ω). | | | | |
| AL. 16 PLS | PLS outside limit PLS RNG Outside Limit *1 | Pulse output is out specification (10kHz). | Continues to operate and output. | Check settings and change them. | | |

*1: In case of EJX910 V2.1 (HART 5 DTM)

*2: Available only for HART 7

*3: When the saturated steam mode (ET Fixed = Saturated Steam) is set, calculated external temperature exceeds the device specification limit, 90 to 374°C. A static pressure limit corresponding to the limit is 70 kPa to 22.064 MPa.

*4: Previous HART 5 DD/DTM

| Integral indicator | HART configuration tool display | Cause | 4-20mA Output operation during error | Countermeasure | Status group | Diagnostic List group *1 |
|--------------------|--|---|--|---|--------------|--------------------------|
| AL. 30 PRS.RNG | P over range Pressure Over Range *1 | Differential pressure exceeds specified range. | When PV is Pres. Output AO upper limit or lower limit. (Refer to subsection 3.3.1) | Check input and range setting, and change them as needed. | 4 | Transducer Status |
| AL. 31 SP. RNG | SP over range Static Pressure Over Range *1 | Static pressure exceeds specified range. | When PV is SP Output AO upper limit or lower limit. (Refer to subsection 3.3.1) | | | |
| AL. 32 F. RNG | F over range Flow Over Range *1 | Flow exceeds specified range. | When PV is Flow Output AO upper limit or lower limit. (Refer to subsection 3.3.1) | | | |
| AL. 33 ET. RNG | ET over range External Temp Over Range *1 | External temperature exceeds specified range. | When PV is ET Output AO upper limit or lower limit. (Refer to subsection 3.3.1) | | | |
| AL. 35 P.HI | P high alarm Pressure High Alarm *1 | Input pressure exceeds specified threshold. | Continues to operate and output. | Check input. | 5 | |
| AL. 36 P.LO | P low alarm Pressure Low Alarm *1 | | | | | |
| AL. 37 SP.HI | SP high alarm Static Pressure High Alarm *1 | Input static pressure exceeds specified threshold. | | | | |
| AL. 38 SP.LO | SP low alarm Static Pressure Low Alarm *1 | | | | | |
| AL. 41 F.HI | F high alarm Flow High Alarm *1 | | | | | |
| AL. 42 F.LO | F low alarm Flow Low Alarm *1 | Input flow exceeds specified threshold. | | | 8 | |
| AL. 43 ET.HI | ET high alarm External Temp High Alarm *1 | | | | | |
| AL. 44 ET.LO | ET low alarm External Temp Low Alarm *1 | Input external temperature exceeds specified threshold. | | | | |
| AL. 50 P. LRV | Illegal P LRV Illegal Pressure LRV *1 | | | | | |
| AL. 51 P. URV | Illegal P URV Illegal Pressure URV *1 | Specified value is outside of setting range. | Holds at the output value that existed immediately before the error occurred. | Check settings and change them as needed. | 6 | |
| AL. 52 P. SPN | Illegal P SPAN Illegal Pressure SPAN *1 | | | | | |
| AL. 53 P. ADJ | P SPAN trim err Pressure SPAN Trim Error *1 P ZERO trim err Pressure ZERO Trim Error *1 | | | | | |
| AL. 54 SP. RNG | Illegal SP LRV Illegal Static Pressure LRV *1 | Specified value is outside of setting range. | Holds at the output value that existed immediately before the error occurred. | Check settings and change them as needed. | | |
| | Illegal SP URV Illegal Static Pressure URV *1 | | | | | |
| | Illegal SP SPAN Illegal Static Pressure SPAN *1 | | | | | |

*1: In case of EJX910 V2.1 (HART 5 DTM)

*2: Available only for HART 7

*3: When the saturated steam mode (ET Fixed = Saturated Steam) is set, calculated external temperature exceeds the device specification limit, 90 to 374°C. A static pressure limit corresponding to the limit is 70 kPa to 22.064 MPa.

*4: Previous HART 5 DD/DTM

| Integral indicator | HART configuration tool display | Cause | 4-20mA Output operation during error | Countermeasure | Status group | Diagnostic List group *1 | |
|--------------------|--|---|--|---|---|--------------------------|---|
| AL. 55 SP. ADJ | SP SPAN trim err Static Pressure SPAN Trim Error *1 | Specified value is outside of setting range. | Continues to operate and output. | Adjust settings and change them as needed. | 7 | Configuration | |
| | SP ZERO trim err Static Pressure ZERO Trim Error *1 | | | | | | |
| AL. 56 ET. RNG | Illegal ET SPAN Illegal External Temp SPAN *1 | | Holds at the output value that existed immediately before the error occurred. | Check settings and change them as needed. | 8 | | |
| AL. 57 ET. ADJ | ET SPAN trim err External Temp SPAN Trim Error *1 | | Continues to operate and output. | Adjust settings and change them as needed. | 7 | | |
| | ET ZERO trim err External Temp ZERO Trim Error *1 | | | | | | |
| AL. 58 FL. ADJ | F set outside Range Flow set Outside Range *1 | | Specified value is outside of setting range. | Holds at the output value that existed immediately before the error occurred. | Check settings and change them as needed. | | 8 |
| AL. 59 PLS.ADJ | PLS set err *1 | | Specified value is outside of setting pulse output. | Normal calculation. | | | 7 |
| — | ET Fixed Mode *1 | Under Temperature Fix Mode. PV is ET | Temp. Output Fix at 4mA. | Leave from Temperature Fix Mode. | 7 | | |
| AL. 79 OV. DISP | — | Displayed value exceeds limit. | Continues to operate and output. | Check settings and change them as needed. | — | Diag Status | |
| AL.87 FLG. HI | FT high alarm Flg Temp High Alarm *1 | Flange temperature exceeds a preset upper limit. | It depends on the Diag Out Option setting. | Check the heater failure. | 9 | | |
| AL.87 FLG. LO | FT low alarm Flg Temp Low Alarm *1 | Flange temperature is below a preset lower limit. | Off: Continue to operate and output. Burnout: Outputs AO upper limit or AO lower limit. Fall back: Outputs Diag Out Fixed Val. | Check the capsule temp. and Amplifier temp. Adjust Flg Temp Coef. | | | |
| AL.88 INVR.DP | Invalid Ref DP Invalid Ref fDP *1 | Differential pressure/ pressure fluctuation does not reach the reference level required to blockage detection so that no blockage detection is carried out. | Continue to operate and output. | Check process condition. | | | |
| AL.88 INVR.SL | Invalid Ref SPL Invalid Ref fSPI *1 | Low-pressure-side fluctuation does not reach the reference fluctuation level required to blockage detection. | | | | | |
| AL.88 INVR.SH | Invalid Ref SPH Invalid Ref fSPH *1 | High-pressure-side fluctuation does not reach the reference fluctuation level required to blockage detection. | | | | | |
| AL.88 INVR.F | Invalid Ref F Invalid Ref BlkF *1 | BlkF can not be used for blockage detection for some reasons. | | | | | |
| AL.89 ILBD.OV | ILBD over range Outside Diagnosis Range *1 | Appointed the diagnosis range outside. | | | | | |

*1: In case of EJX910 V2.1 (HART 5 DTM)

*2: Available only for HART 7

*3: When the saturated steam mode (ET Fixed = Saturated Steam) is set, calculated external temperature exceeds the device specification limit, 90 to 374°C. A static pressure limit corresponding to the limit is 70 kPa to 22.064 MPa.

*4: Previous HART 5 DD/DTM

| Integral indicator | HART configuration tool display | Cause | 4-20mA Output operation during error | Countermeasure | Status group | Diagnostic List group *1 |
|-----------------------|--|--|--|--------------------------|--------------|--------------------------|
| AL.89 B BLK | B Blocking | B Blocking (both-side blockage) is detected. | It depends on the Diag Out Option setting. | Check process condition. | 10 | Diag Status |
| AL.89 H BLK | H Side Blocking High Side Blocking *1 | High-pressure-side blockage is detected. | Off: Continue to operate and output. | | | |
| AL.89 L BLK | L Side Blocking Low Side Blocking *1 | Low-pressure-side blockage is detected. | Burnout: Outputs AO upper limit or AO lower limit. | | | |
| AL.89 H LRG | Large Fluct H Large Fluctuation of High Side *1 | Pressure fluctuation amplitude of high-pressure side is large. | Fall back: Outputs Diag Out Fixed Val. | | | |
| AL.89 L LRG | Large Fluct L Large Fluctuation of Low Side *1 | Pressure fluctuation amplitude of low-pressure side is large. | | | | |
| AL.89 A BLK | A Blocking | A Blocking (single-side blockage) is detected. | | | | |
| AL. 90 SIM | Flow Simulation mode *2 Simulation mode *4 | Under Simulation Mode for flow. | Simulate input output. | Check Simulation Mode. | 5 | Transducer Status |
| AL. 91 *2 F. SIM | F Simulate Mode | Under Simulation Mode for device variables. | Output the setting value of Simulate-Value | Check Simulation Mode | 11 | — |
| AL. 91 *2 P. SIM | P Simulate Mode | | | | | |
| AL.91 *2 SP. SIM | SP Simulate Mode | | | | | |
| AL. 91 *2 ET. SIM | ET Simulate Mode | | | | | |
| AL. 91 *2 TF. SIM | TF Simulate Mode | | | | | |
| AL. 91 *2 PCT. SIM | % Simulate Mode | | | | | |
| AL. 91 *2 AO. SIM | AO Simulate Mode | | | | | |

*1: In case of EJX910 V2.1 (HART 5 DTM)

*2: Available only for HART 7

*3: When the saturated steam mode (ET Fixed = Saturated Steam) is set, calculated external temperature exceeds the device specification limit, 90 to 374°C. A static pressure limit corresponding to the limit is 70 kPa to 22.064 MPa.

*4: Previous HART 5 DD/DTM

Table 4.6 HART Configuration Tool Error Messages

| Error message | Probable cause | Countermeasure |
|---|--|---|
| Invalid selection | — | Change the setting. |
| Passed Parameter Too Large | Set value is too high. | |
| Passed Parameter Too Small | Set value is too low. | |
| Too Few Data Bytes Received | — | — |
| In Write Protect Mode | Operation is set in the Write Protect mode. | — |
| Lower Range Value too High | LRV set point is too high. | Change the range. |
| Lower Range Value too Low | LRV set point is too low. | |
| Upper Range Value too High | URV set point is too high. | |
| Upper Range Value too Low | URV set point is too low. | |
| Span too Small | Set span is too small. | |
| Applied Process too High | Applied pressure is too high. | Adjust the applied pressure. |
| Applied Process too Low | Applied pressure is too low. | |
| New Lower Range Value Pushed Upper Range Value Over Sensor Limit | The shift of URV according to the new LRV setting exceeds USL. | Change the URV setting within the range of USL. |
| Excess Correction Attempted | Amount of correction is too much. | Adjust the amount. |
| Small Char. did not convert successfully | Characters are not convertible. e.g. % | Correct the setting. |
| Not in fixed current mode | The fixed current mode is desired but not set in that mode. | Set in the fixed current mode. |
| In Multidrop Mode | Operation is set in the multi-drop mode. | — |
| Not write Protect | Operation is set without a password. | — |

Table 4.7 Device Status

| Item | Description |
|-----------------------------------|---|
| Field Device Malfunction (0x80) | Field device has malfunctioned due to a hardware error or failure. |
| Configuration Changed (0x40)* | A modification has been made to the configuration of the field device. |
| Cold Start (0x20) | A reset of the field device has occurred, or power has been removed and reapplied. |
| More Status Available (0x10) | Field device has more status available. |
| PV Analog Output Fixed (0x08) | Analog output 1 and its digital representation are in fixed mode, and not responsive to input changes. |
| PV Analog Output saturated (0x04) | Analog output 1 and its digital representation are outside the operating range limits, and not responding to input. |
| Non-PV out of Limits (0x02) | Process applied to the non-primary variable is outside the operating limits of the field device. |
| PV out of Limits (0x01) | Process applied to the primary variable is outside the operating limits of the field device. |

*: This flag can be reset. Refer to subsection 4.1.3 (6) Reset Configuration Changed Flag

Table 4.8 Extended Device Status and Status 0

| Ext dev status / Extended Device Status | Description |
|--|--|
| Maintenance Required (0x01) | Field device requires maintenance. |
| Device Variable Alert (0x02) | Any device variable is in an alarm or warning state. |
| Critical Power Failure (0x04) | Power failure. |

| Device Diagnostic Status 0 / Standardized Status 0 | Description |
|---|---|
| Device Variable Simulation Active (0x01) | The device is in simulation mode and one or more of its device variables are not representative of the process. |
| Non-Volatile Memory Defect (0x02) | The Non-Volatile memory check is invalid or maybe corrupt. |
| Volatile Memory Defect (0x04) | Not used |
| Watchdog Reset Executed (0x08) | Not used |
| Power Supply Conditions Out of Range (0x10) | Not used |
| Environmental Conditions Out of Range (0x20) | An internal or environmental condition is beyond acceptable limits. |
| Electronic Defect (0x40) | A hardware problem not related to the sensor has been detected. |
| Device Configuration Locked (0x80) | Device is in write-protect or is locked. |

Table 4.9 Data Quality and Limit Status

| Data Quality | Description |
|---------------------|--|
| Good | The value may be used in control. |
| Poor Accuracy | The quality of the value is less than normal, but the value may still be useful. |
| Manual / Fixed | The value is manually fixed. |
| Bad | The value is not useful. |

| Limit Status | Description |
|---------------------|---|
| Constant | The value cannot be changed, no matter what the process does. |
| Low Limited | The value is out of the high or low limit. |
| High Limited | |
| Not Limited | The value is free to change. |

Table 4.10 Relationship between Alarm and Status available for HART 7

| Integral Indicator | HART configuration tool display | Device Status | Extended Device Status | Value and Status (Data Quality and Limit Status) | | | | | | |
|--------------------|---------------------------------|--|------------------------------|--|--|--|--|--------------------------------|---|--------------|
| | | | | Flow | Differential Pressure (DP) | Static Pressure (SP) | External Temperature*3 (ET) | Total Flow | % range | Loop current |
| AL.01 CAP.ERR | P sensor error | Device Malfunction (0x80) | Maintenance Required (0x01) | Value: Hold value Status: Bad and Constant | | | | | Value: Hold value Status: Bad and Low Limited/High Limited*1 | |
| | CT sensor error | | | Value: Hold value Status: Bad and Constant | | | | | | |
| | Cap EEPROM error | | | Value: Hold value Status: Bad and Constant | | | | | | |
| AL.02 AMP.ERR | AT sensor error | | | Value: Hold value Status: Bad and Constant | | | | | Value: Hold value Status: Bad and Low Limited/High Limited*1 | |
| | Amp EEPROM error | | | Value: Hold value Status: Bad and Constant | | | | | | |
| | CPU board error | | | Value: Hold value Status: Bad and Constant | | | | | | |
| | AD Converter error | | | Value: Hold value Status: Bad and Constant | | | | | | |
| AL.03 ET. ERR | ET sensor error | | | Value: Hold value Status: Bad and Constant | | | | | Value: Hold value Status: Bad and Low Limited/High Limited*1 | |
| --- | No device ID | --- | --- | Value: Measured value Status: Good and Not Limited | | | | | | |
| AL.10 PRESS | P outside limit | In the case of PV: Primary Variable Out of Limits (0x01) | Device Variable Alert (0x02) | Value: Measured value Status: Poor Accuracy and Not Limited | Value: Measured value Status: Poor Accuracy and Not Limited | Value: Measured value Status: Good and Not Limited | Value: Measured value Status: Poor Accuracy and Not Limited | Same as Value and Status of PV | | |
| AL.11 ST.PRSS | SP outside limit | In the case except PV: Non-Primary Variable Out of Limits (0x02) | | | | | | | | |
| AL.12 CAP.TMP | CT outside limit | Non-Primary Variable | | | | | | | | |
| AL.13 AMP.TMP | AT outside limit | Out of Limits (0x02) | | Value: Measured value Status: Good and Not Limited | | | | | | |
| AL.14 EXT.TMP | ET outside limit | In the case of PV: Primary Variable Out of Limits (0x01) | | Value: Measured value Status: Poor Accuracy and Not Limited | Value: Measured value Status: Good and Not Limited | Value: Measured value Status: Poor Accuracy and Not Limited | Value: Measured value Status: Poor Accuracy and Not Limited | Same as Value and Status of PV | | |
| AL.15 EXT.TMP | OHM outside limit | In the case except PV: Non-Primary Variable Out of Limits (0x02) | | | | | | | | |
| AL.16 PLS | PLS outside limit | --- | | Value: Measured value Status: Good and Not Limited | | | | | | |

*1: Depend on the setting of hardware switch

*2: Depend on the direction of range over (high or low)

*3: Data Quality and Limit Status follow static pressure status when the saturated steam mode (ET Fixed = Saturated Steam) is set.

| Integral Indicator | HART configuration tool display | Device Status | Extended Device Status | Value and Status (Data Quality and Limit Status) | | | | | | |
|--------------------|---------------------------------|---|------------------------------|--|----------------------------|--|--|---|--|--|
| | | | | Flow | Differential Pressure (DP) | Static Pressure (SP) | External Temperature*3 (ET) | Total Flow | % range | Loop current |
| AL.30 PRS.RNG | P over range | In the case of PV: Loop Current Saturated (0x04) | Device Variable Alert (0x02) | Value: Measured value Status: Good and Not Limited | | | | | In the case of PV Value: Hold value Status: Bad and Low Limited/High Limited*2 In the case except PV Value: Measured value Status: Good and Not Limited | |
| AL.31 SP. RNG | SP over range | | | | | | | | | |
| AL.32 F. RNG | F over range | | | | | | | | | |
| AL.33 ET. RNG | ET over range | | | | | | | | | |
| AL.35 P. HI | P high alarm | --- | | Value: Measured value Status: Good and Not Limited | | | | | | |
| AL.36 P. LO | P low alarm | | | | | | | | | |
| AL.37 SP. HI | SP high alarm | | | | | | | | | |
| AL.38 SP. LO | SP low alarm | | | | | | | | | |
| AL.41 F. HI | F high alarm | | | | | | | | | |
| AL.42 F. LO | F low alarm | | | | | | | | | |
| AL.43 ET. HI | ET high alarm | | | | | | | | | |
| AL.44 ET. LO | ET low alarm | | | | | | | | | |
| AL.50 P. LRV | Illegal P LRV | | | Value: Measured value Status: Good and Not Limited | | | | | In the case PV is DP Value: Hold value Status: Bad and Constant | |
| AL.51 P. URV | Illegal P URV | | | | | | | | In the case except shown above Value: Measured value Status: Good and Not Limited | |
| AL.52 P. SPN | Illegal P SPAN | | | | | | | | | |
| AL.53 P. ADJ | P SPAN trim err | | | Value: Measured value Status: Poor Accuracy and Not Limited | | Value: Measured value Status: Poor Accuracy and Not Limited | | Value: Measured value Status: Good and Not Limited | | Value: Measured value Status: Poor Accuracy and Not Limited |
| | P ZERO trim err | | | | | | In the case PV is DP or Flow Value: Measured value Status: Poor Accuracy and Not Limited | | In the case except shown above Value: Measured value Status: Good and Not Limited | |
| AL.54 SP. RNG | Illegal SP LRV | Value: Measured value Status: Good and Not Limited | | | | | In the case PV is SP Value: Hold value Status: Bad and Constant | | | |
| | Illegal SP URV | | | | | | In the case except shown above Value: Measured value Status: Good and Not Limited | | | |
| | Illegal SP SPAN | | | | | | | | | |

*1: Depend on the setting of hardware switch

*2: Depend on the direction of range over (high or low)

*3: Data Quality and Limit Status follow static pressure status when the saturated steam mode (ET Fixed = Saturated Steam) is set.

| Integral Indicator | HART configuration tool display | Device Status | Extended Device Status | Value and Status (Data Quality and Limit Status) | | | | | | |
|--------------------|---------------------------------|---------------|------------------------------|---|---|--|--|---|--|--------------|
| | | | | Flow | Differential Pressure (DP) | Static Pressure (SP) | External Temperature*3 (ET) | Total Flow | % range | Loop current |
| AL.55 SP.ADJ | SP SPAN trim err | --- | Device Variable Alert (0x02) | Value: Measured value Status: Poor Accuracy and Not Limited | Value: Measured value Status: Good and Not Limited | Value: Measured value Status: Poor Accuracy and Not Limited | Value: Measured value Status: Good and Not Limited | Value: Measured value Status: Poor Accuracy and Not Limited | In the case PV is SP or Flow Value: Measured value Status: Poor Accuracy and Not Limited | |
| | SP ZERO trim err | | | In the case except shown above Value: Measured value Status: Good and Not Limited | | | | | | |
| AL.56 ET.RNG | Illegal ET SPAN | --- | --- | Value: Measured value Status: Good and Not Limited | | | | | In the case PV is ET Value: Hold value Status: Bad and Constant In the case except shown above Value: Measured value Status: Good and Not Limited | |
| AL.57 ET.ADJ | ET SPAN trim err | | | Value: Measured value Status: Poor Accuracy and Not Limited | Value: Measured value Status: Good and Not Limited | Value: Measured value Status: Poor Accuracy and Not Limited | Value: Measured value Status: Poor Accuracy and Not Limited | In the case PV is ET or Flow Value: Measured value Status: Poor Accuracy and Not Limited | | |
| AL.58 FL.ADJ | F set outside Range | --- | --- | Value: Measured value Status: Good and Not Limited | | | | | In the case PV is Flow Value: Hold value Status: Bad and Constant In the case except shown above Value: Measured value Status: Good and Not Limited | |
| | ET ZERO trim err | | | In the case except shown above Value: Measured value Status: Good and Not Limited | | | | | | |
| AL.59 PLS.ADJ | PLS set err | --- | --- | Value: Measured value Status: Good and Not Limited | | | | | | |
| --- | ET Fixed Mode | | | Value: Measured value Status: Good and Not Limited | | Value: Hold value Status: Good and Constant | Value: Measured value Status: Good and Not Limited | In the case PV is ET Value: Hold value Status: Good and Constant In the case except shown above Value: Measured value Status: Good and Not Limited | | |
| AL.79 OV.DISP | (None) | --- | --- | Value: Measured value Status: Good and Not Limited | | | | | | |

*1: Depend on the setting of hardware switch

*2: Depend on the direction of range over (high or low)

*3: Data Quality and Limit Status follow static pressure status when the saturated steam mode (ET Fixed = Saturated Steam) is set.

| Integral Indicator | HART configuration tool display | Device Status | Extended Device Status | Value and Status (Data Quality and Limit Status) | | | | | | |
|--------------------|---------------------------------|---|------------------------------|---|---|---|---|------------|---|--------------|
| | | | | Flow | Differential Pressure (DP) | Static Pressure (SP) | External Temperature*3 (ET) | Total Flow | % range | Loop current |
| AL.87 FLG. HI | FT high alarm | --- | Maintenance Required (0x01) | Value: Measured value Status: Good and Not Limited | | | | | In the case "Off" is set to Diag Out Option Value: Measured value Status: Good and Not Limited In the case "Burnout" is set to Diag Out Option Value: Low Limited/High Limited Status: Bad and Low Limited/High Limited*1 In the case "Fall back" is set to Diag Out Option Value: Fixed value Status: Bad and Constant | |
| AL.87 FLG. LO | FT low alarm | | | | | | | | | |
| AL.88 INVR.DP | Invalid Ref DP | Value: Measured value Status: Good and Not Limited | | | | | | | | |
| AL.88 INVR.SL | Invalid Ref SPL | | | | | | | | | |
| AL.88 INVR.SH | Invalid Ref SPH | | | | | | | | | |
| AL.88 INVR.F | Invalid Ref F | | | | | | | | | |
| AL.89 ILBD.OV | ILBD over range | Value: Measured value Status: Good and Not Limited | | | | | | | | |
| AL.89 B BLK | B Blocking | Value: Measured value Status: Good and Not Limited | | | | | In the case "Off" is set to Diag Out Option Value: Measured value Status: Good and Not Limited In the case "Burnout" is set to Diag Out Option Value: Low Limited/High Limited Status: Bad and Low Limited/High Limited*1 In the case "Fall back" is set to Diag Out Option Value: Fixed value Status: Bad and Constant | | | |
| AL.89 H BLK | H Side Blocking | | | | | | | | | |
| AL.89 L BLK | L Side Blocking | | | | | | | | | |
| AL.89 H LRG | Large Fluct H | | | | | | | | | |
| AL.89 L LRG | Large Fluct L | | | | | | | | | |
| AL.89 A BLK | A Blocking | | | | | | | | | |
| AL.90 SIM | Flow Simulation mode | --- | Device Variable Alert (0x02) | Value: Measured value Status: Good and Not Limited | Value: Measured value Status: Good and Not Limited or Value: Simulation value Status: Manual/Fixed and Constant | Value: Measured value Status: Good and Not Limited | Same as Value and Status of PV | | | |

*1: Depend on the setting of hardware switch

*2: Depend on the direction of range over (high or low)

*3: Data Quality and Limit Status follow static pressure status when the saturated steam mode (ET Fixed = Saturated Steam) is set.

| Integral Indicator | HART configuration tool display | Device Status | Extended Device Status | Value and Status (Data Quality and Limit Status) | | | | | | |
|--------------------|---------------------------------|--|------------------------------|---|---|---|---|--------------------------------|---------|--------------|
| | | | | Flow | Differential Pressure (DP) | Static Pressure (SP) | External Temperature* ³ (ET) | Total Flow | % range | Loop current |
| AL.91 F.SIM | F Simulate Mode | In the case of PV: Loop Current Fixed (0x08) | Device Variable Alert (0x02) | Value and Status: Flow simulation value | | | | Same as Value and Status of PV | | |
| AL.91 P.SIM | P Simulate Mode | | | Value and Status: Pressure simulation value | Value: Measured value Status: Good and Not Limited | | | | | |
| AL.91 SP.SIM | SP Simulate Mode | | | Value and Status: Static Pressure simulation value | | | | | | |
| AL.91 ET.SIM | ET Simulate Mode | | | Value: Measured value Status: Good and Not Limited | Value and Status: Temperature simulation value | | | | | |
| AL.91 TF.SIM | TF Simulate Mode | --- | | | | Value and Status: Total Flow simulation value | Value: Measured value Status: Good and Not Limited | | | |
| AL.91 PCT.SIM | % Simulate Mode | Loop Current Fixed (0x08) | Device Variable Alert (0x02) | Value: Measured value Status: Good and Not Limited | | | Value and Status: Simulation value (%) | | | |
| AL.91 AO.SIM | AO Simulate Mode | | | Value and Status: Simulation value (mA) | | | | | | |

*1: Depend on the setting of hardware switch

*2: Depend on the direction of range over (high or low)

*3: Data Quality and Limit Status follow static pressure status when the saturated steam mode (ET Fixed = Saturated Steam) is set.

5. Parameter Summary

| Function | Label | Item | Contents | Default value | Handling ^{*1} |
|---|--------------------------------------|---|---|---|------------------------|
| Analog output | AO alm typ | Analog output alarm type | High or Low | | R |
| | AO lower limit | Lower limit of analog output | 3.8000 to 21.6000 mA | 3.8000 mA | W |
| | AO upper limit | Upper limit of analog output | 3.8000 to 21.6000 mA | 21.6000 mA | W |
| | Auto recover | Auto-recover from hardware error | Off or On | On | W |
| Analog output trim | Clear D/A trim | Reset analog output trim | | | M |
| | D/A trim | Analog output trim with ammeter | | | M |
| | Scaled D/A trim | Analog output trim with voltmeter | | | M |
| | Channel flags | Analog channel flags | | 0x00 | R |
| Burst mode | Burst mode | Burst mode ^{*2} | Off or On HART 5 Off or Wired HART Enabled HART 7 | Off | W |
| | Burst option HART 5 | Burst option | Xmtr Variables, PV, % range/ current, Process vars/crnt | | W |
| | Burst Xmtr Vals HART 5 | Burst transmitter values | | | M |
| | Burst Command HART 7 | Burst Command ^{*2} | Cmd 1: PV Cmd 2: % range/current Cmd 3: Dyn vars/current Cmd 9: Device vars w/status Cmd33: Device Variables Cmd 48: Read Additional Device Status. | Cmd 1: PV | W |
| | Burst Variable Code HART 7 | Device Variable for the Burst Message ^{*2} | Max 8 slots. | Flow | W |
| | Set Burst Trigger HART 7 | Configure burst trigger | Configure Burst Msg Trigger Mode and Burst Trigger Level | | M |
| | Set Burst Period HART 7 | Configure burst period | Configure Update Period and Max Update Period | | M |
| | Burst Msg Trigger Mode HART 7 | Burst Trigger Mode Selection Code ^{*2} | (Continuous, Window, Rising, Falling, On-change) | Continuous | R |
| | Burst Trigger Level HART 7 | Burst Trigger Level ^{*2} | | NaN (Not a Number) | R |
| | Burst Trigger Unit HART 7 | Burst Trigger Unit ^{*2} | | Not used | R |
| | Update Period HART 7 | Update Period for Burst mode ^{*2} | Update period for burst message | Burst Message 1: 0.5sec 2: 60sec 3: 60sec | R |
| | Max Update Period HART 7 | Max Update Period for Burst mode ^{*2} | Maximum update period for burst message | 60 min | R |
| | Event Notification | Control / Mode HART 7 | Event Notification | (Enable event notification on token-passing data link layer, Off) | Off |
| Device Status Mask HART 7 | | Event Masking | | | W |
| Status group 1 to 11 Mask HART 7 | | | | | |
| Ext dev status Mask / Extended Device Status Mask HART 7 | | | | | |
| Diagnostic Status 0 Mask / Standardized Status 0 Mask HART 7 | | | | | |
| Set Event Notification Timing HART 7 | | Configure Event Notification Timing | Configure Event Notification Retry Time, Event Max Update Time and Event Debounce Interval | | M |
| Retry Time / Retry Rate HART 7 | | Event Notification Retry Time | | | R |

*1: Handling: R-Read only, W-Read & Write, M-Method, G-Applicable for option code DG6

*2: Max three Burst Messages (Burst Message 1, Burst Message 2, Burst Message 3)

*3: Available only when the device revision is 12 or later

| Function | Label | Item | Contents | Default value | Handling*1 |
|---|--|---|---|---------------|------------|
| (Event Notification) | Max Update Time / Max Update Rate HART 7 | Max Update Time for Event Notification | | | R |
| | Debounce Interval HART 7 | Event Debounce Interval | Debounce Interval to detect an event. | | R |
| | Acknowledge Event Notification HART 7 | Acknowledge Event Notification | | | W |
| | Status HART 7 | Event Status | 0x00 Approved event or no event 0x10 Configuration changed event pending 0x20 Device status event pending 0x40 More status available event pending | | R |
| | Event Number HART 7 | Event Number | | | W |
| | Time First Unack Event Triggered HART 7 | Time First Unack Event Triggered | | | W |
| | Latched Cfg chng count HART 7 | Latched Cfg chng count | | | W |
| | Latched Device Status HART 7 | Device status when event occurred | | | W |
| | Latched Status group 1 to 11 HART 7 | Field device status when event occurred | | | W |
| | Latched Ext dev status HART 7 | | | | |
| Latched Device Diagnostic Status 0 HART 7 | | | | | |
| Date | Date | Date | **/**/** | | W |
| Descriptor | Descriptor | Descriptor | 16 alphanumerics | As specified | W |
| Device information | Country HART 7 | Country code | US, JP, DE, FR, ES, RU, CN | JP | W |
| | Dev id | Device ID | | | R |
| | Distributor | Yokogawa | | YOKOGAWA | R |
| | Drain vent matl | Drain and vent plug material | | | W |
| | Extra No. | Customizaion number | | | R |
| | Ext SW | External zeroing permission | Disabled or Enabled | Disabled | W |
| | Fill fluid | Fill fluid | | | W |
| | Final asbly num | Final assembly number | | | W |
| | Fld dev rev | Field device revision | | | R |
| | Gasket matl | Gasket material | | | W |
| | Isoltr matl | Capsule material | | | W |
| | Mftr Date | Manufactured date | | | R |
| | Model 1/MS Code 1 | Memo field for MS code 1 | 32 alphanumerics | | W |
| | Model 2/MS Code 2 | Memo field for MS code 2 | 32 alphanumerics | | W |
| | Model 3/MS Code 3 | Memo field for MS code 3 | 32 alphanumerics | | W |
| | Meas Func *3 HART 7 | Measurement function | A: Multi Sensing B: Mass Flow Measurement | As specified | R |
| | Num of RS | Number of remote seal | | | W |
| | Process Conn matl | Process connection material | | | W |
| | Process Conn size | Process connection size | | | W |
| | Process Conn type | Process connection type | | | W |
| | PT100 Serial No. | Serial number of PT100 | | | W |
| | RS fill fluid | Fill fluid of remote seal | | | W |
| | RS Isoltr matl | Remote seal material | | | W |
| RS type | Remote seal type | | | W | |
| Serial No. | Serial number | | | R | |

*1: Handling: R-Read only, W-Read & Write, M-Method, G-Applicable for option code DG6
 *2: Max three Burst Messages (Burst Message 1, Burst Message 2, Burst Message 3)
 *3: Available only when the device revision is 12 or later

| Function | Label | Item | Contents | Default value | Handling*1 |
|----------------------|--|--|---|---------------------------|------------|
| (Device information) | Software rev | Software revision | | | R |
| | Style No. | Style number | Style number of product | | R |
| | Universal rev | Universal revision | 16 alphanumerics | | R |
| | Cfg chng count <small>HART 7</small> | Configuration change counter | | 0 | R |
| | Reset Cfg chng flag <small>HART 7</small> | Reset Configuration change flag | | | M |
| | Device Profile <small>HART 7</small> | Device Profile | | Process automation device | R |
| | Max dev vars <small>HART 7</small> | Max device variables | | 4 | R |
| | Model | Model | Model name + Measurement span in the Suffix Codes Ex) "EJX910 M" | | R |
| Display setup | Bar Indicator | Bar indicator | Off or On | On | W |
| | Disp Out 1/Disp1 | LCD output 1 | PV %, Flow, Pres, SP, EXT. TEMP, ENGR.PV, or TOTAL FLOW | PV % | W |
| | Disp Out 2/Disp2 | LCD output 2 | PV %, Flow, Pres, SP, EXT. TEMP, ENGR.PV, TOTAL FLOW, or Not used | Not used | W |
| | Disp Out 3/Disp3 | LCD output 3 | (Ditto) | Not used | W |
| | Disp Out 4/Disp4 | LCD output 4 | (Ditto) | Not used | W |
| | Disp % Reso | % display resolution | Normal or High resolution | Normal | W |
| | Engr exp | User set exponent | ---, x10, x100, x1000 | --- or as specified | W |
| | Engr LRV | User set lower range value | Unit specified in Set Engr Unit | As specified | W |
| | Engr point | Decimal place for user set | 0 to 4 | 2 | W |
| | Engr URV | User set upper range value | Unit specified in Set Engr Unit | As specified | W |
| | Engr Unit | | | | R,W*3 |
| | ET disp point | Decimal place for external temperature | 0 to 4 | 2 | W |
| | Flow disp point | Decimal place for flow | 0 to 4 | 2 | W |
| | Modify Engr Unit | User set engineering unit | | As specified | M |
| | Pres disp point | Decimal place for differential pressure | 0 to 4 | 2 | W |
| | Set Engr Unit | Engineering unit select | | As specified | M |
| | SP disp point | Decimal place for static pressure | 0 to 4 | 2 | W |
| | TF disp point | Decimal place for total flow | 0 to 4 | 2 | W |
| | Squawk <small>HART 7</small> | Squawk | Specify the device under the communication (turn the LCD on). | | M |
| DP setup | Pres Damp | Damping time constant for DP | 0.00 to 100.00 sec | 2.00 or as specified | W |
| | Pres Min Span | Minimum span for differential pressure | | | R |
| | Pres LRV | Lower range value for differential pressure | | As specified | W |
| | Pres LSL | Lower sensor limit for differential pressure | | | R |
| | Pres URV | Upper range value for differential pressure | | As specified | W |
| | Pres USL | Upper sensor limit for differential pressure | 0 to 4 | | R |
| Error log | Error log Clear | Clear error records | | | M |
| | Error log view | Error records | Log1 (latest) to log4 | | M |

*1: Handling: R-Read only, W-Read & Write, M-Method, G-Applicable for option code DG6

*2: Max three Burst Messages (Burst Message 1, Burst Message 2, Burst Message 3)

*3: Available only when the device revision is 12 or later

| Function | Label | Item | Contents | Default value | Handling*1 |
|-------------------------------|------------------------------------|---|---|----------------------|------------|
| ET setup | ET Damp | Damping time constant for ET | 0.00 to 100.00 sec | 1.00 or as specified | W |
| | ET Fixed | External temperature fix mode | No, Yes, FALL BACK, Saturated Steam *3 | No | W |
| | ET Min Span | Minimum span for external temperature | | | R |
| | ET LRV | Lower range value for ET | | | W |
| | ET LSL | Lower sensor limit for ET | | -200°C | R |
| | ET URV | Upper range value for ET | | | W |
| | ET USL | Upper sensor limit for ET | | 850°C | R |
| | Fixed ET Val | Temperature value at ET fix mode | 20°C (deg C) | 20°C | W |
| Flow setup | Flow Damp | Damping time constant for flow | 0.00 to 100.00 sec | 1.00 or as specified | W |
| | Flow LRV | Lower range value for flow | | | W |
| | Flow URV | Upper range value for flow | | | W |
| Loop test | Loop test | Test output setting | Within AO lower and upper limits | | M |
| | Test Auto Release Time | “Flow simulation”, “DO Test” and “Test output” duration time selection. | 10min, 30min, 60min, 3h, 6h, 12h | 10min | W |
| Low cut | Low cut | Low cut | 0.00 to 20.00% | 10% | W |
| | Low cut mode | Low cut mode | Off or On | Off | W |
| Master test | Master test | Software reset and self test | | | M |
| Message | Message | Message | 32 alphanumerics | As specified | W |
| Number of requested preambles | Num req preams | Number of requested preambles | | | R |
| | Num resp preams HART 7 | Number of response preambles | | 5 | W |
| Piping orientation | H/L Swap | Impulse piping accessing direction | Normal or Reverse | Normal | W |
| Poll address | Poll addr | Poll address for multidrop use | 0 to 15 (HART 5), 0 to 63 (HART 7) | 0 | W |
| | Loop current mode HART 7 | Loop current mode in Multi Drop mode | (Disabled, Enabled) | Enable | W |
| Process Alerts | Digital Output | Display of contact output | Off or On | Off | R |
| | DO Frequency | Frequency of Digital Output | | | R |
| | DO Select | Contact output select | Combination of Pres, SP, Temp, and Flow | Off | W |
| | DO Signal type | Signal type select | On When Al. Detect, Off When Al. Detect, Scaled Pulse, or Frequency | ON WHEN AL DETECT | W |
| | DO Test | Test output contact | Status High, Status Low, Frequency, Exit | | M |
| | Test Auto Release Time | “Flow simulation”, “DO Test”, “Device Variable Simulation” and “Test output” duration time selection. | 10min, 30min, 60min, 3h, 6h, 12h | 10min | W |
| | Pres Hi Alert Val | High alert value for differential pressure | Set the threshold value for high side alarm | | W |
| | Pres Lo Alert Val | Low alert value for differential pressure | Set the threshold value for low side alarm | | W |
| | Pres Alert Mode | Alert Mode for differential pressure | Off, Hi Al Detect, Lo Al Detect, Hi/Lo Al Detect | Off | W |
| | SP Alert Mode | Alert Mode for static pressure | Off, Hi Al Detect, Lo Al Detect, Hi/Lo Al Detect | Off | W |
| | SP Hi Alert Val | High alert value for static pressure | Set the threshold value for high side alarm | | W |
| | SP Lo Alert Val | Low alert value for static pressure | Set the threshold value for low side alarm | | W |

*1: Handling: R-Read only, W-Read & Write, M-Method, G-Applicable for option code DG6

*2: Max three Burst Messages (Burst Message 1, Burst Message 2, Burst Message 3)

*3: Available only when the device revision is 12 or later

| Function | Label | Item | Contents | Default value | Handling*1 |
|-------------------|--|---|---|----------------------|------------|
| (Process Alerts) | ET Alert Mode | Alert Mode for external temperature | Off, Hi AI Detect,Lo AI Detect, Hi/Lo AI Detect | Off | W |
| | ET Hi Alert Val | High alert value for external temperature | Set the threshold value for high side alarm | 850°C | W |
| | ET Lo Alert Val | Low alert value for external temperature | Set the threshold value for low side alarm | -200°C | W |
| | Flow Alert Mode | Alert Mode for flow | Off, Hi AI Detect,Lo AI Detect, Hi/Lo AI Detect | Off | W |
| | Flow Hi Alert Val | High alert value for flow | Set the threshold value for high side alarm | | W |
| | Flow Lo Alert Val | Low alert value for flow | Set the threshold value for low side alarm | | W |
| Process variables | Pres | Differential pressure value | | | R |
| | SP | Static pressure value | | | R |
| | ET | External temperature value | | | R |
| | Flow | Flow value | | | R |
| | Total Flow | Total flow value | | | R |
| | Pres Limit Status HART 7 | Device variable limit status | Device variable limit status of differential pressure | Not limited | R |
| | Pres Data Quality*3 HART 7 | Device variable process data quality | Device variable process data quality of differential pressure | Good | R |
| | SP Limit Status HART 7 | Device variable limit status | Device variable limit status of static pressure | Not limited | R |
| | SP Data Quality*3 HART 7 | Device variable process data quality | Device variable process data quality of static pressure | Good | R |
| | ET Limit Status HART 7 | Device variable limit status | Device variable limit status of external temperature | Not limited | R |
| | ET Data Quality*3 HART 7 | Device variable process data quality | Device variable process data quality of external temperature | Good | R |
| | Flow Limit Status HART 7 | Device variable limit status | Device variable limit status of flow rate | Not limited | R |
| | Flow Data Quality*3 HART 7 | Device variable process data quality | Device variable process data quality of flow rate | Good | R |
| | Total Flow Limit Status HART 7 | Device variable limit status | Device variable limit status of total flow | Not limited | R |
| | Total Flow Data Quality*3 HART 7 | Device variable process data quality | Device variable process data quality of total flow | Good | R |
| | Pres Update time period HART 7 | Pres Update time period | | 100ms | R |
| | SP Update time period HART 7 | SP Update time period | | 100ms | R |
| | ET Update time period HART 7 | ET Update time period | | 400ms | R |
| | Flow Update time period HART 7 | Flow Update time period | | 100ms | R |
| | Total Flow Update time period HART 7 | Total Flow Update time period | | 1s | R |
| Selftest | Self test | Self-diagnostics | | | M |
| Keypad Input | PV is | Current PV | | | R |
| | Change PV Assgn | Change the allocation to PV | | | M |
| | PV Damp | Damping time constant for PV | | Depends on PV assign | W |
| | PV LRV | Lower range value for PV | | Depends on PV assign | W |
| | PV URV | Upper range value for PV | | Depends on PV assign | W |

*1: Handling: R-Read only, W-Read & Write, M-Method, G-Applicable for option code DG6

*2: Max three Burst Messages (Burst Message 1, Burst Message 2, Burst Message 3)

*3: Available only when the device revision is 12 or later

| Function | Label | Item | Contents | Default value | Handling*1 |
|--------------------------------|----------------------|--|--|---------------|------------|
| Sensor trim | Clear P trim | Reset pressure trim to factory setting | | | M |
| | Clear SP trim | Reset SP trim to factory setting | | | M |
| | Clear ET trim | Reset ET trim to factory setting | | | M |
| | Pres trim | Pressure trim | | | M |
| | SP trim | Static pressure trim | | | M |
| | ET trim | External temperature trim | | | M |
| | Trim Date | Trim date | **/**/** | | W |
| | Trim Desc | Trim description | 16 alphanumerics | | W |
| | Trim Loc | Trim location | 8 alphanumerics | | W |
| Trim Who | Trim person | 8 alphanumerics | | W | |
| SP setup | A/G Select | | | Absolute | W |
| | Atm. Pres Value | | | 101.3 kPa | W |
| | SP H/L Select | | | High | W |
| | SP Damp | Damping time constant for SP | | 2.00s | W |
| | SP LRV | Lower range value for static pressure | | 0.0 MPa | W |
| | SP LSL | Lower sensor limit for static pressure | | | R |
| | SP Min Span | Minimum span for static pressure | | | R |
| | SP URV | Upper range value for static pressure | | | W |
| | SP USL | Upper sensor limit for static pressure | | | R |
| Simulation/ Flow Simulation | Flow Simulation Mode | Simulate Flow Mode | | Off | W |
| | Flow Sim Pres | Differential pressure value for simulation | | 0 | W |
| | Flow Sim Pres Unit | Differential pressure unit for simulation | | kPa | W |
| | Flow Sim SP | Static pressure value for simulation | | 0 | W |
| | Flow Sim SP Unit | Static pressure unit for simulation | | kPa | W |
| | Flow Sim Temp | Temperature value for simulation | | 273 | W |
| | Flow Sim Temp Unit | Temperature unit for simulation | | kPa | W |
| Basic Flow Calc | Flow Calc mode | Flow cauculation mode | Auto Comp. Mode or Basic Mode | | W |
| | Flow Calc Fixed | Calculation fixation value of flow | | | W |
| | Fluid Type | Fluid type | | | W |
| | Ref SP | Reference static pressure | | | |
| | Ref Temp | Reference temperature | | | W |
| | Temp K1 | The first in temperature correction coefficient for liquid | | | W |
| Test key | Test key | Special maintenance parameter | | | M |
| Total Flow | Total Flow Mode | Total flow mode | Reset, Start, Start Cyclic or Stop | | W |
| | Total Flow Unit | Current total flow unit | | | W |
| | Cvt Val | Convert value for total flow base unit | | | W |
| | Freq at 100% | Digital otput fequency at 100% | | | W |
| | Pulse rate | Pulse rate | | | W |
| | Modify Unit | Modify flow base unit | | | M |
| | Set Base Unit | Set total flow base unit | | | M |
| Status | Status group 1 | Device status information for hardware | Display the hardware error | | R |
| | Status group 2 | Device status information for hardware | Display the hardware error | | R |
| | Status group 3 | Device status information for process | Display the process error (Out of specification) | | R |
| | Status group 4 | Device status information for process | Display the process error (Out of setting range) | | R |

*1: Handling: R-Read only, W-Read & Write, M-Method, G-Applicable for option code DG6

*2: Max three Burst Messages (Burst Message 1, Burst Message 2, Burst Message 3)

*3: Available only when the device revision is 12 or later

| Function | Label | Item | Contents | Default value | Handling*1 |
|--|--|--|---|-------------------|------------|
| (Status) | Status group 5 | Device status information for process | Display the process error (Alarm) | | R |
| | Status group 6 | Device status information for data | Display the setting error | | R |
| | Status group 7 | Device status information for data | Display the setting error | | R |
| | Status group 8 | Device status information for data | Display the setting error and process error (Alarm) | | R |
| | Status group 9 | Device status information for data | Display the diagnostic alarm | | R |
| | Status group 10 | Device status information for data | Display the diagnostic alarm | | R |
| | Status group 11 HART 7 | Device status information for data | Display the simulation mode | | R |
| | Ext dev status / Extended Device Status HART 7 | Extended Device Status | | | R |
| Device Diagnostic Status 0 / Standardized Status 0 HART 7 | Diagnostic Status | | | R | |
| Tag | Tag | Tag number | 16 alphanumerics | As specified | W |
| | Long tag HART 7 | Long tag | Max 32 alphanumerics | As specified | W |
| Temperature | Amp temp | Amplifier temperature | | | R |
| | Cap temp | Capsule temperature | | | R |
| Units | ET Unit | External temperature unit | | | W |
| | Flow Unit | Flow unit | | | W |
| | Pres Unit | Differential pressure unit | | | W |
| | PV Unit | PV unit | | | W |
| | SP Unit | Static pressure unit | | | W |
| | SV Unit | SV unit | | | W |
| | Total Flow Unit | Total flow unit | | | W |
| | TV Unit | TV unit | | | W |
| | 4V Unit HART 5 | 4V unit | | | W |
| QV Unit HART 7 | QV unit | | | W | |
| Write protection menu | Enable wrt 10min | Write protection release | 8 alphanumerics | | M |
| | New password | User set password for write protection | 8 alphanumerics | | M |
| | Write protect | Write protection indicator | Yes or No | No | R |
| Process variables | Change PV Assign | Change the allocation to PV | | | M |
| | PV | PV value | Unit specified in PV Unit | | R |
| | PV is | Current PV | | | R |
| | PV % HART 5 | PV value in % | -2.50 to 110.00% | | R |
| | PV AO HART 5 | Analog output current | 3.8000 to 21.6000 mA | | R |
| | Engr Disp | User scaled value | Unit specified in Set Engr Unit | | R |
| | Engr exp | Exponents | x1, x10, x100, or x1000 | As specified or - | W |
| | Engr Unit | User set engineering unit | Unit specified in Set Engr Unit | | R |
| | Change SV Assgn | Change the allocation to SV | | | M |
| | SV | SV value | Unit specified in SV Unit | | R |
| | SV is | Current SV | | | R |
| | Change TV Assgn | Change the allocation to TV | | | M |
| | TV | TV value | | | R |
| | TV is | Current TV | | | R |
| | Change 4V Assgn HART 5 | Change the allocation to 4V | | | M |
| | Change QV Assgn HART 7 | Change the allocation to QV | | | M |
| | 4V HART 5 | 4V value | Unit specified in 4V Unit | | R |
| | QV HART 7 | QV value | Unit specified in QV Unit | | R |
| | 4V is HART 5 | Current 4V | | | R |
| | QV is HART 7 | Current QV | | | R |

*1: Handling: R-Read only, W-Read & Write, M-Method, G-Applicable for option code DG6

*2: Max three Burst Messages (Burst Message 1, Burst Message 2, Burst Message 3)

*3: Available only when the device revision is 12 or later

| Function | Label | Item | Contents | Default value | Handling*1 |
|----------------------------|---|--|---|------------------------|------------|
| (Process variables) | PV Limit Status <small>HART 7</small> | Device variable limit status | Device variable limit status of PV | Not limited | R |
| | PV Data Quality*3 <small>HART 7</small> | Device variable process data quality | Device variable process data quality of PV | Good | R |
| | SV Limit Status <small>HART 7</small> | Device variable limit status | Device variable limit status of SV | Not limited | R |
| | SV Data Quality*3 <small>HART 7</small> | Device variable process data quality | Device variable process data quality of SV | Good | R |
| | TV Limit Status <small>HART 7</small> | Device variable limit status | Device variable limit status of TV | Not limited | R |
| | TV Data Quality*3 <small>HART 7</small> | Device variable process data quality | Device variable process data quality of TV | Good | R |
| | QV Limit Status <small>HART 7</small> | Device variable limit status | Device variable limit status of QV | Not limited | R |
| | QV Data Quality*3 <small>HART 7</small> | Device variable process data quality | Device variable process data quality of QV | Good | R |
| | % Range | % of range value (PV value in %) | -2.50 to 110.00% | | R |
| | % Range Limit Status <small>HART 7</small> | Device variable limit status | Device variable limit status of % Range | Not limited | R |
| | % Range Data Quality*3 <small>HART 7</small> | Device variable process data quality | Device variable process data quality of % Range | Good | R |
| | Loop Current <small>HART 7</small> | Loop current value (Analog Output Current) | 3.8 to 21.6 mA | | R |
| | Loop Current Limit Status <small>HART 7</small> | Device variable limit status | Device variable limit status of Loop Current (mA) | Not limited | R |
| | Loop Current Data Quality*3 <small>HART 7</small> | Device variable process data quality | Device variable process data quality of Loop Current (mA) | Good | R |
| | Device Variable Simulation | Simulate <small>HART 7</small> | Execution of device variable simulation | Execute the simulation | |
| Advanced diagnostic (ILBD) | Diag Applicable | Applicable blockage detection | Disabled or Enabled | | RG |
| | Diag DPComp | fDP compensation selection | Compensation or Non-compensation | Compensation | WG |
| | Diag Error | Results detected by ILBD or Heat trace monitoring | | 0x0000 | RG |
| | Lim fDPmax | Upper limit for Ratio fDP | | 3 | WG |
| | Lim fDPmin | Lower limit for Ratio fDP | | 0.3 | WG |
| | Lim fSPImax | Upper limit for Ratio fSPI | | 5 | WG |
| | Lim fSPImin | Lower limit for Ratio fSPI | | 0.5 | WG |
| | Lim fSPHmax | Upper limit for Ratio fSPH | | 5 | WG |
| | Lim fSPHmin | Lower limit for Ratio fSPH | | 0.5 | WG |
| | Lim BlkFmax | Upper limit for BlkF | | 0.6 | WG |
| | Lim BlkFmin | Lower limit for BlkF | | -0.6 | WG |
| | Lim DPavgmax | Upper limit for DPavg | | 1 | WG |
| | Lim DPavgmin | Lower limit for DPavg | | 0.05 | WG |
| | Diag Mode | ILBD operation mode | Stop, Calculation, or Reference | Stop | WG |
| | Diag Option | Alarm masking | | 0x08FC | WG |
| | Diag Out Option | Output mode of 4-20mA when an advanced diagnostic alarm is generated | Off, Burnout, or Fall back | Off | WG |
| | Diag Fixed Out Val | 4-20 mA output when an advanced diagnostic alarm is generated | 3.8000 to 21.6000 mA | 21.6 mA | WG |
| Diag Period | Sampling period per one Diag count | | 180 sec | WG | |
| Diag Description | Memo field | 32 alphanumerics | | WG | |
| fDP | Average value of the sum of squares of differential pressure/ pressure fluctuations | | | RG | |
| fDP Status | Status of fDP | | | RG | |

*1: Handling: R-Read only, W-Read & Write, M-Method, G-Applicable for option code DG6
 *2: Max three Burst Messages (Burst Message 1, Burst Message 2, Burst Message 3)
 *3: Available only when the device revision is 12 or later

| Function | Label | Item | Contents | Default value | Handling*1 |
|---|-----------------------|---|----------|---------------|------------|
| (Advanced diagnostic (ILBD)) | fSPI | Average value of the sum of squares of low-pressure-side static pressure fluctuations | | | RG |
| | fSPI Status | Status of fSPI | | | RG |
| | fSPH | Average value of the sum of squares of high-pressure-side static pressure fluctuations | | | RG |
| | fSPH Status | Status of fSPH | | | RG |
| | Ref fDP | Reference value of fDP | | | WG |
| | Ref fDP Status | Status of Reference fDP | | | RG |
| | Ref fSPI | Reference value of fSPI | | | WG |
| | Ref fSPI Status | Status of Reference fSPI | | | RG |
| | Ref fSPH | Reference value of fSPH | | | WG |
| | Ref fSPH Status | Status of Reference fSPH | | | RG |
| | Ref BlkF | Reference value of BlkF | | | WG |
| | Ref BlkF Status | Status of Reference BlkF | | | RG |
| | Ref DPAvg | Reference value of DPAvg | | | WG |
| | Ref DPAvg Status | Status of Reference DPAvg | | | RG |
| | Ref Lim fDPmin | Lower limit of fDP | | 7.0E-10 | WG |
| | Ref Lim fSPmin | Lower limit of fSPI and fSPH | | 1.0E-09 | WG |
| | Ref Lim BlkFmax | Upper limit of BlkF | | 0.5 | WG |
| | Diag Supp Count | Detection count to generate an alarm | | 3 | WG |
| | Ratio fDP | SQRT (fDP/Ref fDP). | | | RG |
| | Ratio fDP Status | Status of Ratio fDP | | | RG |
| | Ratio fSPI | SQRT (fSPI/Ref fSPI). | | | RG |
| | Ratio fSPI Status | Status of Ratio fSPI | | | RG |
| | Ratio fSPH | SQRT (fSPH/Ref fSPH). | | | RG |
| | Ratio fSPH Status | Status of Ratio fSPH | | | RG |
| | BlkF | Blockage degree characterized in comparison of high-pressure side and low-pressure side pressure fluctuation values | | | RG |
| | BlkF Status | Status of BlkF | | | RG |
| | DPAvg | Ratio of the average of differential pressure/pressure to the maximum span of an EJX transmitter. | | | RG |
| DPAvg Status | Status of DPAvg | | | RG | |
| CRatio fDP | Compensated fDP | | | RG | |
| CRatio fDP Status | Status of CRatio fDP | | | RG | |
| NRatio fDP | Non-compensated fDP | | | RG | |
| NRatio fDP Status | Status of NRatio fDP | | | RG | |
| Advanced diagnostic (Heat Trace Monitoring) | Flg temp Coef | | | 0 | WG |
| | Flg temp Hi Alarm Val | Upper limit of Flange temperature | | 120°C (deg C) | WG |
| | Flg temp Lo Alarm Val | Lower limit of Flange temperature | | -40°C (deg C) | WG |
| | Flg temp | Calculated flange temperature value | | | RG |
| Optional function | Option Password | Optional function activation password | | (Space) | W |

*1: Handling: R-Read only, W-Read & Write, M-Method, G-Applicable for option code DG6

*2: Max three Burst Messages (Burst Message 1, Burst Message 2, Burst Message 3)

*3: Available only when the device revision is 12 or later

| Function | Label | Item | Contents | Default value | Handling*1 |
|---|----------------------------------|---|---|--------------------------------------|------------|
| User Flow Parameters (Setting information for Auto Compensation Mode) *3 HART 7 | PD Type & Desc | Primary Device Type and Description | User Flow Parameters are information that users input on FSA120 for flow configuration. | Orifice Corner Taps [ISO5167-1 1991] | R |
| | PD Desc (User Defined) | Primary Device Description (User Defined Mode) | For the settings by FSA120, refer to FSA120 Instruction Manual (IM01C25R51-01E). In the following cases, User Flow Parameter settings are indefinite. • Basic Mode for Mass Flow Measurement • Multi Sensing | | R |
| | PD Model Type | Primary Device Model Type | | | R |
| | Discharge/Flow Coef Option | Flow/Discharge coefficient Option and Constant value | | Constant | R |
| | Discharge/Flow Coef Constant | | | 0 | R |
| | Gas Exp Factor Option | Gas Expansion Factor Option and Constant value | | Constant | R |
| | Gas Exp Factor Constant 1 | | | 0 | R |
| | PD Diameter (d) | Primary Device Sizing and Unit | | 0 | R |
| | PD Diameter Unit | | | mm | R |
| | PD Temperature | Temperature and Unit when measuring Primary Device size | | 20 | R |
| | PD Temperature Unit | | | degC | R |
| | PD Material | Primary Device Material and Thermal Expansion Factor | | 304 Stainless Steel | R |
| | PD Material Thermal Exp Factor | | | 0 m/m/degC | R |
| | Pipe Diameter (D) | Pipe Sizing and Unit | | 0 | R |
| | Pipe Diameter Unit | | | mm | R |
| | Pipe Temperature | Temperature and Unit when measuring piping size | | 20 | R |
| | Pipe Temperature Unit | | | degC | R |
| | Pipe Material | Pipe Material and Thermal Expansion Factor | | Carbon Steel | R |
| | Pipe Material Thermal Exp Factor | | | 0 m/m/degC | R |
| | Num of Points | Number of points in Coefficient table | | 2 | R |
| | Reynolds Num #1 ~ #20 | Reynolds Number #1 ~ #20 | | 0 | R |
| | Discharge/Flow Coef #1 ~ #20 | Define Discharge/Flow Coefficient #1 ~ #20 as Function of Reynolds Number | | 0 | R |
| | Gas Exp Factor Constant 1 | User defined Constant value of Gas Expansion Factor | | 0 | R |
| | Gas Exp Factor Constant 2 | | | 0 | R |
| | Fluid Type | Fluid Type | | Gas or Steam | R |
| | Fluid Category | Fluid Category | | Natural Gas | R |
| | Fluid Name/Method | Fluid Name/Method | | AGA8 Detail Characterization Method | R |
| | Fluid Name/Method (custom) | Customized Fluid Name/Method | | | R |

*1: Handling: R-Read only, W-Read & Write, M-Method, G-Applicable for option code DG6

*2: Max three Burst Messages (Burst Message 1, Burst Message 2, Burst Message 3)

*3: Available only when the device revision is 12 or later

| Function | Label | Item | Contents | Default value | Handling*1 | |
|---|-----------------------------------|---|--|---------------------------|------------|---|
| (User Flow Parameters) | CH4 Methane Mole | Each Gas Mole in case of AGA8 Detail Characterization Method or ISO12213 molar-composition analysis | User Flow Parameters are information that users input on FSA120 for flow configuration. For the settings by FSA120, refer to FSA120 Instruction Manual (IM01C25R51-01E). In the following cases, User Flow Parameter settings are indefinite. • Basic Mode for Mass Flow Measurement • Multi Sensing | 0% | R | |
| | N2 Nitrogen Mole | | | 0% | R | |
| (Setting information for Auto Compensation Mode) *3 | CO2 Carbon Dioxide Mole | | | 0% | R | |
| | C2H6 Ethane Mole | | | 0% | R | |
| | C3H8 Propane Mole | | | 0% | R | |
| | H2O Water Mole | | | 0% | R | |
| | HART 7 | | | H2S Hydrogen Sulfide Mole | 0% | R |
| | | | | H2 Hydrogen Mole | 0% | R |
| | CO Carbon Monoxide Mole | | | 0% | R | |
| | O2 Oxygen Mole | | | 0% | R | |
| | C4H10 i-Butane Mole | | | 0% | R | |
| | C4H10 n-Butane Mole | | | 0% | R | |
| | C5H12 i-Pentane Mole | | | 0% | R | |
| | C5H12 n-Pentane Mole | | | 0% | R | |
| | C6H14 n-Hexane Mole | | | 0% | R | |
| | C7H16 n-Heptane Mole | | | 0% | R | |
| | C8H18 n-Octane Mole | | | 0% | R | |
| | C9H20 n-Nonane Mole | | | 0% | R | |
| | C10H22 n-Decane Mole | | | 0% | R | |
| | He Helium Mole | | | 0% | R | |
| Ar Argon Mole | 0% | R | | | | |
| | Real Gas Relative Density | Real Gas Relative Density | 0 | R | | |
| | Volumetric Gross Heating Value | Volumetric Gross Heating Value and Unit | 0 | R | | |
| | Volumetric Gross Heating Val Unit | | MJ/m3 | R | | |
| | Carbon Dioxide (CO2) Mole | Each Gas Mole in case of AGA8 Gross Characterization Method or ISO12213 physical properties | 0% | R | | |
| | Nitrogen (N2) Mole | | 0% | R | | |
| | Hydrogen (H2) Mole | | 0% | R | | |
| | Carbon Monoxide (CO) Mole | | 0% | R | | |
| | Operating SP Lower Value | Static Pressure Lower Value in Fluid Operating Range | 0 | R | | |
| | Operating SP Upper Value | Static Pressure Upper Value in Fluid Operating Range | 0 | R | | |

*1: Handling: R-Read only, W-Read & Write, M-Method, G-Applicable for option code DG6

*2: Max three Burst Messages (Burst Message 1, Burst Message 2, Burst Message 3)

*3: Available only when the device revision is 12 or later

| Function | Label | Item | Contents | Default value | Handling*1 |
|--|--|---|--|---------------|------------|
| (User Flow Parameters) (Setting information for Auto Compensation Mode) *3 HART 7 | Operating SP Unit | Static Pressure Unit in Fluid Operating Range | User Flow Parameters are information that users input on FSA120 for flow configuration. For the settings by FSA120, refer to FSA120 Instruction Manual (IM01C25R51-01E). In the following cases, User Flow Parameter settings are indefinite. • Basic Mode for Mass Flow Measurement • Multi Sensing | kPa abs | R |
| | Atmospheric Pressure | Atmospheric Pressure Value in Fluid Operating Range | | 101.325 | R |
| | Atmospheric Pressure Unit | Atmospheric Pressure Unit in Fluid Operating Range | | kPa abs | R |
| | Operating Temp Lower Range | Temperature Lower Value in Fluid Operating Range | | 0 | R |
| | Operating Temp Upper Range | Temperature Upper Value in Fluid Operating Range | | 0 | R |
| | Operating Temp Unit | Temperature Unit in Fluid Operating Range | | degC | R |
| | Ref Condition Pressure | Pressure Value in Reference Conditions | | 0 | R |
| | Ref Condition Pres Unit | Pressure Unit in Reference Conditions | | kPa abs | R |
| | Ref Condition Temperature | Temperature Value in Reference Conditions | | 0 | R |
| | Ref Condition Temp Unit | Temperature Unit in Reference Conditions | | degC | R |
| | Density Unit | Density Unit | | kg/m3 | R |
| | Density Table 1 ~ 12 | Density Table Data 1 ~ 12 | | 0 | R |
| | Viscosity Unit | Viscosity Unit | | Pa s | R |
| | Viscosity Table 1 ~ 4 | Viscosity Table Data 1 ~ 12 | | 0 | R |
| | Molecular Weight | Molecular Weight | | 0 | R |
| Isentropic Exponent | Isentropic Exponent | 0 | R | | |
| Reference Density | Reference Density (Standard or Normal) | 0 | R | | |
| Service Information*3 HART 7 | Info 01 ~ Info 65 | Service Information 01 ~ 65 | This Service Information is used for only YOKOGAWA service member. | | R |

*1: Handling: R-Read only, W-Read & Write, M-Method, G-Applicable for option code DG6

*2: Max three Burst Messages (Burst Message 1, Burst Message 2, Burst Message 3)

*3: Available only when the device revision is 12 or later

6. Procedures to Call Parameter

| Function | Label | DD (HART 7) EJX910 HART 7 DTM (HART 7) EJX910 FDT2.0 HART 7 DTM (HART 7) | DD (HART 5) EJX910 HART DTM (HART 5) EJX910 FDT2.0 HART DTM (HART 5) | EJX910 V2.1 DTM (HART 5) |
|--------------------|------------------------------------|---|---|---------------------------------|
| Analog output | AO alm typ | [Root Menu] → Detailed setup → Output condition → Analog output → | | Configuration → Analog output → |
| | AO lower limit | | | |
| | AO upper limit | | | |
| | Auto recover | | | |
| Analog output trim | Clear D/A trim | [Root Menu] → Maintenance → Analog output trim → | [Root Menu] → Diag/Service → Calibration → Analog output trim → | Calibration → |
| | D/A trim | | | |
| | Scaled D/A trim | | | |
| | Channel flags (HART 7) | [Root Menu] → Detailed setup → Output condition → Analog output → | --- | |
| Burst mode | Burst mode | [Root Menu] → Detailed setup → Output condition → HART output → Burst Condition → Burst Message 1, 2 or 3 → | [Root Menu] → Detailed setup → Output condition → HART output → | Configuration → HART → |
| | Burst option (HART 5) | --- | | |
| | Burst Xmtr Vals (HART 5) | | | |
| | Burst Command (HART 7) | [Root Menu] → Detailed setup → Output Condition → HART Output → Burst Condition → Burst Message 1, 2 or 3 → | --- | |
| | Burst Variable Code (HART 7) | [Root Menu] → Detailed setup → Output Condition → HART Output → Burst Condition → Burst Message 1, 2 or 3 → Burst Variables → | | |
| | Set Burst Trigger (HART 7) | [Root Menu] → Detailed setup → Output Condition → HART Output → Burst Condition → Burst Message 1, 2 or 3 → | | |
| | Set Burst Period (HART 7) | | | |
| | Burst Msg Trigger Mode (HART 7) | | | |
| | Burst Trigger Level (HART 7) | | | |
| | Burst Trigger Units (HART 7) | | | |
| | Update Period (HART 7) | | | |
| | Max Update Period (HART 7) | | | |

| Function | Label | DD (HART 7) EJX910 HART 7 DTM (HART 7) EJX910 FDT2.0 HART 7 DTM (HART 7) | DD (HART 5) EJX910 HART DTM (HART 5) EJX910 FDT2.0 HART DTM (HART 5) | EJX910 V2.1 DTM (HART 5) |
|--------------------|--|---|---|--------------------------|
| (Burst mode) | Flow Update time period (HART 7) Pres Update time period (HART 7) SP Update time period (HART 7) ET Update time period (HART 7) Total Flow Update time period (HART 7) | [Root Menu] → Detailed setup → Output Condition → HART Output → Burst Condition → Burst Condition → | --- | |
| Event Notification | Control / Mode (HART 7) Device Status Mask (HART 7) Status group 1 Mask to 11 Mask (HART 7) Ext dev status Mask / Extended Device Status Mask (HART 7) Diagnostic Status 0 Mask / Standardized Status 0 Mask (HART 7) Set Event Notification Timing (HART 7) Retry Time / Retry Rate (HART 7) Max Update Time / Max Update Rate (HART 7) Debounce Interval (HART 7) Acknowledge Event Notification (HART 7) Status (HART 7) Event Number (HART 7) Time First Unack Event Triggered (HART 7) Latched Cfg chng count (HART 7) Latched Device Status (HART 7) Latched Status group 1 to 11 (HART 7) Latched Ext dev status (HART 7) Latched Device Diagnostic Status 0 (HART 7) | [Root Menu] → Detailed setup → Output condition → HART output → Event Notification → Event Condition → [Root Menu] → Detailed setup → Output condition → HART output → Event Notification → Event Mask → [Root Menu] → Detailed setup → Output condition → HART output → Event Notification → Event Condition → [Root Menu] → Detailed setup → Output condition → HART output → Event Notification → Knowledge → | --- | |

| Function | Label | DD (HART 7) EJX910 HART 7 DTM (HART 7) EJX910 FDT2.0 HART 7 DTM (HART 7) | DD (HART 5) EJX910 HART DTM (HART 5) EJX910 FDT2.0 HART DTM (HART 5) | EJX910 V2.1 DTM (HART 5) |
|---|---|---|---|--|
| Date | Date | [Root Menu] → Basic setup → Device information → | | Configuration → Device Information1 → |
| Descriptor | Descriptor | | | |
| Device information | Country HART 7 | [Root Menu] → Detailed setup → Device information → Additional info → | --- | |
| | Dev id | [Root Menu] → Detailed setup → Device information → Additional info → | [Root Menu] → Detailed setup → Device information → Field device info → Additional info → | Configuration → HART→ |
| | Distributor | | | --- |
| | Extra No | | | Configuration → Device Information2 → |
| | Final asmbly num | | | Configuration → Device Information1 → |
| | Mftr Date | | | Configuration → Device Information2 → |
| | PT100 serial No. | | | |
| | Serial No | | | |
| | Style No | | | |
| | Ext SW | [Root Menu] → Detailed setup → Device information → Field device info → Field device info → | | Configuration → Device Information1 → |
| | Model 1 or MS Code 1 | [Root Menu] → Detailed setup → Device information → Field device info → Field device info → | | Configuration → Device Information2 → |
| | Model 2 or MS Code 2 | | | |
| | Model 3 or MS Code 3 | | | |
| | Fld dev rev | [Root Menu] → Detailed setup → Device information → Field device info → Revision #'s → | | Configuration → HART→ |
| | Universal rev | | | |
| | Software rev | | | Configuration → Device Information1 → |
| | Drain vent matl | [Root Menu] → Detailed setup → Device information → Sensor information → | | Configuration → Physical Information → |
| | Fill fluid | | | |
| | Gasket matl | | | |
| | Isoltr matl | | | |
| | Num of RS | | | |
| | Process Conn matl | | | |
| | Process Conn size | | | |
| Process Conn type | | | | |
| RS fill fluid | | | | |
| RS isoltr matl | | | | |
| RS type | | | | |
| Cfg chng count HART 7 | [Root Menu] → Diag/Service → Status → | --- | | |
| Reset Cfg chng flag HART 7 | | | | |
| Device Profile HART 7 | [Root Menu] → Detailed setup → Device information → Additional info → | | | |
| Max dev vars HART 7 | | | | |
| Model | [Root Menu] → Basic setup → Device information → | | Configuration → Device Information1 → | |
| Meas. Func. (Device Revision is 12 or later) | [Root Menu] → Detailed setup → Device information → Field device info → | --- | | |

| Function | Label | DD (HART 7) EJX910 HART 7 DTM (HART 7) EJX910 FDT2.0 HART 7 DTM (HART 7) | DD (HART 5) EJX910 HART DTM (HART 5) EJX910 FDT2.0 HART DTM (HART 5) | EJX910 V2.1 DTM (HART 5) |
|--|---|---|---|---|
| Display setup | Bar Indicator | [Root Menu] → Detailed setup → Display condition → Disp condition → | | Configuration → Local Display → |
| | Chg power on info or Power on info | [Root Menu] → Detailed setup → Display condition → Disp condition → | [Root Menu] → Detailed setup → Display condition → Others → | |
| | Disp1 or Disp Out1 | [Root Menu] → Detailed setup → Display condition → Disp select → | | |
| | Disp2 or Disp Out2 | | | |
| | Disp3 or Disp Out3 | | | |
| | Disp4 or Disp Out4 | | | |
| | Disp % Reso | [Root Menu] → Detailed setup → Display condition → Disp condition → | | |
| | Engr exp | [Root Menu] → Detailed setup → Display condition → Engr disp range → | | |
| | Engr LRV | | | |
| | Engr point | | | |
| | Engr URV | | | |
| | Engr Unit | | | |
| | Modify Engr Unit | | | |
| | Set Engr Unit | | | |
| | ET disp point | [Root Menu] → Detailed setup → Display condition → Disp condition → | | |
| | Flow disp point | | | |
| Pres disp point | | | | |
| SP disp point | | | | |
| TF disp point | | | | |
| Squawk HART 7 | [Root Menu] → Diag/Service → Test → | --- | | |
| DP setup | Pres Damp | [Root Menu] → Detailed setup → Signal condition → Pres Setup (or DP Setup) → | | Configuration → Pressure Sensor → |
| | Pres Min Span | | | |
| | Pres LRV | | | |
| | Pres LSL | | | |
| | Pres URV | | | |
| | Pres USL | | | |
| Error log | Error log Clear | [Root Menu] → Diag/Service → Error log → | | Diag and Service → Service → |
| | Error log view | | | |
| ET setup | ET Damp | [Root Menu] → Detailed setup → Signal condition → ET Setup → | | Configuration → External Temperature Sensor → |
| | ET Fixed | | | |
| | ET Min Span | | | |
| | ET LRV | | | |
| | ET LSL | | | |
| | ET URV | | | |
| | ET USL | | | |
| | Fixed ET Val | | | |
| Flow setup | Flow Damp | [Root Menu] → Detailed setup → Signal condition → Flow Setup → | | Configuration → Flow → |
| | Flow LRV | | | |
| | Flow URV | | | |
| Loop test | Loop test | [Root Menu] → Diag/Service → Test → | | Diag and Service → Service → |
| | Test Auto Release Time | | | |
| Low cut | Low cut | [Root Menu] → Basic setup → Others → | | Configuration → Analog Output → |
| | Low cut mode | | | |
| Master test | Master test | [Root Menu] → Diag/Service → Test → | | Diag and Service → Service → |
| Message | Message | [Root Menu] → Basic setup → Device information → | | Configuration → Device Information1 → |
| Number of preambles | Num req preams | [Root Menu] → Detailed setup → Output condition → HART output → | | Configuration → HART → |
| | Num resp preams HART 7 | [Root Menu] → Detailed setup → Output condition → HART output → | --- | |

| Function | Label | DD (HART 7) EJX910 HART 7 DTM (HART 7) EJX910 FDT2.0 HART 7 DTM (HART 7) | DD (HART 5) EJX910 HART DTM (HART 5) EJX910 FDT2.0 HART DTM (HART 5) | EJX910 V2.1 DTM (HART 5) |
|---|---|---|---|-----------------------------------|
| Piping orientation | H/L Swap | [Root Menu] → Basic setup → Others → | | Configuration → Pressure Sensor → |
| Poll address | Poll addr | [Root Menu] → Detailed setup → Output condition → HART output → | | Configuration → HART → |
| Process Alerts | Digital Output | [Root Menu] → Detailed setup → Output condition → Process Alerts → DO Config → | | Configuration → Process Alerts → |
| | DO Select | | | |
| | DO Signal type | | | Diag and Service → Service → |
| | DO Test | | | |
| | DO Frequency | [Root Menu] → Detailed setup → Output condition → Process Alerts → Pres Alert → | | Configuration → Total Flow → |
| | Pres Alert Mode | | | |
| | Pres Hi Alert Val | | | |
| | Pres Lo Alert Val | [Root Menu] → Detailed setup → Output condition → Process Alerts → SP Alert → | | Configuration → Process Alerts → |
| | SP Alert Mode | | | |
| | SP Hi Alert Val | | | |
| | SP Lo Alert Val | [Root Menu] → Detailed setup → Output condition → Process Alerts → ET Alert → | | |
| | ET Alert Mode | | | |
| | ET Hi Alert Val | | | |
| | ET Lo Alert Val | [Root Menu] → Detailed setup → Output condition → Process Alerts → Flow Alert → | | |
| Flow Alert Mode | | | | |
| Flow Hi Alert Val | | | | |
| Flow Lo Alert Val | [Root Menu] → Process variables → View fld dev vars → | | Process Variables → | |
| Flow Lo Alert Val | | | | |
| Flow Lo Alert Val | | | | |
| Process variables | Pres | [Root Menu] → Process variables → Device variables and Status → | | --- |
| | SP | | | |
| | ET | | | |
| | Flow | | | |
| | Total Flow | | | |
| | Pres Limit Status HART 7 | | | |
| | Pres Data Quality HART 7 | | | |
| | SP Limit Status HART 7 | | | |
| | SP Data Quality HART 7 | | | |
| | ET Limit Status HART 7 | | | |
| | ET Data Quality HART 7 | | | |
| | Flow Limit Status HART 7 | | | |
| | Flow Data Quality HART 7 | | | |
| | Total Flow Limit Status HART 7 | | | |
| Total Flow Data Quality HART 7 | | | | |
| Self test | Self test | [Root Menu] → Diag/Service → Test → | | --- |

| Function | Label | DD (HART 7) EJX910 HART 7 DTM (HART 7) EJX910 FDT2.0 HART 7 DTM (HART 7) | DD (HART 5) EJX910 HART DTM (HART 5) EJX910 FDT2.0 HART DTM (HART 5) | EJX910 V2.1 DTM (HART 5) |
|--------------------|-----------------------------------|--|---|---|
| Sensor trim | Clear P trim | [Root Menu] → Maintenance → Pres sensor trim → | [Root Menu] → Diag/Service → Calibration → Pres sensor trim → | Calibration → |
| | Clear SP trim | [Root Menu] → Maintenance → SP sensor trim → | [Root Menu] → Diag/Service → Calibration → SP sensor trim → | Calibration → |
| | Clear ET trim | [Root Menu] → Maintenance → ET sensor trim → | [Root Menu] → Diag/Service → Calibration → ET sensor trim → | Calibration → |
| | Pres trim | [Root Menu] → Maintenance → Pres sensor trim → | [Root Menu] → Diag/Service → Calibration → Pres sensor trim → | Calibration → |
| | SP trim | [Root Menu] → Maintenance → SP sensor trim → | [Root Menu] → Diag/Service → Calibration → SP sensor trim → | Calibration → |
| | ET trim | [Root Menu] → Maintenance → ET sensor trim → | [Root Menu] → Diag/Service → Calibration → ET sensor trim → | Calibration → |
| | Trim Date | [Root Menu] → Maintenance → Trim info. → | [Root Menu] → Diag/Service → Calibration → Trim info. → | Calibration → |
| | Trim Desc | | | |
| Trim Loc | | | | |
| Trim Who | | | | |
| SP setup | A/G Select | [Root Menu] → Detailed setup → Signal condition → SP Setup → | | Configuration → Static Pressure Sensor → |
| | Atm.Pres.Value | | | |
| | SP H/L Select | | | |
| | SP Damp | | | |
| | SP LRV | | | |
| | SP LSL | | | |
| | SP Min Span | | | |
| | SP URV | | | |
| | SP USL | | | |
| | Simulation/ Flow Simulation | | | |
| Flow Sim Pres Unit | | | | |
| Flow Sim Pres | | | | |
| Flow Sim SP Unit | | | | |
| Flow Sim SP | | | | |
| Flow Sim Temp Unit | | | | |
| Flow Sim Temp | | | | |
| Basic Flow Calc | Flow Calc Mode | [Root Menu] → Detailed setup → Basic Flow Calc → | | Configuration → Basic Flow Calc → |
| | Flow Calc Fixed | | | |
| | Fluid Type | | | |
| | Ref SP | | | |
| | Ref Temp | | | |
| | Temp K1 | | | |
| Total Flow | Total Flow Mode | [Root Menu] → Detailed setup → Signal condition → Total Flow → | | Configuration → Total Flow → |
| | Total Flow Unit | | | |
| | Freq at 100% | | | |
| | Pulse rate | | | |
| | Cvt Val | [Root Menu] → Detailed setup → Signal condition → Total Flow → Config User Unit → | | |
| | Modify Unit | | | |
| | Set Base Unit | | | |

| Function | Label | DD (HART 7) EJX910 HART 7 DTM (HART 7) EJX910 FDT2.0 HART 7 DTM (HART 7) | DD (HART 5) EJX910 HART DTM (HART 5) EJX910 FDT2.0 HART DTM (HART 5) | EJX910 V2.1 DTM (HART 5) |
|-----------------------------|---|---|---|--|
| Status | Status group 1 | [Root Menu] → Diag/Service → Status → | | Device Status → |
| | Status group 2 | | | |
| | Status group 3 | | | |
| | Status group 4 | | | |
| | Status group 5 | | | |
| | Status group 6 | | | |
| | Status group 7 | | | |
| | Status group 8 | | | |
| | Status group 9 | | | |
| | Status group 10 | | | |
| | Status group 11 HART 7 | [Root Menu] → Diag/Service → Status → | --- | |
| | Ext dev status / Extended Device Status HART 7 | [Root Menu] → Diag/Service → Status → | --- | |
| | Device Diagnostic Status 0 / Standardized Status 0 HART 7 | | | |
| Tag | Tag | [Root Menu] → Basic setup → Device information → | [Root Menu] → Basic setup → Tag → | Easy Setup → or Configuration → HART → |
| | Long tag HART 7 | | --- | |
| Temperature | Amp temp | [Root Menu] → Process variables → View fld dev vars → | | Configuration → Process Input → |
| | Cap temp | | | |
| Units | ET Unit | [Root Menu] → Basic setup → Units → | | Configuration → External Temperature Sensor → |
| | Flow Unit | [Root Menu] → Basic setup → Units → | | Configuration → Flow → |
| | Pres Unit | [Root Menu] → Basic setup → Units → | | Configuration → Pressure Sensor → |
| | SP Unit | [Root Menu] → Basic setup → Units → | | Configuration → Static Pressure Sensor → |
| | Total Flow Unit | [Root Menu] → Basic setup → Units → | | Configuration → Total Flow → |
| Write protection menu | Enable wrt 10min | [Root Menu] → Detailed setup → Write protect menu → | [Root Menu] → Detailed setup → Device information → Field device info → Write protect menu → | Write Protect → |
| | New password | | | |
| | Write Protect | | | |
| Process variables | Change PV Assgn | [Root Menu] → Process variables → Output vars → PV → | | Configuration → Output Variables → |
| | PV | [Root Menu] → Process variables → PV → | [Root Menu] → Process Variables → Variables | |
| | PV is | [Root Menu] → Process variables → Output vars → PV → | | |
| | PV% (Flow %, Pres %, SP % or ET %) HART 5 | --- | [Root Menu] → Process variables → Variables → | Process Variables → |
| | PV AO (Flow AO, Pres AO, SP AO or ET AO) HART 5 | | | |
| | Engr Disp | [Root Menu] → Process variables → Engr disp → | [Root Menu] → Process variables → Variables → | |

| Function | Label | DD (HART 7) EJX910 HART 7 DTM (HART 7) EJX910 FDT2.0 HART 7 DTM (HART 7) | DD (HART 5) EJX910 HART DTM (HART 5) EJX910 FDT2.0 HART DTM (HART 5) | EJX910 V2.1 DTM (HART 5) |
|----------------------------|---|---|---|------------------------------------|
| (Process variables) | Change SV Assgn | [Root Menu] → Process variables → Output vars → SV → | --- | Configuration → Output Variables → |
| | SV | | | |
| | SV is | | | |
| | Change TV Assgn | [Root Menu] → Process variables → Output vars → TV → | | |
| | TV | | | |
| | TV is | | | |
| | Change 4V Assgn or Change QV Assgn | [Root Menu] → Process variables → Output vars → 4V/QV → | | |
| | 4V/QV | | | |
| | 4V is/QV is | | | |
| | PV Limit Status HART 7 | [Root Menu] → Process variables → Output vars → PV → | | |
| | PV Data Quality HART 7 | | | |
| | SV Limit Status HART 7 | [Root Menu] → Process variables → Output vars → SV → | | |
| | SV Data Quality HART 7 | | | |
| | TV Limit Status HART 7 | [Root Menu] → Process variables → Output vars → TV → | | |
| | TV Data Quality HART 7 | | | |
| | QV Limit Status HART 7 | [Root Menu] → Process variables → Output vars → QV → | | |
| | QV Data Quality HART 7 | | | |
| | % Range HART 7 | [Root Menu] → Process variables → Device variables and Status → | | |
| | % Range Limit Status HART 7 | | | |
| | % Range Data Quality HART 7 | | | |
| | Loop Current HART 7 | | | |
| | Loop Current Limit Status HART 7 | | | |
| | Loop Current Data Quality HART 7 | | | |
| | | | | |
| Device Variable Simulation | Simulate HART 7 | [Root Menu] → Diag/Service → Test → | | |

| Function | Label | DD (HART 7) EJX910 HART 7 DTM (HART 7) EJX910 FDT2.0 HART 7 DTM (HART 7) | DD (HART 5) EJX910 HART DTM (HART 5) EJX910 FDT2.0 HART DTM (HART 5) | EJX910 V2.1 DTM (HART 5) | | | |
|----------------------------|--|---|---|---|--|-----|---|
| Advanced diagnostic (ILBD) | Diag Applicable | [Root Menu] → Diag/Service → Diag Parameters → ILBD parameters → | | Diag and Service → Advanced Diag Alerts → Diag Error → | | | |
| | Diag DPComp | [Root Menu] → Diag/Service → Diag Parameters → ILBD parameters → Configuration → Configuration | | Diag and Service → Advanced Diag Configurations → Impulse Line Blockage Detection → | | | |
| | Diag Error | [Root Menu] → Diag/Service → Diag Parameters → | | Diag and Service → Advanced Diag Alerts → | | | |
| | Lim fDPmax | [Root Menu] → Diag/Service → Diag Parameters → ILBD parameters → Configuration → Diag Lim → | | Diag and Service → Advanced Diag Configurations → Impulse Line Blockage Detection → Threshold → Sensitivity → | | | |
| | Lim fDPmin | | | | | | |
| | Lim fSPImax | | | | | | |
| | Lim fSPImin | | | | | | |
| | Lim fSPHmax | | | | | | |
| | Lim fSPHmin | | | | | | |
| | Lim BlkFmax | | | | | | |
| | Lim BlkFmin | | | | | | |
| | Lim DPAvgmax | | | | | | |
| | Lim DPAvgmin | | | | | | |
| | Diag Mode | | | | [Root Menu] → Diag/Service → Diag Parameters → ILBD Parameters → | | Diag and Service → Advanced Diag Configurations → Impulse Line Blockage Detection → |
| | Set Diag Mode | | | | [Root Menu] → Diag/Service → Diag Parameters → ILBD Parameters → Configuration → Configuration → | | --- |
| | Diag Option | [Root Menu] → Diag/Service → Diag Parameters → | | Diag and Service → Advanced Diag Configurations → Impulse Line Blockage Detection → Alarm Notification → | | | |
| | Diag Out Option | [Root Menu] → Diag/Service → Diag Parameters → Diag Output → | | Diag and Service → Advanced Diag Configurations → Diag Output | | | |
| | Diag Fixed Out Val | | | | | | |
| | Diag Period | [Root Menu] → Diag/Service → Diag Parameters → ILBD Parameters → Configuration → Configuration → | | Diag and Service → Advanced Diag Configurations → Impulse Line Blockage Detection → | | | |
| | Diag Description | [Root Menu] → Diag/Service → Diag Parameters → ILBD Parameters → Configuration → Diag Reference → | | Diag and Service → Advanced Diag Configurations → Impulse Line Blockage Detection → | | | |
| | fDP | [Root Menu] → Diag/Service → Diag Parameters → ILBD parameters → Status → Fluct Variables → | | Diag and Service → Advanced Diag Variables → | | | |
| | fDP Status | | | | | | |
| | fSPI | | | | | | |
| | fSPI Status | | | | | | |
| | fSPH | | | | | | |
| fSPH Status | | | | | | | |
| Ref fDP | [Root Menu] → Diag/Service → Diag Parameters → ILBD parameters → Status → Diag Reference → | | Diag and Service → Advanced Diag Configurations → Impulse Line Blockage Detection → | | | | |
| Ref fDP Status | | | | | | | |
| Ref fSPI | | | | | | | |
| Ref fSPI Status | | | | | | | |
| Ref fSPH | | | | | | | |
| Ref fSPH Status | | | | | | | |
| Ref BlkF | | | | | | | |
| Ref BlkF Status | | | | | | | |
| Ref DPAvg | | | | | | | |
| Ref DPAvg Status | | | | | | | |
| Ref Lim fDPmin | | | | [Root Menu] → Diag/Service → Diag Parameters → ILBD Parameters → Configuration → Diag Ref Lim → | | --- | |
| Ref Lim fSPmin | | | | | | | |
| Ref Lim BlkFmax | | | | | | | |

| Function | Label | DD (HART 7) EJX910 HART 7 DTM (HART 7) EJX910 FDT2.0 HART 7 DTM (HART 7) | DD (HART 5) EJX910 HART DTM (HART 5) EJX910 FDT2.0 HART DTM (HART 5) | EJX910 V2.1 DTM (HART 5) |
|---|--|--|---|---|
| (Advanced diagnostic (ILBD)) | Diag Supp Count or Diag Suppress Count | [Root Menu] → Diag/Service → Diag Parameters → ILBD Parameters → Configuration → Configuration → | | Diag and Service → Advanced Diag Configurations → Impulse Line Blockage Detection → Threshold → |
| | Ratio fDP | [Root Menu] → Diag/Service → Diag Parameters → ILBD parameters → Status → Diag Variables → | | Diag and Service → Advanced Diag Variables → |
| | Ratio fDP Status | | | |
| | Ratio fSPI | | | |
| | Ratio fSPI Status | | | |
| | Ratio fSPh | | | |
| | Ratio fSPh Status | | | |
| | BIkF | | | |
| | BIkF Status | | | |
| | DPAvg | | | |
| | DPAvg Status | | | |
| | CRatio fDP | | | |
| | CRatio fDP Status | | | |
| | NRatio fDP | | | |
| NRatio fDP Status | | | | |
| Advanced diagnostic (Heat Trace Monitoring) | Flg temp Coef or Flg Temp Coefficient | [Root Menu] → Diag/Service → Diag Parameters → HT Parameters → Configuration → | | Diag and Service → Advanced Diag Configurations → |
| | Flg temp Hi Alarm Val or Flg Temp High Limit | | | Diag and Service → Advanced Diag Configurations → |
| | Flg temp Lo Alarm Val or Flg Temp Low Limit | | | |
| | Flg temp | [Root Menu] → Diag/Service → Diag Parameters → HT Parameters → Status → | | Diag and Service → Advanced Diag Variables → |
| Optional function | Option Password | [Root Menu] → Detailed setup → Device information → Additional info → | [Root Menu] → Detailed setup → Device information → Field device info → Field device info → | Configuration → Device Information2 → |

| Function | Label | DD (HART 7) EJX910 HART 7 DTM (HART 7) EJX910 FDT2.0 HART 7 DTM (HART 7) | DD (HART 5) EJX910 HART DTM (HART 5) EJX910 FDT2.0 HART DTM (HART 5) | EJX910 V2.1 DTM (HART 5) | | | |
|--|--|---|---|--------------------------|---|-----|--|
| User Flow Parameters (Setting information for Auto Compensation Mode) (Available only when the device revision is 12 or later) | PD Type & Desc | [Root Menu] → Detailed setup → Flow Config information → Primary device (PD) → | --- | | | | |
| | PD Desc (User Defined) | | | | | | |
| | PD Model Type | | | | | | |
| | Discharge/Flow Coef Option | | | | | | |
| | Discharge/Flow Coef Constant | | | | | | |
| | Gas Exp Factor Option | | | | | | |
| | Gas Exp Factor Constant 1 | | | | | | |
| | PD Diameter (d) | | | | | | |
| | PD Diameter Unit | | | | | | |
| | PD Temperature | | | | | | |
| | PD Temperature Unit | | | | | | |
| | PD Material | | | | | | |
| | PD Material Thermal Exp Factor | | | | | | |
| | Pipe Diameter (D) | | | | [Root Menu] → Detailed setup → Flow Config information → Pipe → | --- | |
| | Pipe Diameter Unit | | | | | | |
| Pipe Temperature | | | | | | | |
| Pipe Temperature Unit | | | | | | | |
| Pipe Material | | | | | | | |
| Pipe Material Thermal Exp Factor | | | | | | | |
| Num of Points | [Root Menu] → Detailed setup → Flow Config information → Discharge/Flow Coef → | --- | | | | | |
| Reynolds Num #1 ~ #20 | | | | | | | |
| Discharge/Flow Coef #1 ~ #20 | | | | | | | |
| Gas Exp Factor Constant 1 | [Root Menu] → Detailed setup → Flow Config information → Gas Exp Factor → | --- | | | | | |
| Gas Exp Factor Constant 2 | | | | | | | |
| Fluid Type | [Root Menu] → Detailed setup → Flow Config information → Fluid Type → | --- | | | | | |
| Fluid Category | | | | | | | |
| Fluid Name/Method | | | | | | | |
| Fluid Name/Method (custom) | | | | | | | |

| Function | Label | DD (HART 7) EJX910 HART 7 DTM (HART 7) EJX910 FDT2.0 HART 7 DTM (HART 7) | DD (HART 5) EJX910 HART DTM (HART 5) EJX910 FDT2.0 HART DTM (HART 5) | EJX910 V2.1 DTM (HART 5) |
|--|-----------------------------------|---|---|--------------------------|
| (User Flow Parameters) (Setting information for Auto Compensation Mode) (Available only when the device revision is 12 or later) | CH4 Methane Mole | [Root Menu] → Detailed setup → Flow Config information → Natural Gas → Detail/Molar composition → | --- | |
| | N2 Nitrogen Mole | | | |
| | CO2 Carbon Dioxide Mole | | | |
| | C2H6 Ethane Mole | | | |
| | C3H8 Propane Mole | | | |
| | H2O Water Mole | | | |
| | H2S Hydrogen Sulfide Mole | | | |
| | H2 Hydrogen Mole | | | |
| | CO Carbon Monoxide Mole | | | |
| | O2 Oxygen Mole | | | |
| | C4H10 i-Butane Mole | | | |
| | C4H10 n-Butane Mole | | | |
| | C5H12 i-Pentane Mole | | | |
| | C5H12 n-Pentane Mole | | | |
| | C6H14 n-Hexane Mole | | | |
| | C7H16 n-Heptane Mole | | | |
| | C8H18 n-Octane Mole | | | |
| | C9H20 n-Nonane Mole | | | |
| | C10H22 n-Decane Mole | | | |
| | He Helium Mole | | | |
| Ar Argon Mole | | | | |
| Real Gas Relative Density | Real Gas Relative Density | [Root Menu] → Detailed setup → Flow Config information → Natural Gas → Gross/Physical property → | --- | |
| | Volumetric Gross Heating Value | | | |
| | Volumetric Gross Heating Val Unit | | | |
| | Carbon Dioxide (CO2) Mole | | | |
| | Nitrogen (N2) Mole | | | |
| | Hydrogen (H2) Mole | | | |
| | Carbon Monoxide (CO) Mole | | | |
| Operating SP Lower Value | Operating SP Lower Value | [Root Menu] → Detailed setup → Flow Config information → Fluid Operating Range → | --- | |
| | Operating SP Upper Value | | | |
| | Operating SP Unit | | | |
| | Atmospheric Pressure | | | |
| | Atmospheric Pressure Unit | | | |
| | Operating Temp Lower Range | | | |
| | Operating Temp Upper Range | | | |
| | Operating Temp Unit | | | |
| | Ref Condition Pressure | | | |
| | Ref Condition Pres Unit | | | |
| | Ref Condition Temperature | | | |
| | Ref Condition Temp Unit | | | |

| Function | Label | DD (HART 7) EJX910 HART 7 DTM (HART 7) EJX910 FDT2.0 HART 7 DTM (HART 7) | DD (HART 5) EJX910 HART DTM (HART 5) EJX910 FDT2.0 HART DTM (HART 5) | EJX910 V2.1 DTM (HART 5) |
|--|---|--|---|--------------------------|
| (User Flow Parameters) (Setting information for Auto Compensation Mode) (Available only when the device revision is 12 or later) | Density Unit Density Table 1 ~ 12 Viscosity Unit Viscosity Table 1 ~ 4 Molecular Weight Isentropic Exponent Reference Density | [Root Menu] → Detailed setup → Flow Config information → Fluid Physical Property → | --- | |
| Service Information (Available only when the device revision is 12 or later) | Info 01 ~ Info 65 | [Root Menu] → Detailed setup → Devuce information → Service information | --- | |

Appendix 1. Safety Instrumented Systems Installation



WARNING

When using the EJX for Safety Instrumented Systems (SIS) application, the instructions and procedures in this section must be strictly followed in order to preserve the transmitter for that safety level.

A1.1 Scope and Purpose

This section provides an overview of the user responsibilities for installation and operation of the EJX in order to maintain the designed safety level for Safety Instrumented Systems (SIS) applications. Items that will be addressed are proof testing, repair and replacement of the transmitter, reliability data, lifetime, environmental and application limits, and parameter settings.

A1.2 Using the EJX for an SIS Application

A1.2.1 Safety Accuracy

The EJX has a specified safety accuracy of 2%. This means that the internal component failures are listed in the device failure rate if they will cause an error of 2% or greater.

A1.2.2 Diagnostic Response Time

The EJX will report an internal failure within 5 seconds of the fault occurrence.

A1.2.3 Setup

During installation the transmitter must be setup with engineering units parameters. This is typically done with a handheld terminal. These parameters must be verified during the installation to insure that the correct parameters are in the transmitter. Engineering range parameters can be verified by reading these parameters from the optional local display or by checking actual calibration of the transmitter.

When measuring the flow, please verify that the flow configuration was done correctly by flow simulation.

For details on range and unit settings, refer to the section of Measuring Range in chapter of Parameter Setting in the EJX910A / EJX930A instruction manual shown in the table below. See also the section of Setting status output.

For information on flow configuration setup and flow simulation, refer to the FSA120 instruction manual shown in the table below.

| FieldMate Versatile Device Management Wizard | | | | Flow Configuration Software | Multivariable Transmitter | |
|---|-------------------------|---|---|--|--|--------------------|
| FSA111 | | | | FSA120 | EJX910A/EJX930A | |
| FieldMate Revision | DeviceFiles Revision | DTM Library Revision | Device DTM Revision | FlowNavigator DTM Library / Resource Revision | Software Revision | Device Revision |
| R3.03 or later | R3.08.10 or later | YOKOGAWA Device DTM Library 7.2 or later | EJX910 FDT2.0 HART 7 DTM 5.7.2.0 or later | R2.02.00 or later | 4.01 4.02 | 11 |
| IM 01R01A01-01E 15th edition or later | | | | IM 01C25R51-01E 11th edition or later | IM 01C25R02-01E* 8th edition or later | |
| R3.04.20 or later | R3.09.23 or later | YOKOGAWA Device DTM Library 8.9 or later | EJX910 FDT2.0 HART 7 DTM 5.9.9.0 or later | R2.03.00 or later | 5.01 | 12 |
| IM 01R01A01-01E 20th edition or later | | | | IM 01C25R51-01E 12th edition or later | IM 01C25R02-01E* 9th edition or later | |

*: This document includes both User's Manual and Safety Manual.

If a user makes mistakes or the setting error is detected during the following parameter settings, the user cannot use instruments safely.

- Engineering units parameters
 - Engineering range parameters
 - Flow Parameters(the parametes configured in the flow cofiguration tool)
 - External Temperature Fixation Mode (“ET Fixed” parameter)
- External temperature configuration and value is limited when calculating flow value of saturated steam (Following IAPWS-IF97).
- 1: Output external temperature measured by RTD sensor:
 Configuration: ET Fixed = No
 External temperature value limit: 0 to 374 °C
 (Under saturated steam state)
 External temperature range: -210 to 860 °C
- 2: Output external temperature calculated from the static pressure by using the built-in steam table:
 Configuration: ET Fixed = Saturated Steam
 External temperature value limit: 90 to 374 °C
 External temperature range: 100 to 349 °C

Please try setting parameters again until all the parameters are set correctly.

Example of error message dialog box

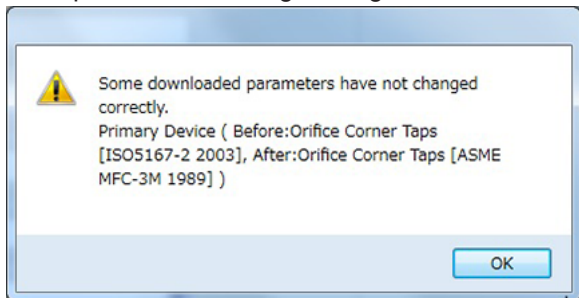

The calibration of the transmitter must be performed after parameters are set.

A1.2.4 Required Parameter Settings

The following parameters need to be set in order to maintain the designed safety integrity.

Table A1.1 Required Parameter Settings

| Item | Description |
|--------------------------|--|
| Burnout direction switch | To specify if the output should go 21.6 mA or higher or 3.6 mA or lower upon detection of an internal failure. |
| Write protection switch | The write function should be disabled. |

A1.2.5 Proof Testing

The objective of proof testing is to detect failures within the transmitter that are not detected by the diagnostics of the transmitter. Of main concern are undetected failures that prevent the safety instrumented function from performing its intended function. See table A1.2 for proof testing method.

The frequency of the proof tests (or the proof test interval) is to be determined in the reliability calculations for the safety instrumented functions for which the EJX is applied. The actual proof tests must be performed more frequently or as frequently as specified in the calculation in order to maintain required safety integrity of the safety instrumented function.

The following tests need to be specifically executed when a proof test is performed. The results of the proof test need to be documented and this documentation should be part of a plant safety management system. Failures that are detected should be reported to Yokogawa.

The personnel performing the proof test of the transmitter should be trained in SIS operations including bypass procedures, EJX transmitter maintenance, and company management of change procedures.

Table A1.2 Proof Testing

| Testing method | Tools required | Expected outcome | Remarks |
|---|---|--------------------------|--|
| Functional test: 1. Follow all Management of Change procedures to bypass logic solvers if necessary. 2. Execute HART/BRAIN command to send value to high alarm (21.6 mA) and verify that current has reached this level. 3. Execute HART/BRAIN command to send value to low alarm (3.8 mA) and verify that current has reached this level. 4. Restore logic solvers operation and verify. | <ul style="list-style-type: none"> • Handheld terminal | Proof Test Coverage =52% | The output needs to be monitored to assure that the transmitter communicates the correct signal. |
| Perform three point calibration along with the functional test listed above. | <ul style="list-style-type: none"> • Handheld terminal • Calibrated pressure source | Proof Test Coverage =99% | |

A1.2.6 Repair and Replacement

If repair is to be performed with the process online the EJX will need to be bypassed during the repair. The user should setup appropriate bypass procedures.

In the unlikely event that the EJX has a failure, the failures that are detected should be reported to Yokogawa.

When replacing the EJX, the procedure in the installation manual should be followed.

The personnel performing the repair or replacement of the EJX should have a sufficient skill level.

A1.2.7 Startup Time

The EJX generates a valid signal within 1 second of power-on startup.

A1.2.8 Firmware Update

In case firmware updates are required, they will be performed at factory. The replacement responsibilities are then in place. The user will not be required to perform any firmware updates.

A1.2.9 Reliability Data

For failure rates and failure modes, Refer to Table 2.1 Functional safety data in the Functional Safety Manual (document no: TI 01C25A05-01EN).

The Functional Safety Manual can be downloaded from our website by entering the document number.

Website Address

<https://www.yokogawa.com/library/>

The EJX is certified up to SIL2 for use in a simplex (1oo1) configuration, depending on the PFDavg calculation of the entire Safety Instrumented Function.

The development process of the EJX is certified up to SIL3, allowing redundant use of the transmitter up to this Safety Integrity Level, depending the PFDavg calculation of the entire Safety Instrumented Function.

When using the transmitter in a redundant configuration, the use of a common cause factor (β-factor) of 2% is suggested. (However, if the redundant transmitters share an impulse line or if clogging of the separate impulse lines is likely, a common cause factor of 10% is suggested.)

Note that the failure rates of the impulse lines need to be accounted for in the PFDavg calculation.

A1.2.10 Lifetime Limits

The expected lifetime of the EJX is 50 years. The reliability data listed in the FMEDA report is only valid for this period. The failure rates of the EJX may increase sometime after this period. Reliability calculations based on the data listed in the FMEDA report for EJX lifetimes beyond 50 years may yield results that are too optimistic, i.e. the calculated Safety Integrity Level will not be achieved.

Verification

The demonstration for each phase of the life-cycle that the (output) deliverables of the phase meet the objectives and requirements specified by the inputs to the phase. The verification is usually executed by analysis and/or testing

Validation

The demonstration that the safety-related system(s) or the combination of safety-related system(s) and external risk reduction facilities meet, in all respects, the Safety Requirements Specification. The validation is usually executed by testing

A1.2.11 Environmental Limits

The environmental limits of the EJX are specified in the user's manual IM 01C25.

A1.2.12 Application Limits

The application limits of the EJX are specified in the user's manual IM 01C25. If the transmitter is used outside of the application limits, the reliability data listed in A1.2.9 becomes invalid.

Safety Assessment

The investigation to arrive at a judgment -based on evidence- of the safety achieved by safety-related systems

Further definitions of terms used for safety techniques and measures and the description of safety related systems are given in IEC 61508-4.

A1.3 Definitions and Abbreviations

A1.3.1 Definitions

| | |
|-------------------|---|
| Safety | Freedom from unacceptable risk of harm |
| Functional Safety | The ability of a system to carry out the actions necessary to achieve or to maintain a defined safe state for the equipment/machinery/plant/ apparatus under control of the system |
| Basic Safety | The equipment must be designed and manufactured such that it protects against risk of damage to persons by electrical shock and other hazards and against resulting fire and explosion. The protection must be effective under all conditions of the nominal operation and under single fault condition |

A1.3.2 Abbreviations

| | |
|-------|---|
| FMEDA | Failure Mode, Effects and Diagnostic Analysis |
| SIF | Safety Instrumented Function |
| SIL | Safety Integrity Level |
| SIS | Safety Instrumented System |
| SLC | Safety Lifecycle |

Appendix 2. ILBD Check List

Fill out the below checklist according to the operation flow of the ILBD in order to keep the important information for the blockage detection.

Checklist (1/5)

| No. | Items | Parameters | Result | Example |
|-------------------------------|--|--------------------------|-------------------------------------|-------------------------------------|
| 1 | 4-20 mA Analog Signal Setting <ul style="list-style-type: none"> Select the output mode when an alarm is generated. | Diag Out Option | Off: <input type="checkbox"/> | <input checked="" type="checkbox"/> |
| | | | Burnout: <input type="checkbox"/> | <input type="checkbox"/> |
| | | Diag Fixed Out Val | Fall back: <input type="checkbox"/> | <input type="checkbox"/> |
| | | | mA | 21.6 mA |
| 2 | Status Output | DO Select | Pres: <input type="checkbox"/> | <input type="checkbox"/> |
| | | | SP: <input type="checkbox"/> | <input type="checkbox"/> |
| | | | Temp: <input type="checkbox"/> | <input type="checkbox"/> |
| | | | Flow: <input type="checkbox"/> | <input type="checkbox"/> |
| | | | Diag: <input type="checkbox"/> | <input checked="" type="checkbox"/> |
| All: <input type="checkbox"/> | <input type="checkbox"/> | | | |
| 3 | Stability of Pres (differential pressure/pressure) under normal condition <ul style="list-style-type: none"> Check that the status of Pres is "GOOD". Check the maximum and minimum values of Pres. | Status | | Good |
| | | Pres | Max.: Min.: | Max.: 12.3 kPa Min.: 12.1 kPa |
| 4 | fDP under normal condition <ul style="list-style-type: none"> Check that the value of fDP is more than 7×10^{-10}. | fDP | <input type="checkbox"/> | <input checked="" type="checkbox"/> |
| 5 | Start to obtain Reference values <ul style="list-style-type: none"> Set "Reference" to Diag Mode. | Diag Mode | <input type="checkbox"/> | <input checked="" type="checkbox"/> |
| 6 | End of Reference Value Sampling <ul style="list-style-type: none"> Check that Diag Mode is "Calculation" after the time set to "Diag Period" passed. | Diag Mode | <input type="checkbox"/> | <input checked="" type="checkbox"/> |
| 7 | Alarm setting <ul style="list-style-type: none"> Record the status of Checkbox in Diag Option. | Diag Option | | |
| | | A Blocking | <input type="checkbox"/> | <input checked="" type="checkbox"/> |
| | | Large Fluct L | <input type="checkbox"/> | <input checked="" type="checkbox"/> |
| | | Large Fluct H | <input type="checkbox"/> | <input checked="" type="checkbox"/> |
| | | L Side Blocking | <input type="checkbox"/> | <input checked="" type="checkbox"/> |
| | | H Side Blocking | <input type="checkbox"/> | <input checked="" type="checkbox"/> |
| | | B Blocking | <input type="checkbox"/> | <input checked="" type="checkbox"/> |
| | | Invalid Ref F | <input type="checkbox"/> | <input checked="" type="checkbox"/> |
| | | Invalid Ref SPH | <input type="checkbox"/> | <input type="checkbox"/> |
| | | Invalid Ref SPL | <input type="checkbox"/> | <input type="checkbox"/> |
| | | Invalid Ref DP | <input type="checkbox"/> | <input checked="" type="checkbox"/> |
| ILBD over range | <input type="checkbox"/> | <input type="checkbox"/> | | |

Checklist (2/5)

| No. | Items | Parameters | Result | Example |
|-----------------|--|--------------------------|--------------------------|-------------------------------------|
| 8 | Alarm status • Check the alarm status shown in Diag Error . • Check that the alarm status of “ILBD over range” is not shown in Diag Error . | Diag Error | | |
| | | A Blocking | <input type="checkbox"/> | <input type="checkbox"/> |
| | | Large Fluct L | <input type="checkbox"/> | <input type="checkbox"/> |
| | | Large Fluct H | <input type="checkbox"/> | <input type="checkbox"/> |
| | | L Side Blocking | <input type="checkbox"/> | <input type="checkbox"/> |
| | | H Side Blocking | <input type="checkbox"/> | <input type="checkbox"/> |
| | | B Blocking | <input type="checkbox"/> | <input type="checkbox"/> |
| | | Invalid Ref F | <input type="checkbox"/> | <input checked="" type="checkbox"/> |
| | | Invalid Ref SPH | <input type="checkbox"/> | <input type="checkbox"/> |
| | | Invalid Ref SPL | <input type="checkbox"/> | <input type="checkbox"/> |
| | | Invalid Ref DP | <input type="checkbox"/> | <input type="checkbox"/> |
| ILBD over range | <input type="checkbox"/> | <input type="checkbox"/> | | |
| 9 | ILBD parameters • Record the values of parameters for ILBD operation. • Check the status of parameters for ILBD operation. *: Record the value after checked that the status of each parameter is “GOOD”. | Diag Period | | 180 |
| | | Lim fDPmax | | 3.000000 |
| | | Lim fDPmin | | 0.300000 |
| | | Lim fSPImax | | 5.000000 |
| | | Lim fSPimin | | 0.500000 |
| | | Lim fSPHmax | | 5.000000 |
| | | Lim fSPHmin | | 0.500000 |
| | | Lim BlkFmax | | 0.600000 |
| | | Lim BlkFmin | | -0.600000 |
| | | Lim DPAvgmax | | 1.000000 |
| | | Lim DPAvgmin | | 0.050000 |
| | | Diag Supp Count | | 3 |
| | | Ref fDP* | | 7.43245E-09 |
| | | Ref fSPI* | | 7.25765E-09 |
| | | Ref fSPH* | | 7.18374E-09 |
| | | Ref DPAvg* | | 5.36425E+00 |
| | | fDP* | | 7.48562E-09 |
| | | fSPI* | | 7.23277E-09 |
| | | fSPH* | | 7.14085E-09 |
| | | BlkF* | | -0.287259 |
| DPAvg* | | 0.055957 | | |

Checklist (3/5)

Go to the following step according to the result of "Invalid Ref xx" shown in the **Diag Error** of 8th check item.

| Diag Error | | | → | Check item |
|-------------------------------------|-------------------------------------|--------------------------|---|------------|
| Invalid Ref SPH | Invalid Ref SPL | Invalid Ref DP | | |
| <input type="checkbox"/> | <input type="checkbox"/> | <input type="checkbox"/> | → | 10-a |
| <input checked="" type="checkbox"/> | <input checked="" type="checkbox"/> | <input type="checkbox"/> | → | 10-b |

- : The alarm is generated.
- : The alarm is not generated.

| No. | Items | Parameters | Result | Example |
|--|--|--------------------------|-------------------------------------|-------------------------------------|
| 10-a | Simulation of Blockage detection operation <ul style="list-style-type: none"> • H Side Blocking: 10-a-1 • L Side Blocking: 10-a-2 • Both Side Blocking: 10-a-3 | | | |
| 10-a-1 | H Side Blocking <ul style="list-style-type: none"> • Close the high-pressure side valve completely. • Record the values of fDP, fSPI, fSPH, BlkF, and DPAvg after the certain time, (Diag Period X Diag Supp Count), passed. *: Record the value after checked that the status is "GOOD". | fDP* | | 7.48562E-09 |
| | | fSPI* | | 7.23277E-09 |
| | | fSPH* | | 7.14085E-09 |
| | | BlkF | | -0.287259 |
| | <ul style="list-style-type: none"> • Record the status of Checkbox in Diag Option. • Check that the alarms status of "A Blocking" and "H Side Blocking" are set. Note: If the alarm of "ILBD over range" is generated, the valve may be closed too much tightly. Open valve a little and record the updated status of the parameters. | Diag Option | | |
| | | A Blocking | <input type="checkbox"/> | <input checked="" type="checkbox"/> |
| | | Large Fluct L | <input type="checkbox"/> | <input type="checkbox"/> |
| | | Large Fluct H | <input type="checkbox"/> | <input type="checkbox"/> |
| | | L Side Blocking | <input type="checkbox"/> | <input type="checkbox"/> |
| | | H Side Blocking | <input type="checkbox"/> | <input checked="" type="checkbox"/> |
| | | B Blocking | <input type="checkbox"/> | <input type="checkbox"/> |
| | | Invalid Ref F | <input type="checkbox"/> | <input type="checkbox"/> |
| | | Invalid Ref SPH | <input type="checkbox"/> | <input type="checkbox"/> |
| | Invalid Ref SPL | <input type="checkbox"/> | <input type="checkbox"/> | |
| Invalid Ref DP | <input type="checkbox"/> | <input type="checkbox"/> | | |
| ILBD over range | <input type="checkbox"/> | <input type="checkbox"/> | | |
| <ul style="list-style-type: none"> • Check that the alarm of "H Side Blocking" is generated. • Check that the alarm of "L Side Blocking" is not generated. | Diag Error | | | |
| | L Side Blocking | <input type="checkbox"/> | <input type="checkbox"/> | |
| | H Side Blocking | <input type="checkbox"/> | <input checked="" type="checkbox"/> | |

Checklist (4/5)

| No. | Items | Parameters | Result | Example |
|--------|--|--------------------------|--------------------------|-------------------------------------|
| 10-a-2 | L Side Blocking | | | |
| | <ul style="list-style-type: none"> Close the low-pressure side valve completely. | | | |
| | <ul style="list-style-type: none"> Record the values of fDP, fSPI, fSPH, BlkF, and DPAvg after the certain time, (Diag Period X Diag Supp Count), passed. | fDP* | | 7.48562E-09 |
| | | fSPI* | | 7.23277E-09 |
| | | fSPH* | | 7.14085E-09 |
| | | BlkF | | -0.287259 |
| | <ul style="list-style-type: none"> Record the status of Checkbox in Diag Option. Check that the alarms status of "A Blocking" and "L Side Blocking" are set. | Diag Option | | |
| | | A Blocking | <input type="checkbox"/> | <input checked="" type="checkbox"/> |
| | | Large Fluct L | <input type="checkbox"/> | <input type="checkbox"/> |
| | | Large Fluct H | <input type="checkbox"/> | <input type="checkbox"/> |
| | | L Side Blocking | <input type="checkbox"/> | <input checked="" type="checkbox"/> |
| | | H Side Blocking | <input type="checkbox"/> | <input type="checkbox"/> |
| | | B Blocking | <input type="checkbox"/> | <input type="checkbox"/> |
| | | Invalid Ref F | <input type="checkbox"/> | <input type="checkbox"/> |
| | | Invalid Ref SPH | <input type="checkbox"/> | <input type="checkbox"/> |
| | | Invalid Ref SPL | <input type="checkbox"/> | <input type="checkbox"/> |
| | | Invalid Ref DP | <input type="checkbox"/> | <input type="checkbox"/> |
| | ILBD over range | <input type="checkbox"/> | <input type="checkbox"/> | |
| | | Diag Error | | |
| | | L Side Blocking | <input type="checkbox"/> | <input checked="" type="checkbox"/> |
| | | H Side Blocking | <input type="checkbox"/> | <input type="checkbox"/> |
| 10-a-3 | Both Side Blocking | | | |
| | <ul style="list-style-type: none"> Close the both-pressure side valves completely. | | | |
| | <ul style="list-style-type: none"> Record the values of fDP, fSPI, fSPH, BlkF, and DPAvg after the certain time, (Diag Period X Diag Supp Count), passed. | fDP* | | 7.48562E-09 |
| | | fSPI* | | 7.23277E-09 |
| | | fSPH* | | 7.14085E-09 |
| | | BlkF | | -0.287259 |
| | <ul style="list-style-type: none"> Record the status of Checkbox in Diag Option. Check that the alarms status of "H Side Blocking", "L Side Blocking", and "B Blocking" are set. | Diag Option | | |
| | | A Blocking | <input type="checkbox"/> | <input type="checkbox"/> |
| | | Large Fluct L | <input type="checkbox"/> | <input type="checkbox"/> |
| | | Large Fluct H | <input type="checkbox"/> | <input type="checkbox"/> |
| | | L Side Blocking | <input type="checkbox"/> | <input checked="" type="checkbox"/> |
| | | H Side Blocking | <input type="checkbox"/> | <input checked="" type="checkbox"/> |
| | | B Blocking | <input type="checkbox"/> | <input checked="" type="checkbox"/> |
| | | Invalid Ref F | <input type="checkbox"/> | <input type="checkbox"/> |
| | | Invalid Ref SPH | <input type="checkbox"/> | <input type="checkbox"/> |
| | | Invalid Ref SPL | <input type="checkbox"/> | <input type="checkbox"/> |
| | | Invalid Ref DP | <input type="checkbox"/> | <input type="checkbox"/> |
| | ILBD over range | <input type="checkbox"/> | <input type="checkbox"/> | |
| | | Diag Error | | |
| | | B Blocking | <input type="checkbox"/> | <input checked="" type="checkbox"/> |

Checklist (5/5)

| No. | Items | Parameters | Result | Example |
|--|--|--------------------------|-------------------------------------|--------------------------|
| 10-b | Simulation of Blockage detection operation | | | |
| | <ul style="list-style-type: none"> Close completely the valve for the side where the alarm of Invalid Reference Value is not generated. | | | |
| | For the case that the high-pressure side value is closed; | fDP* | | 7.48562E-09 |
| | <ul style="list-style-type: none"> Record the values of fDP, fSPI, fSPH, BlkF, and DPAvg after the certain time, (Diag Period X Diag Supp Count), passed. | | | |
| | *: Record the value after checked that the status is "GOOD". | fSPH* | | 7.14085E-09 |
| | For the case that the low-pressure side value is closed; | fDP* | | 7.48562E-09 |
| | <ul style="list-style-type: none"> Record the values of fDP, fSPI, fSPH, BlkF, and DPAvg after the certain time, (Diag Period X Diag Supp Count), passed. | | | |
| | *: Record the value after checked that the status is "GOOD". | fSPI* | | 7.23277E-09 |
| | <ul style="list-style-type: none"> Record the status of Checkbox in Diag Option. Check that the alarms status of "B Blocking" is set. | Diag Option | | |
| | Note: If the alarm of "ILBD over range" is generated, the valve may be closed too much tightly. Open valve a little and record the updated status of the parameters. | A Blocking | <input type="checkbox"/> | <input type="checkbox"/> |
| | | Large Fluct L | <input type="checkbox"/> | <input type="checkbox"/> |
| | | Large Fluct H | <input type="checkbox"/> | <input type="checkbox"/> |
| | | L Side Blocking | <input type="checkbox"/> | <input type="checkbox"/> |
| H Side Blocking | | <input type="checkbox"/> | <input type="checkbox"/> | |
| B Blocking | | <input type="checkbox"/> | <input checked="" type="checkbox"/> | |
| Invalid Ref F | | <input type="checkbox"/> | <input checked="" type="checkbox"/> | |
| Invalid Ref SPH | | <input type="checkbox"/> | <input type="checkbox"/> | |
| Invalid Ref SPL | | <input type="checkbox"/> | <input checked="" type="checkbox"/> | |
| Invalid Ref DP | <input type="checkbox"/> | <input type="checkbox"/> | | |
| ILBD over range | <input type="checkbox"/> | <input type="checkbox"/> | | |
| <ul style="list-style-type: none"> Check that the alarm of "B Blocking" is not generated. | Diag Error | | | |
| | B Blocking | <input type="checkbox"/> | <input checked="" type="checkbox"/> | |

Appendix 3. Menu Tree for Previous Version

This chapter is a Menu Tree for earlier versions for DD and DTM.

For Device revision 10 and earlier, see Appendix 3.1.

For Device revision 11, see Appendix 3.2.

Refer to chapter 3 for the information of the latest version.

A3.1 Menu Tree (Device revision 10 or earlier)

The menu tree is different in DD (HART 5/HART 7)/DTM (HART 7) and DTM (HART 5).

See the menu tree corresponding to the configuration tool.

A3.1.1 For DD (HART 5/HART 7) and DTM (HART 7)

■ DD (HART 5/HART 7 Dev.Rev.10)

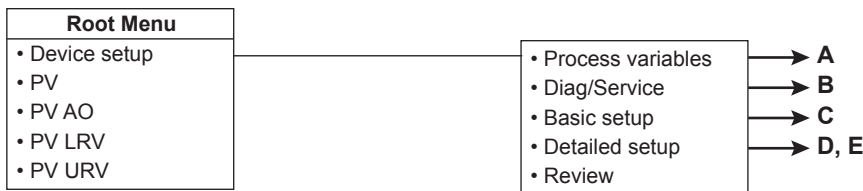

■ EJX910 HART 7 DTM (Dev.Rev.10)

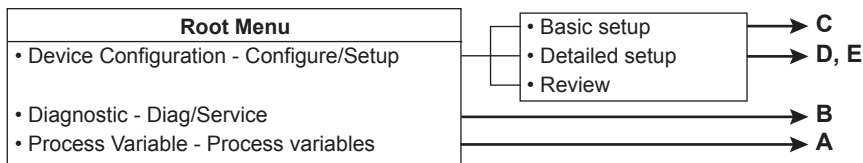

■ EJX910 HART DTM

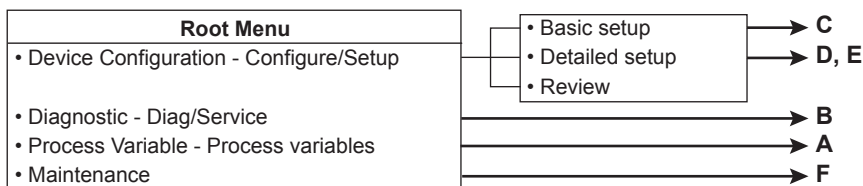

FA0301-01.ai

A

HART 5 : HART 5 only

HART 7 : HART 7 only

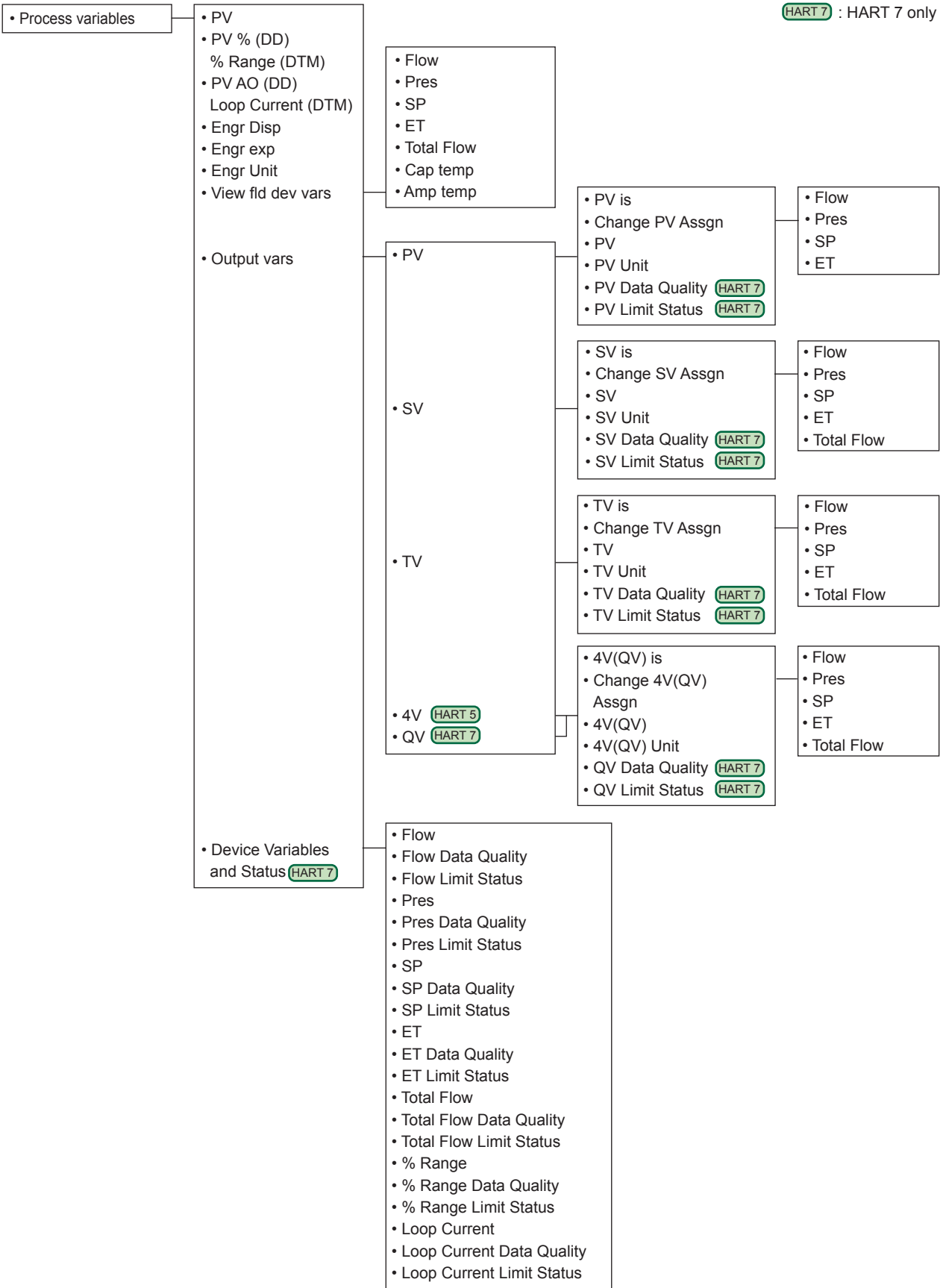

B

HART 7 : HART 7 only

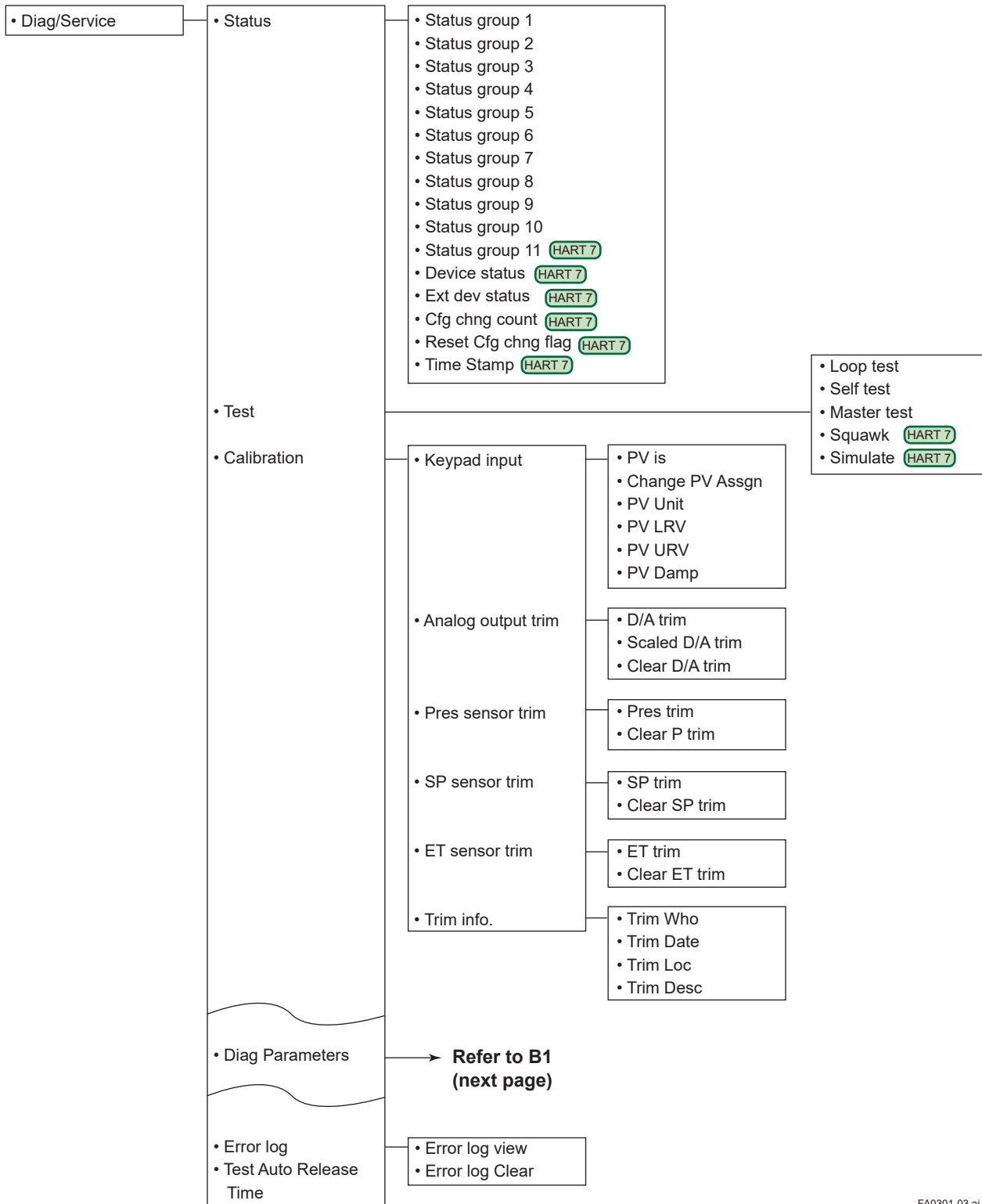

FA0301-03.ai

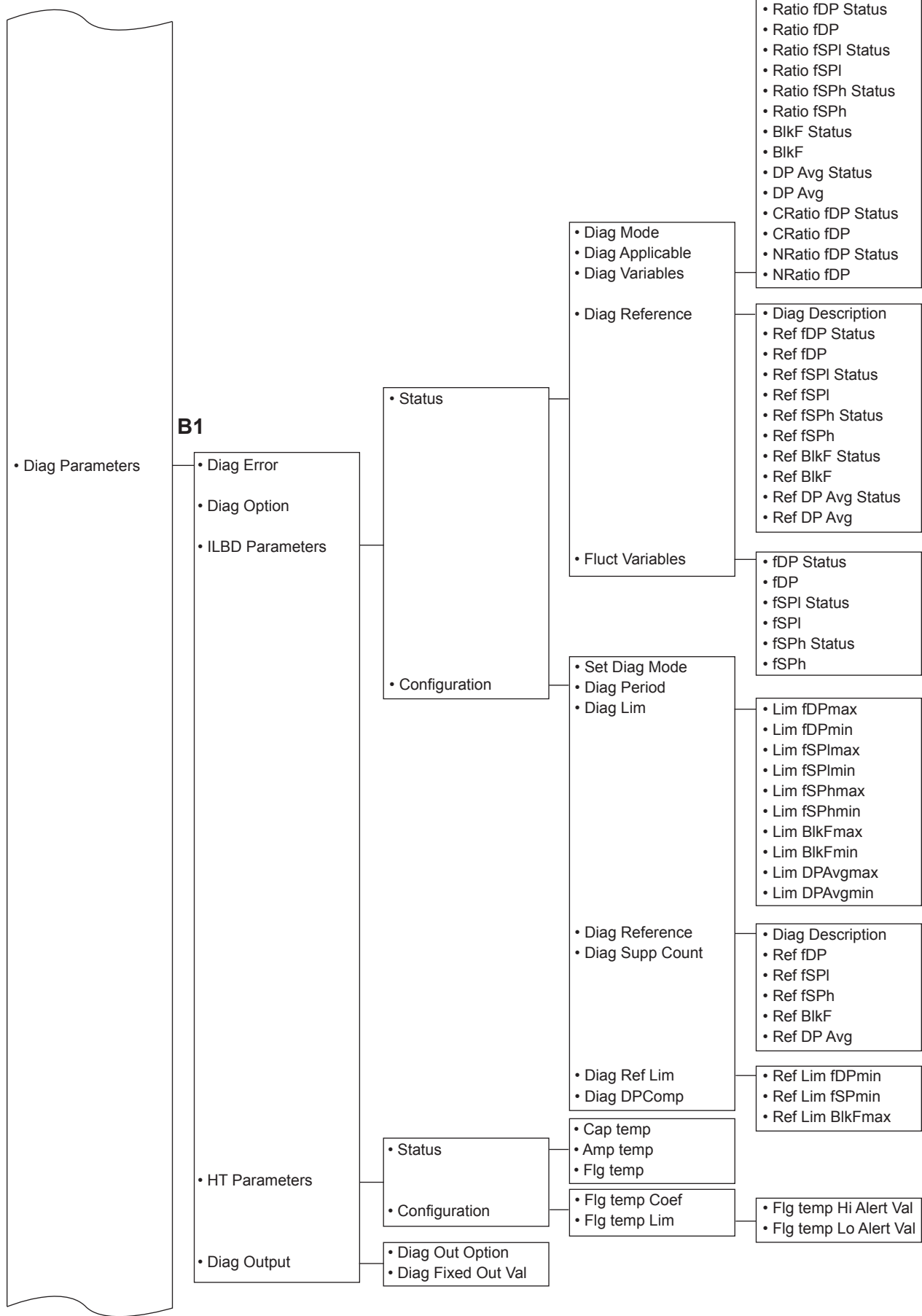

C

HART 7 : HART 7 only

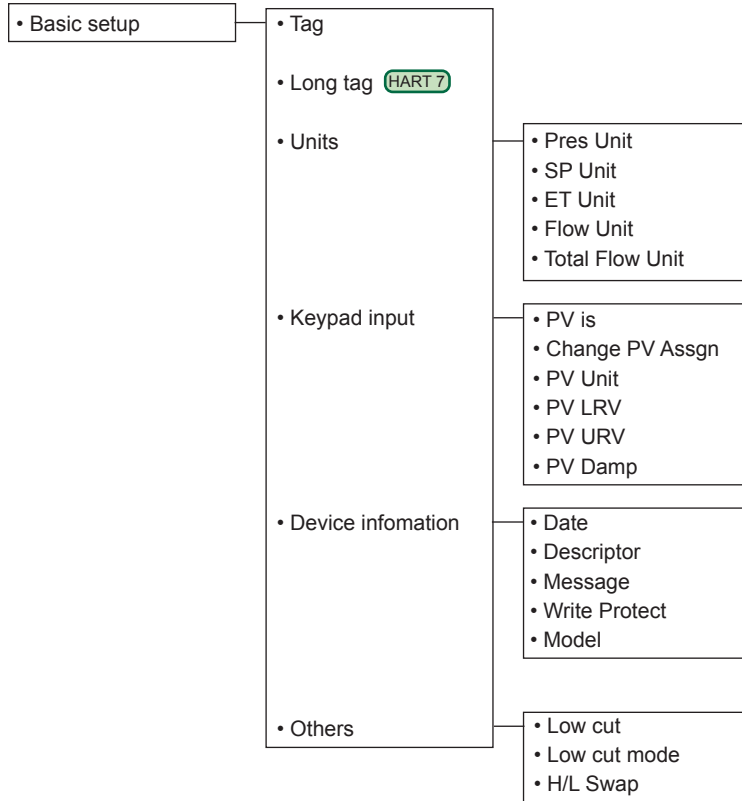

FA0301-05.ai

D

HART 5 : HART 5 only
HART 7 : HART 7 only

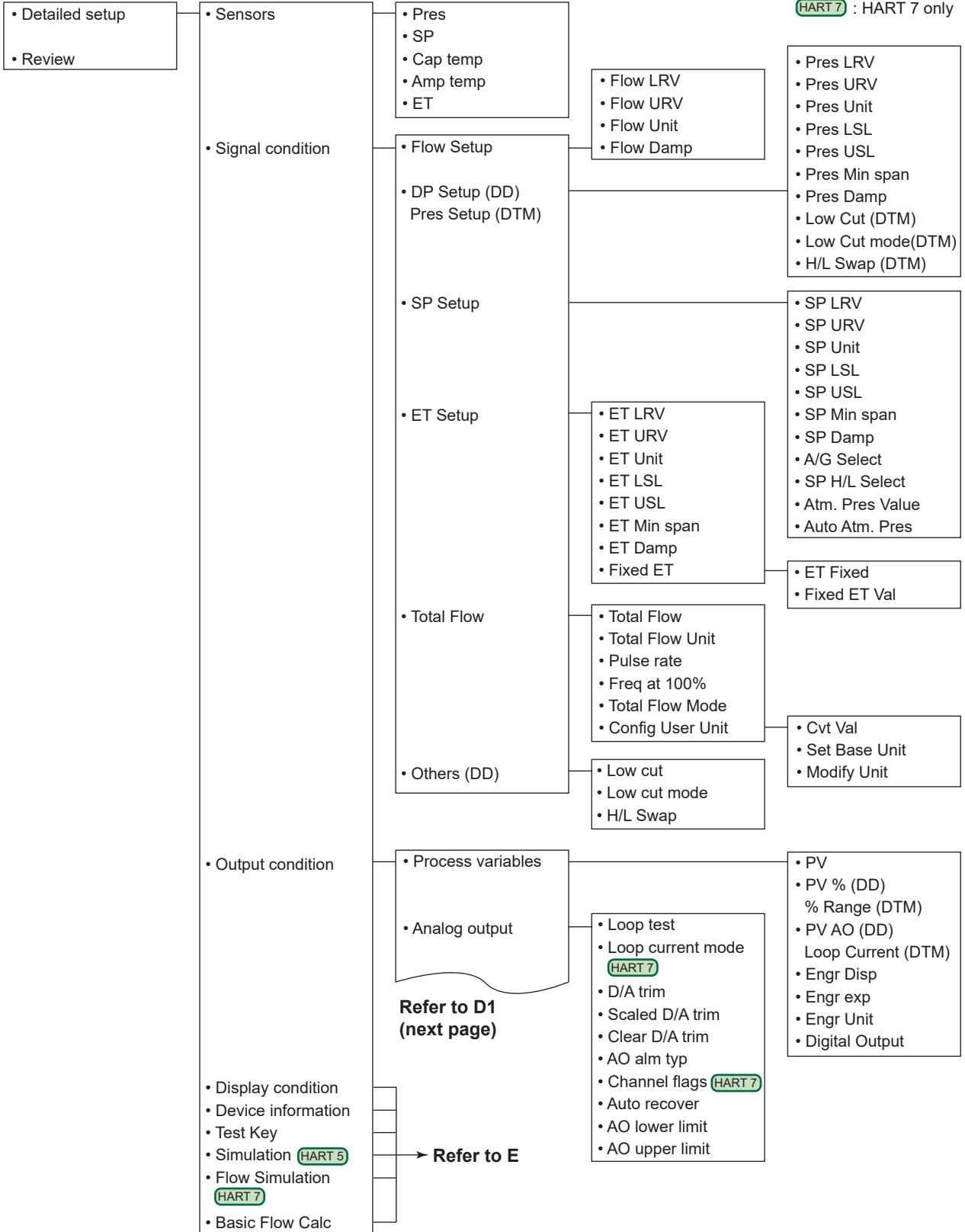

FA0301-06.ai

D1

HART 5 : HART 5 only
HART 7 : HART 7 only

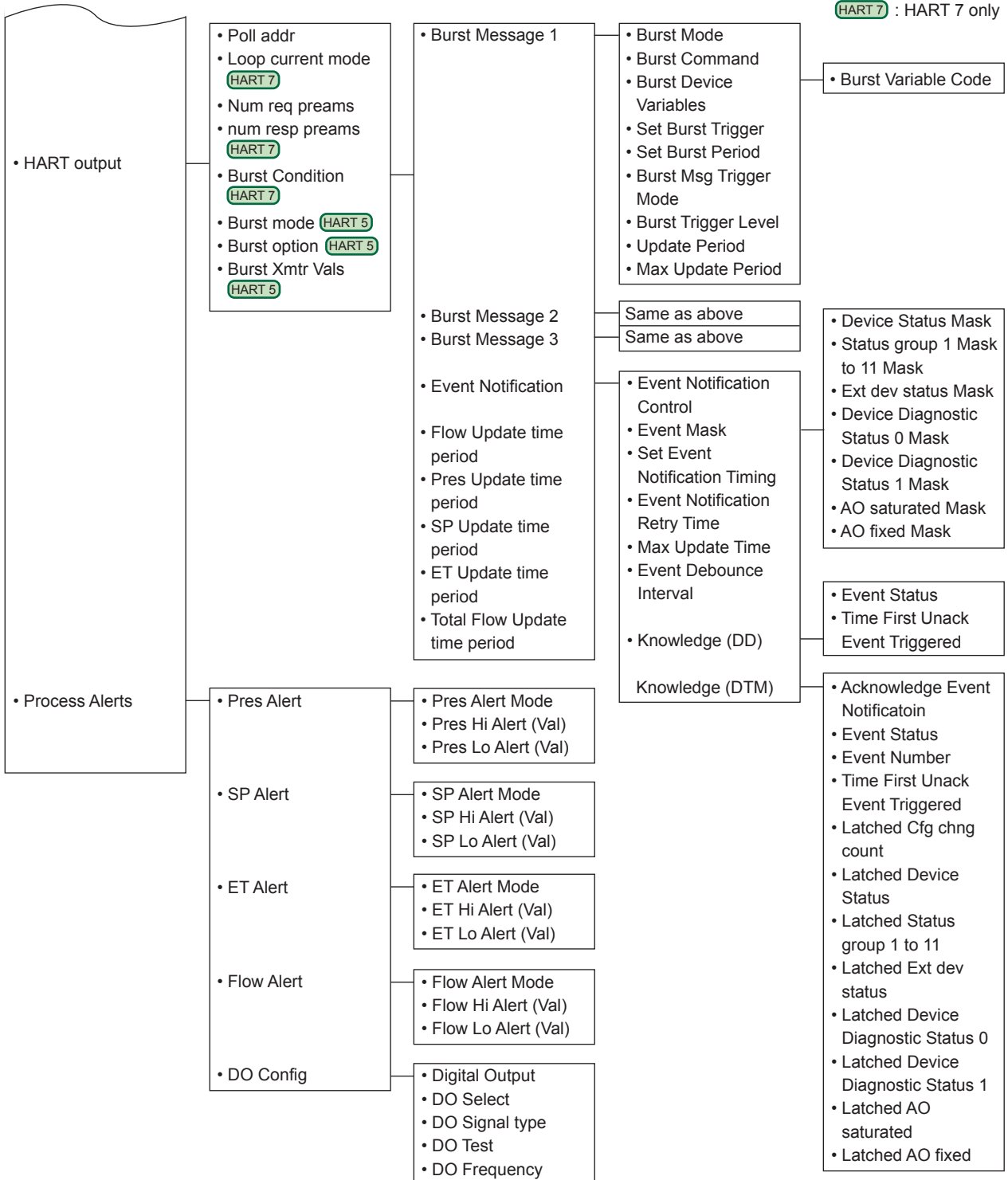

FA0301-07.ai

E

HART 5 : HART 5 only
HART 7 : HART 7 only

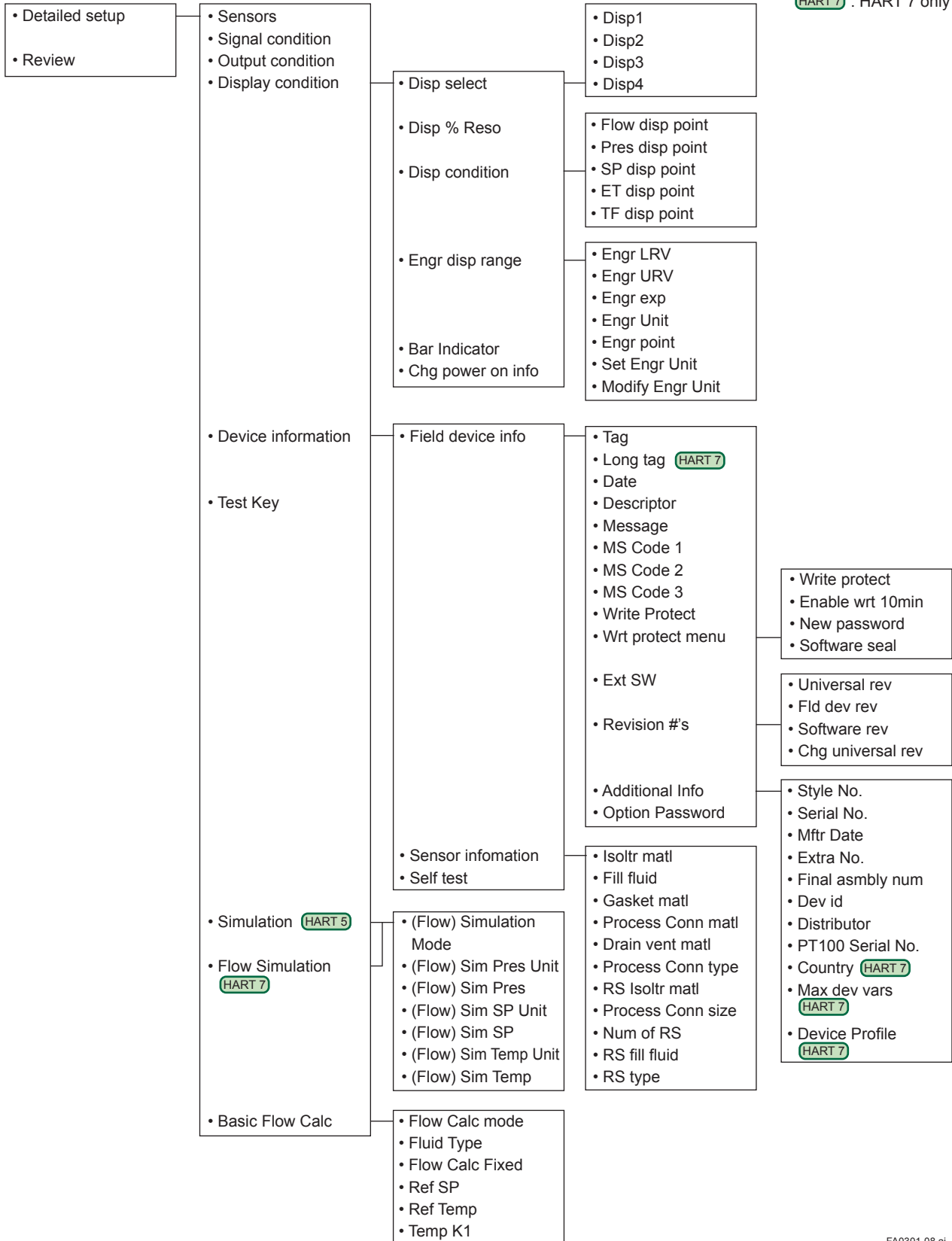

FA0301-08.ai

A3.1.2 For DTM (HART 5)

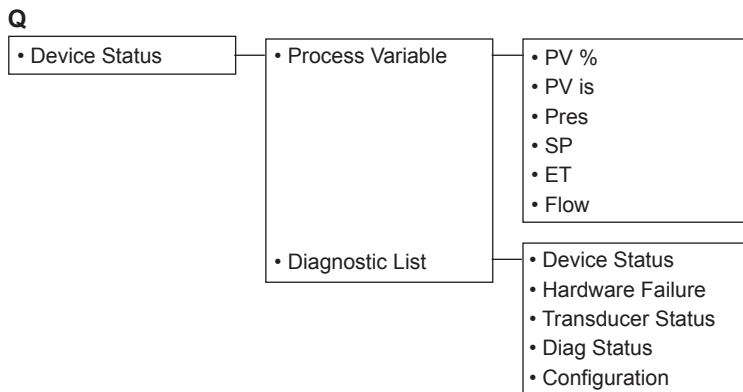
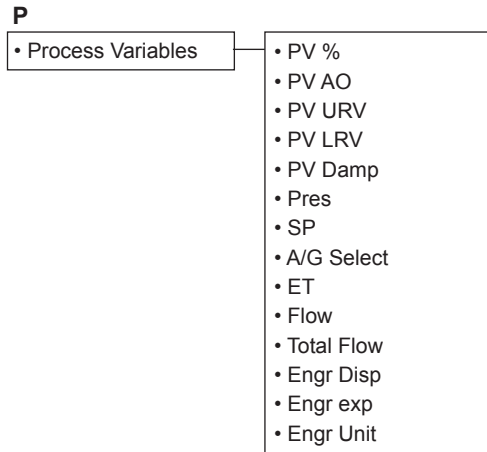
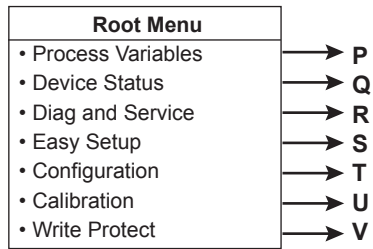

FA0301-09.ai

R

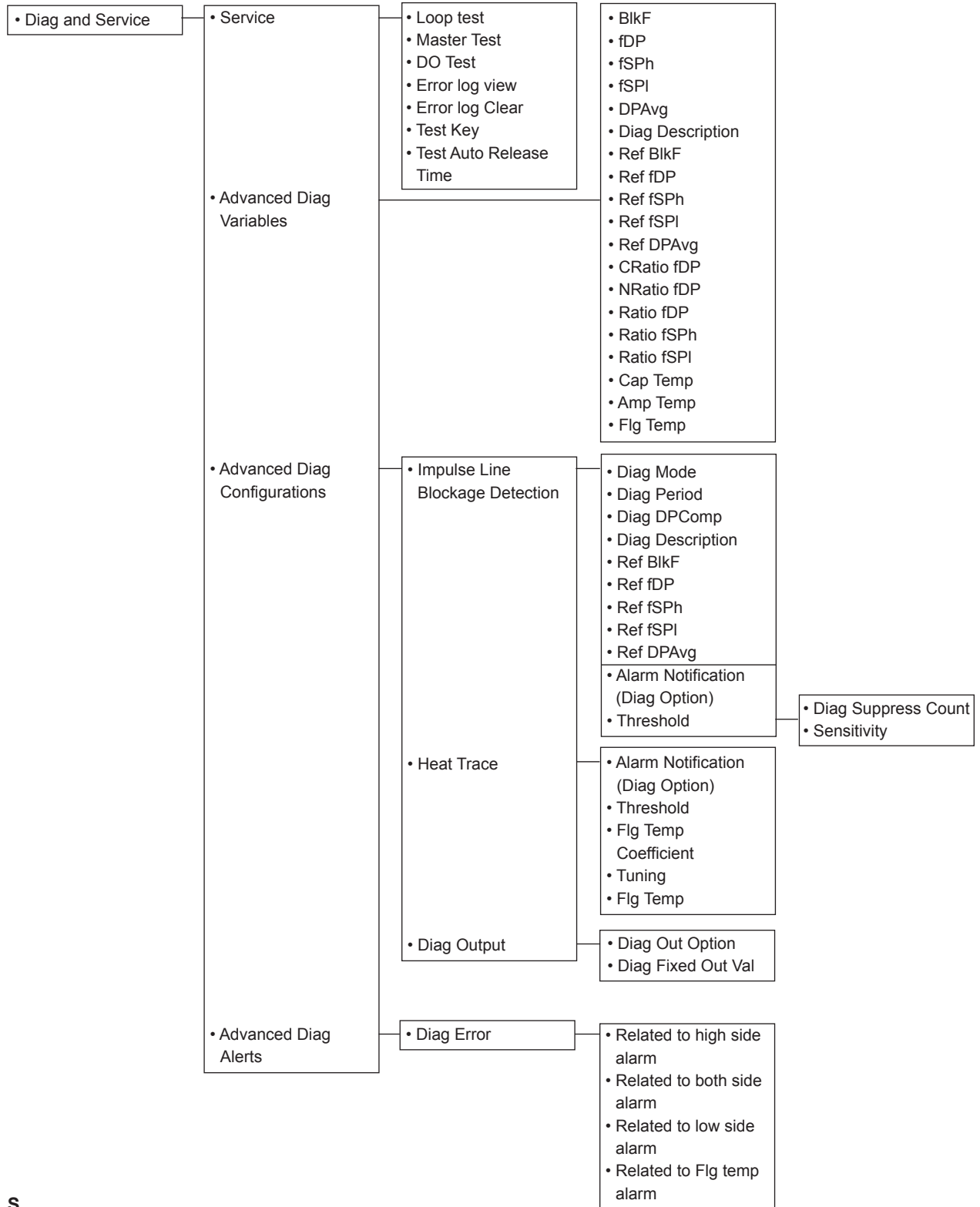

S

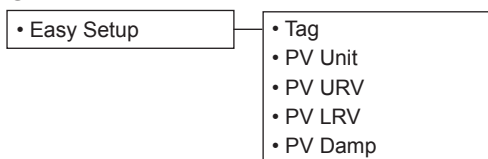

T

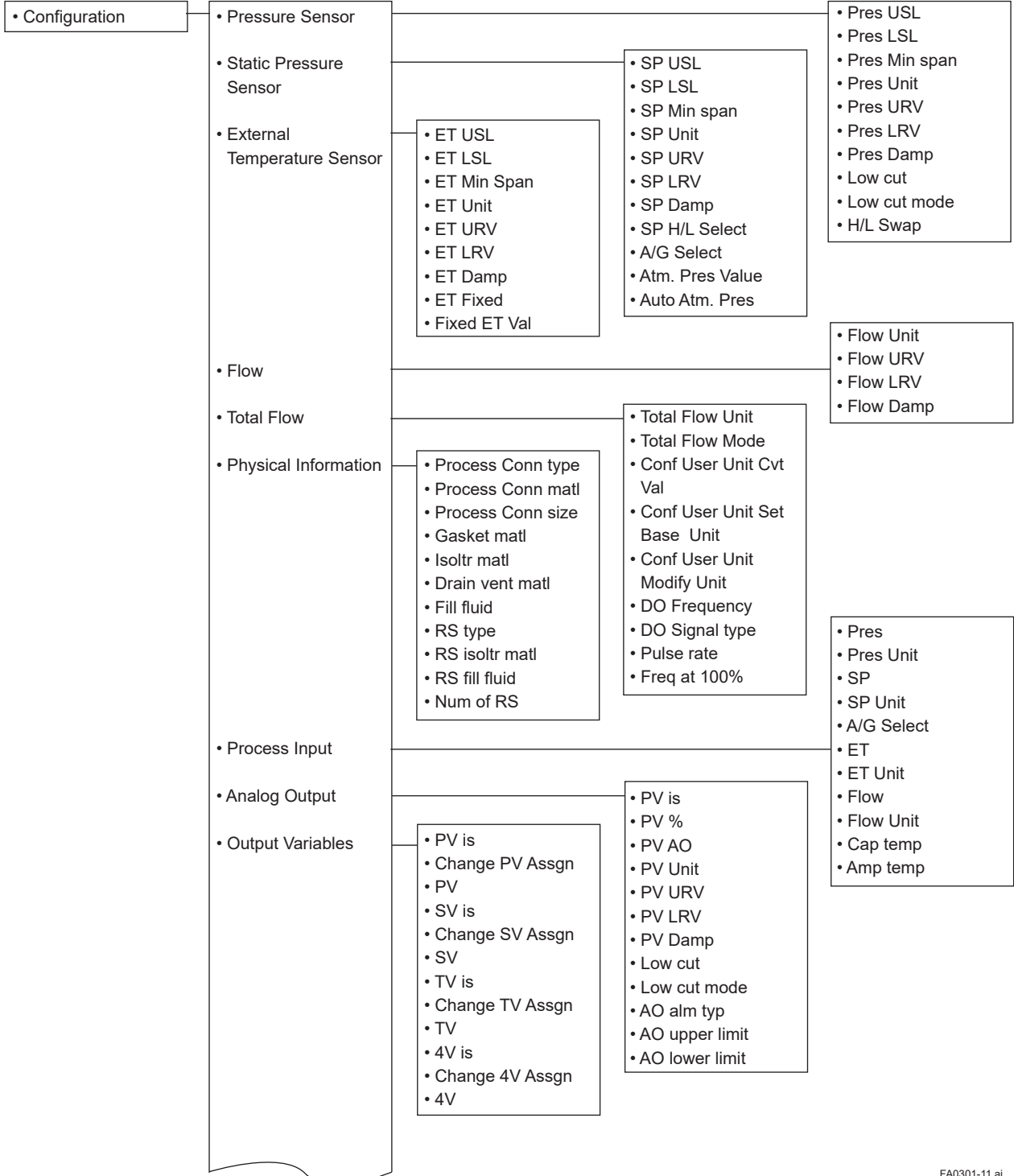

Refer to T1 (next page)

FA0301-11.ai

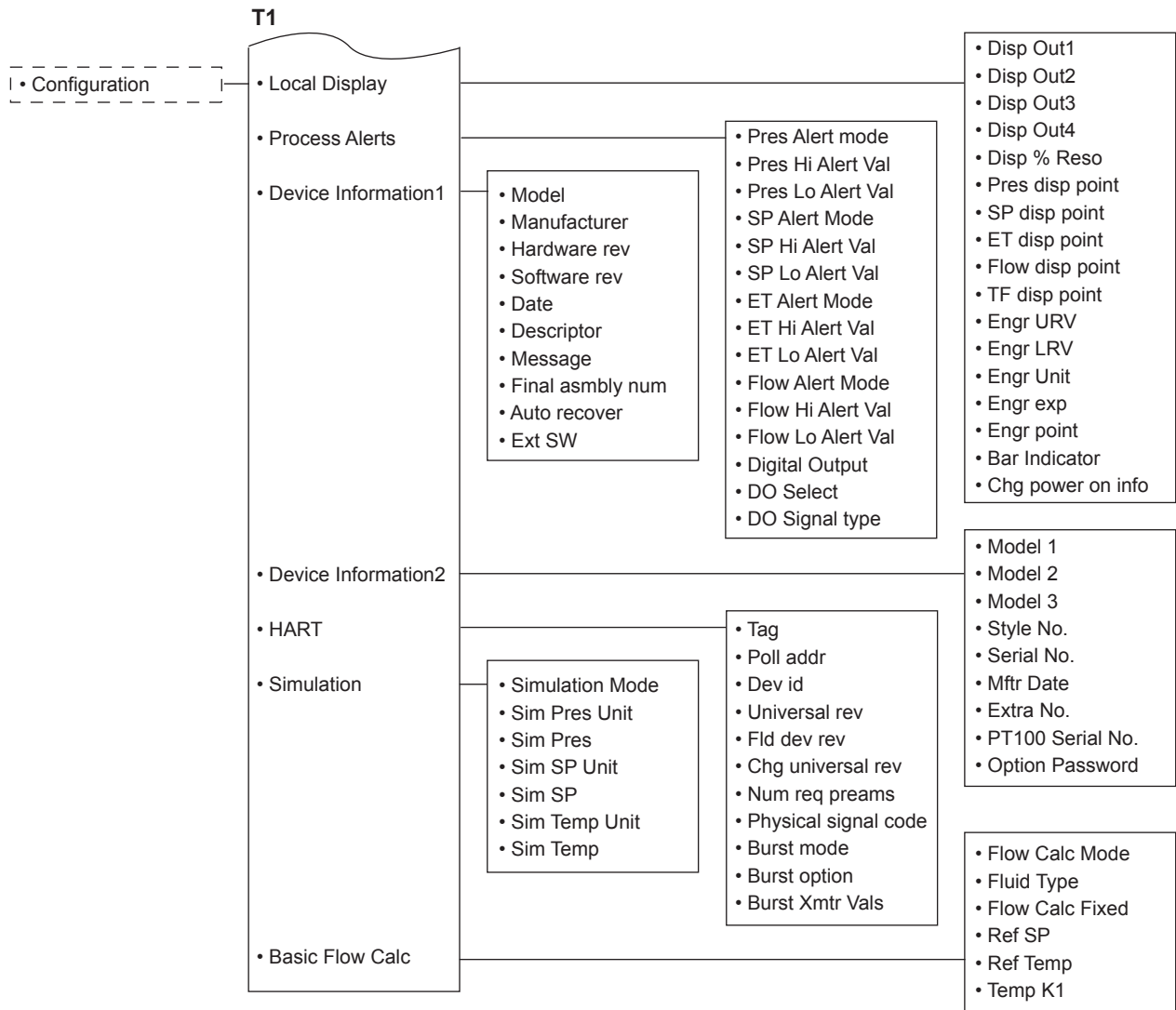

U

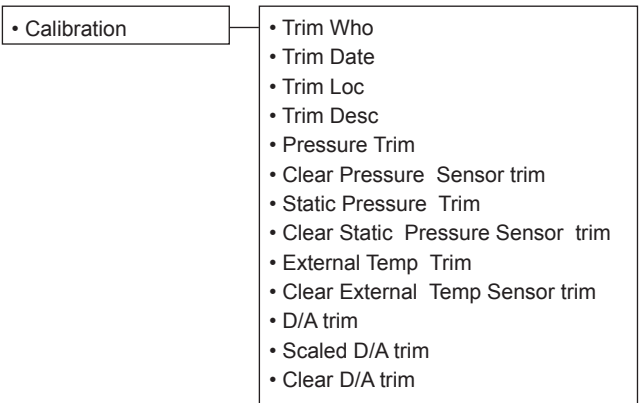

V

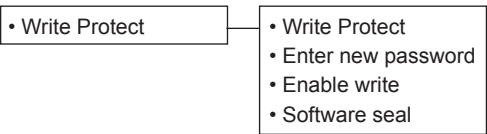

A3.2 Menu Tree (Device revision 11)

The menu tree is different in DD (HART 7), EJX910 FDT2.0 HART 7 DTM or HART built in DTM (HART 7).

See the menu tree corresponding to the configuration tool.

A3.2.1 For DD (HART 7) and DTM (HART 7)

■ DD (HART 7)

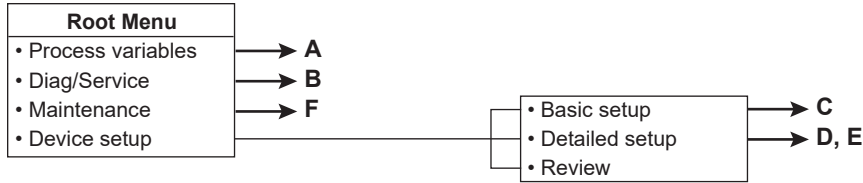

■ EJX910 FDT2.0 HART 7 DTM

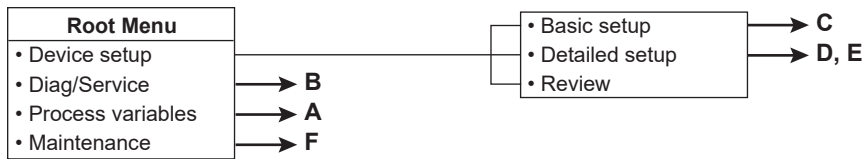

■ HART Built-in DTM (HART 7)

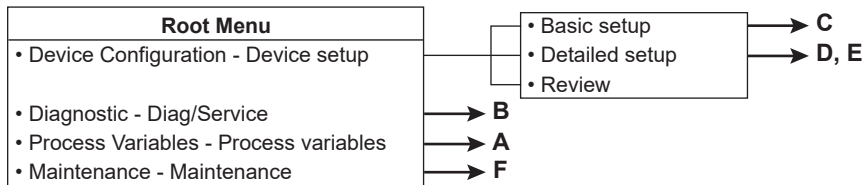

FA0302-01.ai

A

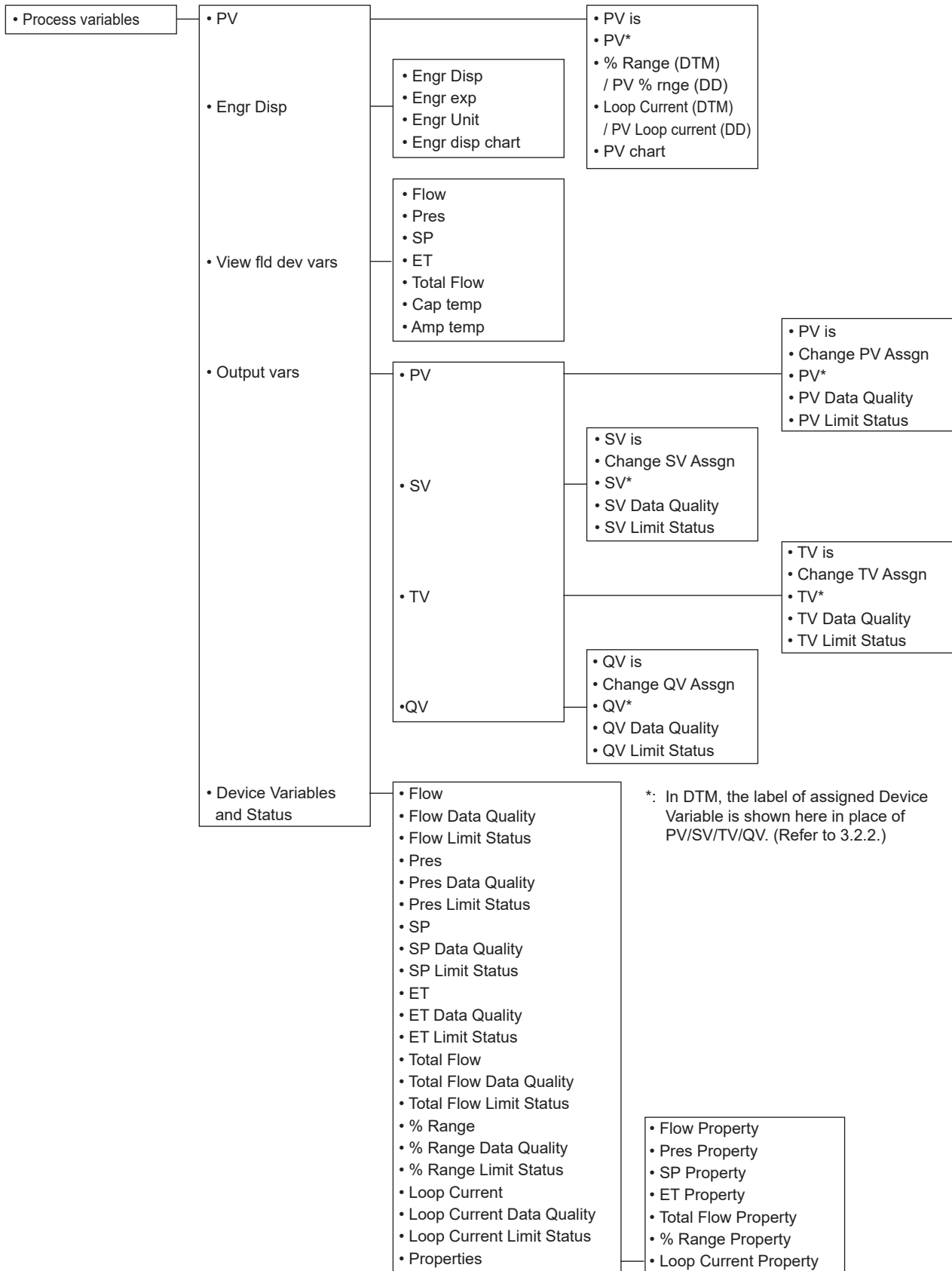

FA0302-02.ai

B

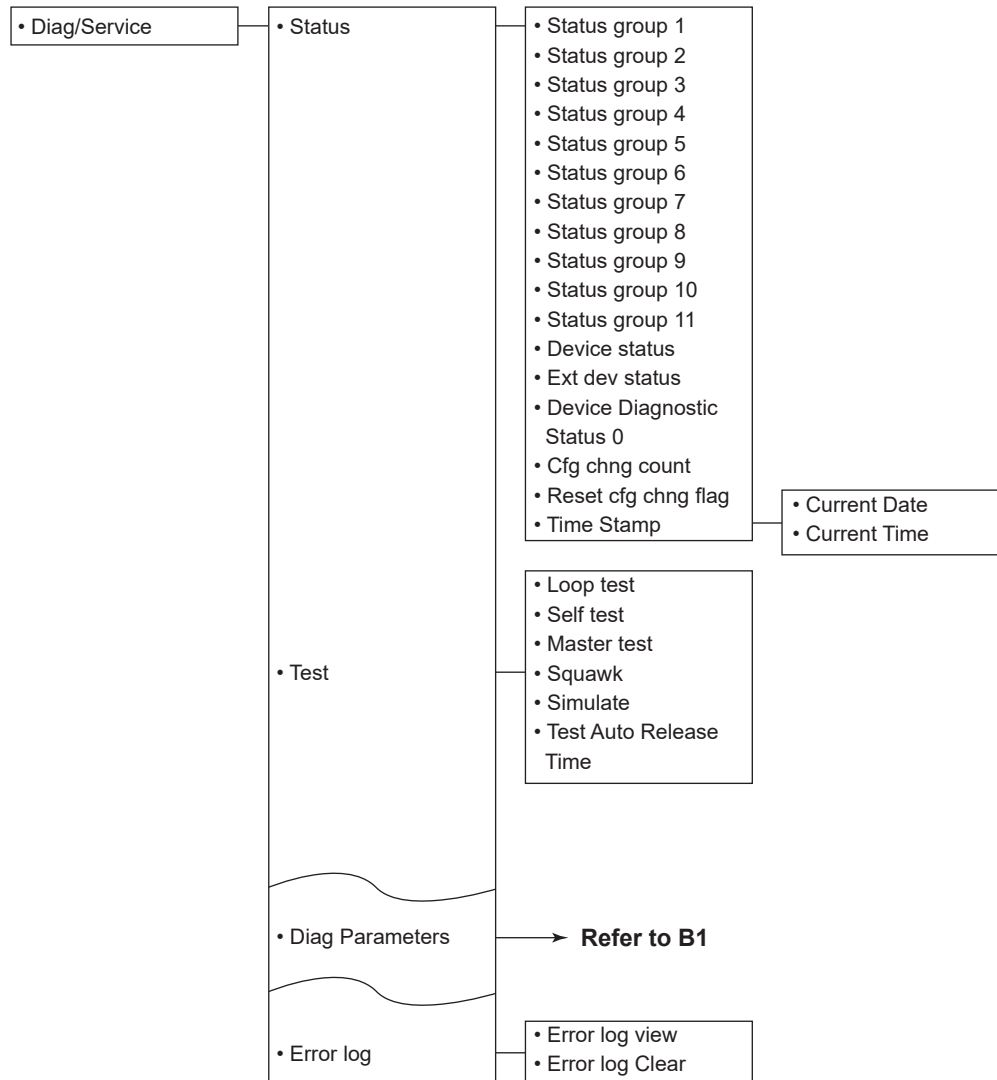

FA0302-03.ai

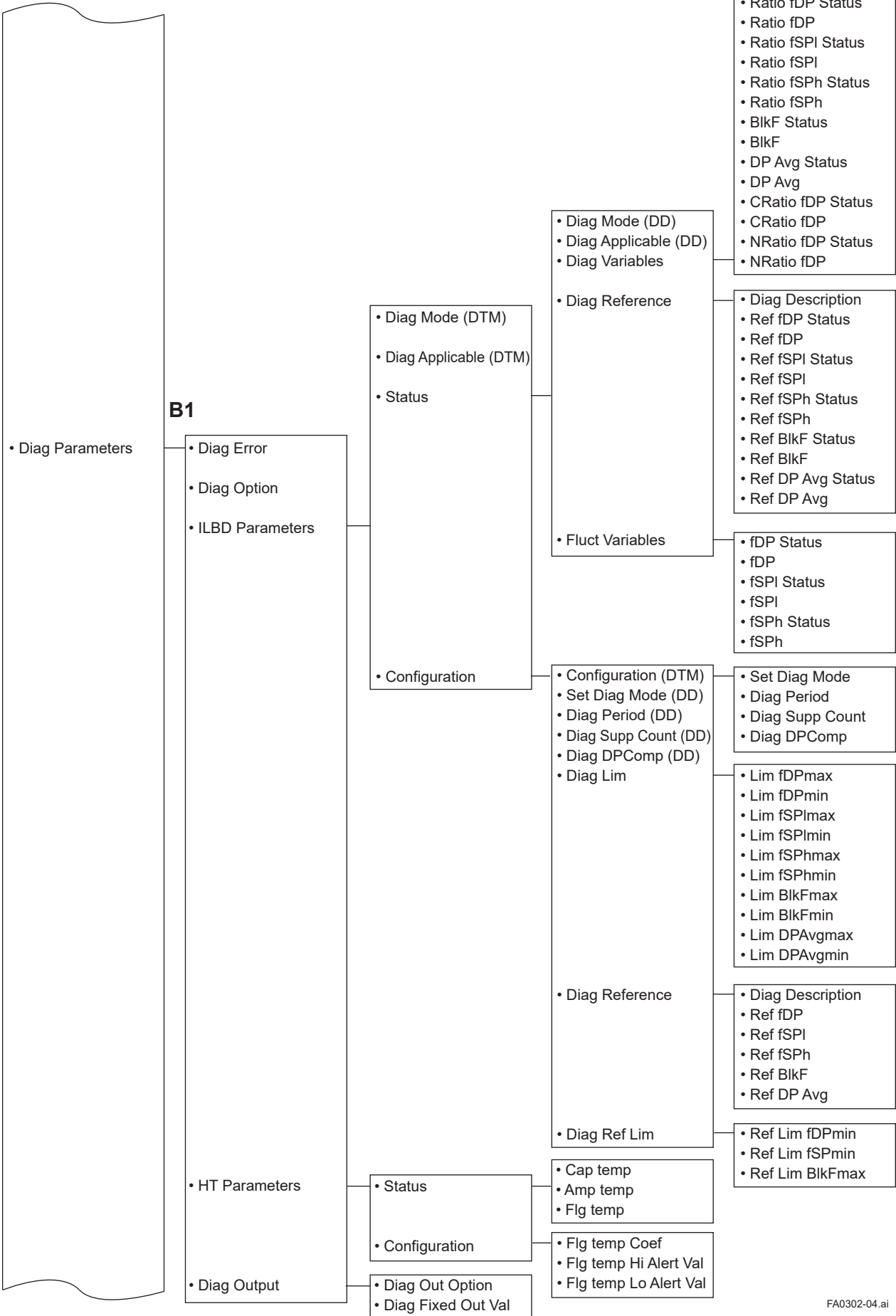

FA0302-04.ai

C

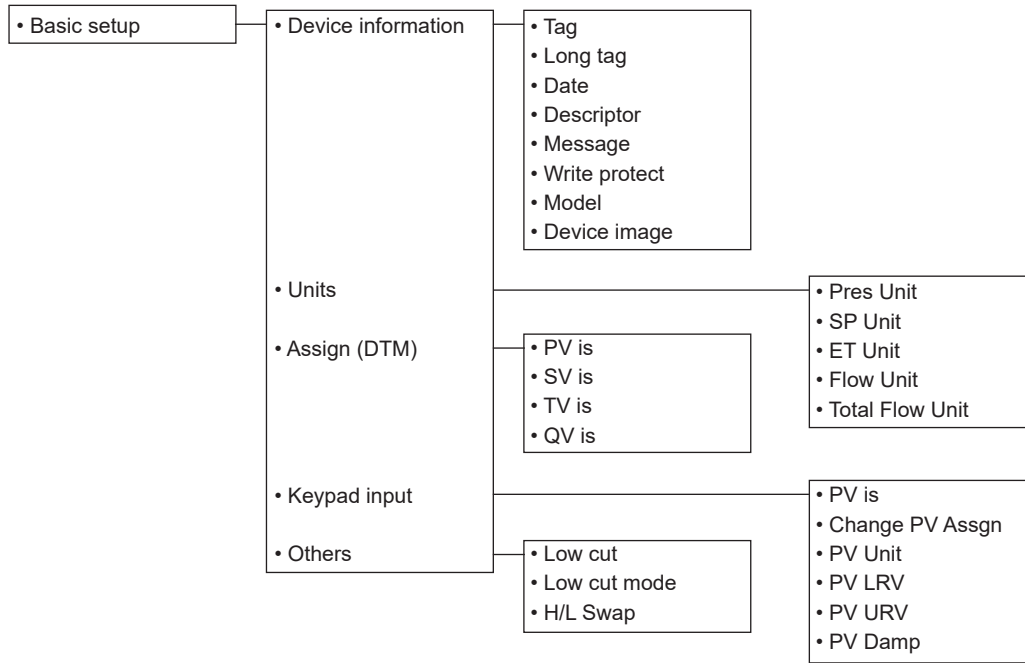

FA0302-05.ai

D

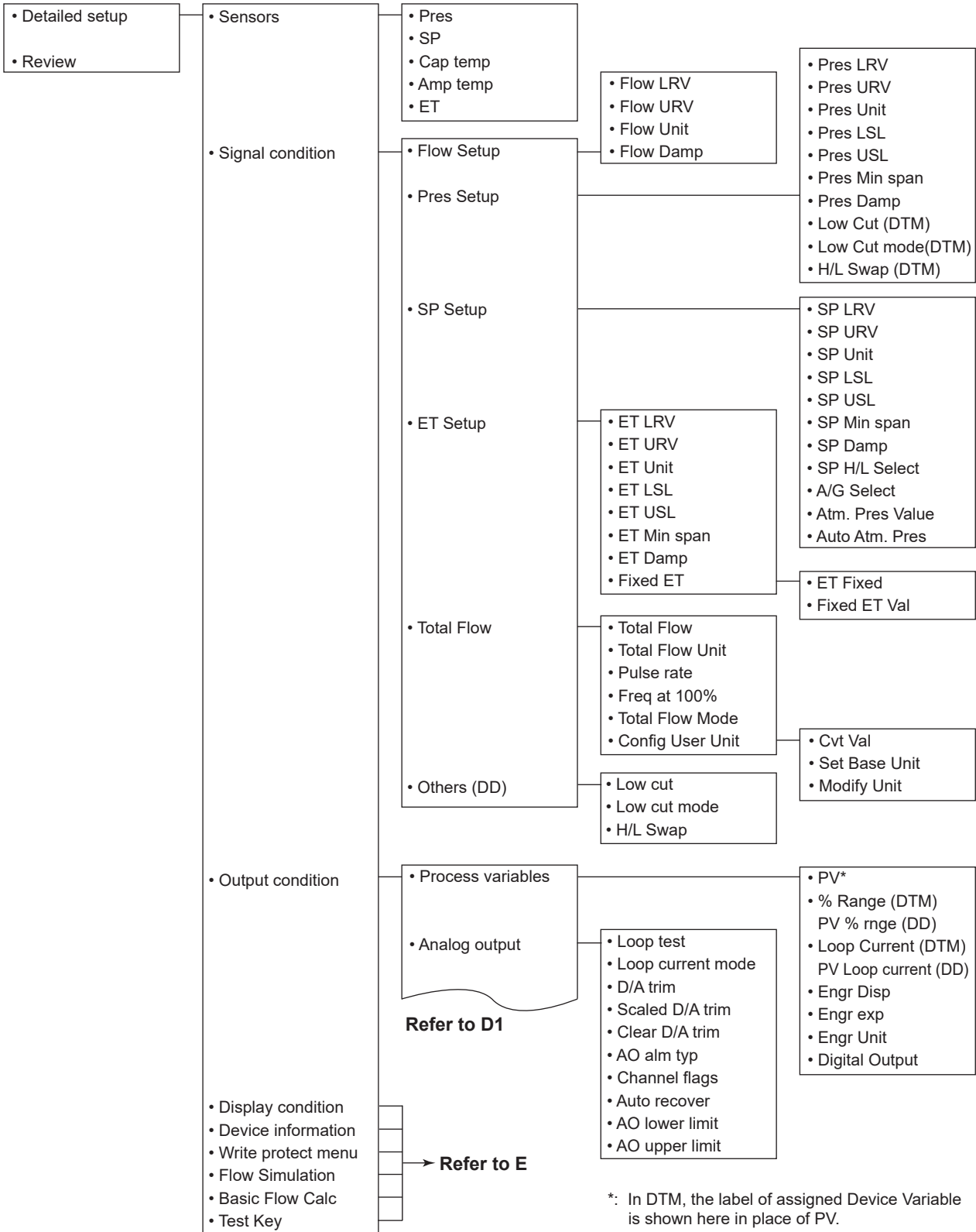

D1

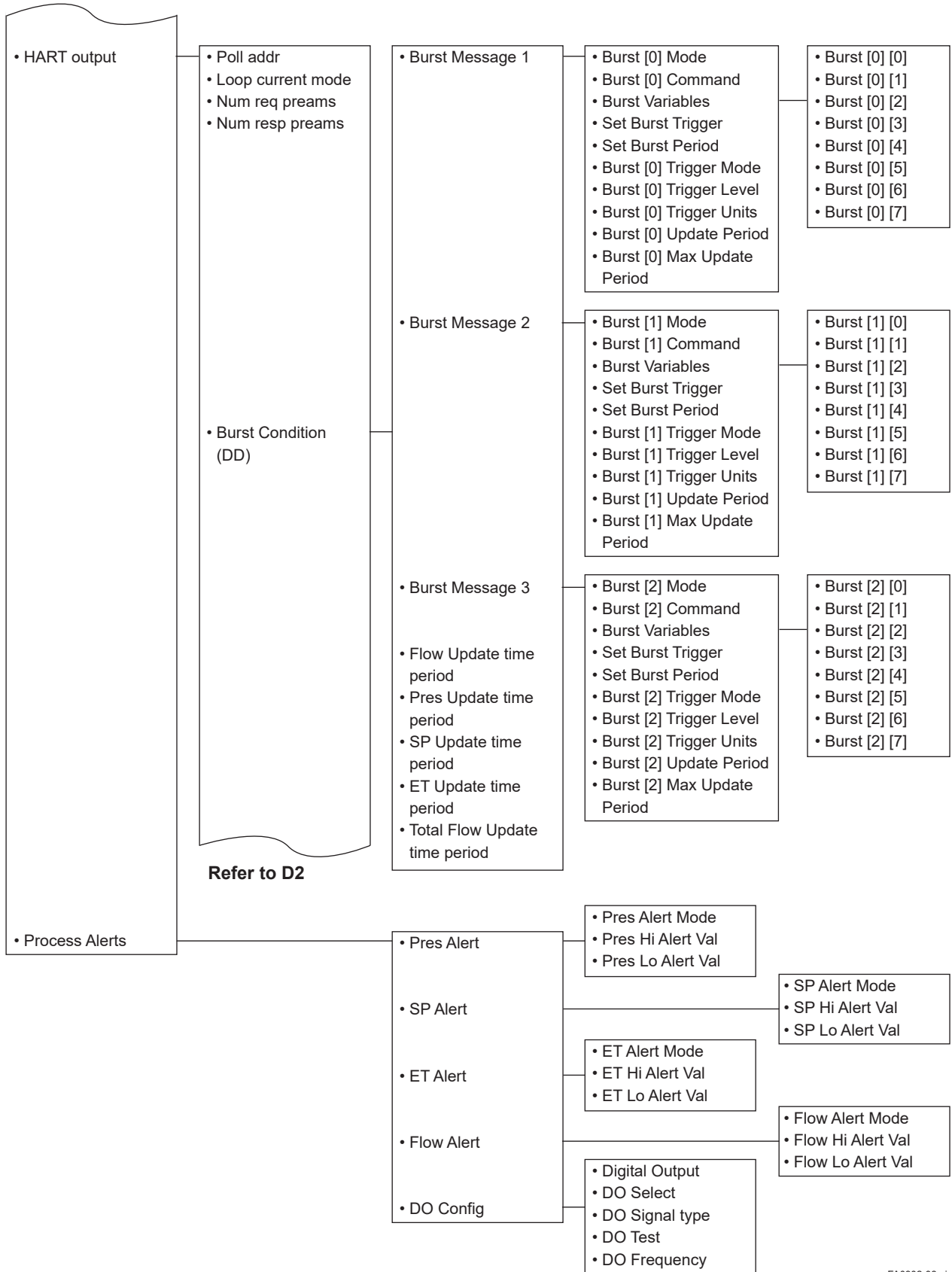

FA0302-08.ai

D2

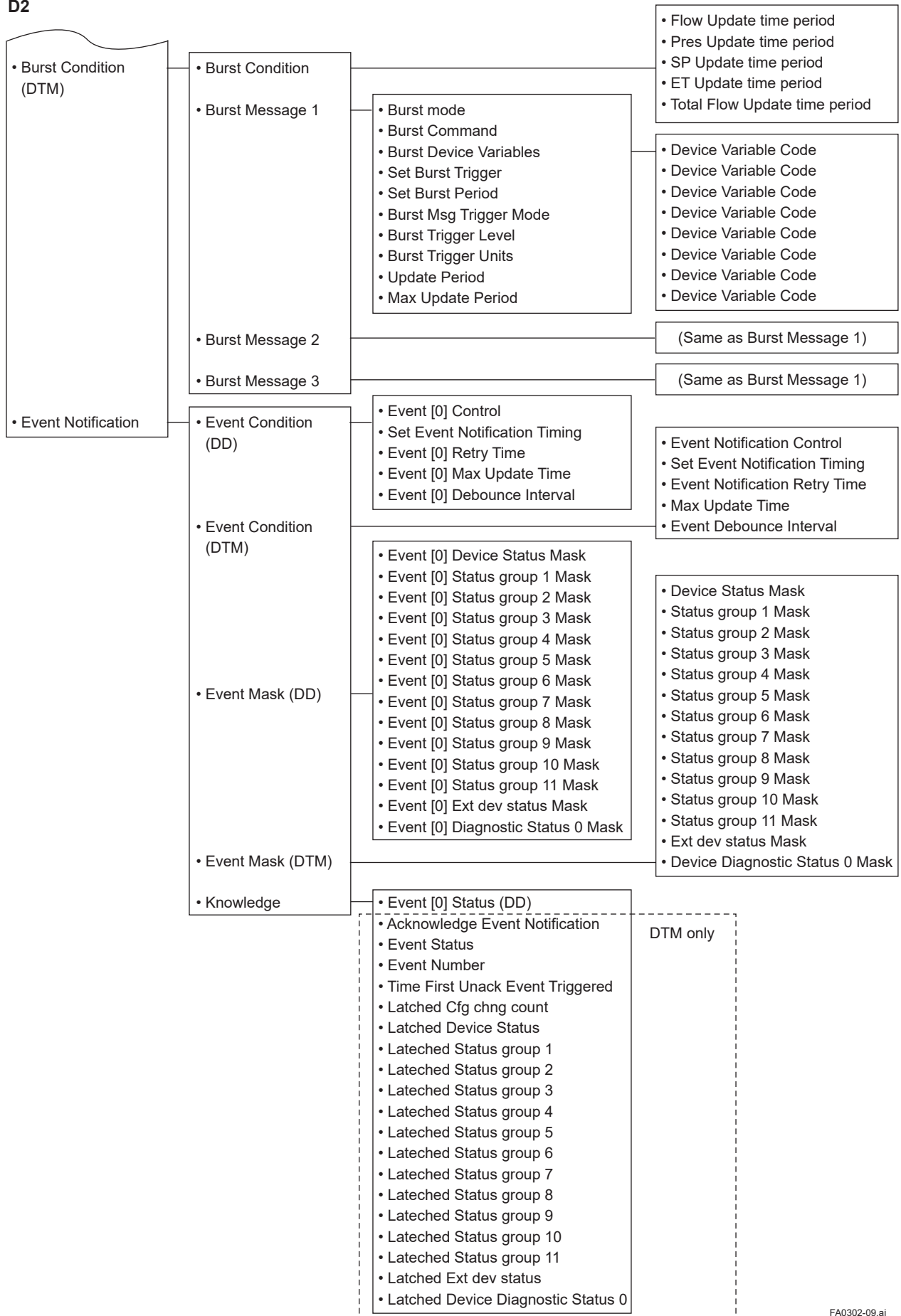

E

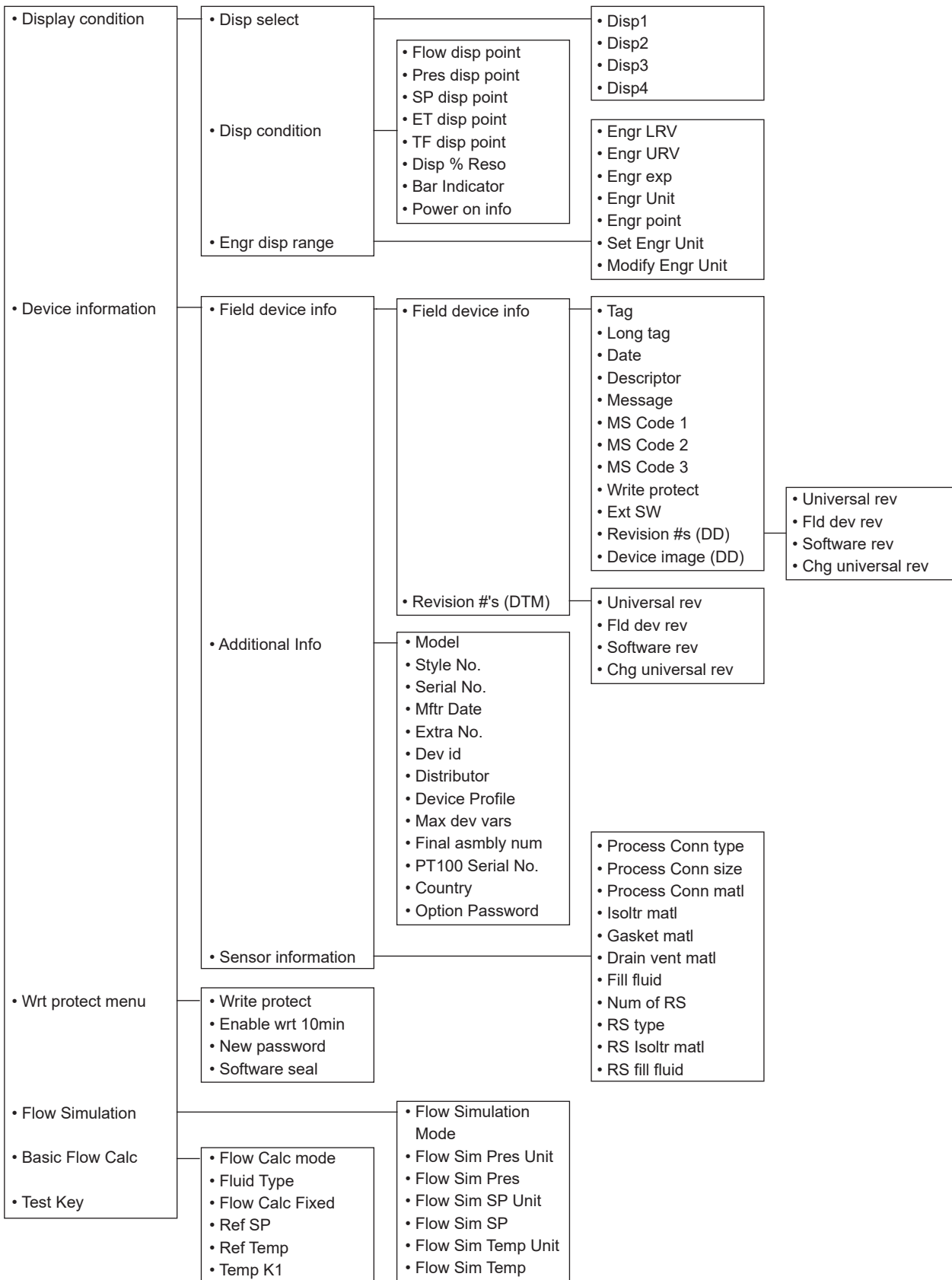

FA0302-11.ai

F

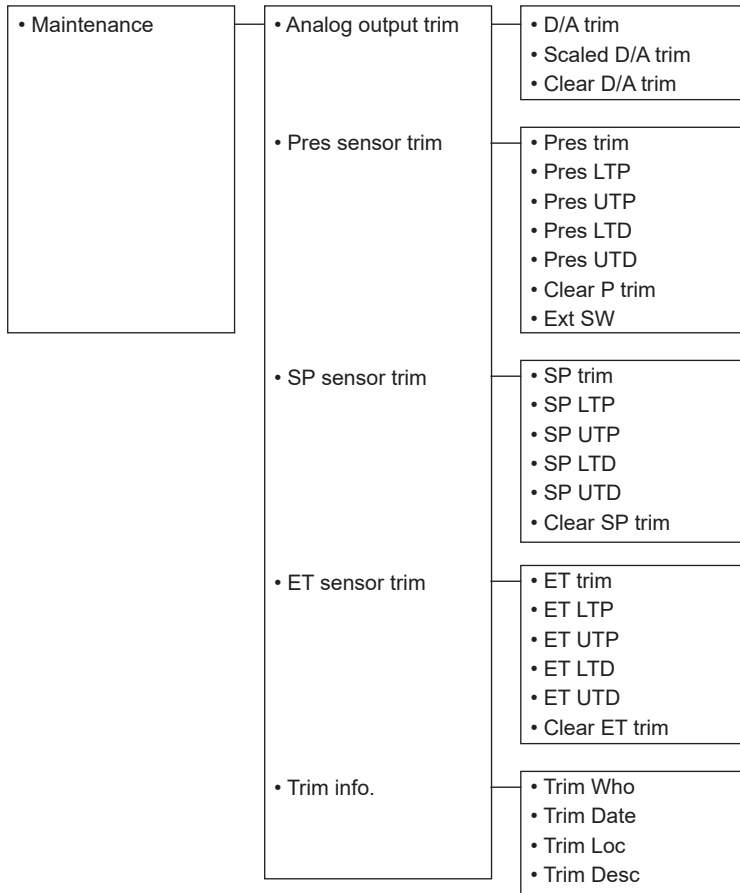

FA0302-12.ai

Revision Information

- Title : EJX910A and EJX930A
Multivariable Transmitter HART Communication Type
- Manual No. : IM 01C25R02-01E

| Edition | Date | Page | Revised Item |
|---------|-----------|--|---|
| 1st | Mar. 2005 | — | New publication |
| 2nd | Mar. 2009 | — | Add model EJX930A. |
| 3rd | Aug. 2009 | 3-25 and 3-26 3-30 | 3.5.10 Revise the description. 3.5.13 Add the detail of the status output hysteresis. |
| 4th | Apr. 2010 | 1-4 1-4 3-6 3-12 to 3-40 4-2 to 4-18 4-19 5-1 A-1 | Revise the description for device revision 2. 1.4 Revise explanation of device revision. 1.5 Add explanation of DTM. 3.3 Add Advanced diagnostic and device revision 2 upgrade function menu. 3.4, 3.5, 3.6 Add device revision 2 upgrade function operation. 4.2 Add Advanced diagnostic operation (for option code /DG6). 4.3 Add alarms regarding Advanced diagnostic. 5 Add Advanced diagnostic and device revision 2 upgrade function parameters. Appendix 1 Add check list for ILBD. |
| 5th | July 2011 | | Add HART 7 |
| 6th | Mar. 2012 | 2-3 3-6 3-13 | 2.4 Revise revision information in Table 2.2. 3.1.1 Add parameters in the Pres Setup (DTM) menu. 3.2.1 Change the limitation of 'Date' in the table. |
| 7th | June 2014 | 3-22, 5-2 | Revise default value of External Switch Mode. |
| 8th | Jan. 2018 | — | Correspond to HART 7 Device Revision 11. (Expansion of applicable primary elements.) Safety Manual (Appendix 1) is updated. |
| 9th | Oct. 2022 | — | Correspond to HART 7 Device Revision 12. Saturated Steam in ET fixed mode is updated as new function. Appendix 1 and 3 are updated. |