

## 1. INSPECTION

This instrument has been thoroughly tested at the factory before shipment. When you receive it, visually inspect it for damage and check the accessories.

### 1.1 Model number and specification check

Check to see the model number and specifications on the nameplate attached to the front face of the distributor are as ordered.

### 1.2 Contents of the instruction manual

This instruction manual provides instructions on mounting, external wiring and maintenance.

## 2. GENERAL

This instrument is used together with 2-wire transmitter to feed power to it. It receives 4~20mA DC signal and converts it into isolated current or voltage signal.

Accessories : Mounting block 2  
Tag number label 1  
Mounting screw M4 2

## 3. MOUNTING METHOD

JUXTA signal conditioners can be mounted on rack, wall or DIN rail.

### 3.1 Rack mounting

Use panel (FRK-16) and install it on an angle as shown in Fig.1. This is a convenient method for high density mounting of the distributors on 19-inch rack panel. (See Fig. 6)

### 3.2 Wall mounting

Use panel (FRK-16) to mount the distributor on the wall as shown in Fig.2 or directly mount the single unit on the wall. (See Figs. 6 and 7 for mounting dimensions)

### 3.3 DIN rail mounting

Insert DIN rail into the upper section of DIN rail groove on the rear of the distributor and fix the rail with the slidlock at the base of the distributor as shown in Fig.3.

### 3.4 Angle mounting

As for mounting of single unit of distributor, refer Fig.5 for its mounting.

### 3.5 Mounting block installation and removal

Insert mounting block into groove of distributor and slide it until it is fixed with the stopper as shown in Fig. 4. To remove it, lift up mounting block stopper with (-)screwdriver and slide it along the groove.

FIG.1 RACK MOUNTING

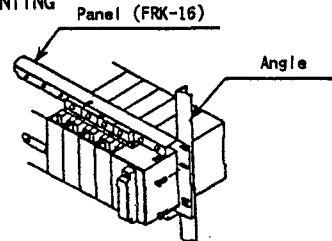

FIG.2 WALL MOUNTING

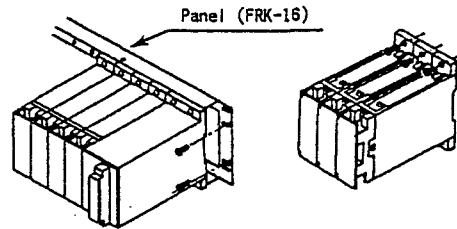

FIG.3 DIN RAIL MOUNTING

Use (-) screwdriver and lower the slidlock to remove the distributor from DIN rail

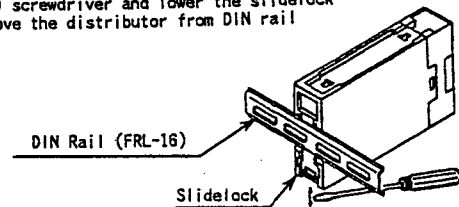

FIG.4 MOUNTING BLOCK INSTALLATION AND REMOVAL

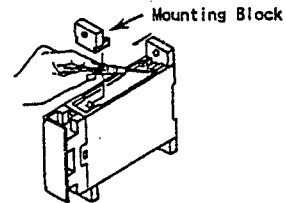

FIG.5 ANGLE MOUNTING DIMENSION

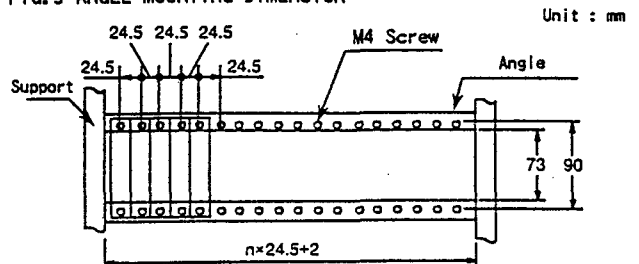
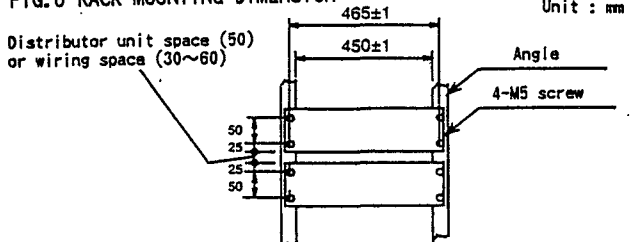

FIG.6 RACK MOUNTING DIMENSION



#### 4. EXTERNAL WIRING

Open distributor terminal cover and wire on M4 screw terminals. Flexible twisted wires and good contact of durable round crimp-on terminals (JIS C2805) are recommended to be used.

● Signal cable having more than  $0.5\text{mm}^2$  and power cable having more than  $1.25\text{mm}^2$  of nominal cross-sectional area of conductor are recommended.

##### 4.1 Wiring

- ① See Fig.8 for terminal arrangement.
- ② Connect 4~20mA DC signal cable from 2-wire transmitter to distributor terminals 1(+) and 2(-). (See Fig.9) If external power supply is used, connect power cable to distributor terminals 2(+) and 3(-). (See Fig.9)
- ③ Connect distributor output signal cable to its terminals 4(+) and 5(-).
- ④ Connect 24V DC power cable to distributor terminals 6(+) and 7(-). (See Fig.9)

#### 5. ITEMS TO BE CHECKED BEFORE TURNING THE POWER SWITCH ON

- ① Make sure that 24V DC power cable of the distributor is connected to the correct polarities (+) and (-).
- ② Confirm that the external wiring to the terminal board is correct.
- ③ Check that mounting, ambient temperature, humidity, dust and vibration are normal. Confirm the above items before turning the power on. The distributor needs 5 minutes warmup to meet its specified accuracy level.

#### 6. MAINTENANCE

##### CAUTION

Carry out the following calibration after warming up the equipment for more than 5 minutes.

##### 6.1 Calibration equipment

- Voltage/current generator (Yokogawa model 7651 or equivalent) 1
- Voltmeter (Yokogawa model 7551 or equivalent) 1
- Precision resistor,  $250\Omega \pm 0.01\%$ , 1W 1 (in case of current output)

##### 6.2 Calibration

- ① Connect each equipment as shown in Fig.10.
- ② Input/output characteristics check  
Use voltage/current generator and apply current input signals equivalent 0, 25, 50, 75, 100% of input span to the distributor. Check to see the corresponding distributor outputs are 0, 25, 50, 75, 100% of output span respectively and are within accuracy rating range.

\*If output signal is out of tolerance, adjust it with span and zero adjustment trimmer on front face of the instrument.

FIG.7 PANEL (WALL) MOUNTING DIMENSION

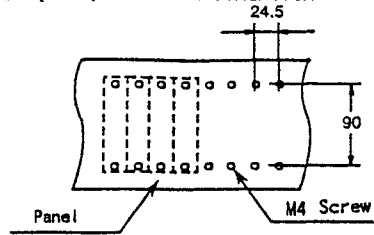

FIG.8 TERMINAL ARRANGEMENT

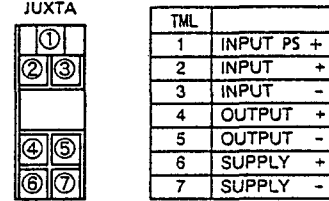

FIG.9 WIRING DIAGRAM

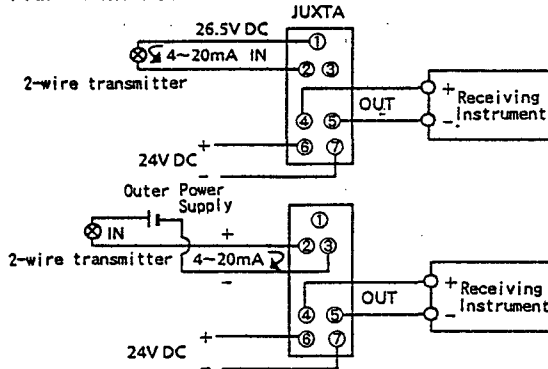
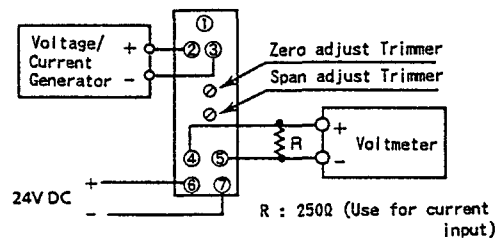

FIG.10 WIRING OF CALIBRATION EQUIPMENT



Subject to change without notice for grade up quality and performance.