

Sensor Integration Gateway - SIG100

Integration Products

SICK
Sensor Intelligence.



Described product

SIG - Sensor integration gateway
SIG100

Manufacturer

SICK AG
Erwin-Sick-Str. 1
79183 Waldkirch
Germany

Production location

SICK PCA
55438 Minneapolis, MN
USA

Legal information

This work is protected by copyright. Any rights derived from the copyright shall be reserved for SICK AG. Reproduction of this document or parts of this document is only permissible within the limits of the legal determination of Copyright Law. Any modification, abridgment or translation of this document is prohibited without the express written permission of SICK AG.

The trademarks stated in this document are the property of their respective owner.

© SICK AG. All rights reserved.

Original document

This document is an original document of SICK AG.

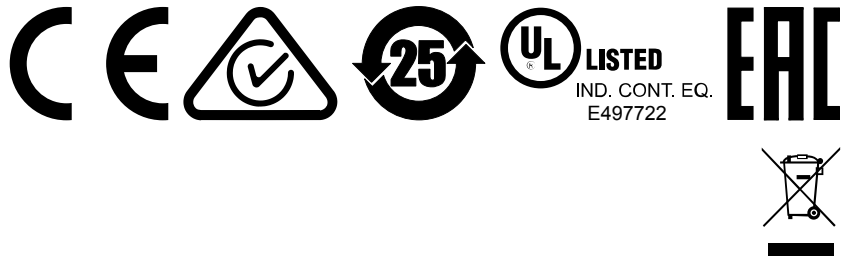

Contents

1	Safety notes.....	4
2	Correct use.....	5
3	Operating and status indicators.....	6
4	Transport and storage.....	8
	4.1 Transport.....	8
	4.2 Transport inspection.....	8
	4.3 Storage.....	8
5	Mounting.....	9
6	Electrical installation.....	10
	6.1 DC.....	10
7	SIG100 configuration.....	12
	7.1 Operation via SOPAS ET.....	12
	7.2 Operation via IO-Link.....	21
	7.3 Device functions.....	24
	7.4 Logic Editor.....	24
8	Troubleshooting.....	43
9	Disassembly and disposal.....	44
10	Maintenance.....	45
11	Technical data.....	46
	11.1 General technical data.....	46
12	Annex.....	48
	12.1 Technical Information.....	49
	12.2 About this document.....	50
	12.3 Description of IO-Link.....	50
	12.4 Accessories for visualization, configuration and integration.....	51
	12.5 Data repository.....	51
	12.6 Physical Layer.....	51
	12.7 Process data.....	52
	12.8 Service data.....	55
	12.9 Events.....	63
	12.10 Errors.....	63
	12.11 Index.....	65
	12.12 List of abbreviations.....	66

1 Safety notes

- Read the operating instructions before commissioning.
- Connection, mounting, and setting may only be performed by trained specialists.
- Not a safety component in accordance with the EU Machinery Directive.
- When commissioning, protect the device from moisture and contamination.
- These operating instructions contain information required during the life cycle of the product.
- This is a class A product. In a household environment, this device can cause radio interference. The user should take appropriate measures as required.

2 Correct use

The Sensor Integration Gateway SIG100 is an IO-Link sensor hub that collects multiple discrete sensor inputs and provides multiple discrete outputs. It can stand alone or act as an IO-Link Slave to efficiently transmit the data for all connected devices. An IO-Link Master is required if the SIG100 is used as an IO-Link Slave. Up to 12 discrete inputs or outputs can be connected to the SIG100 when using a T-junction to split the pin 2 and pin 4 signal on each of the six sensor ports (S1-S6). A special benefit of Sensor Integration Gateway SIG100 is that all connected devices can be interconnected via logic functions. This is possible due to the implemented logic editor which can be accessed via the user interface SOPAS ET. For the visualization a browser capable Notebook/PC can be used. The necessary software SOPAS ET can be downloaded from www.sick.com.



NOTE

The use of an IO-Link-Master is NOT mandatory. SIG100 can be used in SIO mode. An IO-Link Master is only required if the SIG100 needs to operate as an IO-Link Slave. Furthermore, SIG100 can be used as a stand alone controller without any additional PLC.

Table 1: SIG100 Implementation

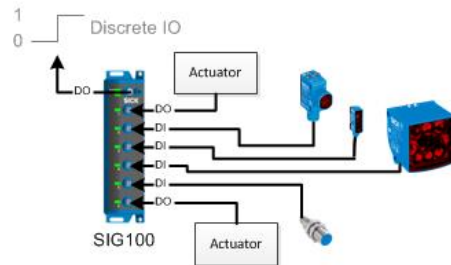

Figure 1: Stand alone system 1

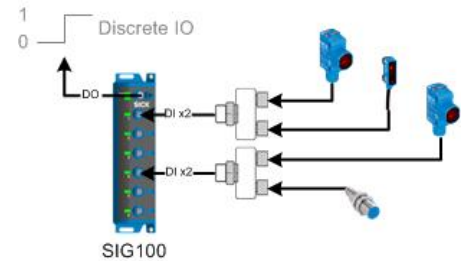

Figure 2: Stand alone system 2

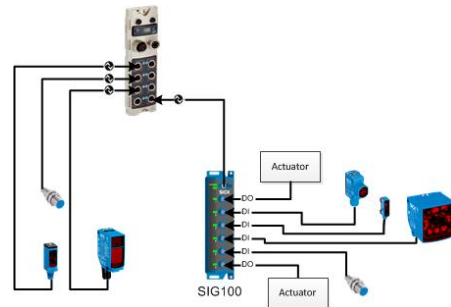

Figure 3: SIG100 as IO-Link Slave

If the product is used for any other purpose or modified in any way, any warranty claim against SICK AG shall become void.

3 Operating and status indicators

When Sensor Integration Gateway SIG100 is operating, the status of the connections are indicated visually by status LEDs. Using these status indicators, the operator can find out quickly and easily whether the SIG100 and all connected devices are working properly.

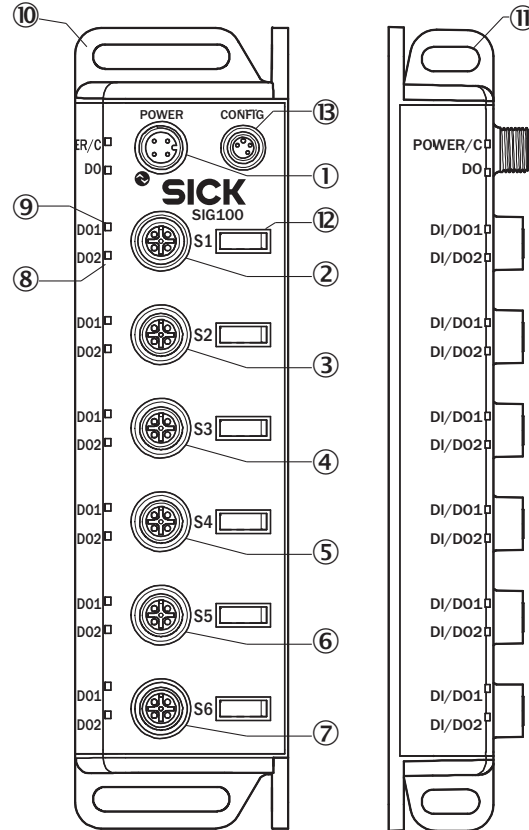

Figure 4: dimensional drawing

- ① IO-Link / Power in
- ② Port S1 for the connection of a standard inputs or standard outputs
- ③ Port S2 for the connection of a standard inputs or standard outputs
- ④ Port S3 for the connection of a standard inputs or standard outputs
- ⑤ Port S4 for the connection of a standard inputs or standard outputs
- ⑥ Port S5 for the connection of a standard inputs or standard outputs
- ⑦ Port S6 for the connection of a standard inputs or standard outputs
- ⑧ Port LED pin 2
- ⑨ Port LED pin 4
- ⑩ Mounting ears for front mounting
- ⑪ Mounting ears for side mounting
- ⑫ Marker tag pocket
- ⑬ USB configuration port (only for configuration and diagnosis)

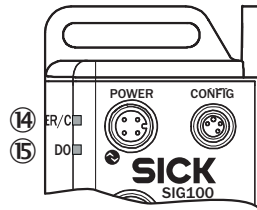

Table 2: Power/IO-Link Port LEDs

⑭	Green	Power Supply / IO-Link Activity
⑮	Amber	Q Output: off: logic editor output QL1 low (=0) or output not used. orange: logic editor output QL1 high (=1)

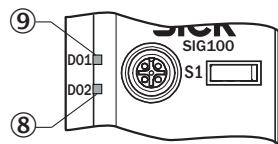

Table 3: I/O connector LEDs (Port S1-S6)

⑨	Amber	pin 4 is active
⑧	Amber	pin 2 is active

4 Transport and storage

4.1 Transport

For your own safety, please read and observe the following notes:



NOTE

Damage to the sensor due to improper transport.

- The device must be packaged for transport with protection against shock and moisture.
- Recommendation: Use the original packaging as it provides the best protection.
- Transport should be performed by specialist staff only.
- The utmost care and attention is required at all times during unloading and transportation on company premises.
- Note the symbols on the packaging.
- Do not remove packaging until immediately before you start mounting.

4.2 Transport inspection

Immediately upon receipt at the receiving work station, check the delivery for completeness and for any damage that may have occurred in transit. In the case of transit damage that is visible externally, proceed as follows:

- Do not accept the delivery or only do so conditionally.
- Note the scope of damage on the transport documents or on the transport company's delivery note.
- File a complaint.



NOTE

Complaints regarding defects should be filed as soon as these are detected. Damage claims are only valid before the applicable complaint deadlines.

4.3 Storage

Store the device under the following conditions:

- Recommendation: Use the original packaging.
- Do not store outdoors.
- Store in a dry area that is protected from dust.
- So that any residual damp can evaporate, do not package in airtight containers.
- Do not expose to any aggressive substances.
- Protect from sunlight.
- Avoid mechanical shocks.
- Storage temperature: [see "Technical data", page 46](#).
- Relative humidity: [see "Technical data", page 46](#).
- For storage periods of longer than 3 months, check the general condition of all components and packaging on a regular basis.

5 Mounting

The SIG100 is mounted with two screws, maximum M6, and two flat washers.
Note the maximum permissible tightening torque of 0.8 Nm.

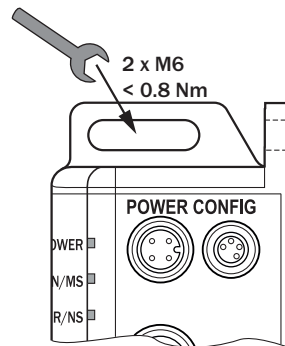

Figure 5: Mounting

6 Electrical installation

Establish a power supply connection (M12 A-coded connector) to the SIG100. Connect the desired devices (sensors/actuators) to the SIG100.

The sensors must be connected in a voltage-free state ($U_V = 0\text{ V}$). The following information must be observed, depending on the connection type:

The total current draw of the SIG100 must not exceed 4A.



NOTICE DAMAGE OF EQUIPMENT

Equipment damage due to incorrect supply voltage! Please note the instructions for electrical installation.

An incorrect supply voltage may result in damage to the equipment. Operation in short-circuit protected network max. 8 A.

Only apply voltage/switch on the voltage supply ($U_V > 0\text{ V}$) once all electrical connections have been established.

Female connectors that are not used must be sealed with blind caps so that the enclosure rating of IP 67 is assured.

The IO-Link output draws power via the sensor supply.

The digital input correspond to the input characteristic according to EN 61131-2, type 1 and type 3.

Explanation of the connection diagram.

DI = Digital input

DO = Digital output

n. c. = not connected

6.1 DC

DC: 10 ... 30 V DC, see "Technical data", page 46



NOTE

SIG100 is only made for the connection of PNP sensors and not for NPN sensors.

Table 4: Power Port, M12 A-coded

Pin	Signal	Description
1	+ (L+)	+ 24 V DC nominal
2	DO	configurable as a Standard Discrete Output
3	M	0 V
4	DO / C	configurable as IO-Link or standard output.

Table 5: USB Port (for configuration), M8



Pin	Signal	Description
1	+ (L+)	+ 5 V DC nominal
2	- Data	
3	M	0 V (logic ground)
4	+ Data	
		

Table 6: Port S1-S6

Pin	Signal	Description
1	+ (L+)	+ 24 V DC nominal
2	DI / DO	Configurable as Discrete Input or Discrete Output
3	M	0 V (logic ground)
4	DI / DO	Configurable as Discrete Input or Discrete Output
5	n. c.	
		

**NOTICE**

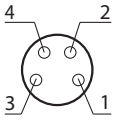
Each port (S1-S6) is limited to 50 mA. The power consumption of the device or devices must be checked before starting a new project.

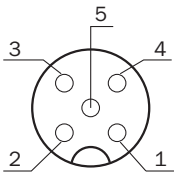
7 SIG100 configuration

The SIG100 can be configured with a personal computer (running Microsoft Windows operating system) via USB using the SOPAS Engineering Tool software.

The necessary cable (M8 - USB) can be ordered separately. The article number is 6051163.

The SOPAS Engineering Tool can be downloaded on www.sick.com.

Please install the latest SOPAS ET version (V2018.2 or higher).

After SOPAS ET has started, please install the SIG100 device driver (SDD). The SDD can be uploaded from the connected device or from sick.com. Please note, that on sick.com there are two different SDDs provided. One for the use with USB (→ SIG100 directly connected to a laptop/PC via USB cable e.g. 6051163) and an additional SDD for the use of SOPAS via IO-Link (with SiLink2 Master 1061790). Please make sure you are using SOPAS ET via USB with the right SDD file when you would like to use the logic editor. The IO-Link SDD does not support the logic editor.

7.1 Operation via SOPAS ET

The SOPAS Engineering Tool allows configuring the SIG100 with a personal computer running Microsoft Windows operating system.



NOTE

Please make sure that you are using the latest SOPAS ET Version (Version 2018.2 or higher).



NOTE

Please make sure you are using the interface oriented search (→ click on "search settings" and select "interface oriented search" and "USB").

7.1.1 SOPAS ET overview and standard functions on each page

SIG100 pages have the following common layout:

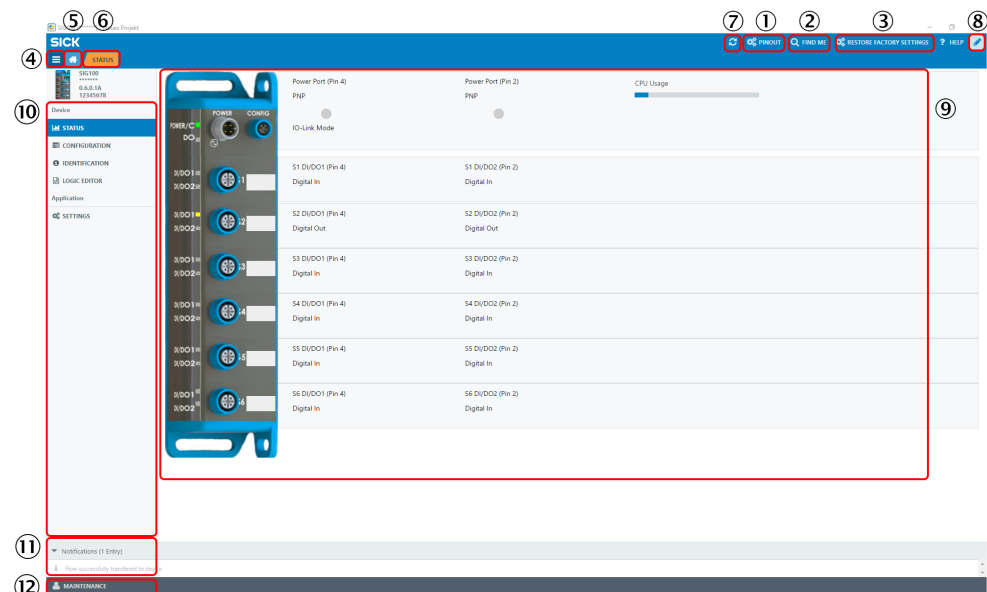



Figure 6: SOPAS ET layout

- ① PINOUT: Show process data
- ② FIND ME function
- ③ RESTORE FACTORY SETTINGS
- ④ Menu
- ⑤ Home
- ⑥ STATUS
- ⑦ Refresh page
- ⑧ Edit mode
- ⑨ Page contents
- ⑩ Page selection
- ⑪ Notifications
- ⑫ User mode (e. g. Maintenance)

The buttons located in the upper right portion of the interface provide global device configuration. These buttons will be present on every configuration page.

Table 7: Functions

<p>EDIT</p>  	<p>The EDIT button allows the settings on a given configuration page to be changed.</p> <p>The EDIT button will be highlighted light blue when activated. Pages that can be configured will be gray until the EDIT button is pressed.</p> <hr/> <p>NOTE</p> <ol style="list-style-type: none"> 1. Click on the button EDIT (on the upper right side) 2. Click on the button RUN (on the lower left side) 3. Change the user mode from RUN into MAINTENANCE 4. Insert the password "main" 5. Now you can change the settings
---	---

PINOUT: Show process data



The Pinout button provides the IO-Link process data structure and a visualization of the connected SIG100.

Process Data In: process data from SIG100 to the IO-Link master. It is 8 bytes long and lists the bit location and state of each input.

Process Data Out: process data from the PLC / from the IO-Link master to the SIG100. It is 2 bytes long and provides the combined output state from logic configuration for up to 16 outputs.

Process Data In

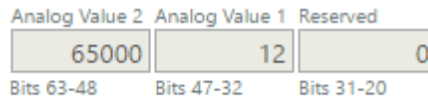
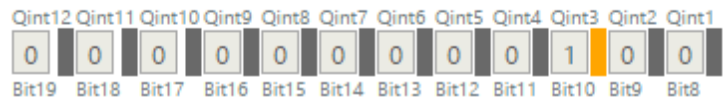
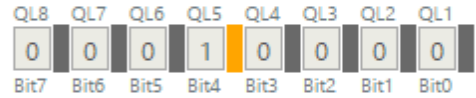

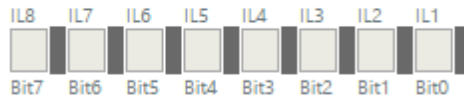

Process Data Out



Radix Selection

dec
 bin
 hex

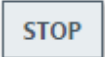

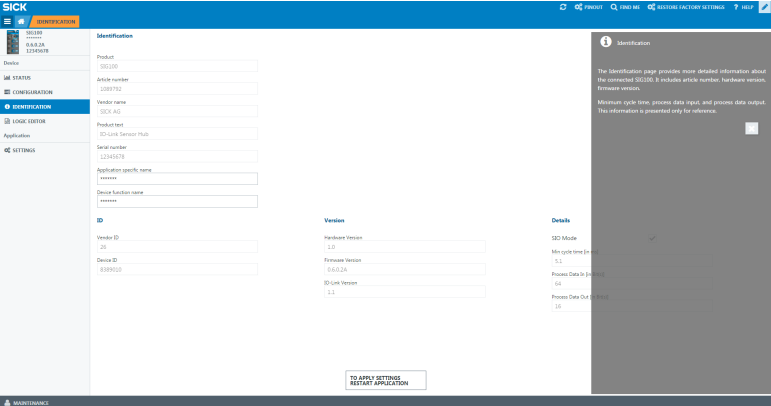
<p>FIND ME function</p> 	<p>Clicking on this button the "DO" LED next to the power port of the SIG100 will flash with 1Hz until the button is clicked again. The function is intended to allow you to identify the device when already mounted to an application.</p> <hr/> <p>NOTE</p> <p>While FIND ME is active, no other interface navigation is possible until pressing the STOP button on the dialogue box.</p> <div style="text-align: center;"> <p>Information</p> <p>FindMe active, LEDs of the device should flash</p>  </div>
<p>RESTORE FACTORY SETTINGS</p> 	<p>Clicking on this button the SIG100 will reset all settings to the factory defaults. As a factory default, all ports are configured as digital inputs. The selection of the RESTOR FACTORY SETTINGS has to be double checked in a "Confirm Action" box.</p> <p>Any setting currently stored in the device is overwritten if "OK" is clicked. After clicking "OK", a "Success" box will appear indicating that the connected SIG100 has been restored to factory default settings.</p> <hr/> <p>NOTE</p> <p>While both of the dialogues boxes are active, no other interface navigation is possible.</p> <hr/> <p>NOTE</p> <p>The Restore Factory Defaults button works from any of the configuration pages.</p>
<p>HELP</p> 	<p>The HELP button toggles a help screen on the right side of the user interface for each configuration page. This provides more information about the SIG100 as it relates to each page.</p> <hr/> <p>NOTE</p> <p>The HELP screen will stay open while toggling different configuration pages on the configuration tree.</p> <div style="border: 1px solid #ccc; padding: 5px; margin-top: 10px;">  </div>

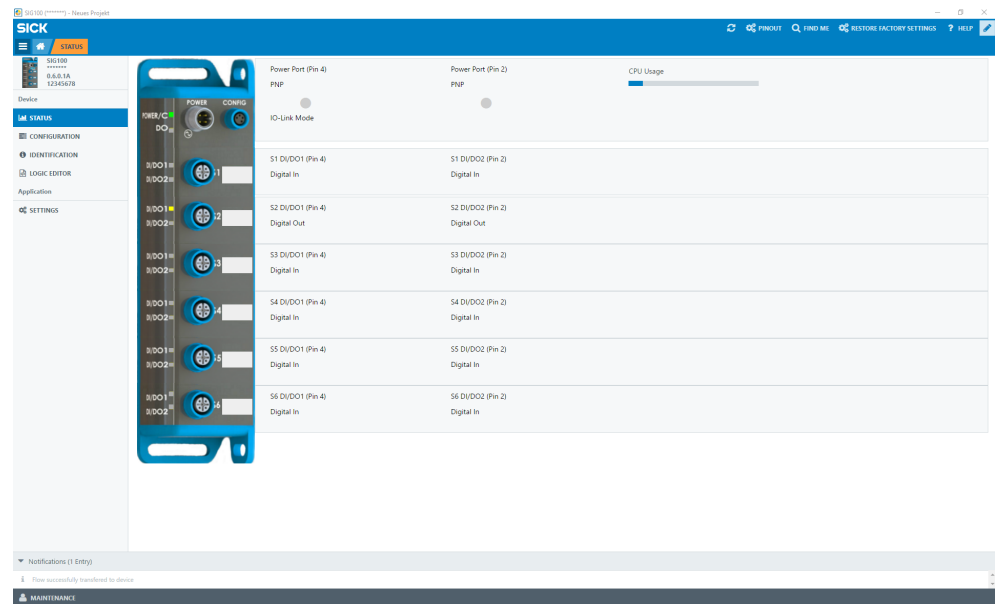

Figure 7: Status page

The page contents show the configuration of each port for pin 2 and pin 4 and the current input or output level. The LEDs on the SIG100 picture will change state based on the actual state of the connected device. The ports will reflect the input or output setting established on the Configuration page. The port labels will update to reflect the user defined port labels from the Configuration page.

The Power port (pin 2) visualizes the output "DO2" of the Logic Editor and shows the current status. The gray circle changes from gray to green depending on the output level.

The Power port (pin 4) visualizes the Output "DO1" of the Logic Editor and shows the current status. The gray circle changes from gray to green depending on the output level. This is not configurable.

In the picture on the left side the "Power/C" LED is always green to visualize that the SIG100 is powered on.

The "DO" LED next to the Power port is visualizing the "QL1" of the Logic Editor. This is not configurable and can not be changed.

7.1.3 Configuration page



The configuration page of SIG100 allows changing of any setting of each M12 port. The page is separated into sub-pages that can be selected by clicking on one of the tabs on top of the page.

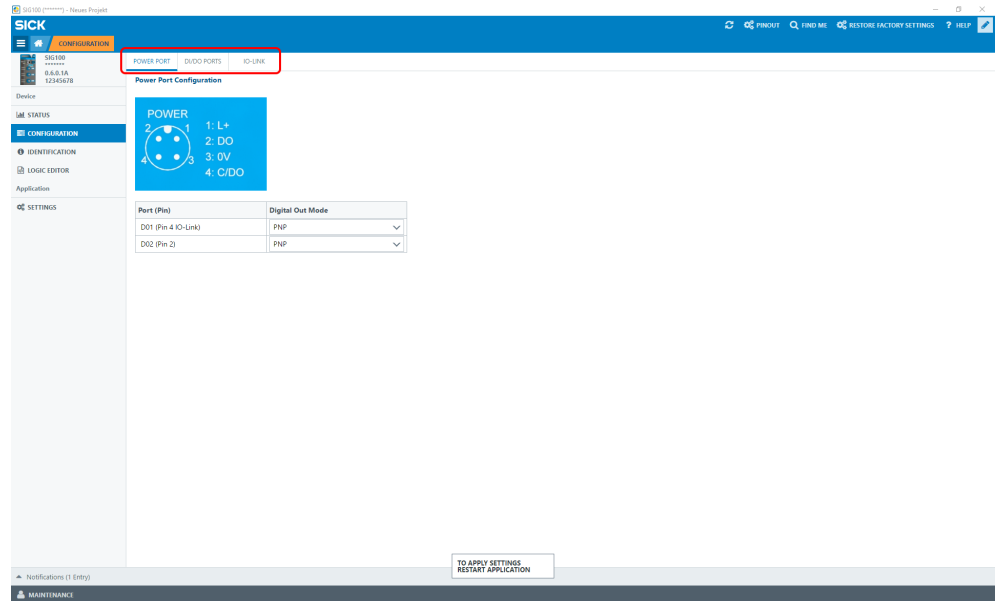

Figure 8: Configuration page

Power port

The Power port tab allows configuring settings of the Power port.

It's possible to configure the outputs on pin 2 and pin 4 of the Power port as PNP, Push-Pull or OFF.

To edit the setting, login as Maintenance and click the edit button. Select the drop down box and choose the desired output setting. A PNP output will provide the SIG100 supply voltage to the load. The Push-Pull output will provide either SIG100 supply voltage or 0 V depending on the load requirements.

DI/DO ports

The DI/DO ports tab allows configuring settings of the DI/DO ports.

The DI/DO page allows you to change pin 2 and pin 4 on each of the six M12 ports (S1-S6). They can be set as either input or an output. S number refers to the port number with S1 being the first "top" port and S6 being the very bottom port. DI/DO1 will always refer to pin 4 and DI/DO2 will always refer to pin 2.

IO-Link

The IO-Link tab allows to configure the process data out mode. This process data out mode (from IO-Link Master to SIG100) can be either Digital (having 16 Logic Editor inputs --> IL1...IL16) or Analog (having 1 Analog input).

This process data out structure will be displayed also on the PINOUT view and in the logic editor. Depending on what was chosen in this IO-Link tab, the logic editor and the PINOUT overview will be adapted automatically.



NOTE

The process data out belongs to the 2 Bytes of process data which are coming from PLC/IO-Link Master to the SIG100. Be aware this configuration has no impact on the process data in (from SIG100 to the IO-Link Master/PLC).

7.1.4 Identification page



The Identification page of SIG100 shows the device identification data. It is possible to define an application and device specific name.

7.1.5 Logic Editor page



The Logic Editor page of SIG100 allows user-defined logic functions to be applied to the available input signals and transmit the results on various output signals, by dragging and dropping logic gates and connection lines.

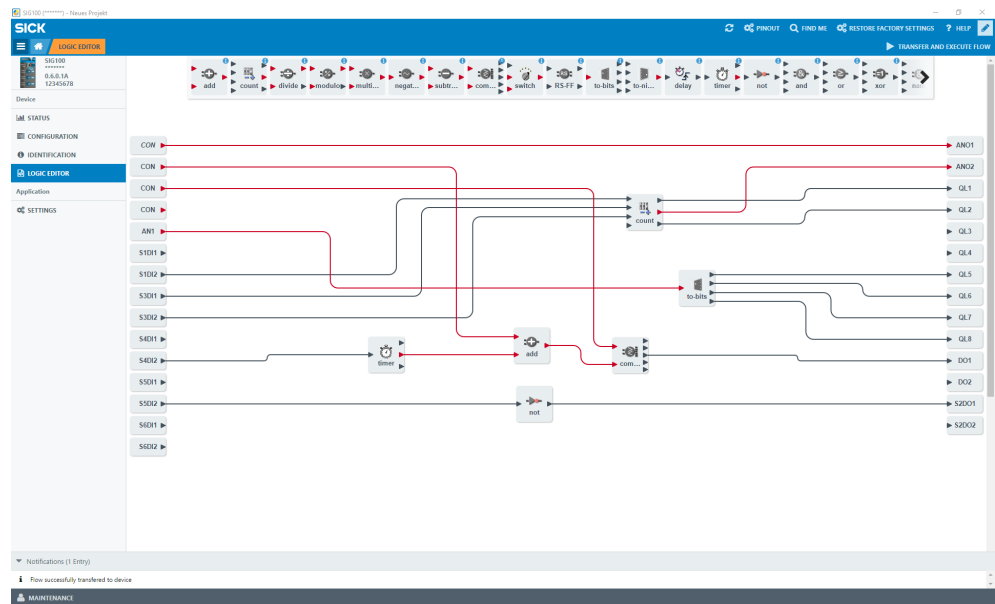

The left side of the screen lists all configured inputs. The upper middle bar has the available logic gates that can be dragged down into the workspace. And listed on the right side are the configured outputs.



NOTE

Note that the screen is gray until the user clicks the “Edit” button, see ["SOPAS ET overview and standard functions on each page"](#), page 12.

To establish new logic functions you need to log in as **maintenance**, see ["Editing Mode"](#), page 25.

Creating a logic system

- 1 Select the required logic gates: click and drag them into the workspace.
- NOTE**
If a logic block incorrectly selected, or needs to be removed, click on it and drag it back up to the selection bar. A garbage bin will appear to remove the selected logic gate from the workspace.

2 Make connections from the inputs to the logic gates: click on the desired input, click again and hold on the arrow. A connection line will be created. Note that you can then drag the line to a desired input logic gate.
 Getting close in proximity, the logic gate inputs will expand to accept the connection line. Once the connection is made, the bend location (if the connection is bent), the logic gate location, and the window size can be moved. The connection will automatically scale. An incorrect connection can be removed by clicking and holding on the connection line: the garbage bin will appear at the top-center of the interface.
 Some logic blocks require minimum two input signals.
 Please be aware that inputs always need to be occupied from top to down (e. g. in case of two inputs use A+B and not A+D).
 The inputs have a red halo when making connections to indicate that the connection is still required in this space. The two inputs C and D will only be active in the logic truth table if a connection is made.

i **NOTE**
 Green input arrows and green text: a connection is possible
 If connection is not possible, the text will have red color and it is not possible to drag a connection to the input.

i **NOTE**
 Some inputs and logic gates have a small gear indicating that some additional settings are possible. Clicking on the gear will open the additional settings dialogue box and allows for additional configuration (e. g. delay time).

3 Close the setup by using the Transfer and Execute Flow button: the new logic configuration is transferred to the connected SIG100.



i **NOTE**
 An error will appear if there are any improper or missing connections. The notification area will indicate a successful transfer.

7.1.6 Settings



The following settings are possible:

Setting	Possible values
Language	english / german
Display mode	phone / tablet / desktop

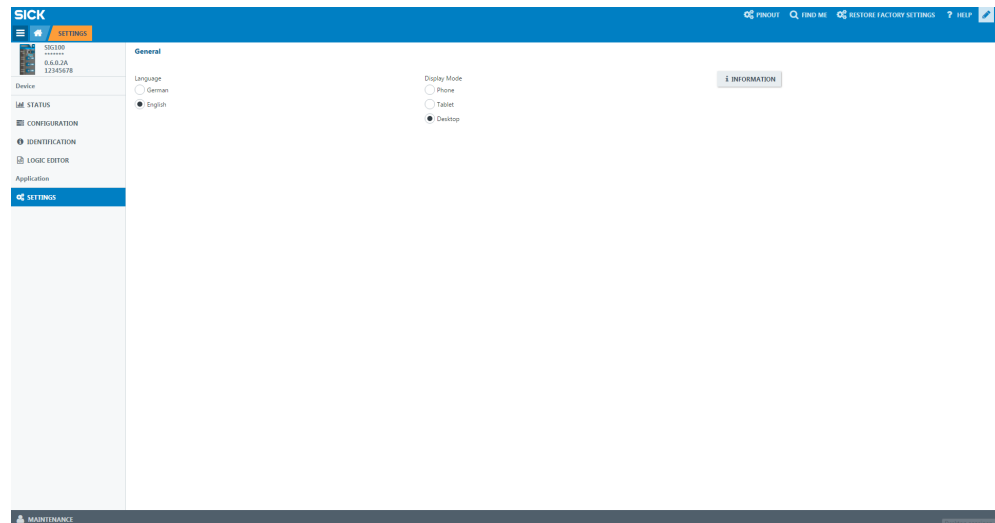

The information button provides more details about the interface software release.

7.2 Operation via IO-Link

The SIG100 can exchange process data and parameters via IO-Link. To do so, the IO-Link Sensor Hub (SIG100) is connected to a suitable IO-Link Master.

The IO-Link interface of the SIG100 has the following properties:

Table 8: IO-Link properties

Characteristic	Values
Digital inputs	max. 12 x PNP type 1
Digital outputs	max. 12 x PNP
IO-Link specification	V 1.1
IO-Link port class	port class A
Minimum cycle time	5.1 ms
Transmission rate	COM2 (38.4 kBaud)
Process data width	8 Byte Process Data In (from SIG100 to IO-Link Master) 2 Byte Process Data Out (from IO-Link Master to SIG100)
Parameter server (Data Storage)	Yes
Initialization time after switch-on	< 8 s
Min. time for a logic from one sensor port (e.g. S1D11) to another sensor port (e.g. S2D02)	1 ms (max. switching frequency: 200 Hz)
Min. time for 10 connected logic blocks (e.g. NOT gates)	2 ms
Min. time for 20 logic blocks (e.g. NOT gates)	3 ms



NOTE

The total cycle time for SIG100 depends on the amount and type of used logic blocks and is always application specific.



NOTE

Please be aware that Integer functions are significant slower than Boolean functions.



NOTE

There is no event indicating a jitter or overload condition. You can test your configured logic by running the application and checking if the „CPU load bar” on the Status page in SOPAS is maxed out.

7.2.1 Process data

The Sensor Integration Gateway SIG100 uses both Process Data In (data from IO-Link Sensor Hub to IO-Link Master) and Process Data Out (data from IO-Link Master to IO-Link Sensor Hub).

Process Data In contains the following data:

- Unprocessed signals on the DI/DO ports
 - DI/DO port pin configured as “Digital Input”: Current logic level
 - DI/DO port pin configured as “Digital Output”: Monitoring of output level
- Processed digital output signals of the Logic Editor
- Processed integer output values of the Logic Editor



NOTE

The unprocessed signals are always available on Process Data In regardless of programmed Logic Editor application.



NOTE

Logic Editor values (e.g. Counter value) will be lost after a power cycle.

7.2.1.1 Process data structure

Table 9: PD IN SIG100 -> IO-Link Master

Byte	Bit	Value	Signal input / output	Data type
0 ... 1	Bit 63 ... 48	AV2	Analog value 2	UInteger 16
2 ... 3	Bit 47 ... 32	AV1	Analog value 1	UInteger 16
4	Bit 31	Reserved		
	Bit 30	Reserved		
	Bit 29	Reserved		
	Bit 28	Reserved		
	Bit 27	Reserved		
	Bit 26	Reserved		
	Bit 25	Reserved		
5	Bit 24	Reserved		
	Bit 23	Reserved		
	Bit 22	Reserved		
	Bit 21	Reserved		
	Bit 20	Reserved		
	Bit 19	Qint 12	Port 6 pin 2 (input or output)	Boolean
	Bit 18	Qint 11	Port 6 pin 4 (input or output)	Boolean
	Bit 17	Qint 10	Port 5 pin 2 (input or output)	Boolean
Bit 16	Qint 9	Port 5 pin 4 (input or output)	Boolean	

Byte	Bit	Value	Signal input / output	Data type
6	Bit 15	Qint 8	Port 4 pin 2 (input or output)	Boolean
	Bit 14	Qint 7	Port 4 pin 4 (input or output)	Boolean
	Bit 13	Qint 6	Port 3 pin 2 (input or output)	Boolean
	Bit 12	Qint 5	Port 3 pin 4 (input or output)	Boolean
	Bit 11	Qint 4	Port 2 pin 2 (input or output)	Boolean
	Bit 10	Qint 3	Port 2 pin 4 (input or output)	Boolean
	Bit 9	Qint 2	Port 1 pin 2 (input or output)	Boolean
	Bit 8	Qint 1	Port 1 pin 4 (input or output)	Boolean
7	Bit 7	QL8	Logic Editor output signal	Boolean
	Bit 6	QL7	Logic Editor output signal	Boolean
	Bit 5	QL6	Logic Editor output signal	Boolean
	Bit 4	QL5	Logic Editor output signal	Boolean
	Bit 3	QL4	Logic Editor output signal	Boolean
	Bit 2	QL3	Logic Editor output signal	Boolean
	Bit 1	QL2	Logic Editor output signal	Boolean
	Bit 0	QL1	Logic Editor output signal	Boolean

The following two data formats are available for Process Data out and are selected via the user interface (see "Process data Select", page 59).

Table 10: PD OUT IO-Link Master -> SIG100 / Mode 1

	Bit	Value	Signal input / output	Data type
0	Bit 15	IL16	Logic Editor input	Boolean
	Bit 14	IL15	Logic Editor input	Boolean
	Bit 13	IL14	Logic Editor input	Boolean
	Bit 12	IL13	Logic Editor input	Boolean
	Bit 11	IL12	Logic Editor input	Boolean
	Bit 10	IL11	Logic Editor input	Boolean
	Bit 9	IL10	Logic Editor input	Boolean
	Bit 8	IL9	Logic Editor input	Boolean
1	Bit 7	IL8	Logic Editor input	Boolean
	Bit 6	IL7	Logic Editor input	Boolean
	Bit 5	IL6	Logic Editor input	Boolean
	Bit 4	IL5	Logic Editor input	Boolean
	Bit 3	IL4	Logic Editor input	Boolean
	Bit 2	IL3	Logic Editor input	Boolean
	Bit 1	IL2	Logic Editor input	Boolean
	Bit 0	IL1	Logic Editor input	Boolean

Table 11: PD OUT IO-Link Master -> SIG100 / Mode 2

Byte	Bit	Value	Signal input / output	Data type
0 ... 1	Bit 0 ... 15	AV1	Analog value 1	UInteger 16

7.2.1.2 Bit-Mapping of the ports (S1-S6)

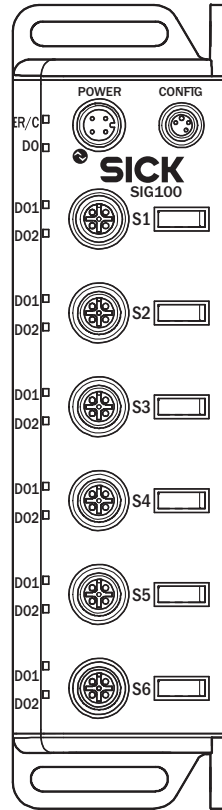

Bit 0	...
.	
.	
.	
Bit 8 = S1	pin 4
Bit 9 = S1	pin 2
Bit 10 = S2	pin 4
Bit 11 = S2	pin 2
Bit 12 = S3	pin 4
Bit 13 = S3	pin 2
Bit 14 = S4	pin 4
Bit 15 = S4	pin 2
Bit 16 = S5	pin 4
Bit 17 = S5	pin 2
Bit 18 = S6	pin 4
Bit 19 = S6	pin 2
.	
.	
.	
Bit 63	...

7.2.2 Device data

In addition to the process data, device data (parameters, identification data, and diagnostic information) can be transmitted to and from the Sensor Integration Gateway SIG100. To use this function, a specific device description file (IODD) can be used together with an IO-Link Master.

A download package including the IODD file and supplementary documentation for SIG100 is available at www.sick.com.



NOTE

Not all functions available through SOPAS ET are also available through IO-Link. This mainly concerns the use of the Logic Editor.

7.3 Device functions

All available configuration functions are explained in the annex, see "Technical Information", page 49. For each function the available interface is listed (i.e. SOPAS ET and/or IO-Link).

7.4 Logic Editor

The Logic Editor of SIG100 is a key function allowing you to realize arbitrary applications with connected sensors or actuators.

**NOTE**

The Logic Editor configuration is not accessible via IO-Link. However, IO-Link process data (Process Data In or Process Data Out) can be used as output or input value for the Logic Editor.

7.4.1 Editing Mode

Figure 9: Editing Mode

1. To start your configuration change the operating mode from **Run** to **Maintenance** because the **Run** mode is a read only mode.
2. Click on **Run** on the bottom left side and select **Maintenance** in the drop-down menu.
3. The login password for the maintenance mode is: **main**
4. Click on **Login** to select the Maintenance Mode.



- 5.

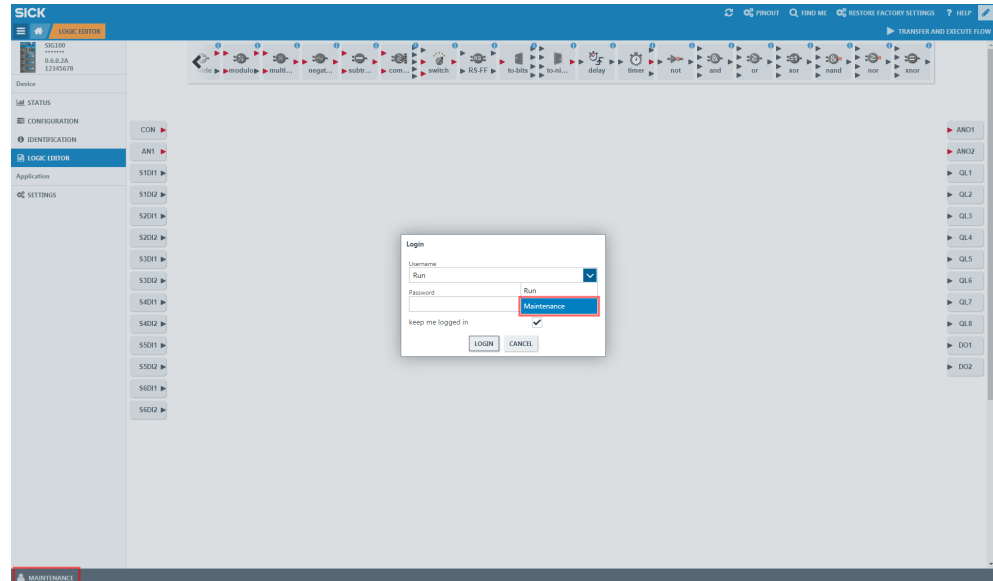
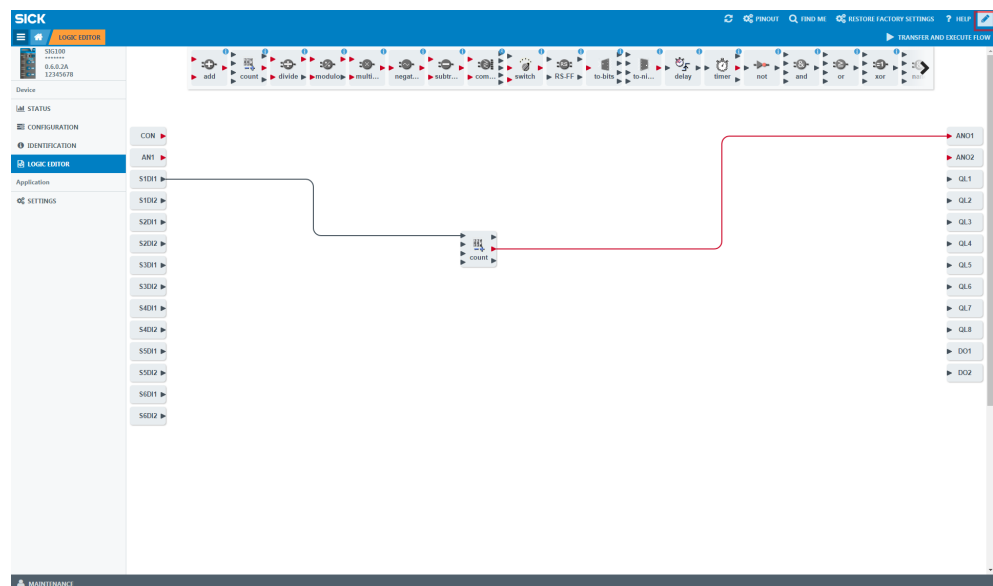

To start with a new configuration, click on **EDIT** in the upper right corner.

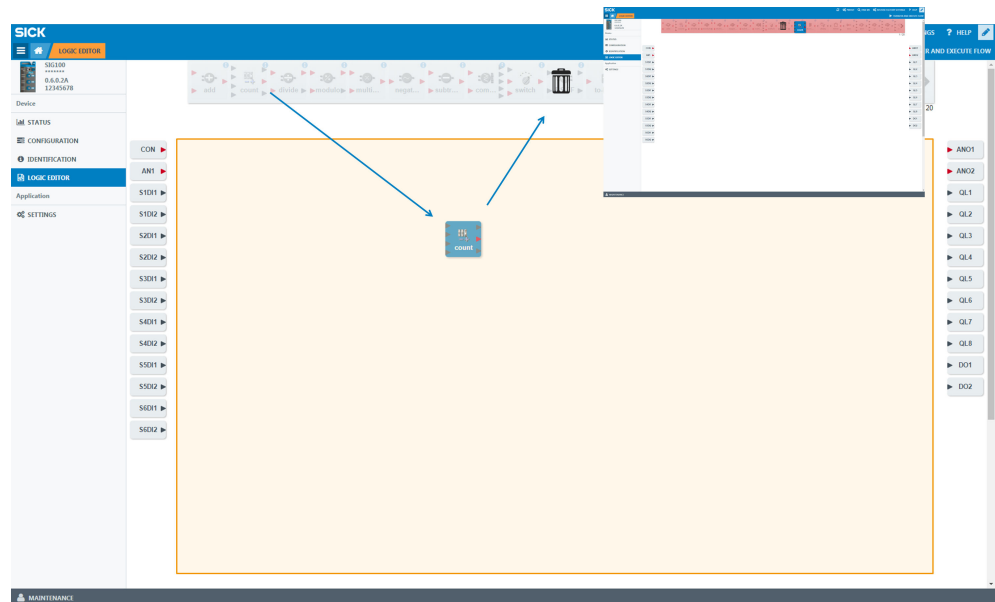

Figure 12: Logic blocks

- Use drag & drop to select the desired logic block and put it into the workspace.
- To delete logic blocks put them back in the upper area via drag & drop.
- The maximum amount of logic blocks which can be used in the logic editor in parallel is 20 blocks.

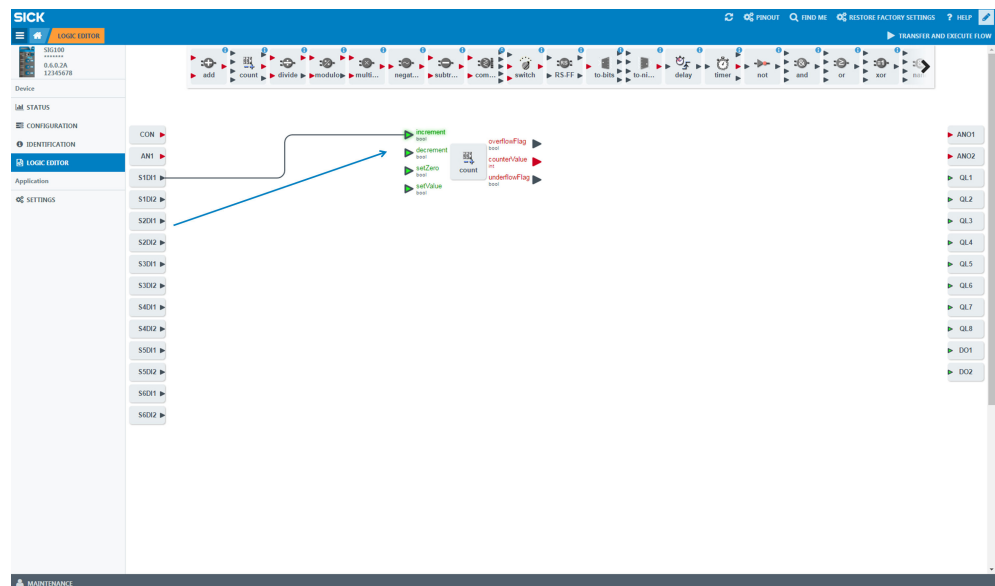

Figure 13: Connections

- Connect your logic blocks with drag & drop with the inputs and outputs. Click first on the triangle on the input, hold the line and connect it to a triangle of the logic block.
- Please note to use always the upper inputs first, starting at A, then B, then C. In case you use only two inputs please use always the top two inputs A+B and not e.g. B+D.
- Please note whether the values are Integer or Boolean it is only possible to connect Integer with Integer and Boolean with Boolean. Boolean values have a black triangle. Integer values can be easily identified with a red triangle.

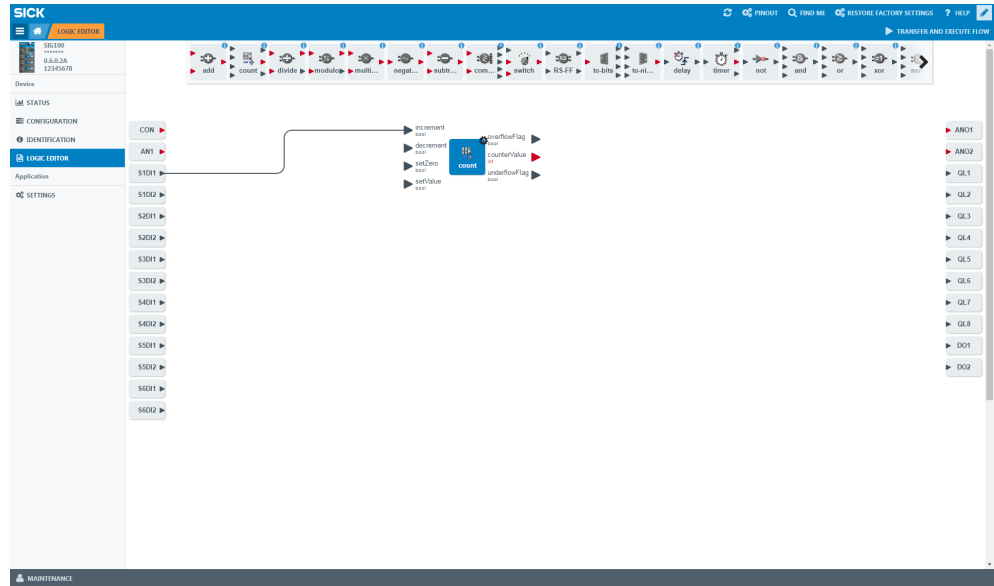

Figure 14: Possible connections

By clicking on logic block you get information about the possible connections to this individual block.

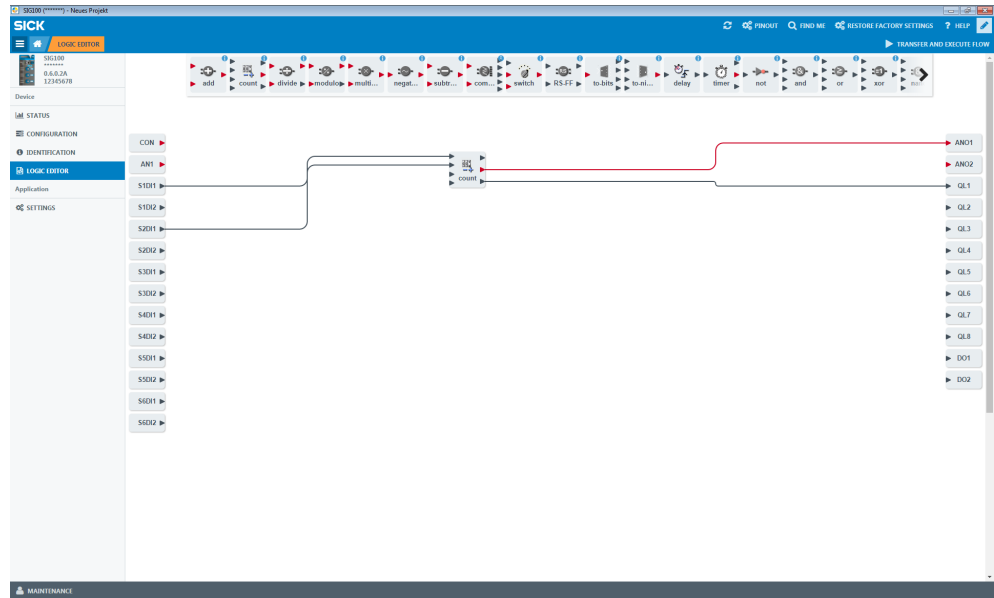
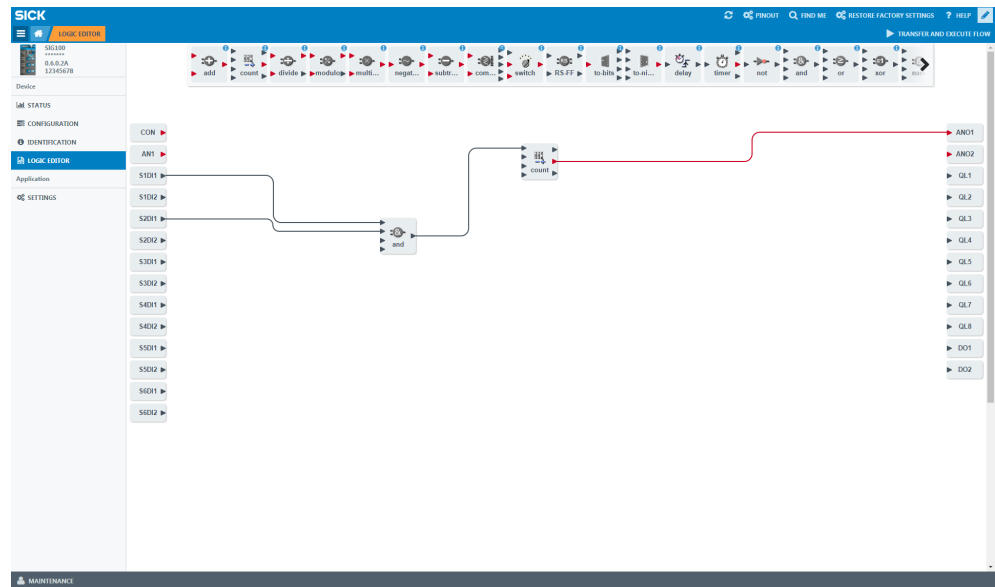
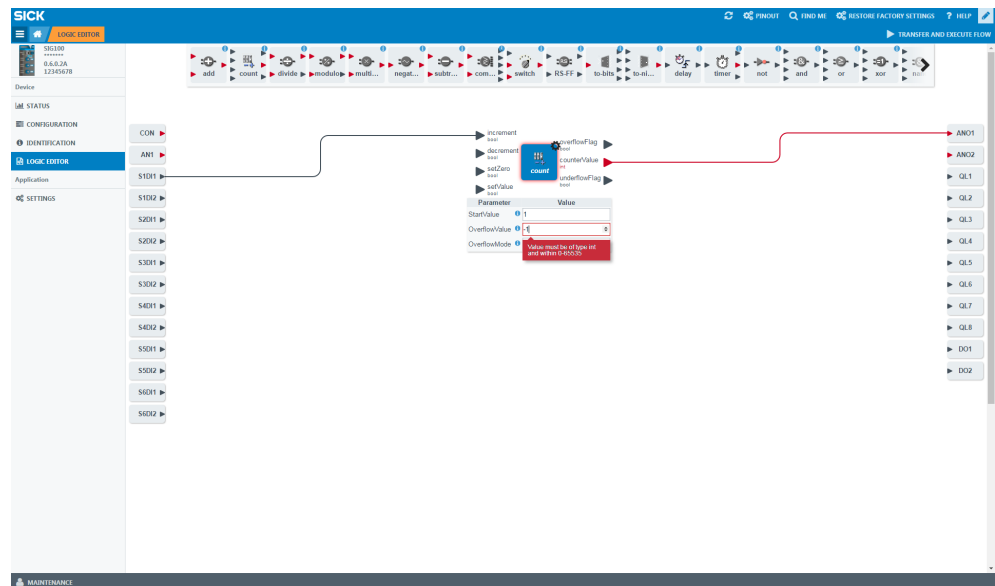



Figure 15: Several inputs and outputs

It is possible to connect several inputs and outputs with logic blocks.



- A combination of logic blocks is possible as well.
- Pay attention to inputs and outputs (Integer/Boolean).



- Click on **Settings**  (=gear) to configure parameters and values of the logic block or input/output variable.
- Please note that only integer values are allowed (0-65535).



NOTE
Not all logic blocks are adjustable.

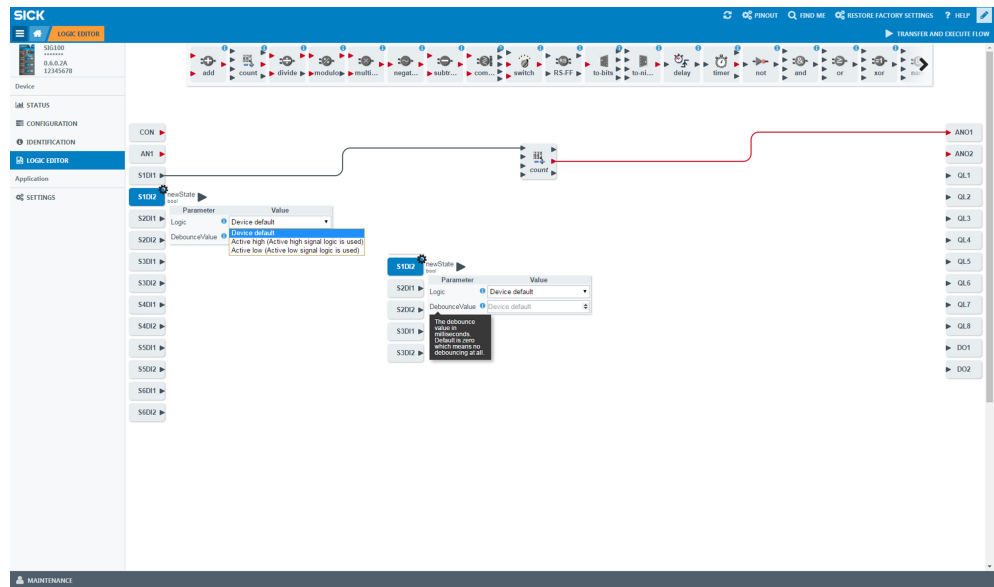

Figure 16: Configuration of digital inputs

- A configuration of your digital inputs is also possible.
- For configuration click on the selected port first and on the gear second to set **Logic** and **DebounceValue**.
- Use your mouse to get more information about **Logic** or **DebounceValue**.

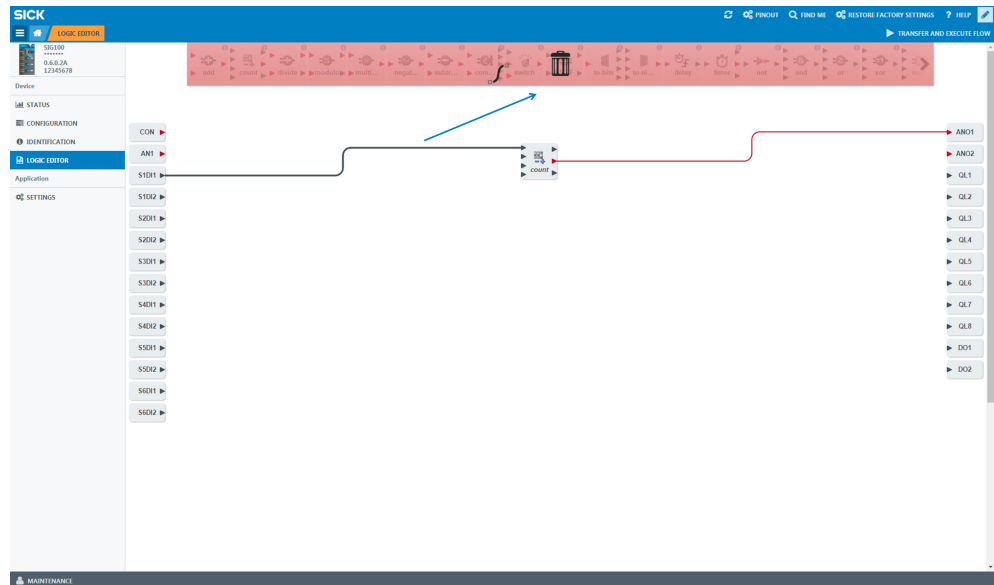

Figure 17: Delete connections

To remove a connection click on your desired connection and put it in into the garbage bin on the upper area via drag & drop.

7.4.3 Download new Logic to the Device

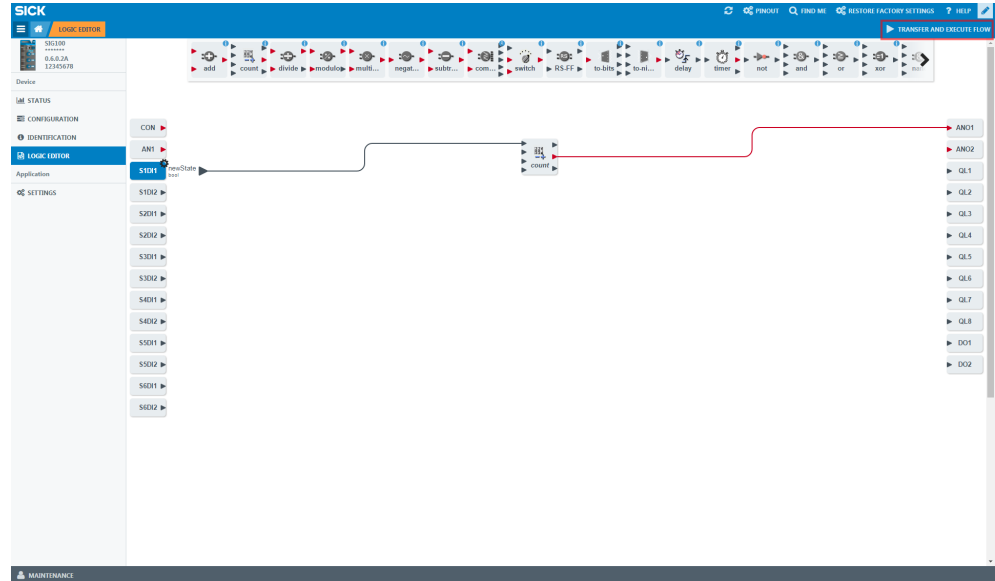

Figure 18: Transfer and execute flow

Press **TRANSFER AND EXECUTE FLOW** to synchronize your workflow with your device. All changes you made without pressing this button will be lost and are not downloaded to your SIG100 device.

7.4.4 Explanation of Inputs, Outputs and Logic Blocks

Digital Inputs



Figure 19: Digital inputs

The Logic Editor shall offer each connected DI signal (pin 2 or pin 4 of each DIO port) as a Boolean signal input.

The Logic Editor shall foresee the following configuration parameters for Digital inputs block:

Logic inverted/not inverted

Debounce filter (with number of consecutive stable samplings configurable from 1... 100)

The Logic Editor shall label each DI signal according to the following scheme: SxDI1 (for port x=1...6 pin 4 as input), SxDI2 (for port x=1...6 pin 2 as input).

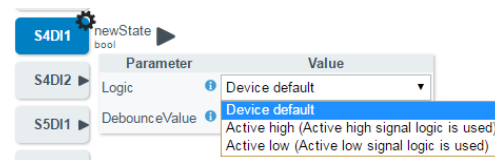

The individual digital inputs on port S1-S6 can be configured either as active high or active low when clicking on the gear symbol next to the digital output block.

Furthermore, a debounce value (in ms) can be configured.

Min: 1 ms

Max: no limit

Digital Outputs



Figure 20: Digital outputs

The Logic Editor enables to use each connected DO signal as a Boolean signal output. This includes the signal on pin 2 and pin 4 of each DI/DO port (S1-S6).



NOTE

The power port is named in the logic editor with DO1 (pin 4) and DO2 (pin 2).

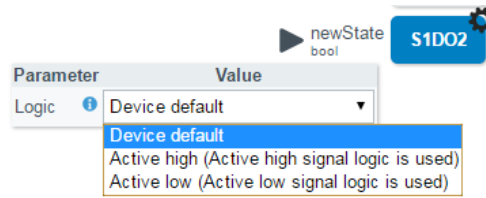

The individual digital outputs on port S1-S6 can be configured either as active high or active low when clicking on the gear symbol next to the digital output block.



NOTE

If IO-Link pin 4 changes from SIO mode to IO-Link mode the signal output shall be deactivated (and vice versa).

The Logic Editor shall label each DO signal according to the following scheme: SxDO1 (for port x=1...6 pin 4 as output), SxDO2 (for port x=1...6 pin 2 as output), DO1 (for power port pin 4 in SIO mode), DO2 (for power port pin 2).

Analog Inputs

The user can select between two process data Out mode.

Either:

1

Digital – For the use of 16 logic editor inputs (Boolean, IL1- IL16)

2

or Analog – for the use of one Analog value (1 Byte, Integer, AN1)



Constant

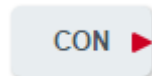

It is possible to calculate within the logic editor with a constant value. This value can be set to every number 0-65535. It is possible to use multiple constant values. A second constant value will automatically appear on the input side as soon as the first constant value is used in the logic.

Analog Outputs

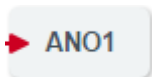

There are 2 Byte for analogue values reserved within the 8 Byte process data IN. This analog value can be used to e.g. easily transmit a counter value to the PLC.

Power



D01 belongs to the Power Port pin 4. D02 belongs to the Power Port pin 2. Both outputs can be used in the logic editor.

Logic Editor Outputs

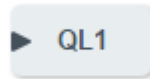

Within the process data IN there are 8 Bits reserved for logic editor outputs (QL1-QL8). The DO LED beside the power port is mapped to QL1 and visualizes this output.



NOTE



QL1-QL8 are Boolean outputs.

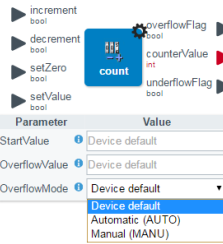
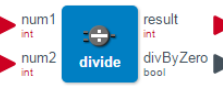

Logics

Table 12: Logic blocks

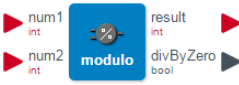

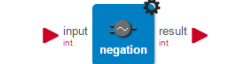
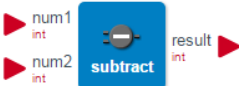
	Description	Addition of the two input values.
	Number of inputs	2
	Input data type	Integer
	Input description	num1: first input value num2: second input value
	Number of outputs	1
	Output data type	Output 1 (“+“): Identical to input data type
	Output description	result: result after addition of the two input values
	Settings	no settings available

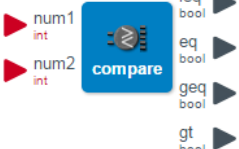
 <table border="1" data-bbox="167 283 391 420"> <thead> <tr> <th>Parameter</th> <th>Value</th> </tr> </thead> <tbody> <tr> <td>StartValue</td> <td>Device default</td> </tr> <tr> <td>OverflowValue</td> <td>Device default</td> </tr> <tr> <td>OverflowMode</td> <td>Device default</td> </tr> <tr> <td></td> <td>Automatic (AUTO)</td> </tr> <tr> <td></td> <td>Manual (MANU)</td> </tr> </tbody> </table>	Parameter	Value	StartValue	Device default	OverflowValue	Device default	OverflowMode	Device default		Automatic (AUTO)		Manual (MANU)	<p>Description</p> <p>Event counter for digital signals. Maximum switching frequency (e. g. for a NOT gate): 200 Hz Maximum switching frequency for the Counter: 90 Hz</p> <p>Number of inputs</p> <p>Input data type</p> <p>Input 1 ("Up"): 1-bit Input 2 ("Down"): 1-bit Input 3 ("Reset to 0"): 1-bit Input 4 ("Set to start value"): 1-bit</p> <p>Input description</p> <p>increment: value will be counted up decrement: value will be counted down setZero: set counter to zero setValue: set counter to StartValue</p> <p>Number of outputs</p> <p>Output data type</p> <p>Output 1 ("Overflow"): 1-bit Output 2 ("Counter value"): 16-bit Output 3 ("Underflow"): 1-bit</p> <p>Output description</p> <p>overflowFlag: bit is set if the count exceeds the overflow value counterValue: current counter value. Counter values are NOT saved through a power cycle. underflowFlag: flag is set when the value is below the overflow value. The default OverflowValue is 65535</p> <p>Settings</p> <p>StartValue: Counter value which will be set when the setValue is triggered (Default 0) OverflowValue: Maximum value of counter output (Default 65535) OverflowMode: Behavior of the counter value in case of an unteror overflow AUTO: After reaching the overflowvalue, the counter will be automatically reset to the defined start value MANU: When reaching the overflowvalue, the counter value can only be reset manually by the setZero or setValue signal Additional information: If the max counter value (overflow value) is reached then the overflow output is set high. But there is a difference between the automatic and manual mode. The automatic mode the value will be set to 0 on next rising edge of the increment input and of course the counter value can be changed by the setZero or setValue input. In the manual mode, the countervalue will stay on the overflowvalue until a rising edge on the decrement, setZero or setValue input is detected. The Default value for the counter start is 0 but can be set to any value within the range (16 bit).</p>	<p>Event counter for digital signals. Maximum switching frequency (e. g. for a NOT gate): 200 Hz Maximum switching frequency for the Counter: 90 Hz</p> <p>4</p> <p>Input 1 ("Up"): 1-bit Input 2 ("Down"): 1-bit Input 3 ("Reset to 0"): 1-bit Input 4 ("Set to start value"): 1-bit</p> <p>increment: value will be counted up decrement: value will be counted down setZero: set counter to zero setValue: set counter to StartValue</p> <p>3</p> <p>Output 1 ("Overflow"): 1-bit Output 2 ("Counter value"): 16-bit Output 3 ("Underflow"): 1-bit</p> <p>overflowFlag: bit is set if the count exceeds the overflow value counterValue: current counter value. Counter values are NOT saved through a power cycle. underflowFlag: flag is set when the value is below the overflow value. The default OverflowValue is 65535</p> <p>StartValue: Counter value which will be set when the setValue is triggered (Default 0) OverflowValue: Maximum value of counter output (Default 65535) OverflowMode: Behavior of the counter value in case of an unteror overflow AUTO: After reaching the overflowvalue, the counter will be automatically reset to the defined start value MANU: When reaching the overflowvalue, the counter value can only be reset manually by the setZero or setValue signal Additional information: If the max counter value (overflow value) is reached then the overflow output is set high. But there is a difference between the automatic and manual mode. The automatic mode the value will be set to 0 on next rising edge of the increment input and of course the counter value can be changed by the setZero or setValue input. In the manual mode, the countervalue will stay on the overflowvalue until a rising edge on the decrement, setZero or setValue input is detected. The Default value for the counter start is 0 but can be set to any value within the range (16 bit).</p>
Parameter	Value													
StartValue	Device default													
OverflowValue	Device default													
OverflowMode	Device default													
	Automatic (AUTO)													
	Manual (MANU)													
	<p>Description</p> <p>Division between the two input values.</p> <p>Number of inputs</p> <p>Input data type</p> <p>Integer</p> <p>Input description</p> <p>num1: first input value num2: second input value</p> <p>Number of outputs</p> <p>Output data type</p> <p>Output 1 ("/"): Identical to input data type Output 2 ("/0"): 1-bit</p> <p>Output description</p> <p>result: Result after dividing the two input values divByZero: When dividing by 0 (not possible) this output is set</p> <p>Settings</p> <p>No settings available</p>	<p>Division between the two input values.</p> <p>2</p> <p>Integer</p> <p>num1: first input value num2: second input value</p> <p>2</p> <p>Output 1 ("/"): Identical to input data type Output 2 ("/0"): 1-bit</p> <p>result: Result after dividing the two input values divByZero: When dividing by 0 (not possible) this output is set</p> <p>No settings available</p>												

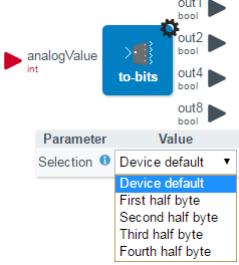

	Description	Modulo operation between the two input values.										
	Number of inputs	2										
	Input data type	Integer										
	Input description	num1: first input value num2: second input value										
	Number of outputs	2										
	Output data type	Output 1 ("/"): Identical to input data type Output 2 ("/0"): 1-bit										
	Output description	result: Result with rest after dividing the two input values divByZero: When dividing by 0 (not possible) this output is set										
Settings	No settings available											
	Description	Multiplication between the two input values.										
	Number of inputs	2										
	Input data type	Integer										
	Input description	num1: first input value num2: second input value										
	Number of outputs	1										
	Output data type	Output 1 ("x"): Identical to input data type										
	Output description	result: Result after multiplying the two input values										
Settings	No settings available											
 <table border="1" data-bbox="159 1039 399 1134"> <thead> <tr> <th>Parameter</th> <th>Value</th> </tr> </thead> <tbody> <tr> <td>SignInterpretation</td> <td>Device default</td> </tr> <tr> <td></td> <td>Device default</td> </tr> <tr> <td></td> <td>One's Complement</td> </tr> <tr> <td></td> <td>Two's Complement</td> </tr> </tbody> </table>	Parameter	Value	SignInterpretation	Device default		Device default		One's Complement		Two's Complement	Description	Negation of the input value either one's or two's complement depending on the configuration.
	Parameter	Value										
	SignInterpretation	Device default										
		Device default										
		One's Complement										
		Two's Complement										
	Number of inputs	1										
Input data type	Signed Integer											
Input description	input: analog input value											
Number of outputs	1											
Output data type	Output 1 ("-"): Identical to input data type											
Output description	result: The one's or two's complement of the input value. (So the analog output value is the opposite of the input value).											
Settings	Selection of the one's or two's complement (Default Two's Complement)											
	Description	Subtraction of the two input values.										
	Number of inputs	2										
	Input data type	Integer										
	Input description	num1: first input value num2: second input value										
	Number of outputs	1										
	Output data type	Output 1 ("-"): Identical to input data type										
	Output description	result: Result after subtraction of the two input values										
Settings	No settings available											



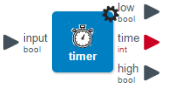
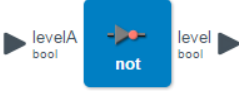

 <p>num1 int num2 int</p> <p>lt bool leq bool eq bool geq bool gt bool</p>	Description	Compares the two analog input values: It is set when input 1 less than input 2. leq is set when input 1 less than or equal input 2. Eq us set when input 1 equal input 2. Geq is set when input 1 greater than or equal input 2. Gt is set when input 1 greater than input 2.
	Number of inputs	2
	Input data type	Integer
	Input description	num1: first input value num2: second input value
	Number of outputs	1 ... 5
	Output data type	Output 1 ("<"): 1-bit Output 2 ("≤"): 1-bit Output 3 ("="): 1-bit Output 4 ("≥"): 1-bit Output 5 (">"): 1-bit
	Output description	lt: < input is less than input 2 leq: ≤ input 1 is less or equal to input 2 eq: = input 1 is equal to input 2 geq: ≥ input 1 is greater or equal to input 2 gt: > input 1 is greater than input 2
	Settings	No settings available
 <p>num1 bool num2 int num3 int</p> <p>result int</p>	Description	Selection between two analog input values depending on the boolean input.
	Number of inputs	3
	Input data type	Integer & Boolean Input 1 ("If"): 1-bit Input 2 ("Then"): Any Input 3 ("Else"): Any
	Input description	num1: Boolean input num2: Analog input 1 num3: Analog input 2
	Number of outputs	1
	Output data type	Integer
	Output description	result: If num1 is 1, then num2 is forwarded to the result. If num1 is 0, then num3 is forwarded to the result (false means 0).
	Settings	No settings available

	Description	Basic RS-Flip Flop functionality. if (set == false and reset == false) then Q = Keeps it's last value elseif (set == false and reset == true) then Q = false elseif (set == true and reset == false) then Q = true elseif (set == true and reset == true) then Q = false end
	Number of inputs	2
	Input data type	Input 1 ("Set"): 1-bit Input 2 ("Reset"): 1-bit
	Input description	set: See above truth table description reset: See above truth table description
	Number of outputs	2
	Output data type	Output 1 ("Q"): 1-bit Output 2 ("/Q"): 1-bit
	Output description	Q: See above in description notQ: Always equals Q inverted
	Settings	No settings available
	Description	Conversion of an analog input to four digital outputs.
	Number of inputs	1
	Input data type	Integer
	Input description	analogValue: analog input value
	Number of outputs	4
	Output data type	Output 1 ... 16: 1-bit
	Output description	out1: first digital output out2: second digital output out4: third digital output out8: fourth digital output
Settings	To select which half byte should be connected to the output (Default First half byte) If First half byte selected send lowest 4 bits (bits marked with x) --- --- --- xxxx If Second half byte selected send bits marked with x --- --- xxxx --- If Third half byte selected send bits marked with x --- xxxx --- --- If Fourth half byte selected send bits marked with x xxxx --- --- ---	

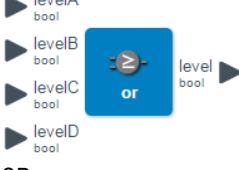
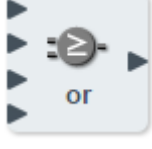
 <p>Parameter Value</p> <p>Selection Device default</p> <ul style="list-style-type: none"> Device default First half byte Second half byte Third half byte Fourth half byte 	<p>Description</p> <p>Number of inputs</p> <p>Input data type</p> <p>Input description</p> <p>Number of outputs</p> <p>Output data type</p> <p>Output description</p> <p>Settings</p>	<p>Conversion of four digital inputs to an analog half byte value.</p> <p>4</p> <p>Input 1 ... 16: 1-bit</p> <p>in1: first digital input in2: second digital input in4: third digital input in8: fourth digital input</p> <p>1</p> <p>Output 1: Integer or UInteger, 8 or 16 bits</p> <p>analogValue: analog half byte output value</p> <p>To select which half byte should be connected to the output (Default First half byte) If First half byte selected send lowest 4 bits (bits marked with x) --- --- --- xxxx If Second half byte selected send bits marked with x --- --- xxxx --- If third half byte selected send bits marked with x --- xxxx --- --- If Fourth half byte selected send bits marked with x xxxx --- --- ---</p>
 <p>Parameter Value</p> <p>OnDelay Device default</p> <p>OffDelay Device default</p>	<p>Description</p> <p>Number of inputs</p> <p>Input data type</p> <p>Input description</p> <p>Number of outputs</p> <p>Output data type</p> <p>Output description</p> <p>Settings</p>	<p>The input signal is delayed by the configured time.</p> <p>1</p> <p>1-bit</p> <p>input: input value</p> <p>1</p> <p>1-bit</p> <p>output: when the input becomes true, the output becomes true after a preset time delay. The output remains true as long as the input is true. When the input is false or becomes false, the output becomes false with no delay.</p> <p>OnDelay: Set delay for a rising edge transmitted to the output (Default 1 ms) OffDelay: Set delay for a falling edge transmitted to the output (Default 1 ms) The may. delay value for one delay is: 65535 ms The falling edge is configured with the OffDelay setting.</p>

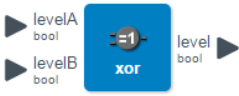
 <table border="1" data-bbox="159 283 399 493"> <thead> <tr> <th>Parameter</th> <th>Value</th> </tr> </thead> <tbody> <tr> <td>EnableMode</td> <td>Device default</td> </tr> <tr> <td>TimeBase</td> <td>Device default</td> </tr> <tr> <td>HighLimit</td> <td>Rising Edge (RISE)</td> </tr> <tr> <td>LowLimit</td> <td>Falling Edge (FALL)</td> </tr> <tr> <td>TimeBase</td> <td>Device default</td> </tr> <tr> <td>HighLimit</td> <td>10 ms (10)</td> </tr> <tr> <td>LowLimit</td> <td>100 ms (100)</td> </tr> </tbody> </table>	Parameter	Value	EnableMode	Device default	TimeBase	Device default	HighLimit	Rising Edge (RISE)	LowLimit	Falling Edge (FALL)	TimeBase	Device default	HighLimit	10 ms (10)	LowLimit	100 ms (100)	<p>Description</p> <p>Number of inputs</p> <p>Input data type</p> <p>Input description</p> <p>Number of outputs</p> <p>Output data type</p> <p>Output description</p> <p>Settings</p>	<p>Measures the pulse time of the digital input signal triggered by the rising or falling edge depending on the configuration. Information: There is no reset. Once it reaches the High Limit it stops.</p> <p>1</p> <p>Input 1 ("Enable"): 1-bit</p> <p>input: input signal</p> <p>3</p> <p>Output 1 ("High"): 1-bit Output 2 ("Time"): UInteger 16 Output 3 ("Low"): 1-bit</p> <p>low: This output is active when the time output is lower than LowLimit (Information: The 1 ms option is not available). time: This value increments once per TimeBase whenever input is active. high: This output is active when the time output is higher than the HighLimit.</p> <p>EnableMode: Enable mode to define which time to be measured. Either between rising and falling edge of the input signal or between falling and rising edge (Default Rising Edge) TimeBass: Select the time base for the time measurement (Default 100 ms) HighLimit: Defines a high value for the boolean output signal which is set when the timer value exceeds the defined high limit (Default 0) LowLimit: Defines a low value for the boolean output signal which is set when the timer value is lower than the defined low limit (Default 0)</p>
Parameter	Value																	
EnableMode	Device default																	
TimeBase	Device default																	
HighLimit	Rising Edge (RISE)																	
LowLimit	Falling Edge (FALL)																	
TimeBase	Device default																	
HighLimit	10 ms (10)																	
LowLimit	100 ms (100)																	
	<p>Description</p> <p>Number of inputs</p> <p>Input data type</p> <p>Input description</p> <p>Number of outputs</p> <p>Output data type</p> <p>Output description</p> <p>Settings</p>	<p>Invert the input signal with a logical NOT.</p> <p>1</p> <p>1-bit (future extension: or n-bit)</p> <p>levelA: first input value</p> <p>1</p> <p>Identical to input data type</p> <p>level: the input signal will be inverted with a logical not. Example: a high signal gets converted into a low signal.</p> <p>No settings available</p>																

 <p>AND</p>  <p>Table 13: Thruth table</p> <table border="1" data-bbox="159 588 399 829"> <thead> <tr> <th>Input A</th> <th>Input B</th> <th>Out-put</th> </tr> </thead> <tbody> <tr> <td>1</td> <td>1</td> <td>1</td> </tr> <tr> <td>1</td> <td>0</td> <td>0</td> </tr> <tr> <td>0</td> <td>1</td> <td>0</td> </tr> <tr> <td>0</td> <td>0</td> <td>0</td> </tr> </tbody> </table>	Input A	Input B	Out-put	1	1	1	1	0	0	0	1	0	0	0	0	<p>Description</p> <p>Number of inputs</p> <p>Input data type</p> <p>Input description</p> <p>Number of outputs</p> <p>Output data type</p> <p>Output description</p> <p>Settings</p>	<p>Combine the input signals with a logical AND.</p> <p>4</p> <p>1-bit (future extension: n-bit)</p> <p>levelA: first input levelB: second input levelC: third input levelD: fourth input Maximum 4 inputs can be linked together. If you want to link more signals, you can work with several AND blocks.</p> <p>1</p> <p>Identical to input data type</p> <p>level: the output depends on the various inputs. For more information see truth table</p> <p>No settings available</p>
Input A	Input B	Out-put															
1	1	1															
1	0	0															
0	1	0															
0	0	0															
 <p>OR</p>  <p>Table 14: Thruth table</p> <table border="1" data-bbox="159 1260 399 1491"> <thead> <tr> <th>Input A</th> <th>Input B</th> <th>Out-put</th> </tr> </thead> <tbody> <tr> <td>1</td> <td>1</td> <td>1</td> </tr> <tr> <td>1</td> <td>0</td> <td>1</td> </tr> <tr> <td>0</td> <td>1</td> <td>1</td> </tr> <tr> <td>0</td> <td>0</td> <td>0</td> </tr> </tbody> </table>	Input A	Input B	Out-put	1	1	1	1	0	1	0	1	1	0	0	0	<p>Description</p> <p>Number of inputs</p> <p>Input data type</p> <p>Input description</p> <p>Number of outputs</p> <p>Output data type</p> <p>Output description</p> <p>Settings</p>	<p>Combine the input signals with a logical OR.</p> <p>4</p> <p>1-bit (future extension: n-bit)</p> <p>levelA: first input levelB: second input levelC: third input levelD: fourth input Maximum 4 inputs can be linked together. If you want to link more signals, you can work with several OR blocks.</p> <p>1</p> <p>Identical to input data type</p> <p>level: the output depends on the various inputs. For more information see truth table</p> <p>No settings available</p>
Input A	Input B	Out-put															
1	1	1															
1	0	1															
0	1	1															
0	0	0															

 <p>XOR</p>  <p>Table 15: Thruth table</p> <table border="1" data-bbox="159 514 399 745"> <thead> <tr> <th>Input A</th> <th>Input B</th> <th>Out-put</th> </tr> </thead> <tbody> <tr> <td>1</td> <td>1</td> <td>0</td> </tr> <tr> <td>1</td> <td>0</td> <td>1</td> </tr> <tr> <td>0</td> <td>1</td> <td>1</td> </tr> <tr> <td>0</td> <td>0</td> <td>0</td> </tr> </tbody> </table>	Input A	Input B	Out-put	1	1	0	1	0	1	0	1	1	0	0	0	<p>Description</p> <p>Number of inputs</p> <p>Input data type</p> <p>Input description</p> <p>Number of outputs</p> <p>Output data type</p> <p>Output description</p> <p>Settings</p>	<p>Combine the input signals with a logical XOR.</p> <p>2</p> <p>1-bit (future extension: or n-bit)</p> <p>levelA: first input levelB: second input Maximum 2 inputs can be linked together. If you want to link more signals, you can work with several XOR blocks.</p> <p>1</p> <p>Identical to input data type</p> <p>level: the output depends on the various inputs. For more information see truth table</p> <p>No settings available</p>
Input A	Input B	Out-put															
1	1	0															
1	0	1															
0	1	1															
0	0	0															
 <p>NAND</p>  <p>Table 16: Thruth table</p> <table border="1" data-bbox="159 1176 399 1407"> <thead> <tr> <th>Input A</th> <th>Input B</th> <th>Out-put</th> </tr> </thead> <tbody> <tr> <td>1</td> <td>1</td> <td>0</td> </tr> <tr> <td>1</td> <td>0</td> <td>1</td> </tr> <tr> <td>0</td> <td>1</td> <td>1</td> </tr> <tr> <td>0</td> <td>0</td> <td>1</td> </tr> </tbody> </table>	Input A	Input B	Out-put	1	1	0	1	0	1	0	1	1	0	0	1	<p>Description</p> <p>Number of inputs</p> <p>Input data type</p> <p>Input description</p> <p>Number of outputs</p> <p>Output data type</p> <p>Output description</p> <p>Settings</p>	<p>Combine the input signals with a logical NAND.</p> <p>4</p> <p>1-bit (future extension: or n-bit)</p> <p>levelA: first input levelB: second input levelC: third input levelD: fourth input Maximum 4 inputs can be linked together. If you want to link more signals, you can work with several NAND blocks.</p> <p>1</p> <p>Identical to input data type</p> <p>level: the output depends on the various inputs. For more information see truth table</p> <p>No settings available</p>
Input A	Input B	Out-put															
1	1	0															
1	0	1															
0	1	1															
0	0	1															

<p>NOR</p> <p>Table 17: Thruth table</p> <table border="1"> <thead> <tr> <th>Input A</th> <th>Input B</th> <th>Out-put</th> </tr> </thead> <tbody> <tr><td>1</td><td>1</td><td>0</td></tr> <tr><td>1</td><td>0</td><td>0</td></tr> <tr><td>0</td><td>1</td><td>0</td></tr> <tr><td>0</td><td>0</td><td>1</td></tr> </tbody> </table>	Input A	Input B	Out-put	1	1	0	1	0	0	0	1	0	0	0	1	<p>Description</p> <p>Number of inputs</p> <p>Input data type</p> <p>Input description</p> <p>Number of outputs</p> <p>Output data type</p> <p>Output description</p> <p>Settings</p>	<p>Combine the input signals with a logical NOR.</p> <p>4</p> <p>1-bit (future extension: or n-bit)</p> <p>levelA: first input levelB: second input levelC: third input levelD: fourth input Maximum 4 inputs can be linked together. If you want to link more signals, you can work with several NOR blocks.</p> <p>1</p> <p>Identical to input data type</p> <p>level: the output depends on the various inputs. For more information see truth table</p> <p>No settings available</p>
Input A	Input B	Out-put															
1	1	0															
1	0	0															
0	1	0															
0	0	1															
<p>XNOR</p> <p>Table 18: Thruth table</p> <table border="1"> <thead> <tr> <th>Input A</th> <th>Input B</th> <th>Out-put</th> </tr> </thead> <tbody> <tr><td>1</td><td>1</td><td>1</td></tr> <tr><td>1</td><td>0</td><td>0</td></tr> <tr><td>0</td><td>1</td><td>0</td></tr> <tr><td>0</td><td>0</td><td>1</td></tr> </tbody> </table>	Input A	Input B	Out-put	1	1	1	1	0	0	0	1	0	0	0	1	<p>Description</p> <p>Number of inputs</p> <p>Input data type</p> <p>Input description</p> <p>Number of outputs</p> <p>Output data type</p> <p>Output description</p> <p>Settings</p>	<p>Combine the input signals with a logical XNOR.</p> <p>2</p> <p>1-bit (future extension: or n-bit)</p> <p>levelA: first input levelB: second input levelC: third input levelD: fourth input Maximum 4 inputs can be linked together. If you want to link more signals, you can work with several XNOR blocks.</p> <p>1</p> <p>Identical to input data type</p> <p>level: the output depends on the various inputs. For more information see truth table</p> <p>No settings available</p>
Input A	Input B	Out-put															
1	1	1															
1	0	0															
0	1	0															
0	0	1															

NOTE
Please be aware that the Integer values have a value range from 0...65.535. There is no overflow or underflow indication.

NOTE
The logic editor does only support integers (e. g. 2) and no decimal numbers (e. g. 2,345). In case, the calculated result would be a decimal number, the logic editor will round up or down.

8 Troubleshooting

The Troubleshooting table indicates measures to be taken if the sensor stops working.

LED indication

Table 19: LEDs on SIG100

LED	LED	Cause	Measures
Green power LED	○	Supply voltage off or too low	check all electrical connections (cables and plug connections)
Orange DI/DO LED	○	no input/output connected or signal low (=0)	check the input/output connections

9 Disassembly and disposal

The sensor must be disposed of according to the applicable country-specific regulations. Efforts should be made during the disposal process to recycle the constituent materials (particularly precious metals).



NOTE

Disposal of batteries, electric and electronic devices

- According to international directives, batteries, accumulators and electrical or electronic devices must not be disposed of in general waste.
- The owner is obliged by law to return this devices at the end of their life to the respective public collection points.



■ This symbol on the product, its package or in this document, indicates that a product is subject to these regulations.

10 Maintenance

SICK sensor integration gateways in are maintenance-free.

We recommend doing the following regularly:

- Clean the device
- Check the screwed and plugged connections

No modifications may be made to devices.

Subject to change without notice. Specified product properties and technical data are not written guarantees.

11 Technical data

11.1 General technical data

Mechanical data

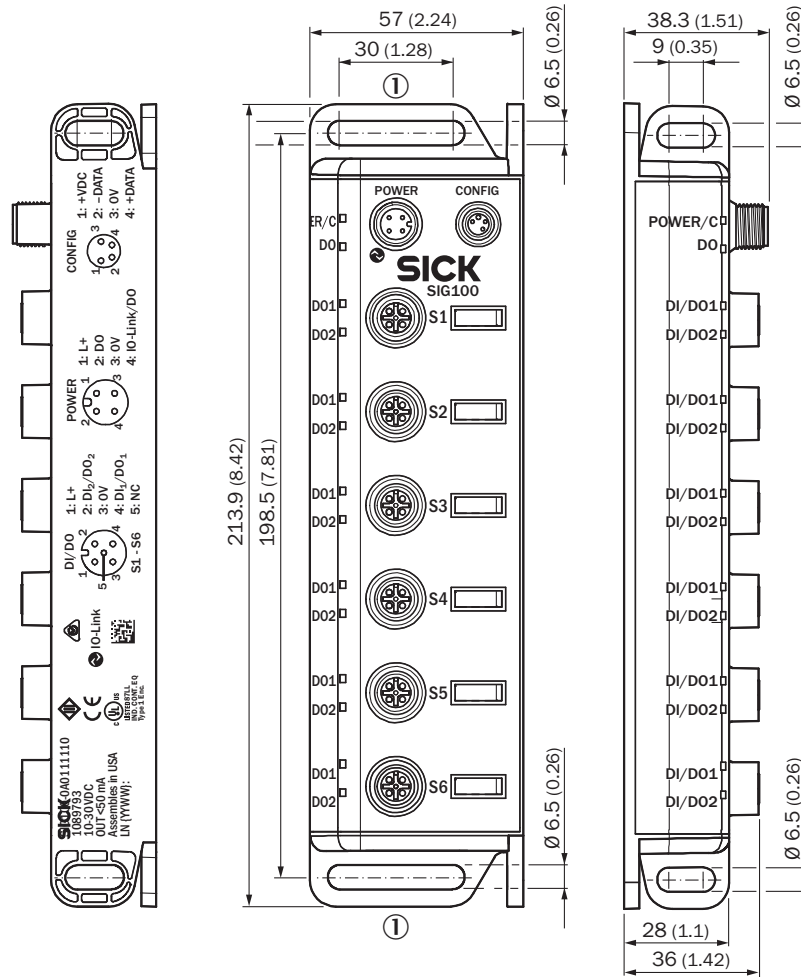

Figure 21: Dimensional drawing (dimensions in mm (inch))

① Long hole (4 x), for mounting with M6 screw

Housing material	ABS
Enclosure rating per IEC 60529	IP 67 (only when plugged-in and threaded-in)
Dimensions (W x H x D)	212 x 38.3 x 50 mm
Mounting type	2-hole screw mounting
Weight	289 g

Operating conditions

Operating temperature	-40 °C ... +60 °C
Storage temperature	-40 °C ... +70 °C
EMC - Immunity - Emission	- EN 61000-6-2 - EN 61000-6-4
Shock / shaking	EN 60068-2-6, EN 60068-2-27, EN 60068-2-29, EN 60068-2-64

Electrical data

Power supply SIO Mode	10 ... 30 V DC
Power supply IO-Link Mode	18 ... 30V DC
Noise	< 1 %
No load current	< 50mA
Maximum combined current consumption	500 mA (output load - no load current)
Sensor port current capability	50 mA
24 V current capability per port	100 mA
IO-Link Port output current capability per port	50 mA
Process data length	8 Byte (in), 2 Byte (out)
Transfer rate	COM2
IO-Link version	V1.1
SIO-mode supported	✓
Initialization time after switch on	< 8 s
Standard Output	$V_{OH} \geq V_{US} - 2 V$ Internal pull-down resistor = 100 k Ω
Standard Input voltage	$V_{IL} \text{ max} = 5.0 V$ and $V_{IH} \text{ min} = 8.0 V$
Standard Input current	US = 10.0 V: 0.7 mA max US = 24.0 V: 2.5 mA max US = 30.0 V: 3.0 mA max

12 Annex

Sensor Integration Gateway - SIG100

SICK Smart Sensors / IO-Link

Device configuration - Advanced operating instructions

SICK
Sensor Intelligence.

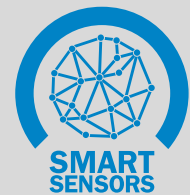

12.2 About this document

12.2.1 About this document

The ISDU descriptions in this document apply to IO-Link-enabled Sensor Integration Gateway SIG100.

In some cases, functions may be described in this document which are not supported by individual IO-Link devices from SICK. The functions in question are marked accordingly (see "Symbols", page 50).

The specific functional scope of an individual sensor or Sensor Integration Gateway is described in full in the Supplement to operating instructions on the relevant product page www.sick.com.

12.2.2 Intended use

Use IO-Link only as described in this documentation.

12.2.3 Symbols



NOTICE

This symbol indicates important information.



NOTE

This symbol provides additional information, e.g., dependencies / interactions between the described function and other functions, or when individual functions are not supported by every sensor.

12.3 Description of IO-Link

IO-Link and control integration

IO-Link is a non-proprietary internationally standardized communication technology, which makes it possible to communicate with sensors and actuators in industrial environments (IEC 61131-9).

IO-Link devices (also called IO-Link Slaves) communicate with higher-level control systems via an IO-Link Master. The IO-Link devices are connected to these via a point-to-point connection. An IO-Link device can be an individual IO-Link sensor or a Sensor Integration Gateway like SIG100. SIG100 is acting as an IO-Link Sensor Hub, collecting binary switching signals and converting them into one IO-Link Message.

Different variants of IO-Link Master are available for an easy integration into the most common industrial fieldbus environments. In most cases, they are remote fieldbus gateways or input cards for the backplane bus of the control used.

To make it possible for an IO-Link sensor to communicate with the control, both the IO-Link Master and the IO-Link device must be integrated in the hardware configuration in the control manufacturer's Engineering Tool.

To simplify the integration process, SICK provides sensor-specific device description files (IODD = IO-Link Device Description) for IO-Link devices.

You can download these device description files free of charge: [www.sick.com/\[device-part number\]](http://www.sick.com/[device-part number]).

Not all control system manufacturers support the use of IODDs. If third-party IO-Link Masters are used, it is possible to integrate the IO-Link sensor by manually entering the relevant sensor parameters directly during the hardware configuration.

To ensure that the IO-Link device can be easily integrated into the control program, SICK also provides function blocks for many control systems. These function blocks make it easier to read and write the individual device parameters and provide support when it comes to interpreting the process data supplied by the IO-Link device.

You can also download them free of charge from the homepage: [www.sick.com/\[device-part number\]](http://www.sick.com/[device-part number]).

On SICK's YouTube channel, you can find some tutorials, which will help you to integrate SICK IO-Link Masters: www.youtube.com/SICKSensors.

If you have any questions, SICK's Technical Support is available to help all over the world.

12.4 Accessories for visualization, configuration and integration

Using the M8 Configuration port (USB) on the SIG100 and in combination with one of the suitable accessory cables (e. g. 6051163), you can easily connect the Sensor Integration Gateway from SICK to a PC or a laptop via USB. You can then quickly and easily test or configure the SIG100 (→ including logic functions across multiple connected binary switching sensors which are connected to SIG100) using the SOPAS ET software (SICK Engineering Tool).

The needed visualization files (SDD = SOPAS Device Description) can be easily uploaded from the device itself when the device is connected the first time to SOPAS.

You can download SOPAS ET and the device-specific SDDs directly and free of charge from the SICK homepage: www.sick.com.

There are two different SDD files provided for SIG100. One for the use of SOPAS via USB (via the USB cable) and one for the use of SOPAS via IO-Link (using SIG100 and a SiLink2 Master 1061790). Note: When using the IO-Link SDD and a SiLink2 Master together with SIG100 not all device functions can be accessed.

Various IO-Link Masters are available from SICK for integrating IO-Link Masters using fieldbus. For more details, see www.sick.com.

12.5 Data repository

When the current IO-Link standard V1.1 was introduced, the automatic data repository (Data Storage) was added to IO-Link's range of functions. The data repository allows the machine operator to replace defective IO-Link devices with corresponding replacement devices without having to reconfigure these manually.

When the data repository is activated, the IO-Link V1.1 Master always saves the last valid setting parameters of all connected IO-Link V1.1 devices in its local memory (up to 2KB). If you replace one of the connected IO-Link devices with another device which has the same device ID and functionality, the IO-Link Master will transfer the last valid parameter set of the previous IO-Link device to the new device automatically.

The data repository therefore means that devices can be replaced in a plug-and-play manner within a matter of seconds – without complex reconfiguration, special hardware or software tools, and specific specialist knowledge.



NOTE

- To use the data repository, you must activate it in the IO-Link Master.
- When the conversion of one or several IO-Link device parameters is initiated via the control, then the control must activate the **Data Storage Upload Request-Flag** as the final command in the sensor. Only this initiates the data repository.
- Uploading / downloading IO-Link device parameters using the data repository function can take up to 15 seconds depending on the volume of data and the IO-Link Master used (typical values; values can differ in practice).
- For details on using the data repository, see IO-Link Interface and System Specification, V1.1.2, chapter 10.4 Data Storage (DS) at www.io-link.com, Downloads menu item.

12.6 Physical Layer

The physical layer describes the basic IO-Link device data (see table below). The device data is automatically shared with the IO-Link Master. It is important to ensure that the connected IO-Link Master supports the performance of IO-Link device data for proper operation.



NOTICE

The maximum current consumption of the IO-Link Slave (including load at the outputs) must not exceed the permissible output current of the relevant port on the IO-Link Master.

Table 20: Physical layer - IO-Link device data

SIO Mode	yes
----------	-----

Min. Cycle Time	5.1 ms
Baud rate	COM 2 (38.4 kbit/s)
IO-Link Frame Type	F-Sequence Type 2 V
PD-In: Process data length, incoming (from the IO-Link device to the IO-Link Master)	8 Byte
PD-Out: Process data length, outgoing (from the IO-Link Master to the IO-Link Device)	2 Byte
Inputs	max. 12 x PNP, Type 1
Outputs	max. 12 x PNP
Supported IO-Link Version	V1.1

12.7 Process data

Process data is transmitted cyclically. There is no confirmation of receipt.

The Master determines the cycle time; however, this must not be less than the minimum cycle time of the IO-Link Slave.



NOTE

The Service data (acyclic data) does not influence the cycle time.

12.7.1 Process data structure

Table 21: PD IN SIG100 -> IO-Link Master

Byte	Bit	Value	Signal input / output	Data type
0 ... 1	Bit 63 ... 48	AV2	Analog value 2	UInteger 16
2 ... 3	Bit 47 ... 32	AV1	Analog value 1	UInteger 16
4	Bit 31	Reserved		
	Bit 30	Reserved		
	Bit 29	Reserved		
	Bit 28	Reserved		
	Bit 27	Reserved		
	Bit 26	Reserved		
	Bit 25	Reserved		
	Bit 24	Reserved		
5	Bit 23	Reserved		
	Bit 22	Reserved		
	Bit 21	Reserved		
	Bit 20	Reserved		
	Bit 19	Qint 12	Port 6 pin 2 (input or output)	Boolean
	Bit 18	Qint 11	Port 6 pin 4 (input or output)	Boolean
	Bit 17	Qint 10	Port 5 pin 2 (input or output)	Boolean
	Bit 16	Qint 9	Port 5 pin 4 (input or output)	Boolean

Byte	Bit	Value	Signal input / output	Data type
6	Bit 15	Qint 8	Port 4 pin 2 (input or output)	Boolean
	Bit 14	Qint 7	Port 4 pin 4 (input or output)	Boolean
	Bit 13	Qint 6	Port 3 pin 2 (input or output)	Boolean
	Bit 12	Qint 5	Port 3 pin 4 (input or output)	Boolean
	Bit 11	Qint 4	Port 2 pin 2 (input or output)	Boolean
	Bit 10	Qint 3	Port 2 pin 4 (input or output)	Boolean
	Bit 9	Qint 2	Port 1 pin 2 (input or output)	Boolean
	Bit 8	Qint 1	Port 1 pin 4 (input or output)	Boolean
7	Bit 7	QL8	Logic Editor output signal	Boolean
	Bit 6	QL7	Logic Editor output signal	Boolean
	Bit 5	QL6	Logic Editor output signal	Boolean
	Bit 4	QL5	Logic Editor output signal	Boolean
	Bit 3	QL4	Logic Editor output signal	Boolean
	Bit 2	QL3	Logic Editor output signal	Boolean
	Bit 1	QL2	Logic Editor output signal	Boolean
	Bit 0	QL1	Logic Editor output signal	Boolean

The following two data formats are available for Process Data out and are selected via the user interface (see ["Process data Select"](#), page 59).

Table 22: PD OUT IO-Link Master -> SIG100 / Mode 1

	Bit	Value	Signal input / output	Data type
0	Bit 15	IL16	Logic Editor input	Boolean
	Bit 14	IL15	Logic Editor input	Boolean
	Bit 13	IL14	Logic Editor input	Boolean
	Bit 12	IL13	Logic Editor input	Boolean
	Bit 11	IL12	Logic Editor input	Boolean
	Bit 10	IL11	Logic Editor input	Boolean
	Bit 9	IL10	Logic Editor input	Boolean
	Bit 8	IL9	Logic Editor input	Boolean
1	Bit 7	IL8	Logic Editor input	Boolean
	Bit 6	IL7	Logic Editor input	Boolean
	Bit 5	IL6	Logic Editor input	Boolean
	Bit 4	IL5	Logic Editor input	Boolean
	Bit 3	IL4	Logic Editor input	Boolean
	Bit 2	IL3	Logic Editor input	Boolean
	Bit 1	IL2	Logic Editor input	Boolean
	Bit 0	IL1	Logic Editor input	Boolean

Table 23: PD OUT IO-Link Master -> SIG100 / Mode 2

Byte	Bit	Value	Signal input / output	Data type
0 ... 1	Bit 0 ... 15	AV1	Analog value 1	UInteger 16

12.7.1.1 Process data description

Table 24: System-specific ISDUs - PD Descriptor

ISDU			Name	Data type	Data repository	Length	Access	Default value	Value/range ¹⁾
Index		Sub-Index							
DEC	HEX								
14	0E	-	PD Input descriptor	Array	-	9 Byte	ro	0x01 0x14 0x00 0x02 0x10 0x20 0x02 0x10 0x30	Octet String [3]
15	0F	-	PD Output descriptor	Array	-	3 Byte	ro	PD OUT Mode 1 0x01 0x10 0x00 PD OUT Mode 2 0x02 0x10 0x00	Octet String [1]

1) Description of the process data

PD input descriptor (ISDU 14) and **PD output descriptor** (ISDU 15) provide information about the data structure of the (input and output) process data. The coding is described in the **Smart Sensor profile** specification. Each part of the process data is described with 3 bytes.

Byte 1 Data type:
 0: OctetStringT
 1: Set of BoolT
 2: UIntegerT
 3: IntegerT
 4: Float32T.

Byte 2 Length of the data in bits.

Byte 3 Bit offset of the corresponding process data variables in the process data.

12.7.1.2 Process data input

Table 25: System-specific ISDUs – Process data input

ISDU			Name	Data type	Data repository	Length	Access	Default value	Value/range
Index		Sub-index							
DEC	HEX								
40	28	-	Process data input	PD in	-	8 byte	ro	-	-

In this ISDU, the current process data input (from IO-Link Device to IO-Link Master) is provided as an ISDU.

12.7.1.3 Process data output

Table 26: System-specific ISDUs – Process data output

ISDU			Name	Data type	Data repository	Length	Access	Default value	Value/range
Index		Sub-index							
DEC	HEX								
41	29	-	Process data output	PD Out	-	8 byte	ro	-	-

In this ISDU, the current process data out (from IO-Link Master to IO-Link Device) is provided as an ISDU.

12.7.1.4 Process data selection

In the following section, the process data, which is required for the application and is described under [chapter 12.7](#), can be set.

Table 27: Process data selection

ISDU			Name	Data type	Data repository	Length	Access	Default value	Value/range
Index		Sub-Index							
DEC	HEX								
120	78	-	Process data select	UInt	yes	8 Bit	rw	128	128 = PDOOut option 1 (IL1 ... IL6) 129 = PDOOut option 2 (Analog value)



NOTE

Only Process data out can be changed, process data In is fixed.

12.8 Service data

Service data is only exchanged between the control and IO-Link device via the IO-Link Master on request by the control (acyclically). The service data is designated as ISDU's. ISDU's allow the user to read information about the status of the connected IO-Link device and/or write new parameters to change the configuration.

The respective counterpart confirms receipt of the data.

If the IO-Link device does not answer within five seconds, the master reports a communication error.

12.8.1 Device identification

12.8.1.1 Device identification

Table 28: Device identification

ISDU			Name	Data type	Data repository	Length	Access	Default value	Value/range
Index		Sub-index							
DEC	HEX								
16	10	-	Vendor name	String	-	18 byte	ro	SICK AG	
17	11	-	Vendor text			64 byte		www.sick.com	
18	12	-	Product name			18 byte			
19	13	-	Product ID			32 byte		see Index 219	
219	DB	0	Article No.			32 byte			

The **Product ID** is also the part number of the connected IO-Link device.

For reasons of standardization, this may also contain a reference to ISDU 219. In this case, the **Product ID** (part number) is filed under ISDU 219.

12.8.1.2 Product text and serial number

Table 29: Device identification – Product text / serial number

ISDU			Name	Data type	Data repository	Length	Access	Default value	Value/range
Index		Sub-index							
DEC	HEX								
20	14	-	Product text	String	-	45 byte	ro	IO-Link Sensor Hub	
21	15	-	Serial Number			8 byte			

Format of the serial number:

YYWWnnnn (Y = year, W = week, n = sequential numbering)



NOTE

The serial number combined with the part number (**Product ID**) enables the device to be clearly identified.

12.8.1.3 Hardware and firmware version

Table 30: Device identification – Version

ISDU			Name	Data type	Data repository	Length	Access	Default value	Value/range
Index		Sub-index							
DEC	HEX								
22	16	-	Hardware version	String	yes	4 byte	ro	xxxx	
23	17	-	Firmware version	String	yes	.16 byte	ro	Vxxx.xxx.xxx	

These ISDUs indicates the hardware and software versions.

12.8.1.4 Definable names

Table 31: Device identification – Specific tag

ISDU			Name	Data type	Data repository	Length	Access	Default value	Value/range
Index		Sub-index							
DEC	HEX								
24	18	-	Application-specific tag	String	yes	32 byte	rw	*****	
64	40	-	Device-specific tag		No			*****	

In **Application-specific tag**, you can store any text with a maximum of 32 characters. This can be useful for describing the exact position or task of the sensor in the overall machine. The **Application-specific tag** is saved via the **Data repository**.

In **Device-specific tag**, you can also store any text with a maximum of 32 characters. This name is NOT saved via the **Data repository** and is therefore available for information which is valid temporarily or only on the specific device for which it was defined.

**NOTE**

The user can enter any UTF-8 character

12.8.1.5 Find me

Table 32: Device identification – Find me

ISDU			Name	Data type	Data repository	Length	Access	Default value	Value/range
Index		Sub-index							
DEC	HEX								
204	CC	-	Find me	UInt	No	8 bit	rw	0	0 = Find me deactivated 1 = Find me activated

The sensor can be uniquely identified using **Find me**. For machines with several identical devices, it is therefore possible to uniquely identify the device with which communication is currently taking place.

When **Find me** is activated, the orange DO indicator beside the power port on SIG100 flashes at 1Hz.

12.8.1.6 SICK-Profile version

Table 33: Device identification – SICK-profile version

ISDU			Name	Data type	Data repository	Length	Access	Default value	Value/range
Index		Sub-index							
DEC	HEX								
205	CD	-	SICK-Profile Version	String	No	4 byte	ro	1.01	

SICK IO-Link devices implement a defined set of functions identified by the SICK-Profile version. This ISDU indicates the version number.

12.8.2 General device settings

12.8.2.1 Restore factory settings/reset

Table 34: General device settings – Restore factory settings

ISDU			Name	Data type	Data repository	Length	Access	Default value	Value/range
Index		Sub-index							
DEC	HEX								
2	02	-	Standard command	UInt	-	8 bit	ro		128 = Device reset 130 = Restore factory settings

Device reset SIG100 performs a restart.
Restore factory settings SIG100 is reset to factory settings.

12.8.2.2 Data storage index

Table 35: General device settings – Data storage index

ISDU			Name	Data type	Data repository	Length	Access	Default value	Value/range
Index		Sub-index							
DEC	HEX								
3	03	-	Data Storage Index	Record	yes	111 byte	rw		

The SIG100 supports the IO-Link data storage feature. Up to 2 Kilobyte of SIG100 data can be stored in an IO-Link Master port. Data storage of SIG100 includes following indices:

- ISDU 12 - Device Access Locks
- ISDU 24 - Application Specific Tag
- ISDU 91 - IO-Link port output type pin 4
- ISDU 92 - IO-Link port output type pin 2
- ISDU 120 - Process data select
- ISDU 227 - Notification handling
- ISDU 4005 - DI/DO port configuration
- ISDU 4007 - Logic Editor configuration (part 1)
- ISDU 4008 - Logic Editor configuration (part 2)
- ISDU 4009 - Logic Editor configuration (part 3)
- ISDU 4010 - Logic Editor configuration (part 4)
- ISDU 4011 - Logic Editor configuration (part 5)
- ISDU 4012 - Logic Editor configuration (part 6)
- ISDU 4013 - Logic Editor configuration (part 7)
- ISDU 4014 - Logic Editor configuration size
- ISDU 4015 - DI/DO port1 pin 4 label
- ISDU 4016 - DI/DO port1 pin 2 label
- ISDU 4017 - DI/DO port2 pin 4 label
- ISDU 4018 - DI/DO port2 pin 2 label
- ISDU 4019 - DI/DO port3 pin 4 label
- ISDU 4020 - DI/DO port3 pin 2 label
- ISDU 4021 - DI/DO port4 pin 4 label
- ISDU 4022 - DI/DO port4 pin 2 label
- ISDU 4023 - DI/DO port5 pin 4 label
- ISDU 4024 - DI/DO port5 pin 2 label
- ISDU 4025 - DI/DO port6 pin 4 label
- ISDU 4026 - DI/DO port6 pin 2 label

12.8.2.3 General device settings

Table 36: General device settings – Device access locks

ISDU			Name	Data type	Data repository	Length	Access	Default value	Value/range	
Index		Sub-index							Bit no.	
DEC	HEX									
12	02	-	Device access locks (key lock)	Record	yes	2 byte	rw	0	0	
			Data storage lock						1	0 = Unlocked 1 = Locked
			Not available						2 - 15	Not available

With **Device access locks**, you can lock or unlock various sensor functions. The functionality has been recorded in the IO-Link interface specification.

Bit 1 Data storage lock You can lock the data repository functionality using bit 1. When the bit is set, the device rejects data repository write requests from the IO-Link Master with an error message.

12.8.2.4 Notification handling

Table 37: General device settings – Notification handling

ISDU			Name	Data type	Data repository	Length	Access	Default value	Value/range	
Index		Sub-index								
DEC	HEX									
227	E3	-	Notification handling	UInt	-	1 byte	rw	0	0 = All enabled 1 = All disabled 2 = Events enabled, PD invalid flag disabled 3 = Events disabled, PD invalid flag enabled	

Notification handling enables the generation of IO-Link events in the device and the function for marking the process data as invalid to be activated / deactivated.

12.8.3 SIG100 configuration settings

12.8.3.1 IO-Link port configuration

Table 38: IO-Link Port (Power/C) pin 2 and pin 4 configuration

ISDU			Name	Daten- typ	Da- ten- hal- tung	Länge	Zu- griff	De- fault- wert	Wert/Bereich
Index		Sub- In- dex							
DEC	HEX								
91	5B	-	IO-Link port output type pin 4	UInt	yes	8 Bit	rw	0	0 = PNP / IO-Link 2 = Push/Pull 3 = Deactivated
92	5C	-	IO-Link port output type pin 2	UInt	yes	8 Bit	rw	0	0 = PNP / IO-Link 2 = Push/Pull 3 = Deactivated

Default value for pin 4 is PNP, meaning IO-Link communication gets started automatically after the wake-up from IO-Link Master. In case SIG100 is connected e. g. to a standard digital input card from a PLC, pin 4 will stay in the default PNP mode and will be operating in SIO mode.

Pin 4 communication can be deactivated e. g. in case the SIG100 is acting as a standalone controller without connection to any upper system, like IO-Link Master / PLC.

Default value for Index 92 is PNP. Pin 2 deactivated means pin 2 in high-impedance state.



NOTE

Please choose the right pin 2/pin 4 configuration depending on your application.

12.8.3.2 Process data Select

Table 39: Process data Select

ISDU			Name	Data type	Data reposi- tory	Length	Access	Default value	Value/range
Index		Sub- index							
DEC	HEX								
120	78	-	Process data select	UInt	yes	1 byte	rw	128	128 = PDO option 1 (IL1 ... IL16) 129 = PDO option 2 (analog value)

Select which kind of process data output selection you would like to use. You can choose either 16 Logic Inputs or 1 analog value with 16 bits.

Be aware, the size of the process data output is always fixed, it is 2 byte (=16 bits).

12.8.3.3 DI/DO port configuration

Table 40: DI/DO port configuration

ISDU			Name	Data type	Data reposi- tory	Length	Access	Default value	Value/range
Index		Sub- index							
DEC	HEX								
4005	FA5	-	DI/DO port configura- tion	Record	-	2 byte	rw	-	Bit 0: Port S1 pin 4 Bit 1: Port S1 pin 2 Bit 2: Port S2 pin 4 Bit 3: Port S2 pin 2 ... Bit 10: Port S6 pin 4 Bit 11: Port S6 pin 2

Select the port mode digital input or digital output for the 6 sensor ports S1-S6 depending on the devices you would like to connect.

To configure a pin as an output you set the corresponding bit in index 4005 to 1. To configure a pin as an input you set the corresponding bit in index 4005 to 0 (-> DI = 0 and DO=1).

12.8.3.4 Logic Editor configuration

Table 41: Logic Editor configuration

ISDU			Name	Data type	Data repository	Length	Access	Default value	Value/range
Index		Sub-Index							
DEC	HEX								
4007	FA7	-	Logic Editor configuration (part 1)	OStr	-	228 Byte	rw	-	
4008	FA8		Logic Editor configuration (part 2)						
4009	FA9		Logic Editor configuration (part 3)						
4010	FAA		Logic Editor configuration (part 4)						
4011	FAB		Logic Editor configuration (part 5)						
4012	FAC		Logic Editor configuration (part 6)						
4013	FAD		Logic Editor configuration (part 7)						
4014	FAE		Logic Editor configuration size						

Logic editor part 1- part 7 represents the logic editor configuration (recipe) The Logic editor configuration size is a 16 bit value and indicated the length of the logic editor configuration file.

12.8.3.5 DI/DO ports

Table 42: DI/DO Ports

ISDU			Name	Data type	Data repository	Length	Access	Default value	Value/range
Index		Sub-index							
DEC	HEX								
4015	FAF		DI/DO Port S1 pin 4 Label	String	8 Byte	rw		pin label port 1 pin 4	
4016	FB0		DI/DO Port S1 pin 2 Label					pin label port 1 pin 2	
4017	FB1		DI/DO Port S2 pin 4 Label					pin label port 2 pin 4	
4018	FB2		DI/DO Port S2 pin 2 Label					pin label port 2 pin 2	
4019	FB3		DI/DO Port S3 pin 4 Label					pin label port 3 pin 4	
4020	FB4		DI/DO Port S3 pin 2 Label					pin label port 3 pin 2	
4021	FB5		DI/DO Port S4 pin 4 Label					pin label port 4 pin 4	
4022	FB6		DI/DO Port S4 pin 2 Label					pin label port 4 pin 2	
4023	FB7		DI/DO Port S5 pin 4 Label					pin label port 5 pin 4	
4024	FB8		DI/DO Port S5 pin 2 Label					pin label port 5 pin 2	
4025	FB9		DI/DO Port S6 pin 4 Label					pin label port 6 pin 4	
4026	FBA		DI/DO Port S6 pin 2 Label					pin label port 6 pin 2	

Index 4015 until 4026 identify the virtual DI/DO port labels for pin 2 and pin 4 of each of the 6 configurable ports (S1-S6).

**NOTE**

UTF-8 characters are allowed. The max. length for each label is 8 bytes. Please be aware that some UTF-8 characters need more than 1 byte (e.g. German umlauts need 2 bytes, Chinese/Japanese characters need 3 bytes). That is why the label length depends on the use of the chosen symbols.

The User Interface SOPAS will cut off labels with more than 8 bytes.

12.8.4 Installation / Diagnostics

12.8.4.1 Device State

Table 43: Device state

ISDU			Name	Data type	Data repository	Length	Access	Default value	Value/range
Index		Sub-index							
DEC	HEX								
36	24	-	Device status	UInt	-	1 byte	ro	0	0 = Device is OK 1 = Maintenance required 2 = Out of specification 3 = Functional check 4 = Failure 5 - 255 = Reserved

12.8.5 System-specific ISDUs

12.8.5.1 Profile characteristic

Table 44: System-specific ISDUs – Profile characteristic

ISDU			Name	Data type	Data repository	Length	Access	Default value	Value/range
Index		Sub-index							
DEC	HEX								
13	D	-	Profile characteristic	Array	-	8 byte	ro	-	UInt 16 [4]

Profile characteristic indicates which standardized profiles and functionalities the sensor supports. The values are emitted in five 16-bit blocks.

At most, the following profiles / functionalities are supported:

- 1 PID (Profile Identifier) “Smart Sensor Profile”.
- 32768 Device Identification
The device supports enhanced identification options, see Identification chapter.
- 32769 Binary Data Channel
The device provides switching signals in a specified manner.
- 32770 Process data variables
The sensor provides analog values as items of process data.

12.9 Events

IO-Link communication is a master-slave communication system.

With “Events”, an IO-Link device reports events to the master (without being prompted by the master). Device-specific events are classified as follows:

Table 45: Device-specific events

Notification	For information purposes only; system is not restricted.
Warning	System is still functional, but is impaired in some way. You must rectify this with suitable measures as soon as possible.
Error	System is no longer functional. Depending on the cause of the error, it may be possible to restore functionality.

An event issues an event code, which contains the cause of the occurrence of the event.



NOTE

Not all IO-Link masters support the event mechanism.

You can deactivate the generation of events on the device side in ISDU 227 Notification handling.

The following events are supported:

12.9.1 Events

Table 46: Events

Code		Name	Type	Comment	Action
Dec	Hex				
36001	8CA1	New parameters	Notification	Parameters have been amended	None

12.10 Errors

Table 47: Errors

Code				Name	Remark	Action
Dec	Hex	Additional Code / Dec	Additional Code / Hex			
128	80	17	11	Index not available	Access occurs to a not existing index	
128	80	18	12	Subindex not available	Access occurs to a not existing subindex	

Code				Name	Remark	Action
Dez	Hex	Additional Code / Dez	Additional Code / Hex			
128	80	32	20	Service temporarily not available	Parameter is not accessible due to the current state of the device application	
128	80	34	22	Service temporarily not available - device control	Parameter is not accessible due to a remote triggered state of the device application	
128	80	35	23	Access denied	Write access on a read-only parameter	
128	80	48	30	Parameter value out of range	Written parameter value is outside its permitted value range	
128	80	51	33	Parameter length overrun	Written parameter length is above its predefined length	
128	80	52	34	Parameter length underrun	Written parameter length is below its predefined length	
128	80	53	35	Function not available	Written command is not supported by the device application	
128	80	54	36	Function temporarily unavailable	Written command is not available due to the current state of the device application	
128	80	65	41	Inconsistent parameter set	Parameter inconsistencies were found at the end of block parameter transfer, device plausibility check failed	

12.11 Index

I

ISDU

0002 Standard command (Restore).....	57
0003 Data Storage Index.....	57
0012 Device access locks.....	58
0013 Profile characteristic.....	63
0014 Input descriptor.....	54
0015 Output descriptor.....	54
0016 Vendor name.....	55
0017 Vendor text.....	55
0018 Product name.....	55
0019 Product ID.....	55
0020 Product text.....	55
0021 Serial Number.....	55
0022 Hardware version.....	56
0023 Firmware version.....	56
0024 Application-specific tag.....	56
0036 Device status.....	62
0040 Process Data Input.....	54
0041 Process Data Output.....	54
0064 Device-specific name.....	56
0091 IO-Link port output type Pin 4.....	59
0092 IO-Link port output type Pin 2.....	59
0120 Process data select.....	55, 59
0128 Errors.....	63, 63, 64, 64, 64, 64, 64, 64, 64, 64, 64
0204 Find me.....	56
0205 SICK-Profile Version.....	56
0219 Product ID.....	55
0227 Notification handling.....	58
36001 New parameters.....	63
4005 DI/DO port configuration.....	59
4007 Logic Editor configuration (part 1).....	60
4008 Logic Editor configuration (part 2).....	60
4009 Logic Editor configuration (part 3).....	60
4010 Logic Editor configuration (part 4).....	60
4011 Logic Editor configuration (part 5).....	60
4012 Logic Editor configuration (part 6).....	60
4013 Logic Editor configuration (part 7).....	60
4014 Logic Editor configuration size.....	60
4015 DI/DO port1 pin4 label.....	61
4016 DI/DO port1 pin2 label.....	61
4017 DI/DO port2 pin4 label.....	61
4018 DI/DO port2 pin2 label.....	61
4019 DI/DO port3 pin4 label.....	61
4020 DI/DO port3 pin2 label.....	61
4021 DI/DO port4 pin4 label.....	61
4022 DI/DO port4 pin2 label.....	61
4023 DI/DO port5 pin4 label.....	61
4024 DI/DO port5 pin2 label.....	61
4025 DI/DO port6 pin4 label.....	61
4026 DI/DO port6 pin2 label.....	61

12.12 List of abbreviations

Table 48: List of abbreviations

AN1	Analog value (In)	
ANO	Analog value (Out)	
COM 1 - 3	SDCI communication mode	1 = 4.8 kbit/s 2 = 38.4 kbit/s 3 = 230.4 kbit/s
CON	Constant	Constant value for calculations within the logic editor
CONFIG	Configuration Configuration Port (M8) on SIG100	
DI	Digital Input	Digital input (e. g. Sensor connected to one of the ports S1-S6)
DO	Digital Output	Digital Output (e. g. Actuator connected to one of the ports S1-S6)
IL	Logic Editor Input	
Int	Integer	
IODD	IO-Link Device Description	Device description file of an IO-Link device
ISDU	Indexed Service Data Unit	Service data object in IO-Link
OF	Over Flow	
PD In	Process Data from SIG100 to IO-Link Master/PLC	
PD Out	Process Data from IO-Link Master/PLC to SIG100	
PID	Profile Identifier	
Qint	Output on the Ports (S1-S6)	
QL	Logic Editor Output	
S1DI1	Port S1 Digital Input 1	Port S1 pin number 4 is used as a digital input
S1DO2	Port S1 Digital Output 1	Port S1 pin number 4 is used as a digital output
SDCI	Single-drop digital interface	Official (specification) name for IO-Link technology
SDD	SOPAS ET Device Description	Device description file / driver for SICK SOPAS ET software
SIG	Sensor Integration Gateway	Active Connectivity Products made by SICK
SIO-Mode	Standard Input Output Mode	
SOPAS ET	SOPAS Engineering Tool	The SOPAS Engineering tool is the configuration software from SICK
UInt	Unsigned Integer	
UF	Under Flow	

Australia

Phone +61 (3) 9457 0600
1800 33 48 02 – tollfree
E-Mail sales@sick.com.au

Austria

Phone +43 (0) 2236 62288-0
E-Mail office@sick.at

Belgium/Luxembourg

Phone +32 (0) 2 466 55 66
E-Mail info@sick.be

Brazil

Phone +55 11 3215-4900
E-Mail comercial@sick.com.br

Canada

Phone +1 905.771.1444
E-Mail cs.canada@sick.com

Czech Republic

Phone +420 2 57 91 18 50
E-Mail sick@sick.cz

Chile

Phone +56 (2) 2274 7430
E-Mail chile@sick.com

China

Phone +86 20 2882 3600
E-Mail info.china@sick.net.cn

Denmark

Phone +45 45 82 64 00
E-Mail sick@sick.dk

Finland

Phone +358-9-25 15 800
E-Mail sick@sick.fi

France

Phone +33 1 64 62 35 00
E-Mail info@sick.fr

Germany

Phone +49 (0) 2 11 53 01
E-Mail info@sick.de

Hong Kong

Phone +852 2153 6300
E-Mail ghk@sick.com.hk

Hungary

Phone +36 1 371 2680
E-Mail ertekesites@sick.hu

India

Phone +91-22-6119 8900
E-Mail info@sick-india.com

Israel

Phone +972-4-6881000
E-Mail info@sick-sensors.com

Italy

Phone +39 02 27 43 41
E-Mail info@sick.it

Japan

Phone +81 3 5309 2112
E-Mail support@sick.jp

Malaysia

Phone +603-8080 7425
E-Mail enquiry.my@sick.com

Mexico

Phone +52 (472) 748 9451
E-Mail mario.garcia@sick.com

Netherlands

Phone +31 (0) 30 229 25 44
E-Mail info@sick.nl

New Zealand

Phone +64 9 415 0459
0800 222 278 – tollfree
E-Mail sales@sick.co.nz

Norway

Phone +47 67 81 50 00
E-Mail sick@sick.no

Poland

Phone +48 22 539 41 00
E-Mail info@sick.pl

Romania

Phone +40 356-17 11 20
E-Mail office@sick.ro

Russia

Phone +7 495 283 09 90
E-Mail info@sick.ru

Singapore

Phone +65 6744 3732
E-Mail sales.gsg@sick.com

Slovakia

Phone +421 482 901 201
E-Mail mail@sick-sk.sk

Slovenia

Phone +386 591 78849
E-Mail office@sick.si

South Africa

Phone +27 (0)11 472 3733
E-Mail info@sickautomation.co.za

South Korea

Phone +82 2 786 6321
E-Mail info@sickkorea.net

Spain

Phone +34 93 480 31 00
E-Mail info@sick.es

Sweden

Phone +46 10 110 10 00
E-Mail info@sick.se

Switzerland

Phone +41 41 619 29 39
E-Mail contact@sick.ch

Taiwan

Phone +886-2-2375-6288
E-Mail sales@sick.com.tw

Thailand

Phone +66 2 645 0009
E-Mail marcom.th@sick.com

Turkey

Phone +90 (216) 528 50 00
E-Mail info@sick.com.tr

United Arab Emirates

Phone +971 (0) 4 88 65 878
E-Mail info@sick.ae

United Kingdom

Phone +44 (0)17278 31121
E-Mail info@sick.co.uk

USA

Phone +1 800.325.7425
E-Mail info@sick.com

Vietnam

Phone +65 6744 3732
E-Mail sales.gsg@sick.com

Further locations at www.sick.com

