

RMS1000 (Model RMS-A)

Radar sensors

SICK
Sensor Intelligence.



Described product

RMS1000 (Model RMS-A)

Manufacturer

SICK AG
Erwin-Sick-Str. 1
79183 Waldkirch
Germany

Legal information

This work is protected by copyright. Any rights derived from the copyright shall be reserved for SICK AG. Reproduction of this document or parts of this document is only permissible within the limits of the legal determination of Copyright Law. Any modification, abridgment or translation of this document is prohibited without the express written permission of SICK AG.

The trademarks stated in this document are the property of their respective owner.

© SICK AG. All rights reserved.

Original document

This document is an original document of SICK AG.

Contents

1	About this document.....	5
1.1	Information on the operating instructions.....	5
1.2	Explanation of symbols.....	5
2	Safety information.....	6
2.1	Intended use.....	6
2.2	Improper use.....	6
2.3	Limitation of liability.....	7
2.4	Modifications and conversions.....	7
2.5	Requirements for skilled persons and operating personnel.....	7
2.6	Operational safety and particular hazards.....	8
3	Product description.....	10
3.1	Scope of delivery.....	10
3.2	Connections and LEDs.....	10
4	Transport and storage.....	12
4.1	Transport.....	12
4.2	Unpacking.....	12
4.3	Transport inspection.....	12
4.4	Storage.....	12
5	Mounting.....	14
5.1	Mounting instructions.....	14
5.2	Mounting the device.....	14
6	Electrical installation.....	15
6.1	Wiring instructions.....	15
6.2	Connection diagram.....	15
6.3	Connection options.....	16
6.4	Connecting the device electrically.....	17
7	Operation.....	18
7.1	General advice.....	18
7.2	Switching off and on.....	18
7.3	Operation using SOPASair.....	18
7.3.1	Opening user interface.....	18
7.3.2	Overview.....	19
7.3.3	Home	20
7.3.4	Configuration > Basic settings	21
7.3.5	Configuration > Connection options	23
7.3.6	Application > Inputs/outputs	23
7.3.7	Application > Field evaluation	23
7.3.8	Diagnostics > Overview	24
7.4	Operation in SOPAS ET.....	25

7.5	RMS1000 terminal program.....	25
8	Maintenance.....	26
8.1	Maintenance plan.....	26
9	Troubleshooting.....	27
9.1	General faults, warnings, and errors.....	27
9.2	Repairs.....	27
9.3	Returns.....	27
9.4	Disposal.....	27
10	Technical data.....	29
10.1	Features.....	29
10.2	Performance.....	29
10.3	Interfaces.....	30
10.4	Mechanics/electronics.....	30
10.5	Ambient data.....	31
11	Accessories.....	33
12	Annex.....	34
12.1	EU declaration of conformity/Certificates.....	34
12.2	Cybersecurity.....	34
12.3	Licenses.....	34

1 About this document

1.1 Information on the operating instructions

These operating instructions provide important information on how to use devices from SICK AG.

Prerequisites for safe work are:

- Compliance with all safety notes and handling instructions supplied.
- Compliance with local work safety regulations and general safety regulations for device applications

The operating instructions are intended to be used by qualified personnel and electrical specialists.



NOTE

Read these operating instructions carefully to familiarize yourself with the device and its functions before commencing any work.

The operating instructions are an integral part of the product. Store the instructions in the immediate vicinity of the device so they remain accessible to staff at all times. Should the device be passed on to a third party, these operating instructions should be handed over with it.

These operating instructions do not provide information on operating the machine or system in which the device is integrated. For more information, refer to the operating instructions of the specific machine or system.

1.2 Explanation of symbols

Warnings and important information in this document are labeled with symbols. Signal words introduce the instructions and indicate the extent of the hazard. To avoid accidents, damage, and personal injury, always comply with the instructions and act carefully.



DANGER

... indicates a situation of imminent danger, which will lead to a fatality or serious injuries if not prevented.



WARNING

... indicates a potentially dangerous situation, which may lead to a fatality or serious injuries if not prevented.



CAUTION

... indicates a potentially dangerous situation, which may lead to minor/slight injuries if not prevented.



NOTICE

... indicates a potentially harmful situation, which may lead to material damage if not prevented.



NOTE

... highlights useful tips and recommendations as well as information for efficient and trouble-free operation.

2 Safety information

2.1 Intended use

The RMS1000 radar sensor is used for area monitoring. Within a defined detection area, the sensor detects static and moving objects, and triggers a switching signal upon detection of a corresponding object.

Distance zones can be defined and these zones can be assigned various functions.

The distance and speed of the objects within the detection area are determined and provided via the data telegram.

All object data can be provided via Ethernet. The ability to provide it via CAN J1939 is under development.

The device is operated via the SOPASair software from SICK AG.



NOTE

The radar sensor is approved for operation in countries listed in the RMS1000 “Regulatory Notes” technical information (no. 8026123). This document is included with the device. The operation of the device in other countries can interfere with protected frequency ranges.

- Only use the device in countries in which it has been approved.
- When reselling the device, inform the buyer about the regional approval restrictions.

SICK AG assumes no liability for losses or damage arising from the use of the product, either directly or indirectly. This applies in particular to use of the product that does not conform to its intended purpose and is not described in this documentation.

Health hazards as a result of high-frequency electromagnetic radiation

The RMS1000 radar sensor is designed for operation in accordance with ETSI EN 305550. During operation, the exposition limit values defined in EN 62311 must be adhered to.

In order to limit human exposure to electromagnetic fields, suitable safety distances must be maintained during both short-term and long-term work in the radiation range of the antenna. The minimum distance between the antenna and the human body during continuous operation is 20 cm.

Country-specific aspects which must be taken into account during operation of the device can be found in the RMS1000 “Regulatory Compliance Information” technical information publication (no. 8026123), which is included with the product.

2.2 Improper use

Any use outside of the stated areas, in particular use outside of the technical specifications and the requirements for intended use, will be deemed to be incorrect use.

- The device does not constitute a safety component in accordance with the respective applicable safety standards for machines.
- The device must not be used in explosion-hazardous areas.
- Any use of accessories not specifically approved by SICK AG is at your own risk.

**WARNING****Danger due to improper use!**

Any improper use can result in dangerous situations.

Therefore, observe the following information:

- Product should be used only in accordance with its intended use.
- All information in these operating instructions must be strictly observed.
- Shut down the product immediately in case of damage.

2.3 Limitation of liability

Relevant standards and regulations, the latest technological developments, and our many years of knowledge and experience have all been taken into account when compiling the data and information contained in these operating instructions. The manufacturer accepts no liability for damage caused by:

- Non-adherence to the product documentation (e.g., operating instructions)
- Incorrect use
- Use of untrained staff
- Unauthorized conversions or repair
- Technical modifications
- Use of unauthorized spare parts, consumables, and accessories

With special variants, where optional extras have been ordered, or owing to the latest technical changes, the actual scope of delivery may vary from the features and illustrations shown here.

2.4 Modifications and conversions

**NOTICE**

Modifications and conversions to the device may result in unforeseeable dangers.

Interrupting or modifying the device or SICK software will invalidate any warranty claims against SICK AG. This applies in particular to opening the housing, even as part of mounting and electrical installation.

2.5 Requirements for skilled persons and operating personnel

**WARNING****Risk of injury due to insufficient training.**

Improper handling of the device may result in considerable personal injury and material damage.

- All work must only ever be carried out by the stipulated persons.

This product documentation refers to the following qualification requirements for the various activities associated with the device:

- **Instructed personnel** have been briefed by the operator about the tasks assigned to them and about potential dangers arising from improper action.
- **Skilled personnel** have the specialist training, skills, and experience, as well as knowledge of the relevant regulations, to be able to perform tasks delegated to them and to detect and avoid any potential dangers independently.
- **Electricians** have the specialist training, skills, and experience, as well as knowledge of the relevant standards and provisions, to be able to carry out work on electrical systems and to detect and avoid any potential dangers independently. The electrician must comply with the provisions of the locally applicable work safety regulation.

The following qualifications are required for various activities:

Table 1: Activities and technical requirements

Activities	Qualification
Mounting, maintenance	<ul style="list-style-type: none"> ■ Basic practical technical training ■ Knowledge of the current safety regulations in the workplace
Electrical installation, device replacement	<ul style="list-style-type: none"> ■ Practical electrical training ■ Knowledge of current electrical safety regulations ■ Knowledge of the operation and control of the devices in their particular application
Commissioning, configuration	<ul style="list-style-type: none"> ■ Basic knowledge of the computer operating system used ■ Basic knowledge of the design and setup of the described connections and interfaces ■ Basic knowledge of data transmission
Operation of the device for the particular application	<ul style="list-style-type: none"> ■ Knowledge of the operation and control of the devices in their particular application ■ Knowledge of the software and hardware environment for the particular application

2.6 Operational safety and particular hazards

Please observe the safety notes and the warnings listed here and in other chapters of this product documentation to reduce the possibility of risks to health and avoid dangerous situations.



WARNING

Electrical voltage!

Electrical voltage can cause severe injury or death.

- Work on electrical systems must only be performed by qualified electricians.
- The power supply must be disconnected when attaching and detaching electrical connections.
- The product must only be connected to a voltage supply as set out in the requirements in the operating instructions.
- National and regional regulations must be complied with.
- Safety requirements relating to work on electrical systems must be complied with.

**WARNING****Risk of injury and damage caused by potential equalization currents!**

Improper grounding can lead to dangerous equipotential bonding currents, which may in turn lead to dangerous voltages on metallic surfaces, such as the housing. Electrical voltage can cause severe injury or death.

- Work on electrical systems must only be performed by qualified electricians.
 - Follow the notes in the operating instructions.
 - Install the grounding for the product and the system in accordance with national and regional regulations.
-

3 Product description

3.1 Scope of delivery

The delivery of the device includes the following components:

No. of units	Component	Remarks
1	Device in the version ordered	Without connecting cables and brackets
1	SOPASair configuration software	integrated into the device, access via web browser
1	Protective caps for electrical connections	Included or possibly attached to the device
1	Printed RMS1000 "Regulatory Notes" technical information (no. 8026123)	Informs about the countries for which an approval exists. Names country-specific aspects which are to be taken into account during operation of the device.
1	Printed safety notes, multilingual	Brief information and general safety notes

Components not contained in the delivery:

Component	Remarks
Telegram Listing RMS1000 (no. 8026613)	Detailed description of the telegrams, available at www.sick.com/RMS1000

3.2 Connections and LEDs



Figure 1: Connections and LEDs







- ① LED 1 Device (Dev)
- ② LED 2 Application (App)
- ③ Connection Ethernet
- ④ Connection CAN I/O
- ⑤ Connection Power

Connections

For details, see "Connection diagram", page 15.

LEDs

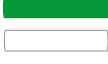
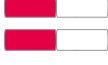
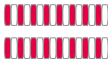

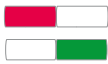

The LEDs indicate the following status information.

Device status	LED 1 Device (Dev) ¹ LED 2 Application (App) ¹	Description
Device off		Off Off
Initialization phase		Permanently red Permanently red
Parameterization		Permanently red Permanently red
Field clear ²		Permanently green Permanently green
Object detection ²		Permanently green Permanently yellow
No field created		Permanently green Off
Error (can be remedied by the customer)		Slowly flashing red Slowly flashing red Synchronous
Serious error (contact SICK Service)		Quickly flashing red Quickly flashing red Synchronous
Standby/save electricity		Permanently yellow Permanently red
Firmware update		Slowly flashing red Slowly flashing green Asynchronous

¹ Colors:

-  Red
-  Yellow
-  Green

Patterns:

-  Off
-  Permanently lit
-  Flashing slowly (1 Hz)
-  Flashing quickly (8 Hz)

² The LEDs indicate the status of the detection or evaluation in a field and not the status of the digital output. If the result of the field evaluation is inverted before being placed on the digital output, this has no effect on the LEDs.

4 Transport and storage

4.1 Transport

For your own safety, please read and observe the following notes:



NOTICE

Damage to the product due to improper transport.

- The device must be packaged for transport with protection against shock and damp.
- Recommendation: Use the original packaging as it provides the best protection.
- Transport should be performed by trained specialist staff only.
- The utmost care and attention is required at all times during unloading and transportation on company premises.
- Note the symbols on the packaging.
- Do not remove packaging until immediately before you start mounting.

4.2 Unpacking

- To protect the device against condensation, allow it to equilibrate with the ambient temperature before unpacking if necessary.
- Handle the device with care and protect it from mechanical damage.
- To avoid ingress of dust and water, only remove the protective caps of the electrical connections just before attaching the connecting cable.

4.3 Transport inspection

Immediately upon receipt in Goods-in, check the delivery for completeness and for any damage that may have occurred in transit. In the case of transit damage that is visible externally, proceed as follows:

- Do not accept the delivery or only do so conditionally.
- Note the scope of damage on the transport documents or on the transport company's delivery note.
- File a complaint.



NOTE

Complaints regarding defects should be filed as soon as these are detected. Damage claims are only valid before the applicable complaint deadlines.

4.4 Storage

Store the device under the following conditions:

- Recommendation: Use the original packaging.
- Electrical connections are provided with a protective cap (as in the delivery condition).
- Do not store outdoors.
- Store in a dry area that is protected from dust.
- To allow any residual dampness to evaporate, do not package in airtight containers.
- Do not expose to any aggressive substances.
- Protect from sunlight.
- Avoid mechanical shocks.
- Storage temperature: see "Technical data", page 29.

- Relative humidity: [see "Technical data", page 29.](#)
- For storage periods of longer than 3 months, check the general condition of all components and packaging on a regular basis.

5 Mounting

5.1 Mounting instructions

- Observe the technical data.
- Protect the sensor from direct sunlight.
- To prevent condensation, avoid exposing the device to rapid changes in temperature.
- The mounting site has to be designed for the weight of the device.
- It should be mounted so that it is exposed to as little shock and vibration as possible. Optional mounting accessories are available, [see "Accessories", page 33](#).
- The 4 threaded mounting holes on the left and right side of the housing are used to mount the device on a bracket. Only use screws with M5 thread. Insert the screws into the thread by a maximum of 9 mm.
- Use of a weather hood and a mounting bracket is recommended for outdoor installations. Information about optional accessories, ["Accessories", page 33](#).
- Do not mount device tilted toward the ground in order to prevent ground reflections, which could be detected as objects.
- Observe sensor blind zone. No detection is possible in the range up to 0.4 m.

5.2 Mounting the device

1. Mount the device in a suitably prepared bracket using the fixing holes provided. Mounting brackets are available as accessories, ["Accessories", page 33](#).
 2. Make the electrical connection. Attach and tighten a voltage-free cable, [see "Connecting the device electrically", page 17](#).
 3. Align the device with the center of the area to be monitored.
 4. Switch on the supply voltage.
- ✓ After successful initialization, the two status LEDs light up green. The device is ready for use.

6 Electrical installation

6.1 Wiring instructions



NOTE

Pre-assembled cables can be found online at:

- www.sick.com/RMS1000



NOTICE

Faults during operation and device or system defects!

Incorrect wiring may result in operational faults and defects.

- Follow the wiring notes precisely.

The enclosure rating stated in the technical data is achieved only with screwed plug connectors or protective caps.

Isolate the wires of unused digital outputs at the control cabinet.

All circuits connected to the device must be designed as ES1 circuits. The voltage source must meet the requirements of ES1 and PS2 (EN 62368-1).

Connect the connecting cables in a de-energized state. Do not switch on the supply voltage until installation is complete and all connecting cables are connected to the device and control.

Use proper connecting cables and male connectors for the application and environmental conditions, see "Accessories", page 33.

The supply voltage must be as specified in the technical data, see "Technical data", page 29.

The voltage supply via a power supply unit must be capable of buffering a brief power failure of up to 20 ms.

Prevent product damage caused by short-circuit: The device supply voltage input is equipped with reverse polarity protection. The internal functional earth is directly connected to the metal housing of the device. The internal functional earth also corresponds to the negative pole of the supply voltage.

6.2 Connection diagram

Ethernet

Table 2: Pin assignment for Ethernet connection

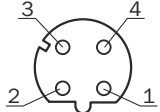
Male/female connector	Pin	Short form	Signal description
M12 female connector, 4-pin D-coded 	1	TX+	Transmit data positive
	2	RX+	Receive data positive
	3	TX-	Transmit data negative
	4	RX-	Receive data negative

CAN I/O

Table 3: Pin assignment for CAN I/O connection

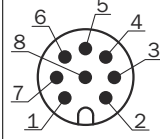
Male/female connector	Pin	Short form	Signal description
	1	CAN H	CAN high
	2	CAN L	CAN low
	3	IN2	Input 2
	4	GND IN1/2	Earth input 1/2
	5	OUT2	Output 2
	6	OUT3	Output 3
	7	GND	Earth
	8	OUT4	Output 4

Power

Table 4: Pin assignment Power connection

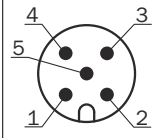
Male/female connector	Pin	Short form	Signal description
	1	L+	Supply voltage: +9 V DC ... +32 V DC
	2	IN1	Input 1
	3	GND	Earth
	4	OUT1	Output 1
	5	GND IN1/2	Earth input 1/2

6.3 Connection options

The following figures illustrate connection examples.

+24 V

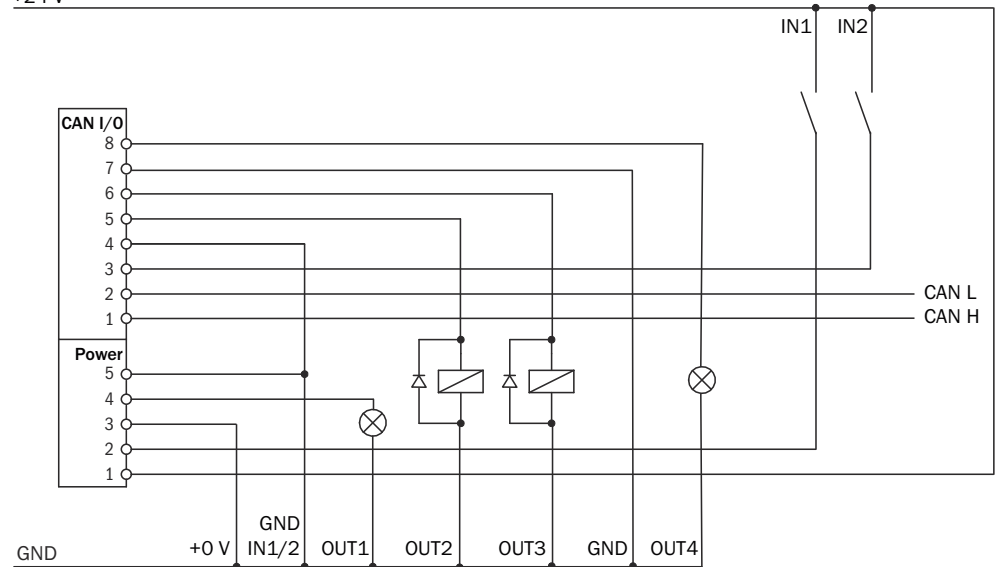

Figure 2: PNP outputs connection example

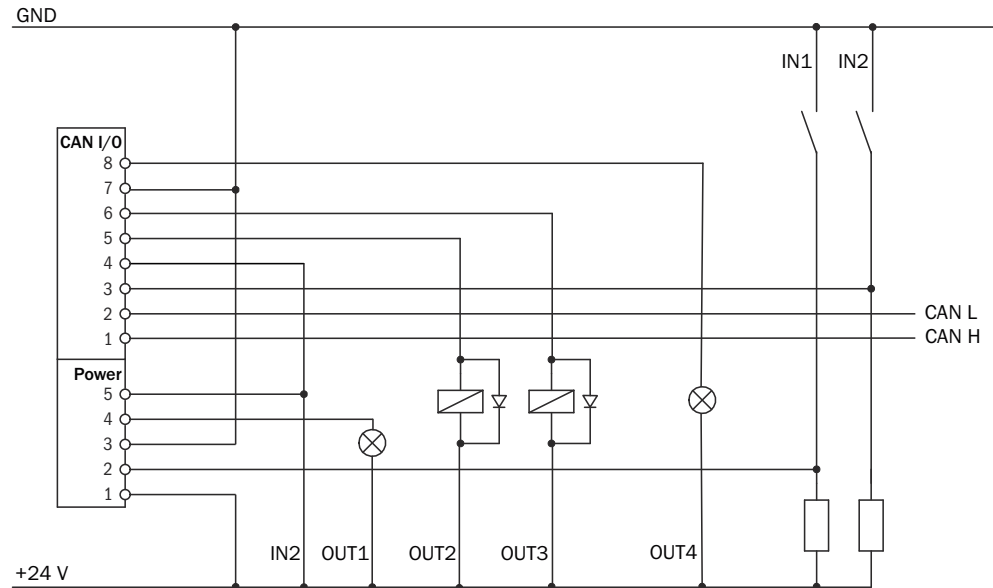

Figure 3: NPN outputs connection example

6.4 Connecting the device electrically

1. Ensure the voltage supply is not connected.
2. Connect the device according to the connection diagram, "[Connection diagram](#)", [page 15](#).
3. Switch on the supply voltage.

7 Operation

7.1 General advice

The device works fully automatically in normal operation and requires no operator intervention.

Configuration of the device is performed using the browser-based SOPASair software. The device must be connected to a computer via an interface for this purpose.

The measurement data and measuring ranges can be checked using the graphical view. Please note that the software cannot display the data in real time, therefore not all measured values that the device delivers will be displayed.

7.2 Switching off and on

1. To switch off the device, disconnect the device from the voltage supply.
 - ✓ The device switches off. The device configuration remains unchanged, measured values are lost.
2. Connect the device to the voltage supply.
 - ✓ The device starts with the last saved configuration data.

7.3 Operation using SOPASair

The browser-based SOPASair software can be used to parameterize the device and for service and diagnostic purposes.

To parameterize the device, you will require a computer with a web browser installed and a free Ethernet connection. Alternatively, the connection can be established via a USB connection using an Ethernet USB adapter.

7.3.1 Opening user interface

Before opening the user interface, perform the following work steps:

- Connect the device to the computer via Ethernet.
- Set up the voltage supply for the device.
- Ensure that the computer and device are located in the same network.
- Ensure that the computer uses a different IP address than the device.

Opening user interface:

1. Open web browser (recommendation: Google Chrome).
 2. Enter the device IP address into the address line. The standard IP address is:
192.168.0.1
- ✓ The SOPASair user interface is displayed.

7.3.2 Overview

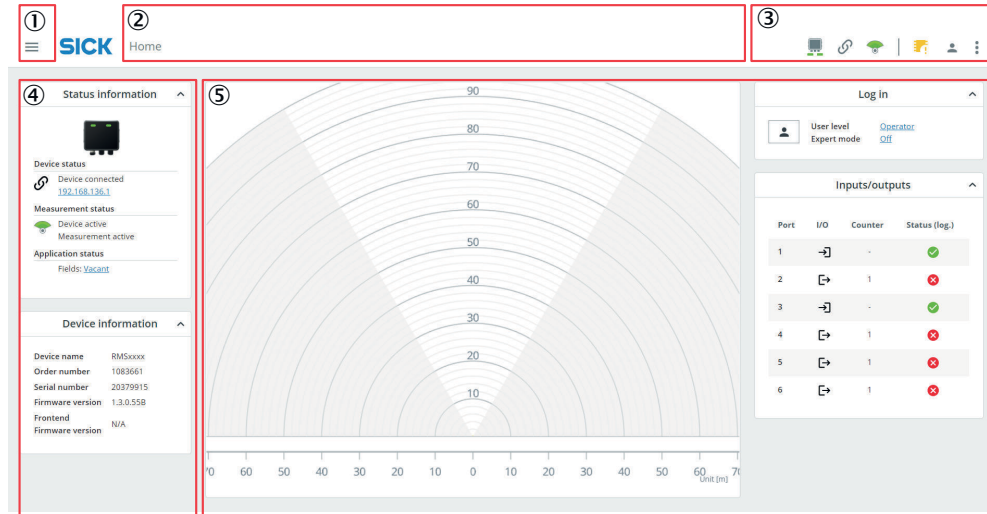

- ① Open and close the menu list.
- ② Displays the opened menu
- ③ Status indicators | toolbar
- ④ Status information and Device information menu panel
- ⑤ Workspace with scan view and menu panels

Status indicators



LED indication



Device connection status



Measurement status

Toolbar



Save permanently



Open login window



Change user interface language



Device menu

Navigation

1. Click on .
2. Click on the desired menu.
- ✓ The workspace changes depending on the selected menu.

7.3.3 Home

Status information

Function	Description
Device status	Displays the connection status. When a device is connected, the IP address is displayed. The IP address can be adapted if necessary.
Measurement status	The device status and the measurement status are displayed.
Application status	The application status is displayed.

Device information

Displays the device information.

Scan view

The scan view is a visualization of the working range. If fields have already been configured, detections are displayed and highlighted in color.







To show the legend details, click on the  button.

Table 5: Legend

Function	Icon (color)	Description
Objects	 (Dark blue)	Objects are detected and are above the sensitivity threshold. Device does not detect any objects in the field.
Filtered objects	 (Turquoise)	Objects are detected and are below the sensitivity threshold. Device does not detect any objects in the field.
Infringing objects	 (Orange)	Objects are detected and are above the sensitivity threshold. Device detects objects in the field.
Field ok	 (Light blue)	Device does not detect any objects in the field.
Field infringed	 (Yellow)	Device detects objects in the field.
Object properties		Show or hide measured values.

Log in

The device has different user levels.

The user levels have different authorizations for configuring the device.

The current user level is displayed in the **Log in** panel.

1. Click on the  button.
- ✓ The **Logging into the device** input screen is displayed.
2. Select **User levels**, enter **Password**.

User levels	Password	User and authorizations
Run	-	Customers: Display only, no configuration

User levels	Password	User and authorizations
AuthorizedClient	client	Technical staff: Install and configure device
Service		Service staff: Make advanced configuration settings

Inputs/outputs

Displays information on the configuration and the switching status of the digital inputs and digital outputs.

7.3.4 Configuration > Basic settings

Basic settings

Function	Description
Device name	Device name is displayed. Device name can be adapted in SOPASair.
Start angle, Stop angle	Set the horizontal working range (aperture angle). The detection limits can be defined separately for the left side (Start angle) and the right side (Stop angle).

Filter

Function	Description
Sensitivity filter	Activate and deactivate sensitivity filters.
Thresholds	Teach-in the current ambient data. The ambient data then used to automatically define the sensitivity thresholds. Ensure that there are no objects in the configured monitored area. Start the process by clicking on Teach in . Reset setting by clicking on Reset .

LED indication

Deactivate and activate the status indicators on the device.

Visualizing detection and setting sensitivity threshold

In the **Basic settings** menu, detections are displayed as blue rings in the scan view. The diagram next to the scan view shows the signal level relative to the distance values.

The sensitivity threshold can be set for individual distance ranges or for the entire working range. With a high sensitivity threshold, the device is less sensitive to object detection. If a low sensitivity threshold is set, the device reacts very sensitively during object detection.

The legend provides information on the type of object detection, [see "Home", page 20](#). Detections below the sensitivity threshold are displayed in turquoise in the diagram. Detections above the sensitivity threshold are displayed as blue rings in the scan view. If the detection is above the threshold but not in an applied field, it is displayed in dark blue in the diagram. If the detection is above the threshold and in an applied field, it is displayed in red in the diagram.

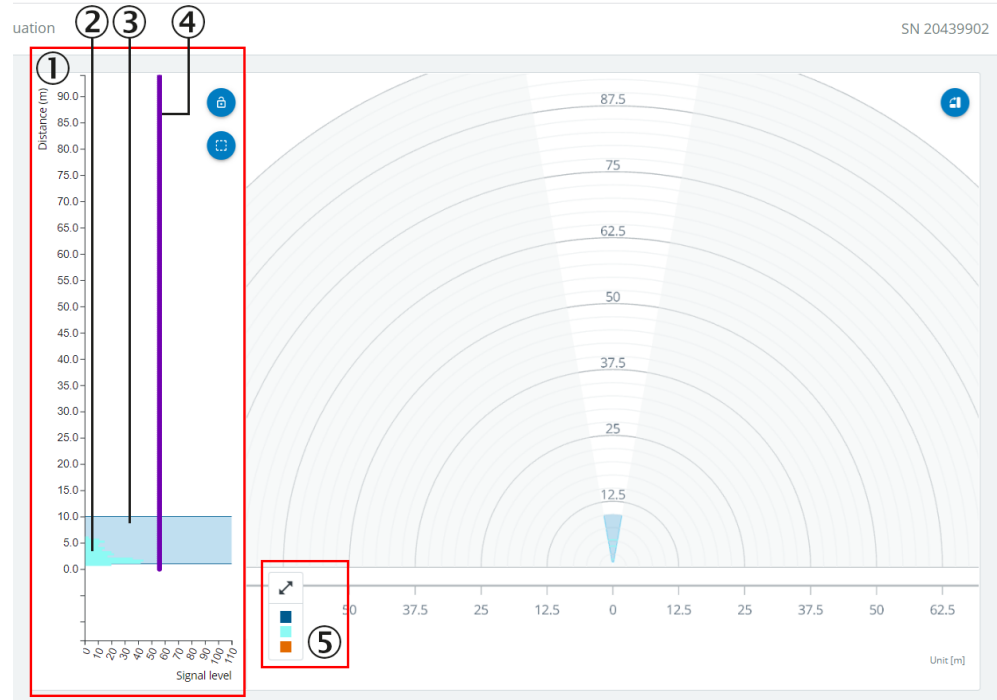

Figure 4: **Filtered objects (turquoise):** Detected object is below the sensitivity threshold

- ① Signal level relative to distance values
- ② Type of object detection
- ③ Field
- ④ Sensitivity threshold
- ⑤ Legend with information on the type of object detection

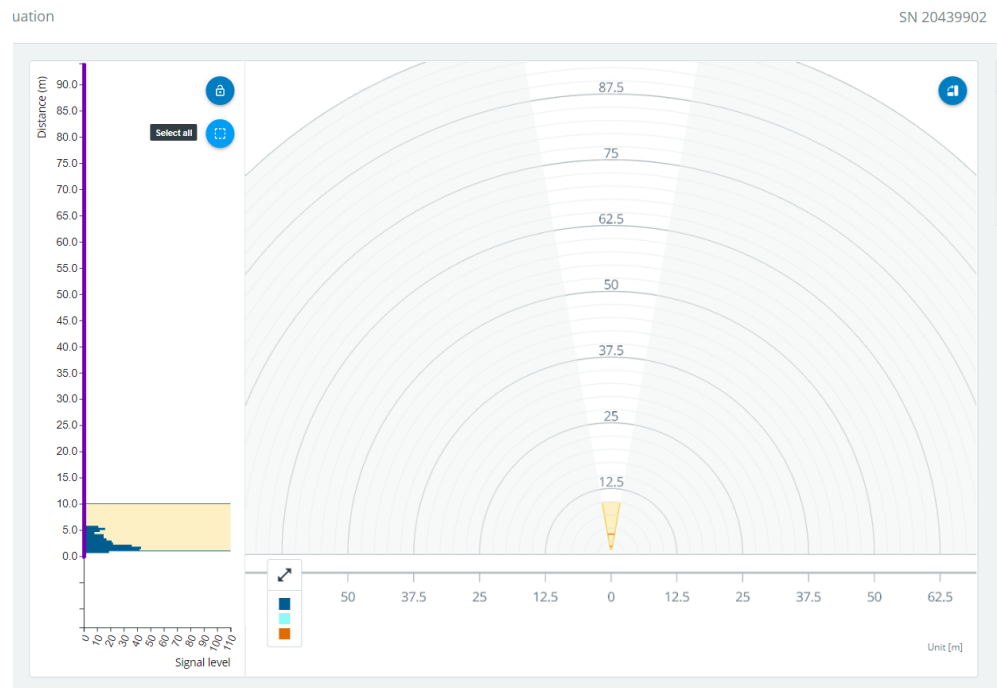

Figure 5: **Objects (dark blue):** Detected object is above the sensitivity threshold

7.3.5 Configuration > Connection options

Ethernet

Function	Description
DHCP, IP address, Subnet mask, Default gateway	Configure network address. Restart the device by clicking on the Accept button. SOPASair must then be opened with the new IP address of the device.
MAC address	Display the MAC address of the device.
Speed	Adjust the transmission speed
Calculated speed	Display the calculated transmission speed

UDP port

Function	Description
CoLa dialect	Set the telegram language
Port	Set the communication port

AUX port (monitoring)

Function	Description
CoLa dialect	Set the telegram language
Server / client	Configure the device as a "Server" or "Client"
Port	Set the communication port

Host port (parameterization)

Function	Description
CoLa dialect	Set the telegram language
Port	Set the communication port
Heartbeat	Deactivate and activate the setting of the communication interval
Heartbeat interval	Set communication interval
Heartbeat interval restart on send	Deactivate and activate restart of the communication interval

7.3.6 Application > Inputs/outputs

Function	Description
Port x	Configure digital inputs and digital outputs
Output mode	Select the output mode
Output counter	Reset event counter for digital outputs

7.3.7 Application > Field evaluation

Scan view

Visualizes the fields that are created in the **Field evaluation** panel.

The fields are visualized in the scan view and to the left of it in the diagram. Up to four fields can be generated. The fields can be connected to each other without gaps or separated from each other via spaces between the individual fields.

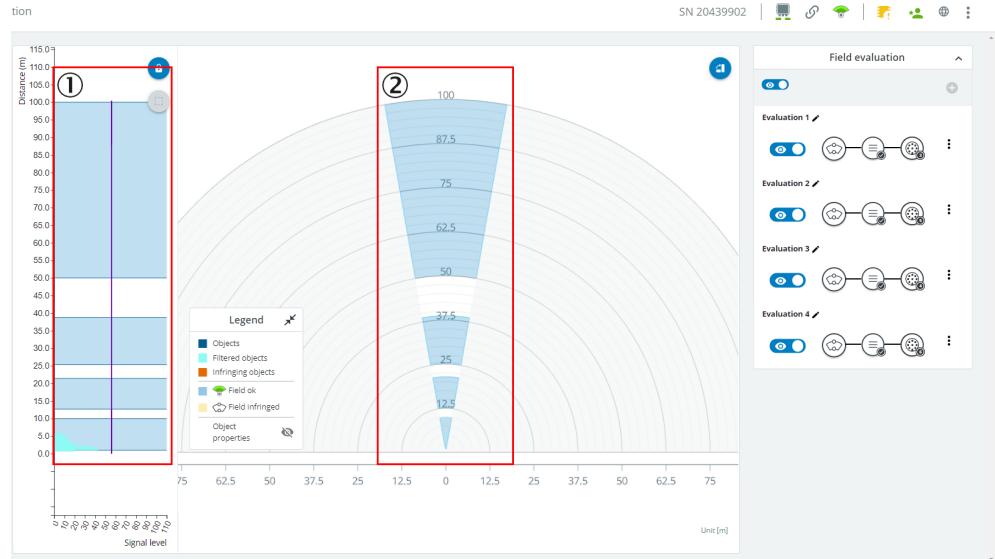

Figure 6: Visualization of the generated fields

- ① Diagram of signal strength relative to distance values with fields shown in blue
- ② Scan view with fields shown in blue

Field evaluation

Function	Description
	Deactivate and activate the visualization of the fields in the scan view
	Create a new field (maximum 4)
Field settings	Configure the field settings Enter the field name and the start and stop distance
Evaluation	Configure the evaluation criteria Configure the trigger criteria based on the direction of movement of the object Adjust the response time and holding time
Output properties	Specify the output settings
	Open submenu Delete field

7.3.8 Diagnostics > Overview

Displays status and operating information are displayed.

Function	Description
Status information	see "Home", page 20.
Operating information	Displays data on the device parameters.
Messages	Displays warning and error messages.

7.4 Operation in SOPAS ET

Execute the functions listed below via the SOPAS ET configuration software.

Functions

- Terminal program
- Install firmware updates
- Import and export data

The most up-to-date version of the SOPAS ET software can be downloaded from www.sick.com/software, category: **Configuration software**, software type: **SOPAS ET**.

7.5 RMS1000 terminal program

The terminal program is a component of the SOPAS ET software.

Terminal program description

The terminal program is started in the main window of SOPAS via the **Tools > Terminal** menu.

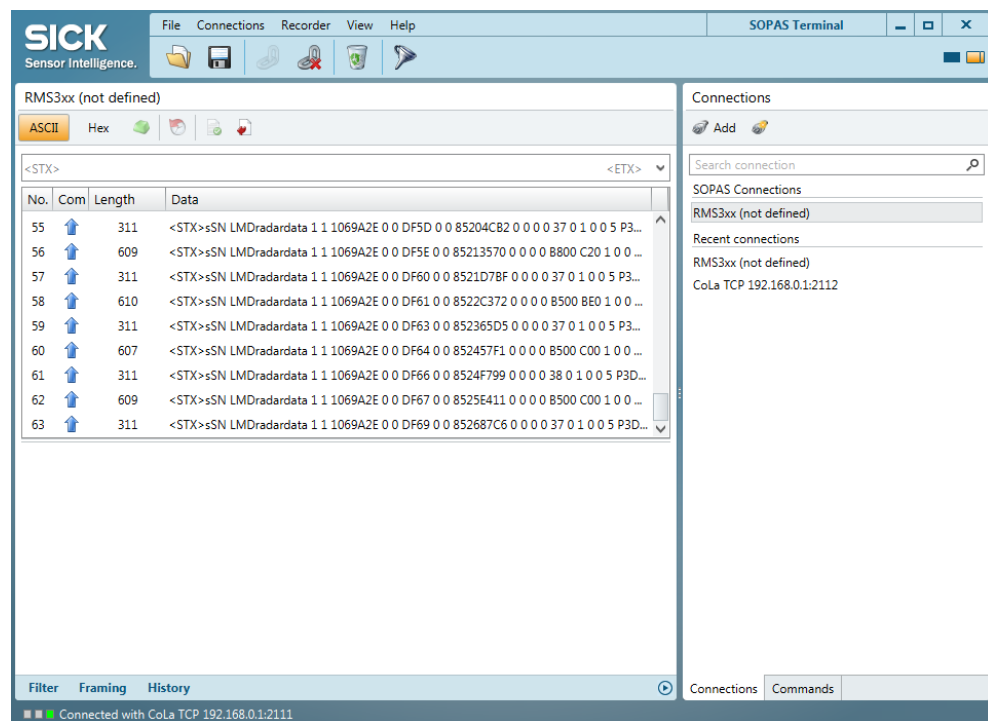

NOTE

A description of the telegrams can be found in the **Technical Information Telegram Listing RMS100** publication (English, no. 8026613).

8 Maintenance

8.1 Maintenance plan

During operation, the device works maintenance-free.

Depending on the assignment location, the following preventive maintenance tasks may be required for the device at regular intervals:

Table 6: Maintenance plan

Maintenance work	Interval	To be carried out by
Check device and connecting cables for damage at regular intervals.	Depends on ambient conditions and climate.	Specialist
Clean housing.	Depends on ambient conditions and climate. Recommended: Every 3 months.	Specialist
Check the screw connections and plug connectors.	Depends on the place of use, ambient conditions or operating requirements. Recommended: At least every 6 months.	Specialist
Check that all unused connections are sealed with protective caps.	Depends on ambient conditions and climate. Recommended: At least every 6 months.	Specialist

9 Troubleshooting

9.1 General faults, warnings, and errors

Possible faults and corrective actions are described in the table below for troubleshooting. For faults that cannot be rectified using the information below, please contact SICK Service. To find your agency, see the final page of this document.



NOTE

Before calling, make a note of all type label data such as type designation, serial number, etc., to ensure faster assistance.

Table 7: Fault table

Fault description	Possible causes	Troubleshooting
LEDs do not light up.	No voltage supply connected.	Connecting the voltage supply.
No connection between the software and the device.	Connection dropped.	Verify connections.
Objects are not detected.	Objects in the detection area.	Check the alignment of the detection area.
No switching signals are output via the I/O interface.	No detection signals present. Device configuration faulty. Bad connection.	Check alignment of the detection area, device configuration and connections.
No data is output via the Ethernet interface.	Device configuration faulty. Poor data connection.	Check device configuration and connections.

9.2 Repairs

Repair work on the device may only be performed by qualified and authorized personnel from SICK AG. Interruptions or modifications to the device by the customer will invalidate any warranty claims against SICK AG.

9.3 Returns

- ▶ Only send in devices after consulting with SICK Service.
- ▶ The device must be sent in the original packaging or an equivalent padded packaging.



NOTE

To enable efficient processing and allow us to determine the cause quickly, please include the following when making a return:

- Details of the contact person
- Description of the application
- Description of the fault that occurred

9.4 Disposal

If a device can no longer be used, dispose of it in an environmentally friendly manner in accordance with the applicable country-specific waste disposal regulations. Do not dispose of the product along with household waste.



NOTICE

Danger to the environment due to improper disposal of the device.

Disposing of devices improperly may cause damage to the environment.

Therefore, observe the following information:

- Always observe the national regulations on environmental protection.
 - Separate the recyclable materials by type and place them in recycling containers.
-

10 Technical data



NOTE

The relevant online data sheet for your product, including technical data, dimensional drawing, and connection diagrams can be downloaded, saved, and printed from the Internet:

- www.sick.com/RMS1000

Please note: This documentation may contain further technical data.

10.1 Features

Measurement principle	FMCW
Radio equipment approval	For country-specific restrictions see “Regulatory Compliance Information” (no. 8021596) technical information (downloads), also included with the product
Frequency band	61 GHz ... 61.5 GHz
Transmitting power	< 20 dBm (e.i.r.p.)
Aperture angle	Horizontal: ± 60° Vertical: ± 4°
Working range	0.4 m ... 100 m
Detection capability	At 1 m ² RCS ¹ : 50 m At 10 m ² RCS ² : 100 m
Distance accuracy	1 m ² RCS ¹ to 20 m: 0.04 m 1 m ² RCS ² to 50 m: 0.1 m
Distance resolution	0.4 m
Speed Range	-30 m/s ... +30 m/s
Speed resolution	0.625 m/s
Speed accuracy	1 m ² to 20 m: 0.0625 m/s 1 m ² to 50 m: 0.15 m/s

¹ Typical radar cross section value for a pedestrian.

² Typical radar cross section value for a car.

Working ranges based on distance

	Distance [m]							
	1	5	10	20	40	60	80	100
Vertical	0.1	0.7	1.4	2.8	5.6	8.4	11.2	14.0
Horizontal	3.5	17.3	34.6	69.3	138.6	207.8	277.1	346.4

10.2 Performance

Initialization time	Typically 20 seconds
Processing latency	1 measurement cycle
Measurement cycle duration	100 ms
Integrated application	Zone evaluation
Number of field sets	Up to 4 zones

10.3 Interfaces

Ethernet	✓, TCP/IP Function: parameterization, data output Data transmission rate: 10/100 Mbit
CAN	Remark: In preparation Protocol: SAE J1939
Digital inputs	2 (electrically isolated from the supply voltage, $U_e = \text{max. } 32 \text{ V DC}$, $I_e = \text{max. } 5 \text{ mA}$, opto-decoupled, reverse polarity protected, adjustable debounce time)
Digital outputs	4 (not electrically isolated from the supply voltage, PNP/NPN/PP configurable, $U_a = U_V - 1.5 \text{ V DC}$, $I_A \leq 200 \text{ mA}$ (typical), short-circuit protected, temperature protected)

10.4 Mechanics/electronics

Connection type	1 x M12 male connector, 8-pin, A-coded 1 x M12 male connector, 5-pin, A-coded 1 x M12 female connector, 4-pin, D-coded
Supply voltage	9 V DC ... 32 V DC
Power consumption	4 W (typical, without digital output load) Max. 36 W
Housing color	Grey (RAL 7042)
Enclosure rating	IP67 and IP69 (EN 60529: 1991-10 / A2: 2000-02) ¹
Protection class	III (EN 61140:2006-08)
Electrical safety	PS2 (EN 62368-1)
Weight	300 g
Dimensions (L x W x H)	34 mm x 97 mm x 96 mm

¹ In connected state with suitable mating plug or protective cap mounted on the connections.

Dimensional drawing

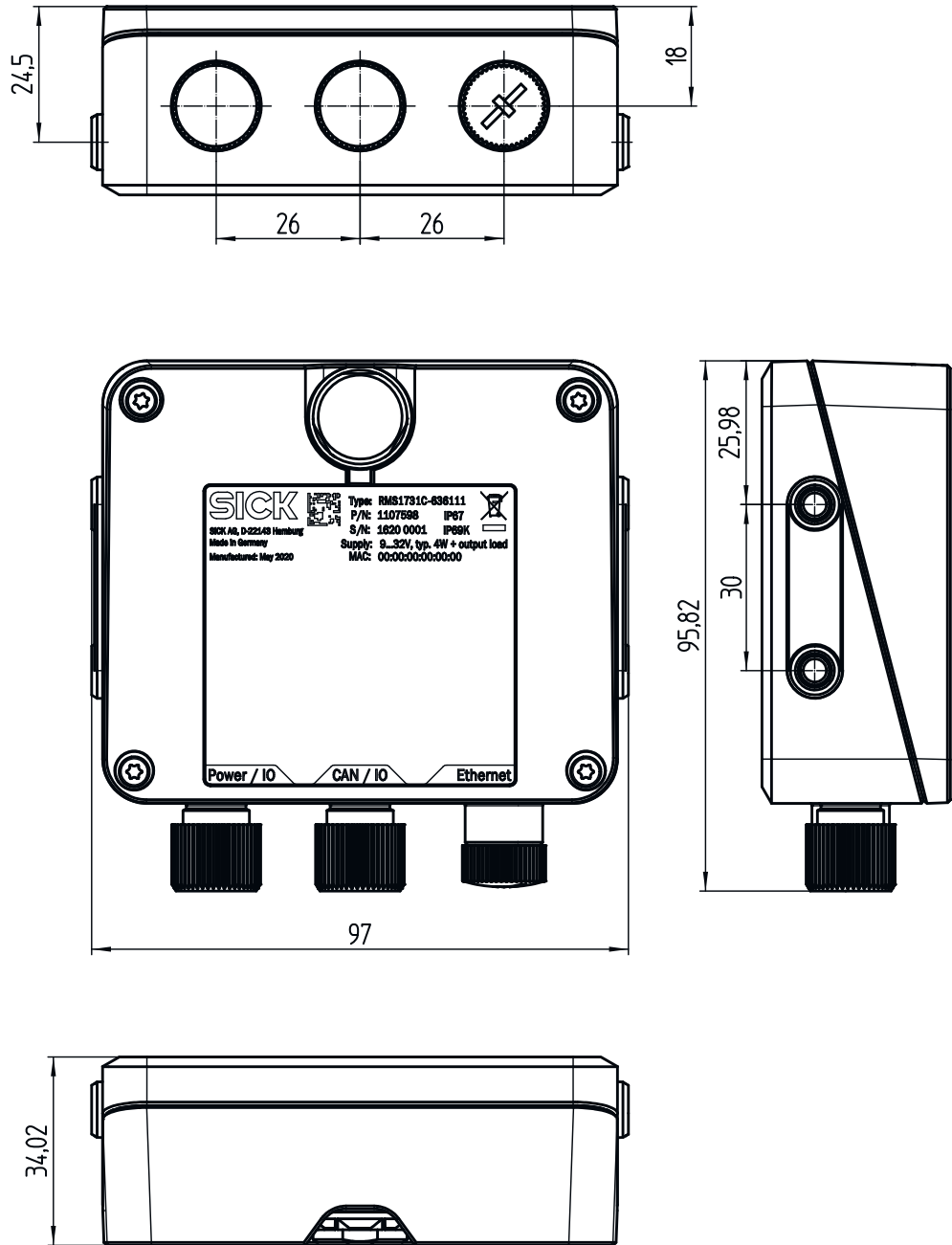

Figure 7: Dimensional drawing RMS1000

10.5 Ambient data

Electromagnetic compatibility (EMC)	ETSI EN 301 489-3 EN 61000-6-2 EN 61000-6-4
Radio standard	ETSI EN 305 550
Vibration resistance	EN 60068-2-6:2008-02
Shock resistance	EN 60068-2-27:2009-05
Ambient operating temperature	-40 °C ... +65 °C

10 TECHNICAL DATA

Storage temperature	-40 °C ... +85 °C
Ambient humidity	0% ... 90%, non-condensing

11 Accessories



NOTE

Accessories and where applicable mounting information can be found online at:

- www.sick.com/RMS1000
-

12 Annex

12.1 EU declaration of conformity/Certificates

The EU declaration of conformity and other certificates can be downloaded from the Internet at:

- www.sick.com/RMS1000

12.2 Cybersecurity

To protect against cybersecurity threats, it is necessary to continuously monitor and maintain a comprehensive and holistic cybersecurity concept. A suitable concept comprises organizational, technical, procedural, electronic, and physical levels of defense and provides suitable measures for different types of risks. SICK's products and solutions must be viewed as a component of this concept.

Information on Cybersecurity can be found at: www.sick.com/psirt.

12.3 Licenses

SICK uses open source software which is published by the rights holders under a free license. Among others, the following license types are used: GNU General Public License (GPL version 2, GPL version 3), GNU Lesser General Public License (LGPL), MIT license, zlib license and licenses derived from the BSD license.

This program is provided for general use without warranty of any kind. This warranty disclaimer also extends to the implicit assurance of marketability or suitability of the program for a particular purpose.

More details can be found in the GNU General Public License. View the complete license texts here: www.sick.com/licensetexts. Printed copies of the license texts are also available on request.

Australia

Phone +61 (3) 9457 0600
1800 33 48 02 – tollfree
E-Mail sales@sick.com.au

Austria

Phone +43 (0) 2236 62288-0
E-Mail office@sick.at

Belgium/Luxembourg

Phone +32 (0) 2 466 55 66
E-Mail info@sick.be

Brazil

Phone +55 11 3215-4900
E-Mail comercial@sick.com.br

Canada

Phone +1 905.771.1444
E-Mail cs.canada@sick.com

Czech Republic

Phone +420 234 719 500
E-Mail sick@sick.cz

Chile

Phone +56 (2) 2274 7430
E-Mail chile@sick.com

China

Phone +86 20 2882 3600
E-Mail info.china@sick.net.cn

Denmark

Phone +45 45 82 64 00
E-Mail sick@sick.dk

Finland

Phone +358-9-25 15 800
E-Mail sick@sick.fi

France

Phone +33 1 64 62 35 00
E-Mail info@sick.fr

Germany

Phone +49 (0) 2 11 53 010
E-Mail info@sick.de

Greece

Phone +30 210 6825100
E-Mail office@sick.com.gr

Hong Kong

Phone +852 2153 6300
E-Mail ghk@sick.com.hk

Hungary

Phone +36 1 371 2680
E-Mail ertekezes@sick.hu

India

Phone +91-22-6119 8900
E-Mail info@sick-india.com

Israel

Phone +972 97110 11
E-Mail info@sick-sensors.com

Italy

Phone +39 02 27 43 41
E-Mail info@sick.it

Japan

Phone +81 3 5309 2112
E-Mail support@sick.jp

Malaysia

Phone +603-8080 7425
E-Mail enquiry.my@sick.com

Mexico

Phone +52 (472) 748 9451
E-Mail mexico@sick.com

Netherlands

Phone +31 (0) 30 229 25 44
E-Mail info@sick.nl

New Zealand

Phone +64 9 415 0459
0800 222 278 – tollfree
E-Mail sales@sick.co.nz

Norway

Phone +47 67 81 50 00
E-Mail sick@sick.no

Poland

Phone +48 22 539 41 00
E-Mail info@sick.pl

Romania

Phone +40 356-17 11 20
E-Mail office@sick.ro

Russia

Phone +7 495 283 09 90
E-Mail info@sick.ru

Singapore

Phone +65 6744 3732
E-Mail sales.gsg@sick.com

Slovakia

Phone +421 482 901 201
E-Mail mail@sick-sk.sk

Slovenia

Phone +386 591 78849
E-Mail office@sick.si

South Africa

Phone +27 10 060 0550
E-Mail info@sickautomation.co.za

South Korea

Phone +82 2 786 6321/4
E-Mail infokorea@sick.com

Spain

Phone +34 93 480 31 00
E-Mail info@sick.es

Sweden

Phone +46 10 110 10 00
E-Mail info@sick.se

Switzerland

Phone +41 41 619 29 39
E-Mail contact@sick.ch

Taiwan

Phone +886-2-2375-6288
E-Mail sales@sick.com.tw

Thailand

Phone +66 2 645 0009
E-Mail marcom.th@sick.com

Turkey

Phone +90 (216) 528 50 00
E-Mail info@sick.com.tr

United Arab Emirates

Phone +971 (0) 4 88 65 878
E-Mail contact@sick.ae

United Kingdom

Phone +44 (0)17278 31121
E-Mail info@sick.co.uk

USA

Phone +1 800.325.7425
E-Mail info@sick.com

Vietnam

Phone +65 6744 3732
E-Mail sales.gsg@sick.com

Detailed addresses and further locations at www.sick.com