

1. PRECAUTION

Please read through this Manual before use of the instrument for correct handling. Please keep this Manual carefully after use. This instrument has been thoroughly tested at the factory before shipment. When you receive it, visually inspect it for damage and check the accessories.

- ① Model number and specifications check
Check to see model number and specifications on the plate attached to side face of the repeater are as ordered.
- ② Contents of the instruction manual
This instruction manual provides instructions on handling, external wiring and safety use of the repeater.

2. GENERAL

This compact plug-in type repeater receives contact pulse, voltage pulse or current pulse from the field and converts it into isolated transistor contact pulse or dry contact AC switch pulse.

Accessories :

Tag Number Label 1

3. MOUNTING METHOD

JUXTA VJ Series Transmitters can be mounted on wall, DIN rail or multi-mounting base.

NOTE: Direction of insertion/extraction
Insertion/extraction of main body into and from socket should be done in vertical direction against face of socket.
Slanting insertion or extraction makes terminals bent causing bad contact with socket.

3.1 Wall Mounting

Loosen the socket's fixing screw as shown in Fig. 1 and pull out the main body from socket. Then fix the socket on the wall with screws. See Fig. 3 for mounting method.

3.2 DIN rail mounting

Insert DIN rail into the upper of the DIN rail groove on rear of socket of the repeater and fix the rail with slidlock at the lower of the repeater as shown in Fig.2.

3.3 Multi-base mounting

As for multi-base mounting, refer to Instruction Manual for VJCE (VJ mounting base).

3.4 Duct Installation

Install ducts, if necessary, aparting from top and bottom of the repeater more than 30mm.

4. EXTERNAL WIRING

CAUTION Wiring should be done after ensuring power break of cable.

See Fig.4 for terminal arrangement and Fig.5 for wiring.

Wiring should be done to M3 screw terminals of the socket.

Use round crimp-on terminals for connection to terminals.

FIG.1 WALL MOUNTING

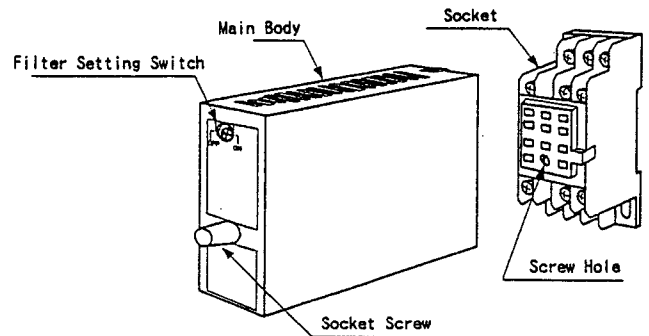

FIG.2 DIN RAIL MOUNTING

When remove the repeater from DIN Rail, lower the slidlock with (-) screwdriver

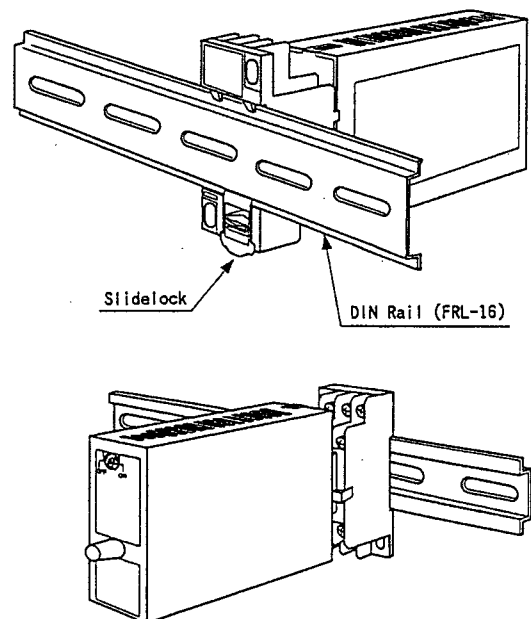
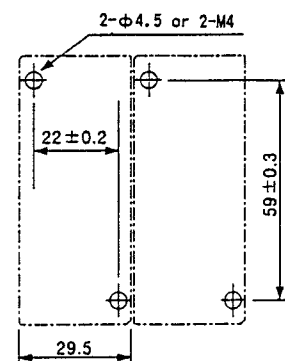

FIG.3 MOUNTING DIMENSION



Unit : mm

● Signal cable having more than 0.5mm² and power cable having more than 1.25mm² of nominal cross-sectional area of conductor are recommended to be used.

4.1 Wiring

In case of 2 output type

- ① Connect input signal cable to 1(PS+), 3(+), 4(-) of the repeater.
- ② Connect Output-1 signal cable to 7(+), 9(-).
- ③ Connect Output-2 signal cable to 2(+), 5(-).
- ④ Connect power cable to 8(GND), 10(L+), 11(N-).

NOTE : Apart wiring of power cable and input/output cable from noise source. Otherwise, accuracy may not be warranted.

5. INPUT FILTER SETTING

If there is noise in input voltage (or current), set front rotary switch at ON. Input filter of time constant about 10ms would be connected.

6. INSTALLATION AND HANDLING

- ① Avoid installation in such environments as shock, vibration, corrosive gas, dust, water, oil, solvent, direct sunlight, radiation, powerful electric and magnetic fields.
- ② In order to protect repeater from inducement of thunder surges in power and signal cables, use arrester between repeater and equipment installed in the field.

7. SAFETY USE

Following caution for safety should be taken for handling of the repeater. We are not responsible for damage caused by use contrary to caution.

CAUTION

- When install the main body, fix it to the socket with screws after inserting it into socket.
- Following items should be checked before power on. Use of the repeater by ignoring the specifications may cause overheating and burning.
 - (a) Voltage of power supply and input signal be applied to the repeater should meet with required specifications.
 - (b) External wiring to terminals should be connected correctly (See Article 4).
- Do not use the repeater in such dangerous places where exist inflammable and explosive gas or steam.

8. MAINTENANCE

Carry out the following calibration after warmup the repeater for more than 10~15 minutes to satisfy its specified performance.

8.1 Calibration Equipment

- Pulse Generator 1
(Yokogawa Type FG300 or equivalent)
- Counter or Oscilloscope 1
(Japan Hewlett-Packard Type 5334B or equivalent)
- Resistor and battery
(1k Ω , 1.6k Ω , ... 1 each; 6V dry cell .. 1)

8.2 Calibration

- ① Connect each equipment as shown in Fig.6
- ② Input/output characteristic check
First, check Output-1 and then check Output-2. Generate less than 10kHz optional frequency rectangle waveform pulse through Pulse Generator. (dot line in the chart shows connection to counter or oscilloscope)
- ③ Then, connect counter to 7, 9 or 2, 5 terminals. Check to see same frequency pulse from Pulse Generator is output.
If oscilloscope is used, check to see output pulse waveform is well shaped.

FIG. 4 TERMINAL ARRANGEMENT & TERMINAL CONNECTION

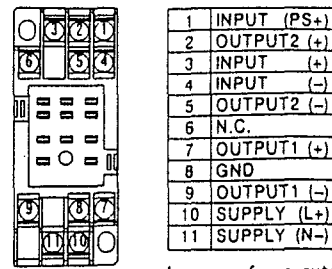

In case of one output type, OUTPUT2 is N.C.

FIG. 5 WIRING

Wiring for 2 outputs type

- (1) To receive dry voltage contact or voltage pulse
(However, in case of voltage pulse, 3 is + and 4 is -)

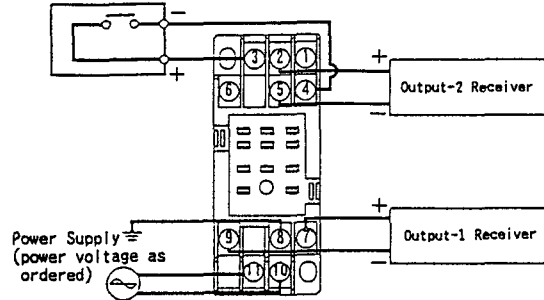

- (2) To receive current pulse driving generator by internal power supply (Input Section only)
- (3) To receive voltage pulse driving generator by internal power supply (Input Section only)

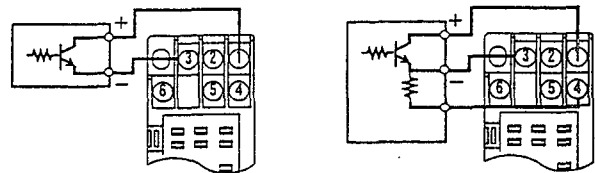
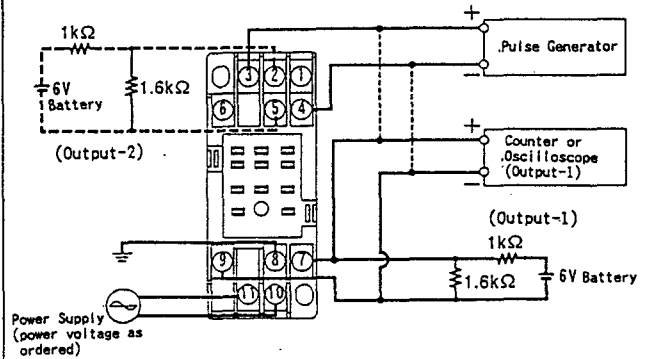

FIG. 6 WIRING OF CALIBRATION EQUIPMENT

Wiring for 2 outputs type



Subject to change without notice for grade up quality and performance.