

# MARSIC200

## Ship Emission Measuring Device

Installation and Initial Start-up

**SICK**  
Sensor Intelligence.



---

**Described product**

MARSIC200

**Manufacturer**

SICK AG  
Erwin-Sick-Str. 1  
79183 Waldkirch  
Germany

**Legal information**

This work is protected by copyright. Any rights derived from the copyright shall be reserved for SICK AG. Reproduction of this document or parts of this document is only permissible within the limits of the legal determination of Copyright Law. Any modification, abridgment or translation of this document is prohibited without the express written permission of SICK AG.

The trademarks stated in this document are the property of their respective owner.

© SICK AG. All rights reserved.

**Original document**

This document is an original document of SICK AG.



## Contents

<b>1</b>	<b>About this document.....</b>	<b>6</b>
1.1	Function of this document.....	6
1.2	Target group.....	6
1.3	Further information.....	6
1.4	Symbols and document conventions.....	6
1.4.1	Warning symbols.....	6
1.4.2	Warning levels / Signal words.....	7
1.4.3	Information symbols.....	7
<b>2</b>	<b>Installation.....</b>	<b>8</b>
2.1	Gas supply terminology.....	8
2.2	Installation information.....	8
2.2.1	Power supply information.....	8
2.2.2	Notes on the gas supply.....	8
2.2.3	Tube screw fitting.....	9
2.3	Scope of delivery.....	10
2.4	Provision by operator.....	10
2.5	Installation overview.....	11
2.5.1	System layout for 1 ... 4 measuring points.....	13
2.6	Checklist for mechanical and electrical installation.....	15
2.6.1	Installing the enclosure.....	15
2.6.2	Laying and connecting the gas lines.....	15
2.6.3	Lay and connect the electric lines between sampling probe with sample conditioning and distribution unit.....	16
2.6.4	Lay and connect the electric line between distribution unit and analyzer.....	19
2.7	Installing the sampling probe.....	21
2.8	Installing the sample gas line.....	22
2.9	Installing the sample conditioning.....	24
2.9.1	Fitting the sample conditioning.....	24
2.9.2	Gas connections on sample conditioning .....	25
2.9.3	Electrical installation of sample conditioning.....	27
2.10	Installing the distribution unit.....	27
2.10.1	Fitting the distribution unit.....	29
2.10.2	Gas connections on distribution unit.....	30
2.10.3	Electrical installation of distribution unit.....	31
2.10.4	Measuring point switchover.....	32
2.11	Installing the analyzer.....	33
2.11.1	Fitting the analyzer.....	34
2.11.2	Gas connections on analyzer.....	34
2.11.3	Electrical installation of analyzer.....	35
<b>3</b>	<b>Initial start-up.....</b>	<b>36</b>
3.1	Initial start-up.....	36

<b>4</b>	<b>Configuration software.....</b>	<b>38</b>
4.1	Software SOPAS ET.....	38
4.2	Passwords.....	38
<b>5</b>	<b>Adjustment functions.....</b>	<b>39</b>
5.1	Configuring test gases (Test Gas Table).....	39
5.2	Performing a manual adjustment.....	41
5.3	Automatic adjustments/validations.....	44
5.3.1	Function of automatic adjustments/validations.....	45
5.3.2	Start options.....	45
5.3.3	Programming automatic adjustments/validations.....	45
<b>6</b>	<b>Tests and settings.....</b>	<b>47</b>
6.1	Information.....	47
6.2	Setting the time.....	47
6.3	Interfaces (I/O).....	47
6.3.1	Digital inputs.....	47
6.3.2	Digital outputs.....	48
6.3.3	Analog outputs.....	49
6.4	Adapting the hardware.....	49
6.4.1	Setting analog interfaces.....	50
6.5	Configuring measured values.....	50
6.6	Measuring points - automatic.....	52
6.6.1	Function of the measuring points automatic.....	52
6.6.2	Criteria for measuring point automatic.....	52
6.6.3	Configuring measuring point automatic.....	53
6.7	Backup of settings.....	53
<b>7</b>	<b>Technical data.....</b>	<b>55</b>
7.1	Dimensional drawings.....	55
7.1.1	Dimensional drawing of sample conditioning.....	55
7.1.2	Dimensional drawing of distribution unit.....	56
7.1.3	Dimensional drawing of analyzer.....	57
7.1.4	Dimensional drawing of sampling probe.....	58
7.1.5	Sample gas line, heated.....	58
7.2	Gas flow diagram.....	59
7.3	Measuring parameters.....	61
7.4	Ambient conditions.....	61
7.5	Sample gas conditions.....	62
7.6	Design as wall enclosure.....	62
7.7	Sample gas line, heated.....	63
7.8	Interfaces and protocols.....	63
7.9	Energy supply.....	64
7.10	Emissions.....	65
7.11	Torques for screw fittings.....	65
7.12	Tube connections.....	66

7.13 Sample gas conditions..... 66

## 1 About this document

### 1.1 Function of this document

This document describes:

- Installation
- Initial start-up
- Operation via SOPAS ET



#### NOTICE

This Manual is only valid in combination with the MARSIC Operating Instructions.

---

### 1.2 Target group

This document is addressed to technicians (persons with technical understanding) operating and maintaining the measuring system.

The technicians must have been trained on the device.

#### Requirements for the technician

- The technician must be familiar with the exhaust gas technology on the ship (over-pressure, toxic and hot flue gases) and be able to avoid hazards when working on gas ducts.
- The technician must be familiar with handling compressed gas cylinders (test gases).
- The technician must be able to avoid hazards caused by noxious test gases.
- Only allow an authorized electrician to work on the electrical system or electrical subassemblies.

### 1.3 Further information







- “MARSIC200” Operating Instructions
- Sampling Probe Operating Instructions
- Instructions for laying the sample gas line
- Sample Gas Cooler Operating Instructions
- GMS800 BCU Operating Instructions
- GMS800 Technical Information
- Optional: MPR (Meeting Point Router) Operating Instructions
- System documentation (parts list, device data, wiring diagram, system-relevant components)

### 1.4 Symbols and document conventions

#### 1.4.1 Warning symbols

Table 1: Warning symbols

Symbol	Significance
	Hazard (general)
	Hazard by voltage

Symbol	Significance
	Hazard in potentially explosive atmospheres
	Hazard by explosive substances/mixtures
	Hazard by toxic substances
	Hazards by noxious substances
	Hazard by high temperature
	Hazard for the environment/nature/organic life

**1.4.2 Warning levels / Signal words**

**DANGER**

Risk or hazardous situation which will result in severe personal injury or death.

**WARNING**

Risk or hazardous situation which could result in severe personal injury or death.

**CAUTION**

Hazard or unsafe practice which could result in less severe or minor injuries.

**Notice**



Hazard which could result in property damage.

**Note**

Hints

**1.4.3 Information symbols**

*Table 2: Information symbols*

Symbol	Significance
	Important technical information for this product
	Important information on electric or electronic functions

## 2 Installation

### 2.1 Gas supply terminology

Definition of the gases used:

- Zero gas: Gas used to adjust the zero point. Instrument air or nitrogen (N<sub>2</sub>).
- Span gas: Gas used to adjust the upper measuring range value.
- Test gas: Generic term for zero and span gas.
- Instrument air: Clean compressed air.

Quality of gases: see "Sample gas conditions", page 66.

### 2.2 Installation information

#### 2.2.1 Power supply information

The operator is responsible for correct laying and connection of the electric lines.



#### WARNING

Danger to life by electric voltage

- ▶ Only allow an authorized electrician to work on the electric system



#### ATTENTION

Observe 115 V or 230 V versions.

The following subassemblies have a 115 V or 230 V version:

- Sample gas line
- Sample gas pump (in distribution unit)
- Cooler (in sample conditioning)
- Analyzer

Check that the voltage on the type plate matches the power supply.

When selecting and laying the electric lines for power supply, observe the technical data (see "Energy supply", page 64) and the applicable local standards and guidelines.

#### 2.2.2 Notes on the gas supply

The operator is responsible for the correct laying of the sample gas lines.



#### ATTENTION

Risk of contamination of the analyzer by unclean instrument air.

- ▶ Only use instrument air corresponding to the prescribed specification (see Technical Data).
- ▶ Install a suitable instrument air conditioning when necessary.

Gas	Quality	Inlet pressure	Flow rate
Instrument air	Particle size max. 1 µm Oil content max. 0.1 mg/m <sup>3</sup>	Max. +300 hPa	Typically 60 l/h
Zero point gas	Nitrogen 5.0	Max. +300 hPa	Typically 60 l/h



Gas	Quality	Inlet pressure	Flow rate
Span gas	External span gas Precision: ± 2 % Concentration: 80% ... 100% of measuring range The span gas must comply with the specifications of the standards to be applied (e.g., MARPOL Annex VI)	Max. +300 hPa	Typically 60 l/h

Flow plan see "Gas flow diagram", page 59

Dimension of connections of PTFE tubes: DN4/6.

The operator is responsible for the correct laying of the sample gas lines.

Observe the enclosed information concerning the laying of the heated sample gas line.



**CAUTION**

The PTFE tubes are susceptible to kinks.

- ▶ Lay PTFE tubes in large arcs and plan a kink protection as necessary.
- ▶ Observe the clearances when fitting the enclosures: see "Dimensional drawings", page 55.

**2.2.3 Tube screw fitting**

**Swagelok screw fitting**

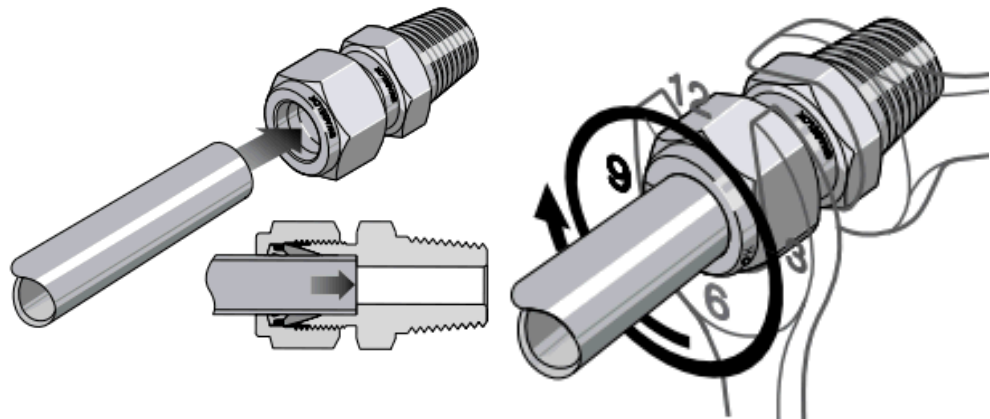

- ▶ Push the tube up to the stop in the tube screw fitting.  
Turn the cap nut finger-tight.
- ▶ During initial assembly: Hold the fitting bolt steady and tighten the cap nut with 1 1/4 revolutions.
- ▶ During refitting: Tighten the cap nut to the previous position (the resistance increases noticeably) and then slightly tighten.

**Plastic fitting**

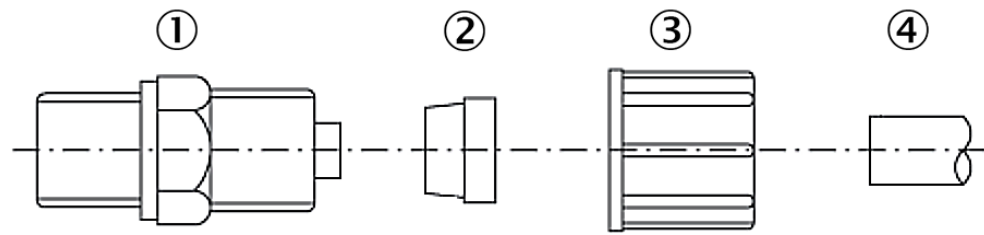
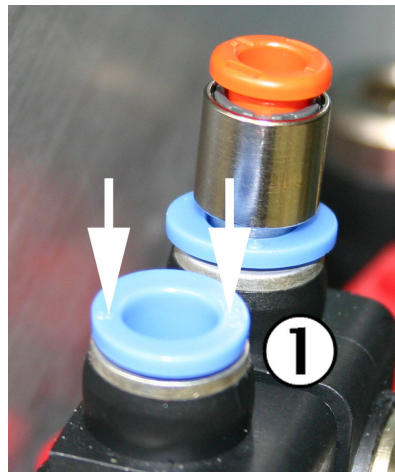

Figure 1: Hose fitting

- ① Screw-in piece
- ② Clamping ring
- ③ Knurled nut
- ④ Hose

- ▶ Place the knurled nut and the clamping ring on the hose. Observe the location of the clamping ring (see drawing).
- ▶ Place the hose on the screw-in piece.
- ▶ Turn the knurled nut hand-tight.

**Push-in fitting pneumatic**



- ① Retaining ring

- ▶ Inserting the tube: Push the tube in.
- ▶ Removing the tube: Press the retaining ring in and pull the tube out.

**2.3 Scope of delivery**

Please see the delivery documents for the scope of delivery.

**2.4 Provision by operator**

**To be provided by operator:**

- Fixing accessories of enclosures (dowels, screws, etc.)
- PTFE tubes and screw fittings: Depending on order
- Grounding conductor for analyzer
- Fixing accessories for heated sample gas line
- Fixing accessories for PTFE tubes
- Nitrogen or instrument air as zero gas: Observe the required quality: [see "Sample gas conditions", page 66](#)

## 2.5 Installation overview

**NOTE**  
Gas flow diagram see "Gas flow diagram", page 59

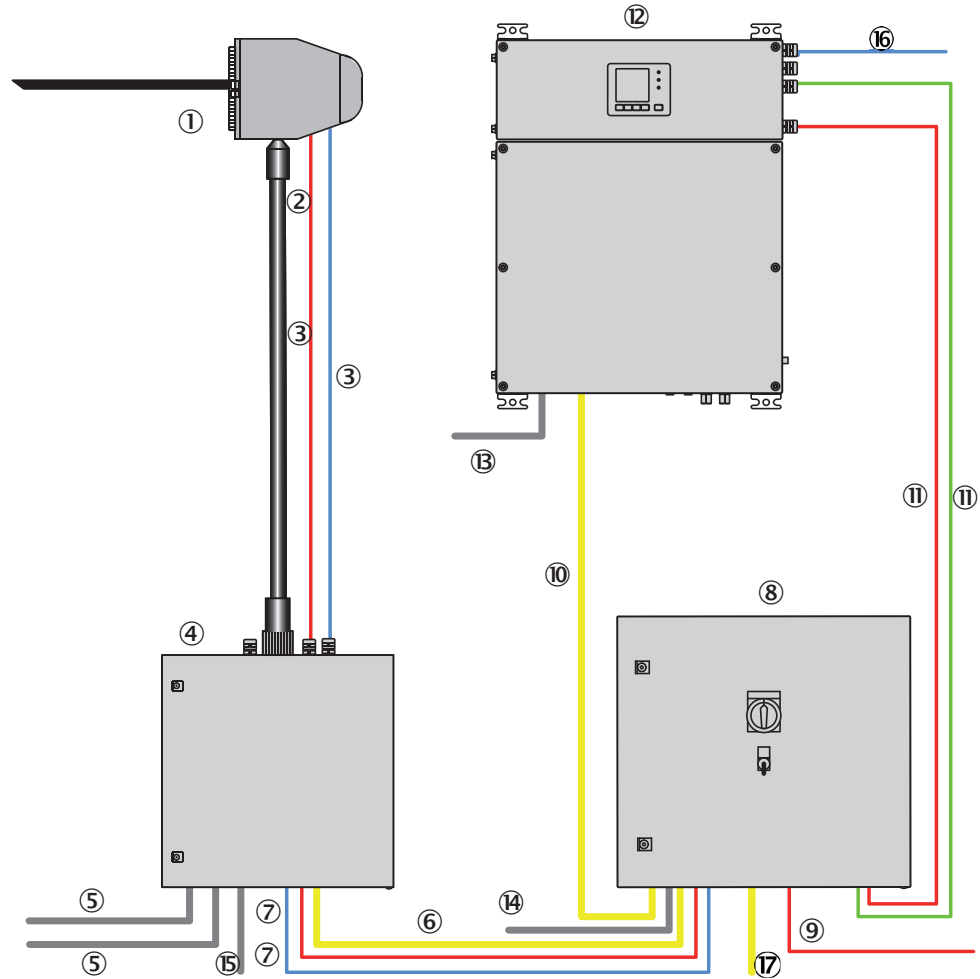

Figure 2: Installation - overview

Red Power supply  
Blue and green Signal line  
Yellow PTFE gas line

①	Heated sampling probe with: <ul style="list-style-type: none"> <li>• Sampling tube</li> <li>• Sample gas filter</li> <li>• Backflushing</li> </ul>
②	Heated sample gas line, sampling probe - sample conditioning: <ul style="list-style-type: none"> <li>• Sample gas</li> <li>• Instrument air/test gas (optional)</li> </ul>
③	Lines, sampling probe - sample conditioning <ul style="list-style-type: none"> <li>• Power supply of the sampling probe</li> <li>• Signal line</li> </ul>

④	<p>Sample conditioning with:</p> <ul style="list-style-type: none"> <li>● Sample gas cooler</li> <li>● Solenoid valve for feeding instrument air/test gas to the sampling probe</li> </ul>
⑤	<p>Gas inlets of sample conditioning:</p> <ul style="list-style-type: none"> <li>● Instrument air to backflush the probe</li> <li>● Only possible for measuring point 1: Test gas for adjustment via probe (optional)</li> </ul>
⑥	Unheated sample gas line, sample conditioning - distribution unit
⑦	<p>Lines, sample conditioning - distribution unit:</p> <ul style="list-style-type: none"> <li>● Power supply of sample conditioning</li> <li>● Signal line</li> </ul>
⑧	<p>Distribution unit with:</p> <ul style="list-style-type: none"> <li>● Power supply, complete system with central power distribution</li> <li>● System fuses</li> <li>● Main switch</li> <li>● "Stand-by" switch</li> <li>● Flow indicator</li> <li>● Sample gas fine filter</li> <li>● Water trap</li> <li>● Sample gas pump</li> <li>● Sample gas valve (test gas feed optional)</li> <li>● Measuring point switchover (for 2 ... 4 measuring points)</li> <li>● Bypass pump (for 2 ... 4 measuring points)</li> </ul>
⑨	<p>Inlet for central power supply for the complete system</p> <ul style="list-style-type: none"> <li>● The distribution unit provides electrical power for all system modules.</li> </ul>
⑩	Unheated sample gas line from distribution unit to analyzer
⑪	<p>Lines, distribution unit - analyzer:</p> <ul style="list-style-type: none"> <li>● Analyzer power supply</li> <li>● Signal lines</li> </ul>
⑫	<p>Analyzer</p> <ul style="list-style-type: none"> <li>● Control unit</li> <li>● Measuring modules: <ul style="list-style-type: none"> <li>○ Gas module (flow, humidity and pressure)</li> <li>○ DEFOR (NO, NO<sub>2</sub> and SO<sub>2</sub>)</li> <li>○ FINOR (CO<sub>2</sub>)</li> <li>○ OXOR (O<sub>2</sub>), option</li> </ul> </li> <li>● Analog and digital interfaces</li> <li>● Ethernet</li> </ul>
⑬	Sample gas outlet
⑭	<p>Test gas inlet</p> <p>Test gas connection during adjustment</p>
⑮	Condensate outlet
⑯	Signal lines/Ethernet to periphery

2.5.1 System layout for 1 ... 4 measuring points

1 measuring point



- Red Power (3x1.5; Order no: 6056215)
- Blue Signal (4x0.75; Order no: 6056229)
- Green Signal (7x1.5; Order no: 6056230)
- Yellow PTFE line (4/6; Order no: 5310243)

2 measuring points

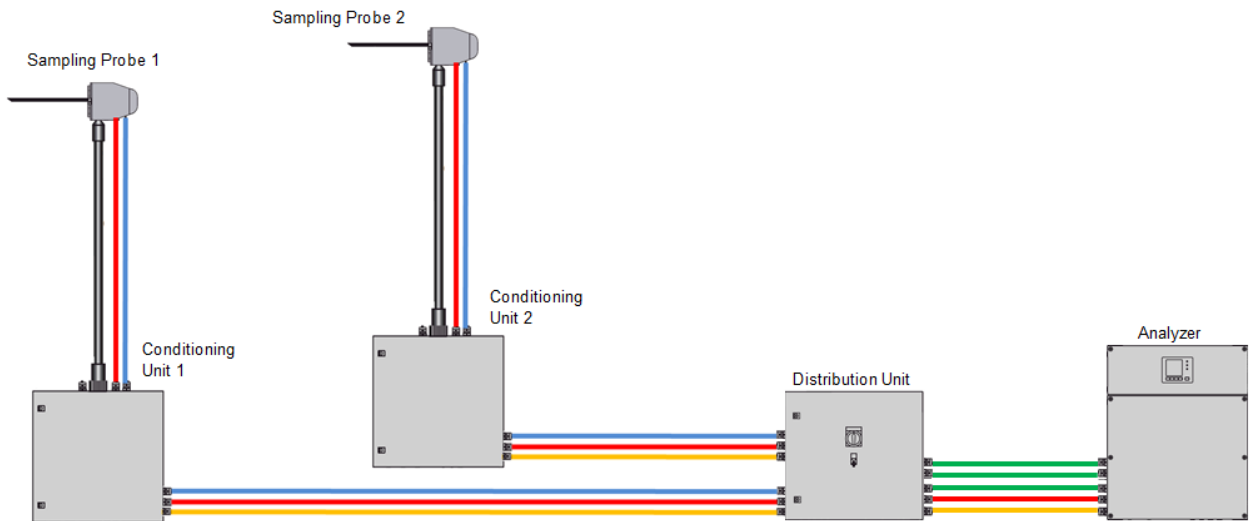

- Red Power (3x1.5; Order no: 6056215)
- Blue Signal (4x0.75; Order no: 6056229)
- Green Signal (7x1.5; Order no: 6056230)
- Yellow PTFE line (4/6; Order no: 5310243)

3 measuring points

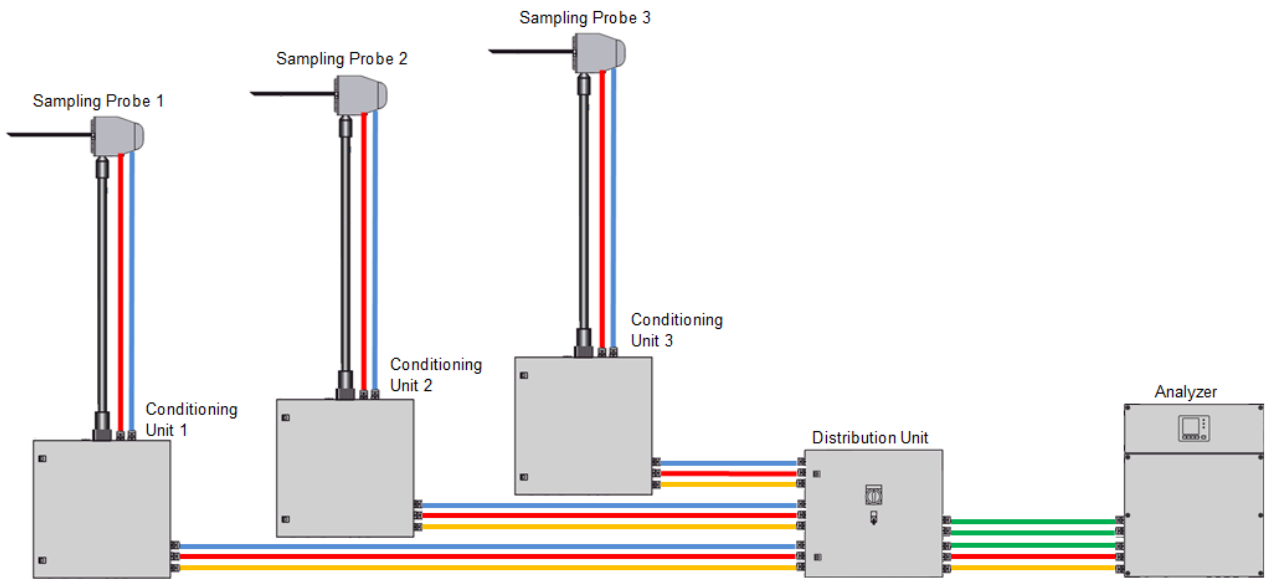

- Red Power (3x1.5; Order no: 6056215)
- Blue Signal (4x0.75; Order no: 6056229)
- Green Signal (7x1.5; Order no: 6056230)
- Yellow PTFE line (4/6; Order no: 5310243)

4 measuring points

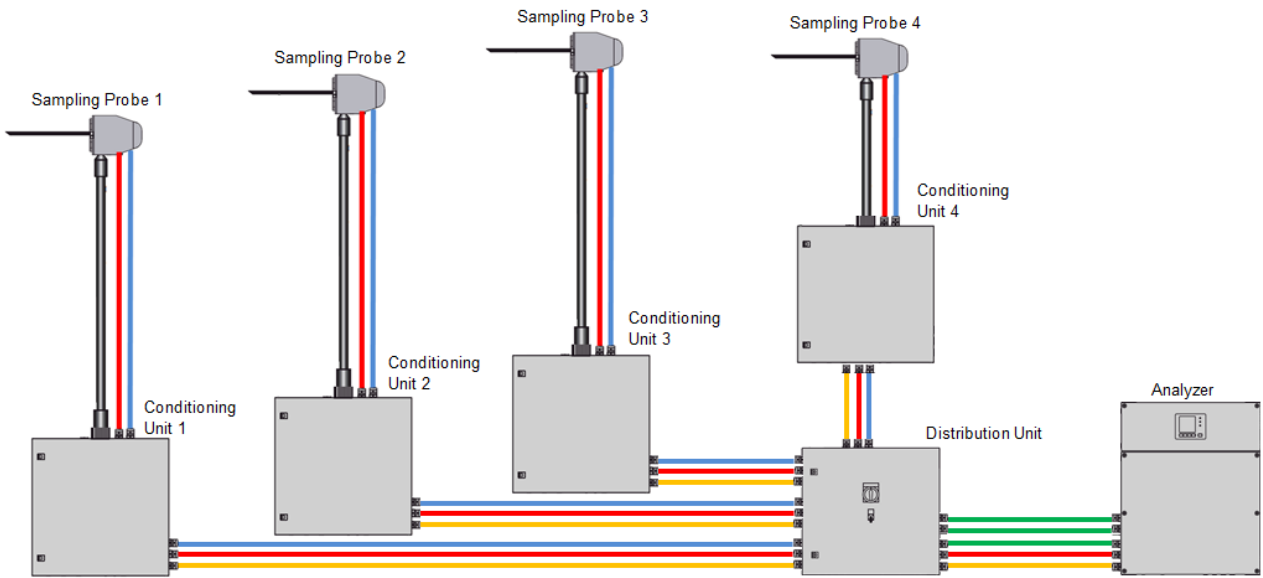

- Red Power (3x1.5; Order no: 6056215)
- Blue Signal (4x0.75; Order no: 6056229)
- Green Signal (7x1.5; Order no: 6056230)
- Yellow PTFE line (4/6; Order no: 5310243)

## 2.6 Checklist for mechanical and electrical installation



**NOTE**

The circuit diagrams shown in this Chapter are also available in larger format in the system documentation..

### 2.6.1 Installing the enclosure

Table 3: Installing the enclosure

Enclosure	Reference
Installation of sampling probe	see "Installing the sampling probe", page 21
Installation of sample conditioning	see "Fitting the sample conditioning", page 24
Installation of distribution unit	see "Installing the distribution unit", page 27
Installation of analyzer	see "Fitting the analyzer", page 34
Optional: Installation of MPR	see enclosed "MPR Operating Instructions"

### 2.6.2 Laying and connecting the gas lines

Table 4: Connecting gas lines

<sup>1</sup>	Gas line	Connection
②	Heated sample gas line: From sampling probe to sample conditioning	Sampling probe: see chapter 2.7 Sample conditioning: see chapter 2.9.2
⑥	Sample gas line: From sample conditioning to distribution unit	Sample conditioning: see chapter 2.9.2 Distribution unit: see chapter 2.10.2
⑩	Sample gas line: From distribution unit to analyzer	Distribution unit: see chapter 2.10.2 Analyzer: see chapter 2.11.2
⑬	Analyzer sample gas outlet	Analyzer: see chapter 2.11.2
⑤	Instrument air feeding to sample conditioning	Sample conditioning: see chapter 2.9.2
⑤	Test gas feeding to sample conditioning (optional)	
③	Instrument air feeding from sample conditioning to sampling probe (optional)	Sample conditioning: see chapter 2.9.2 Sampling probe: see chapter 2.7
⑭	Zero gas feeding to distribution unit	Distribution unit: see chapter 2.10.2
⑮	Sample conditioning condensate outlet	Sample conditioning: see chapter 2.9.2

<sup>1</sup> Numbering see "Installation overview", page 11

2.6.3 Lay and connect the electric lines between sampling probe with sample conditioning and distribution unit

MULTI version distribution unit for two to four measuring points

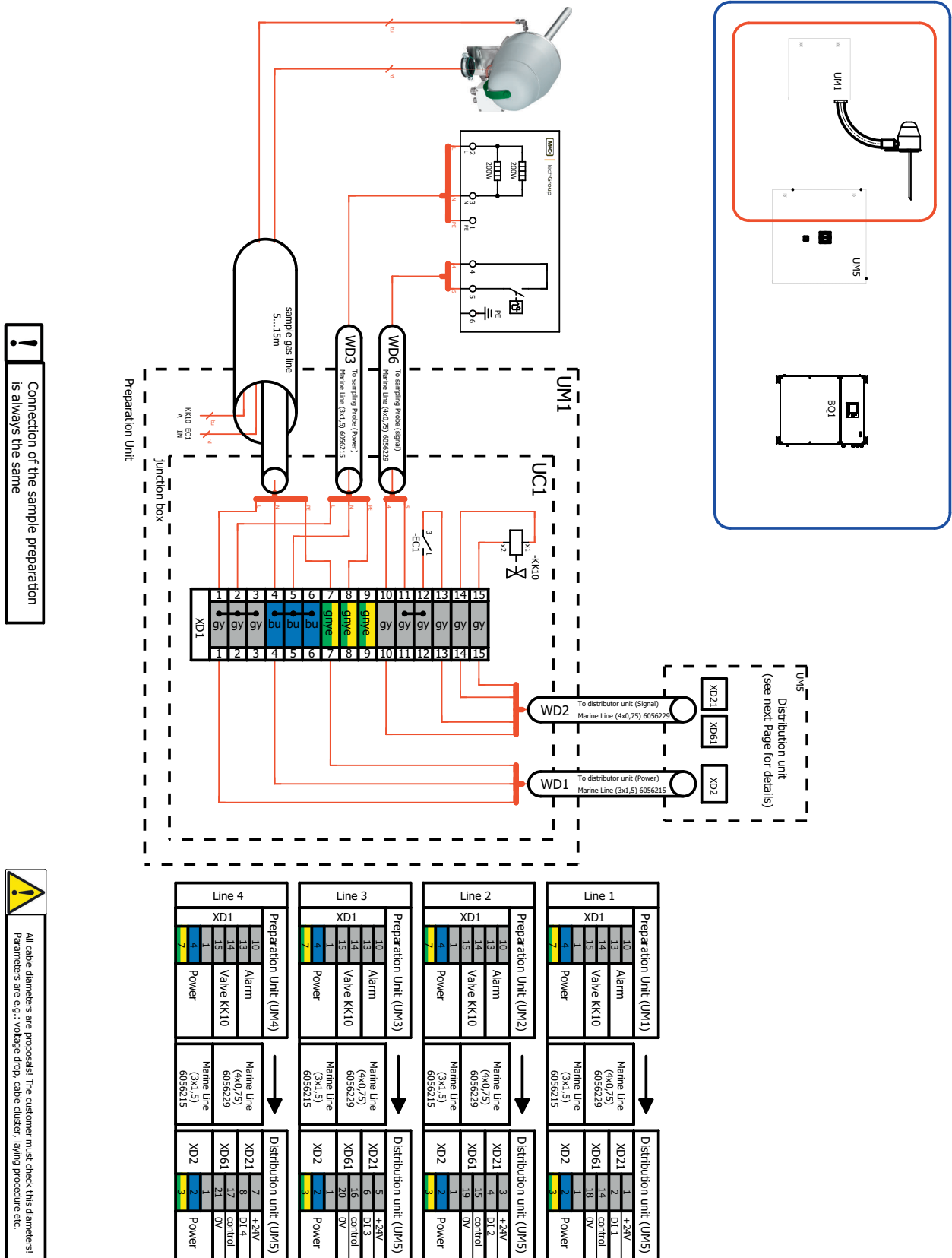
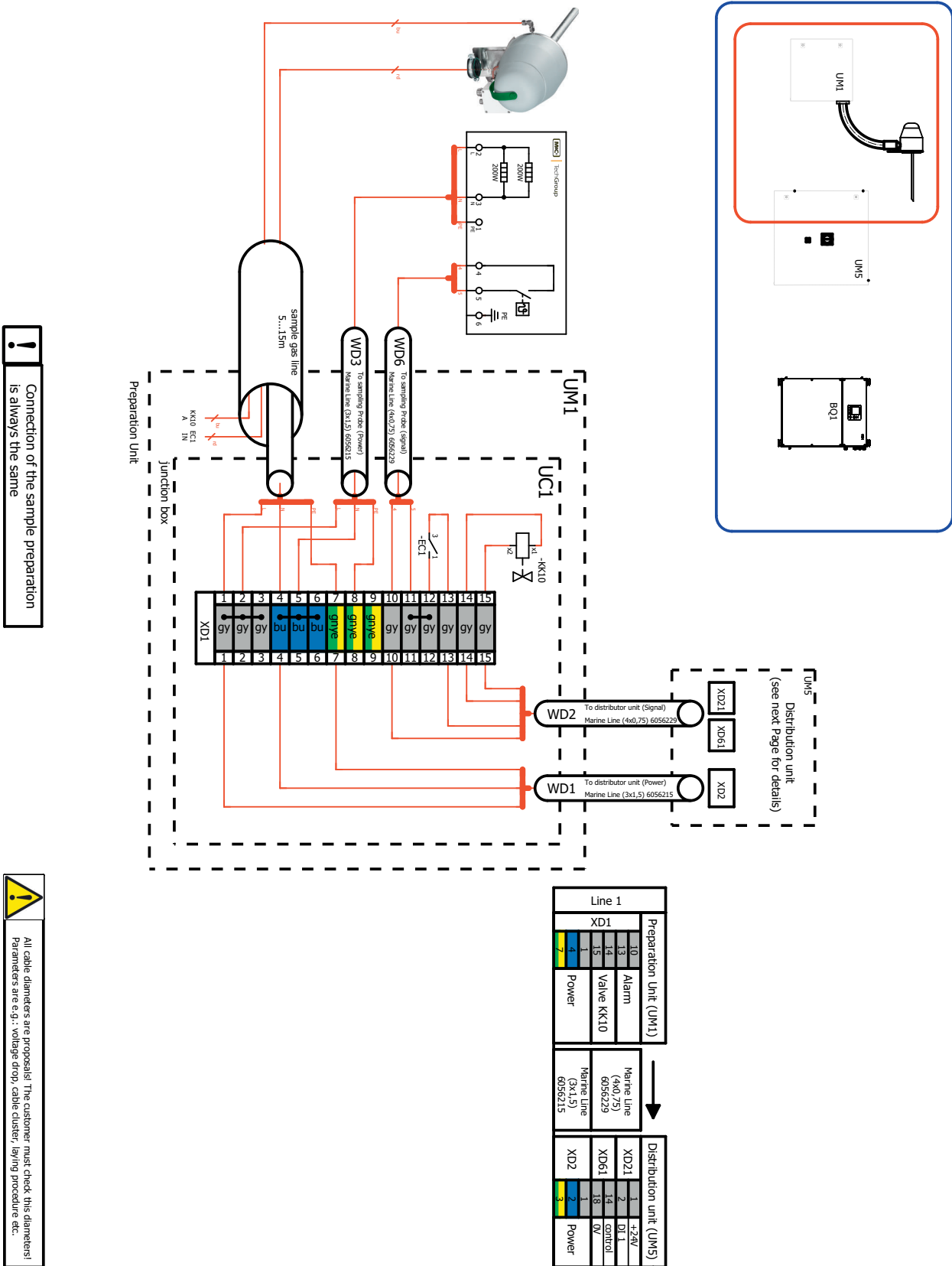

Figure 3: Wiring diagram



SINGLE version distribution unit for one measuring point



Connection of the sample preparation is always the same

All cable diameters are in mm. The customer must check the diameters! Parameters are e.g.: voltage drop, cable cluster, laying procedure etc.

Figure 4: Wiring diagram

Line	Connection
Power supply from distribution unit to sample conditioning	Distribution unit: <a href="#">see "Electrical installation of distribution unit", page 31</a> Sample conditioning: <a href="#">see chapter 2.9.3</a>
Power supply from sample conditioning to sampling probe	Sample conditioning: <a href="#">see chapter 2.9.3</a> Sampling probe: <a href="#">see chapter 2.7</a>
Status signals between analyzer and sample conditioning	Distribution unit: <a href="#">see "Electrical installation of distribution unit", page 31</a> Sample conditioning: <a href="#">see chapter 2.9.3</a>
Status signals from sampling probe to sample conditioning	Sampling probe: <a href="#">see chapter 2.7</a> Sample conditioning: <a href="#">see chapter 2.9.3</a>

2.6.4 Lay and connect the electric line between distribution unit and analyzer

MULTI version distribution unit for two to four measuring points

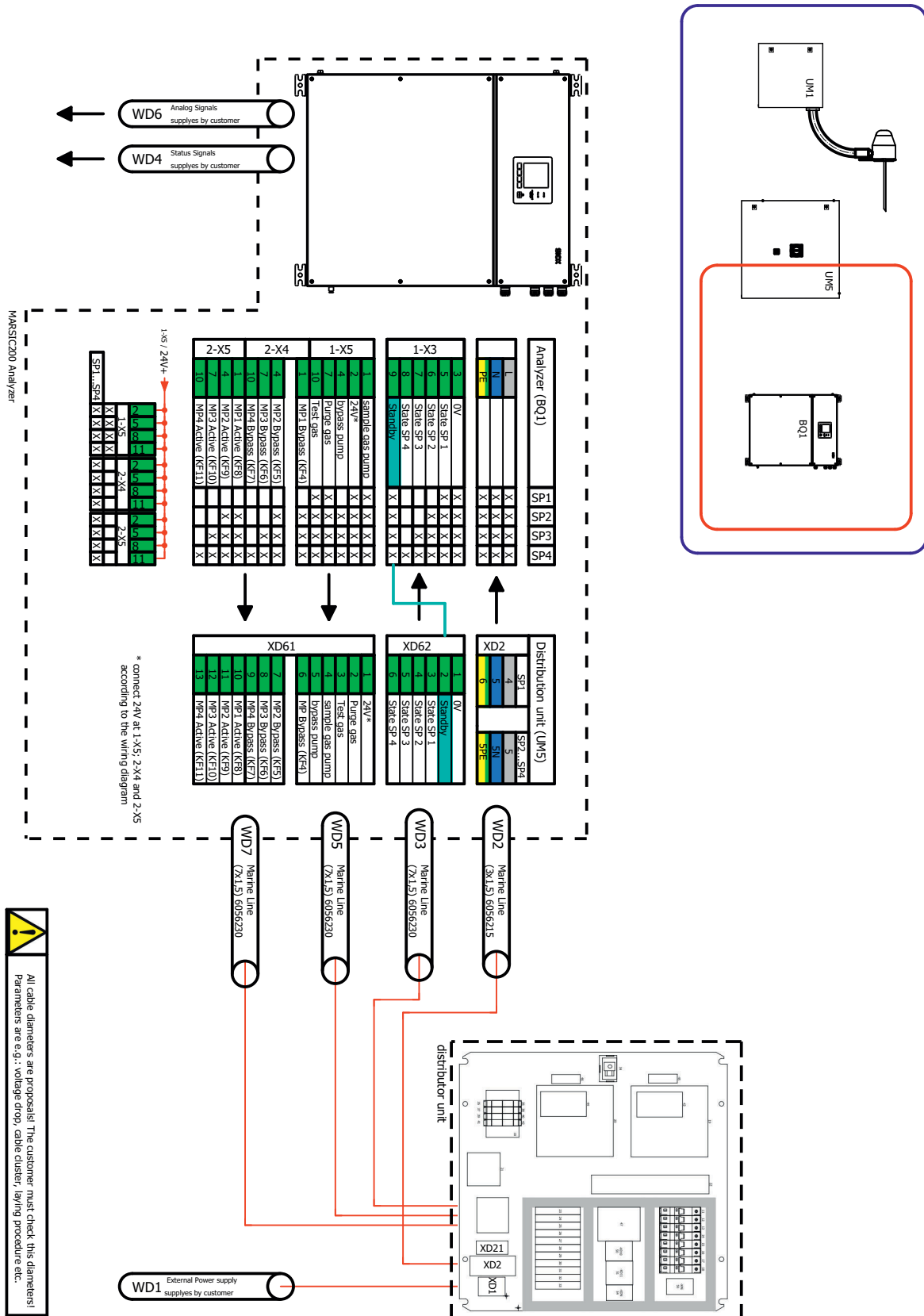

Figure 5: Wiring diagram

SINGLE version distribution unit for one measuring point

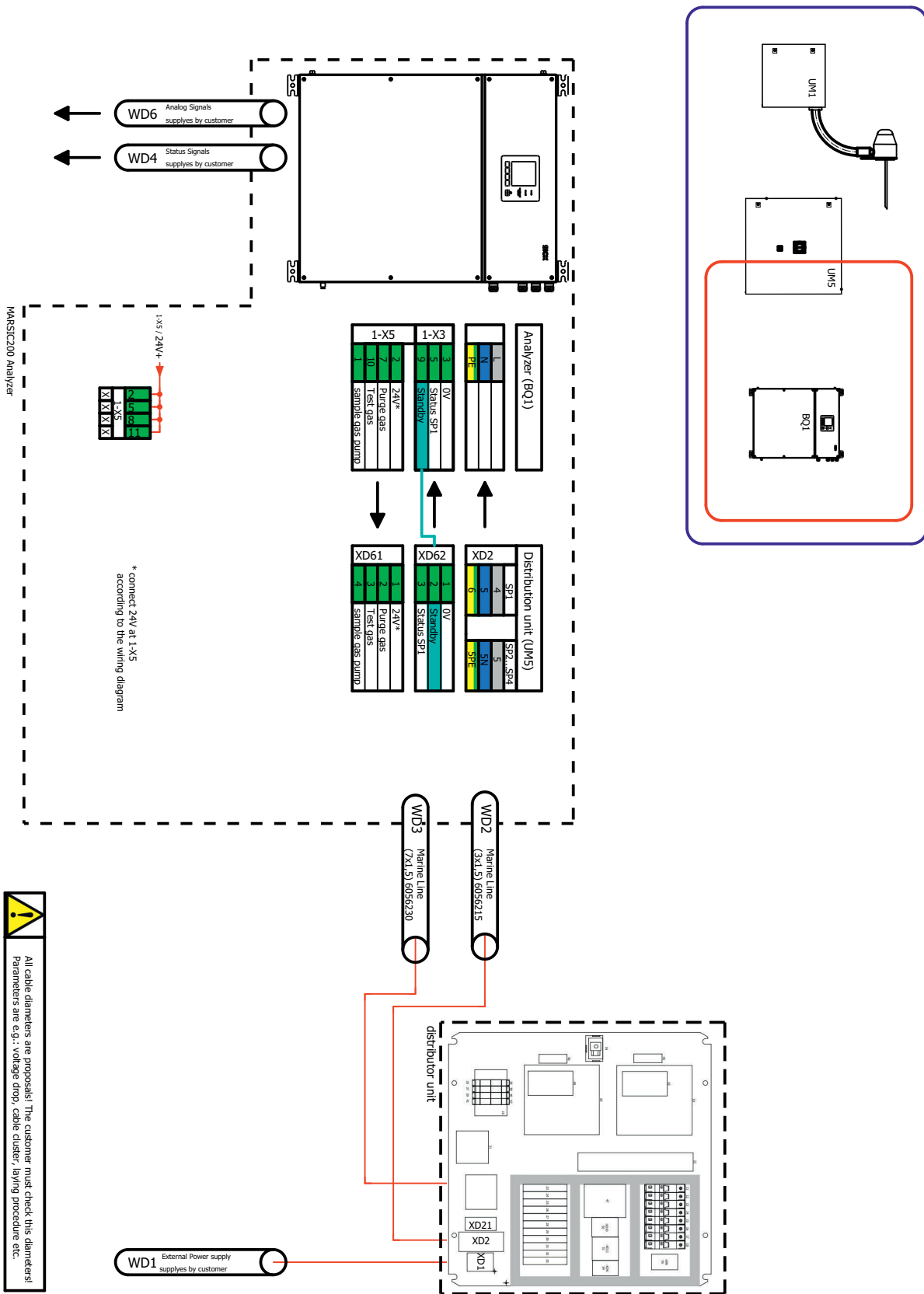

Figure 6: Wiring diagram



**NOTE**

Pay attention to the function indicator of the terminals!  
 Example: 1-X3:9 “Standby” to XD62:2 “Standby”.

Line	Connection
External power supply on distribution unit	Distribution unit: <a href="#">see "Electrical installation of distribution unit", page 31</a>
Power supply from distribution unit to analyzer	Distribution unit: <a href="#">see "Electrical installation of distribution unit", page 31</a> Analyzer: <a href="#">see chapter 2.11.3</a>
Status signals between analyzer and distribution unit	Analyzer: <a href="#">see chapter 2.11.3</a> Distribution unit: <a href="#">see "Electrical installation of distribution unit", page 31</a>
External analog and digital signals, Ethernet to analyzer	Analyzer: <a href="#">see chapter 2.11.3</a>

**2.7 Installing the sampling probe**

The sampling probe is system-specific: For information on the installation of the sampling probe, see the enclosed Operating Instructions of the sampling probe.



**NOTICE**

Risk of soiling the measuring system

- ▶ First install the gas sampling system on the exhaust duct just before the analyzer is switched on.
- ▶ Switch the instrument air feed on immediately after installing the sampling tube.

**Installation**

- ▶ Install the sampling probe in accordance with the specifications in the Operating Instructions of the sampling probe.
  - ▷ Fit the sampling tube with the probe tip tilted down about 10°.

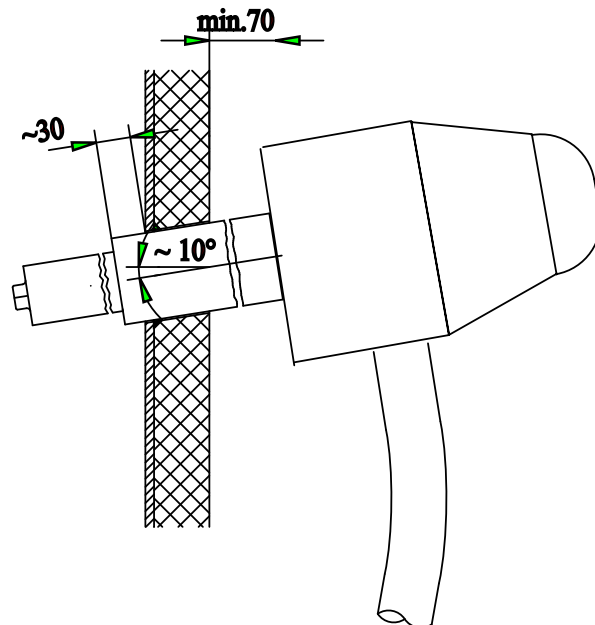

### Gas connections

- ▶ Connect the following gas connections:
  - Heated sample gas line
    - Line marked **red**: Sample gas line
    - Line marked **blue**: Instrument air

### Avoid cold bridges

No cold bridges may occur on the sample gas line connection on the gas sampling probe.

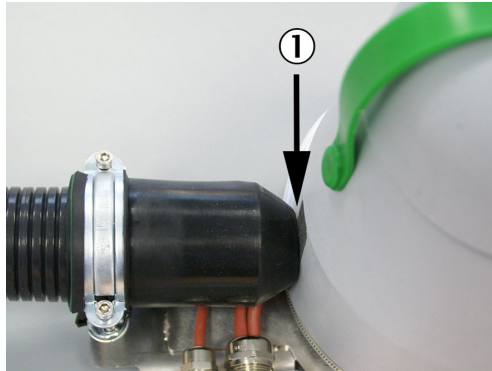

- ① No cold bridges here, close flush or insulate

### Electrical connections

- ▶ Connect the following electric lines:
  - Power supply from sample conditioning
  - “Heating” signal line to sample conditioning

## 2.8 Installing the sample gas line

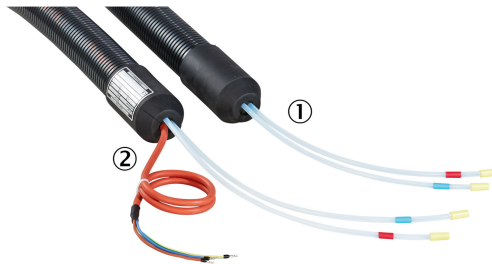

Figure 7: Heated sample gas line

### Installation

- Lay the sample gas line, starting from the sample conditioning towards the sampling probe.



### ATTENTION

Observe the laying instructions for the sample gas line (enclosed with the sample gas line).

**Assembly on the sampling probe**



**ATTENTION**

Do not damage the core of the sample gas line.

- ▶ A hose cutter must be used to cut off the core.

- Shorten the PTFE core of the heated sample gas line to the length of the cap nut of the screw fitting.
- Assembly on the sampling probe: [see "Installing the sampling probe", page 21.](#)

**Assembly on the sample conditioning**

1. Clamp the cable bushing on the corrugated hose approx. 10 cm behind the start of the corrugated hose.  
The groove on the cable bushing must point away from the hose end.

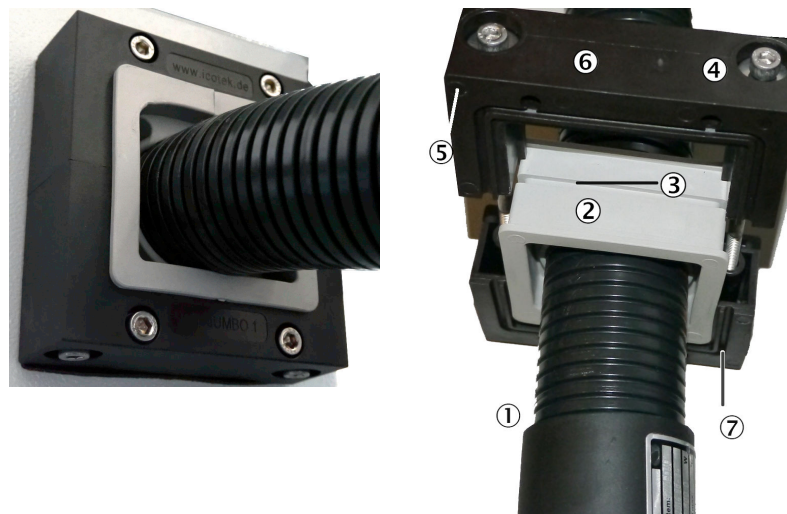

- ① Corrugated hose
- ② Cable bushing
- ③ Groove in cable bushing
- ④ 2 clamping screws (from below or above)
- ⑤ 4 frame screws
- ⑥ Frame
- ⑦ Groove in frame

2. Push the frame with 2 clamping screws over the cable bushing and fasten lightly. The groove of the frame must point towards the hose end (in the direction of the enclosure side).
3. Insert the line in the enclosure.
4. Preassemble the frame on the enclosure.
5. Align the sample gas line so that the electric line points upwards.
  - The line marked **red** (sample gas) must continually lead downwards (danger of clogging by condensate).
6. Connect the lines:
  - ▷ The line marked **red** on the cooler inlet (cooler is system-specific).
  - ▷ The line marked **blue** on the solenoid valve KK10, connection "A".

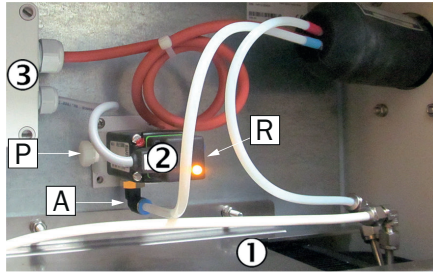

- ① Sample gas cooler (system-specific)
- ② Solenoid valve KK10 for feeding test gas to the sampling probe
- ③ Terminal box
- R Instrument air connection
- P Connection of span gas/test gas
- A Connection to heated sample gas line

7. Screw the lines tight (see "Tube screw fitting", page 9).
8. Check the red mark (sample gas line) and the blue mark (instrument air line) match the connections on the sample gas cooler (see Operating Instructions, Chapter "Removing and fitting the sampling probe").
9. Screw the frame tight (1.5 Nm).
10. Screw the clamping screws tight (1.5 Nm).
11. Electrical connection: See the wiring diagram on the inside of the terminal box cover.
  - o Core cross-section: 1.5 mm<sup>2</sup>.
  - o Connections: BK 1, BK 2, GNYE: See identification rings on the crimp lead end sleeves.

## 2.9 Installing the sample conditioning

### 2.9.1 Fitting the sample conditioning



Figure 8: Sample conditioning (exterior view)

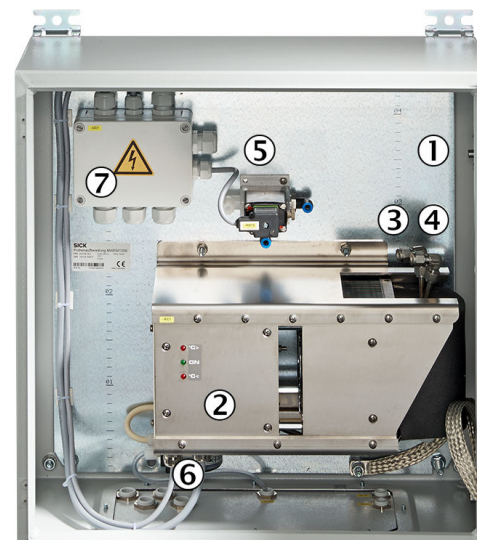

Figure 9: Sample conditioning (interior view, the sample gas cooler is system-specific)

①	Enclosure duct for heated sample gas line
②	Sample gas cooler with hose pump
③	Cooler sample gas inlet (inlet of heated sample gas line)



④	Sample gas outlet from cooler (outlet of unheated sample gas line)
⑤	Solenoid valve KK10 for feeding test gas to the sampling probe
⑥	Hose pump for draining the condensate

Acid condensate escapes from the condensate outlet.

- ▶ Make sure the condensate is safely collected or drained off.
- ▶ The hose end can end max. 10 m above the condensate outlet.



**CAUTION**

Risk of chemical burns by acid medium

- ▶ Take appropriate protective measures for work (for example, by wearing a safety mask, protective gloves and acid resistant clothes).
  - ▶ In case of contact with the eyes, rinse immediately with clear water and consult a doctor.
- 
- ▶ Fasten the enclosure on a suitable panel using the mounting bracket provided.
    - Drilling plan: [see "Dimensional drawings", page 55.](#)
    - Fit the enclosure horizontal.
    - Observe the clearances for the heated sample gas line and the PTFE lines: [see "Dimensional drawings", page 55.](#)
    - Observe the relevant ambient conditions: [see "Technical data", page 55.](#)

**2.9.2 Gas connections on sample conditioning**

**Overview of connection positions**

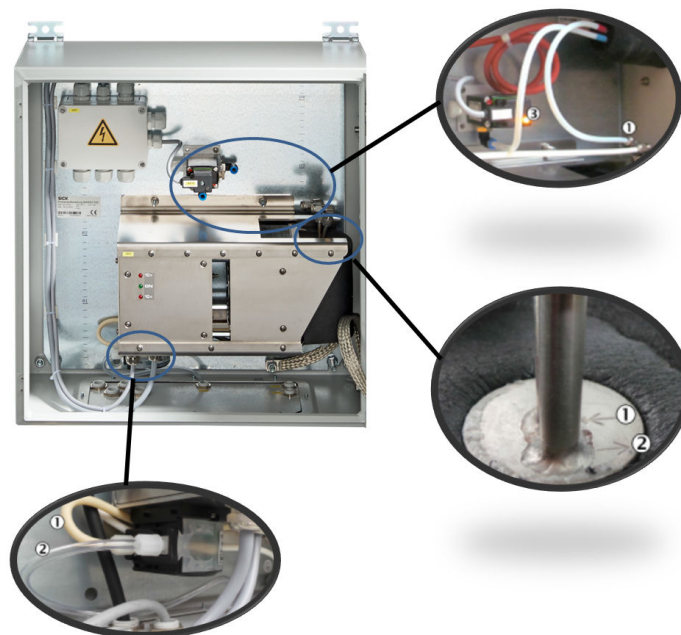

**Connections**

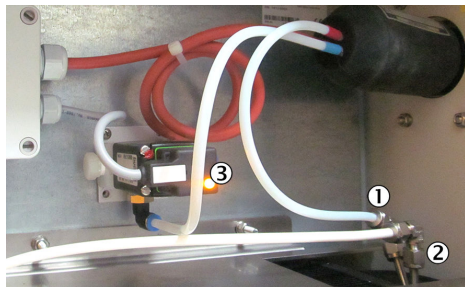

- ① Cooler inlet (observe designation on cooler)
- ② Cooler outlet (observe designation on cooler)
- ③ Solenoid valve KK10, always activated during normal operation (LED on)

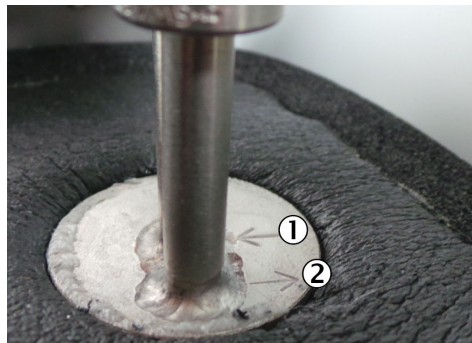

- ① Gas inlet
- ② Gas outlet

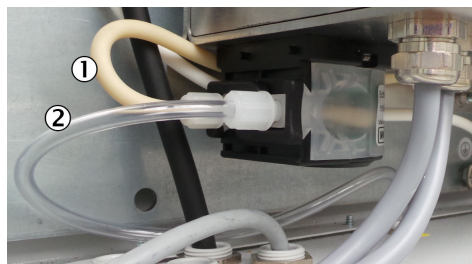

- ① Condensate inlet in hose pump
- ② Condensate outlet from hose pump

- ▶ Lay all PTFE tubes into the enclosure from the bottom.
- ▶ Enclosure duct of heated sample gas line: [see "Installing the sample gas line", page 22.](#)
- ▶ Connect the lines.

Line	Connect to:
Line marked <b>red</b> (sample gas line) from heated sample gas line	Cooler: Gas inlet (see Figure above)
Line marked <b>blue</b> (instrument air/span gas) from heated sample gas line	Solenoid valve KK10: Outlet "A"
PTFE line from external instrument air	Solenoid valve KK10: Inlet "R"
PTFE line from external span gas (only possible for measuring point 1)	Solenoid valve KK10: Inlet "P" If span gas is not connected: Close off the inlet with a dummy plug.
PTFE line sample gas outlet to distribution unit	Cooler: Gas outlet (see Figure above)
Condensate outlet	Cooler: Condensate outlet of hose pump

**Cooler**

The sample gas cooler is system-specific.

- ▶ For further information concerning the sample gas cooler, see the Operating Instructions of the sample gas cooler.

**Condensate outlet**

The condensate outlet is at the bottom of the cooler.

Acid condensate escapes from the condensate outlet.

- ▶ Make sure the condensate is safely collected or drained off.
- ▶ The hose end can end max. 10 m above the condensate outlet.

### 2.9.3 Electrical installation of sample conditioning

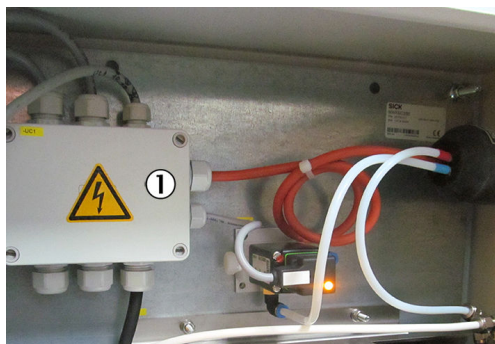

① Terminal box

- ▶ Lay the electric lines through the enclosure openings.
- ▶ Connect the electric lines.
  - For the circuit diagram, see the attached system documentation and inside the cover of the terminal box.

Electric line	Connect to:
Power supply from distribution unit	See enclosed system documentation
Power supply to sampling probe	
Cooler and probe status on distribution unit	
Control signals to sample conditioning from distribution unit	
"Heating" status from sampling probe	
Enclosure grounding optional	

### 2.10 Installing the distribution unit

View

**MULTI version distribution unit for two to four measuring points (example)**



Figure 10: Distribution unit (exterior view)

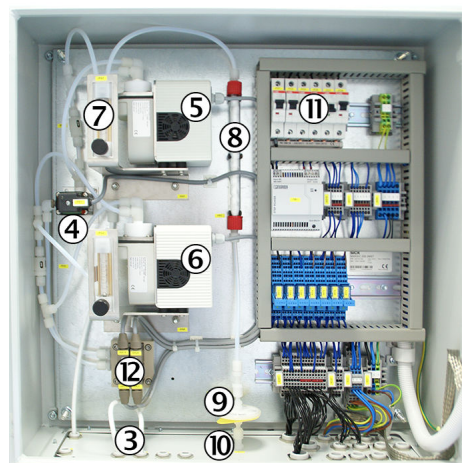

Figure 11: Distribution unit (interior view system-specific)

①	<p>Main switch ON: Voltage is on OFF: Voltage is off</p>	<p>Main switch set to "OFF":</p> <ul style="list-style-type: none"> <li>• Sample conditioning voltage: "OFF"</li> <li>• Sampling probe voltage: "OFF" <ul style="list-style-type: none"> <li>◦ The purge air valve is "open when no current is applied": The sampling tube is flushed with instrument air</li> </ul> </li> <li>• Sample gas line heating: "OFF"</li> <li>• Analyzer voltage: "OFF"</li> </ul> <p>Main switch set to "ON":</p> <ul style="list-style-type: none"> <li>• All voltages come on.</li> </ul>
②	<p>"Stand-by" switch OFF: Regular operation ON: Stand-by</p>	<p>"Stand-by" switched to ON:</p> <ul style="list-style-type: none"> <li>• The maintenance signal on the analyzer becomes "active" and the <b>yellow</b> LED lights</li> <li>• The measured values continue to "live"</li> <li>• A zero point validation is performed</li> <li>• The sample gas pump and the (optional) bypass pump go off</li> <li>• The heaters remain switched on</li> <li>• The sampling tube is flushed with instrument air</li> </ul> <p>"Stand-by" switched to OFF:</p> <ul style="list-style-type: none"> <li>• Sample gas pump and the (option) bypass pump are switched on</li> <li>• The system goes into measuring operation: Only the <b>green</b> LED lights on the analyzer</li> </ul>
③	<p>Sample gas inlet from sample conditioning(s)</p>	
④	<p>Solenoid valve KK1, inlet "R" Connection: D/N 4/6</p>	<p>Sample gas inlet For 1 measuring point: From sample conditioning For 2 ... 4 measuring points: From measuring point switchover in distribution unit</p>
	<p>Solenoid valve KK1, inlet "P" Connection: D/N 4/6</p>	<p>Test gas inlet During test gas adjustment with gas feed on the distribution unit, the test gas is passed directly to the analyzer.</p>
	<p>Solenoid valve KK1, outlet "A" Connection: D/N 4/6</p>	<p>Gas outlet to analyzer</p>
⑤	<p>Sample gas pump</p>	<p>For extraction of the respective active measuring point</p>
⑥	<p>Bypass pump</p>	<p>For advance extraction of the sample gas for 2 ... 4 measuring points</p>
⑦	<p>Flow indicator with adjustment wheel</p>	<p>Setpoint flow rate: Approx. 60 l/h. The flow is displayed as measured value on the analyzer.</p>
⑧	<p>Sample gas fine filter</p>	<p>Serves to filter the sample gas for all measuring points before feeding to the analyzer. The analyzer signals the flow is too low when the filter clogs up.</p>
⑨	<p>Water trap</p>	<p>The water trap protects the analyzer against damp sample gas. The analyzer signals the flow is too low when the filter clogs up.</p>
⑩	<p>Sample gas outlet to analyzer</p>	

⑪	Fuse 1	24 V power supply unit
	Fuse 2...5	1 fuse per measuring point (probe, line, sample conditioning)
	Fuse 6	Sample gas pump
	Fuse 7	Bypass pump (as from 2 measuring points)
	Fuse 8	Analyzer
⑫	Measuring point switchover	

**2.10.1 Fitting the distribution unit**

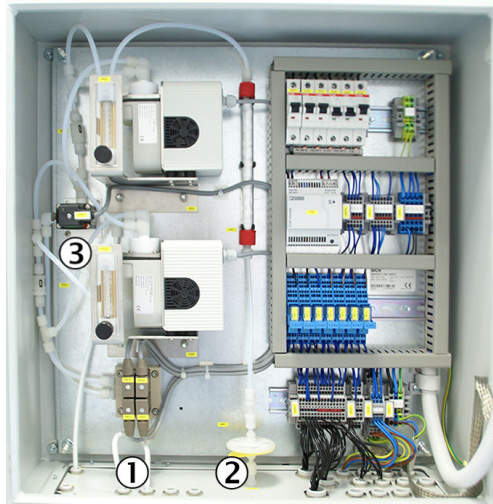

Figure 12: MULTI version distribution unit for two to four measuring points (example)

- ① Connection of PTFE line from sample conditioning
  - ② Connection of PTFE line to analyzer
  - ③ Valve KK1
- Fasten the enclosure on a suitable panel using the mounting bracket provided.
- Drilling plan: [see "Dimensional drawings", page 55.](#)
  - Fit the enclosure horizontal.
  - Observe the clearance for the PTFE line: [see "Dimensional drawings", page 55.](#)
  - Observe the relevant ambient conditions: [see "Technical data", page 55.](#)



2.10.2 Gas connections on distribution unit

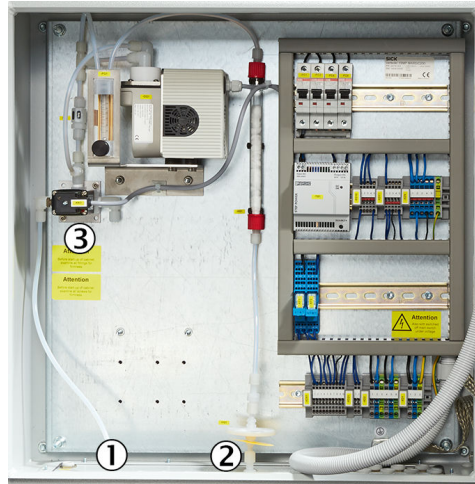

Figure 13: SINGLE version distribution unit for one measuring point (example)

- ① Gas inlet from sample conditioning(s)
- ② Gas outlet to analyzer
- ③ Valve KK1

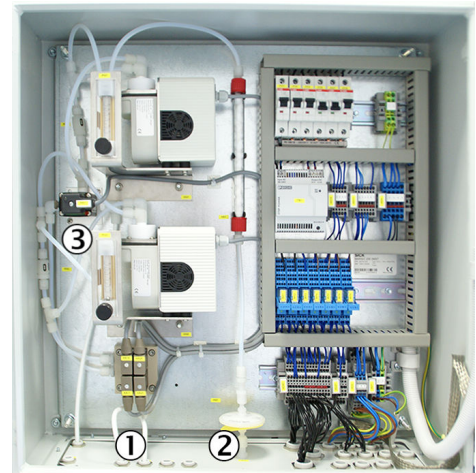

Figure 14: MULTI version distribution unit for two to four measuring points (example)

- ① Connection of PTFE line from sample conditioning
- ② Connection of PTFE line to analyzer
- ③ Valve KK1

- ▶ Lay all PTFE tubes into the enclosure from the bottom.
- ▶ Connect the lines.

Line	Connection of SINGLE version	Connection of MULTI version
PTFE line from sample conditioning (sample gas inlet)	Valve KK1, inlet "R"	Measuring point switchover "P1-P4"
PTFE line to analyzer (sample gas outlet)	Sample gas outlet on the enclosure outside	
Test gas inlet (zero gas: nitrogen or instrument air) <sup>1</sup>	Valve KK1, inlet "P"	

<sup>1</sup> This gas is used as zero gas during automatic zero point adjustment. When the reference point is adjusted via the distribution unit (not via the sampling probe), the span gas must be connected to this inlet during the adjustment.

2.10.3 Electrical installation of distribution unit

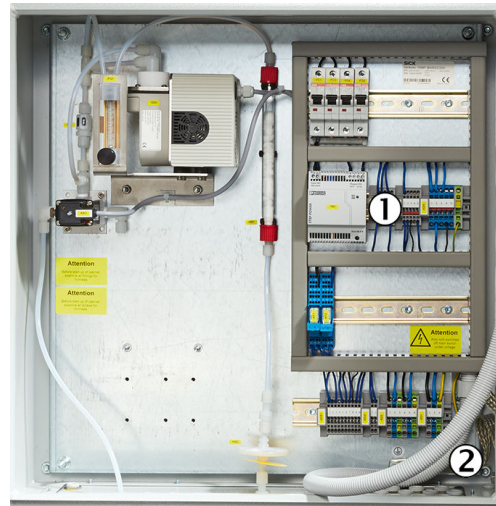

Figure 15: SINGLE version distribution unit for one measuring point (example)

- ① Terminal strips
- ② Grounding

- ▶ Lay the electric lines through the enclosure openings.
- ▶ Connect the electric lines.
  - For the circuit diagram, see the attached system documentation and inside the cover of the terminal box.

Electric line	Signal	Connect to:
External power supply		See the wiring diagram in the system documentation
Power supply to sample conditioning		See the wiring diagram in the system documentation
Power supply to analyzer		See the wiring diagram in the system documentation
Status signals from sample conditioning	DI	Sampling probe and cooler See the wiring diagram in the system documentation
Control signals to sample conditioning	DO	See the wiring diagram in the system documentation
Signal lines to/from analyzer	DI	See the wiring diagram in the system documentation
	DO	See the wiring diagram in the system documentation
	AI	See the wiring diagram in the system documentation
	AO	See the wiring diagram in the system documentation
Signal lines to/from external	DI	See the wiring diagram in the system documentation Optional for stand-by operation
	DO	See the wiring diagram in the system documentation Maintenance and status
	AI	See the wiring diagram in the system documentation optional
	AO	See the wiring diagram in the system documentation Meas. values
Enclosure grounding		Inside, bottom right.

- ▶ Install an external power disconnection unit which disconnects all connectors and fuses near the analyzer. The power disconnection unit must have a unique marking and be easily accessible.  
Observe the max. power input of the complete system: [see "Energy supply", page 64.](#)

- ▶ The local power network for power supply to the system must be installed and safeguarded in accordance with the relevant regulations.
- ▶ A protective conductor must always be connected to PE.

### 2.10.4 Measuring point switchover

#### Measuring point switchover

For systems with 2 to 4 measuring points, a measuring point switchover with advance extraction of the sample gas is installed.

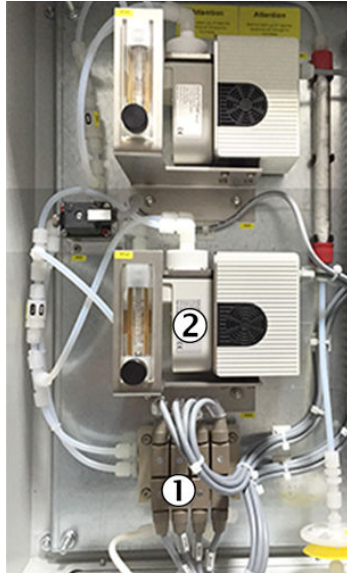

Figure 16: Measuring point switchover for 4 measuring points (example)

- ① Measuring point switchover
- ② Advance extraction

- ▶ Installation: see ["Gas flow diagram"](#), page 59.
- ▶ Programming the measuring point switchover: see ["Measuring points - automatic"](#), page 52.



## 2.11 Installing the analyzer

### Exterior view



Figure 17: Analyzer (exterior view)

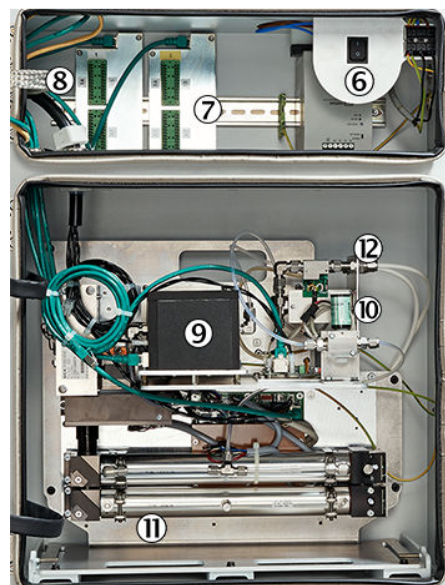

Figure 18: Analyzer (interior view)

①	Analyzer top part with electronics	
②	Control unit	
③	Analyzer bottom part with measurement technology	
④	Sample gas inlet	Screw fitting: DN4/6 stainless steel
⑤	Sample gas outlet	Screw fitting: DN4/6 stainless steel
⑥	On/Off switch	The On/Off switch switches the analyzer on/off. <ul style="list-style-type: none"> <li>• The digital outputs switch to “Zero”</li> <li>• The analog outputs switch to “Zero”</li> </ul>
⑦	Data interfaces	Analog and digital inputs and outputs
⑧	Fuse	Check the fuse
⑨	Measuring module CO <sub>2</sub> (FINOR)	
⑩	Measuring module O <sub>2</sub> (OXOR E)	optional
⑪	Measuring module SO <sub>2</sub> /NO <sub>x</sub> (DEFOR)	
⑫	Measuring module flow/humidity/pressure (gas module)	

### 2.11.1 Fitting the analyzer

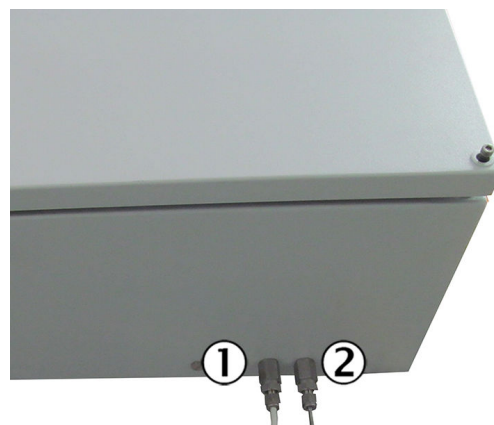

Figure 19: Clearance for PTFE lines

- ① PTFE line (sample gas inlet)
- ② PTFE line (sample gas outlet)

- ▶ Fasten the analyzer on a suitable panel using the mounting bracket provided.
  - Drilling plan: see ["Dimensional drawings"](#), page 55.
  - Fit the enclosure horizontal.
  - Observe the clearance for the PTFE line: see ["Dimensional drawings"](#), page 55.
  - Observe the relevant ambient conditions: see ["Technical data"](#), page 55.

### 2.11.2 Gas connections on analyzer



- ① Sample gas inlet (seen from the front, bottom left)
- ② Sample gas outlet (seen from the front, bottom right)

- ▶ Lay all PTFE tubes into the enclosure from the bottom.
- ▶ Connect the lines.

Line	Connect to:
PTFE line from distribution unit (sample gas inlet)	Lower part of analyzer, to enclosure duct "Inlet"
PTFE line sample gas outlet	Lower part of analyzer, to enclosure duct "Outlet"

**Sample gas outlet**

- ▶ Discharge the sample gas outlet in a suitable environment.
- ▶ The sample gas output must be open against the ambient pressure.



**WARNING**

The exhaust gases are toxic

- ▶ Dispose of the exhaust gases in a suitable manner.

**2.11.3 Electrical installation of analyzer**

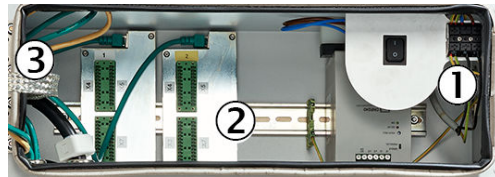

- ① Power voltage connection at terminal strip
- ② Signal connections (I/O)
- ③ Distributor board with Ethernet for MPR (option), Modbus, service interface (LAN)

Electric line	Connect to:
Power supply from distribution unit	Terminal strip near On/Off switch
Signal lines to/from distribution unit	See attached circuit diagram
Analyzer grounding	On the right of the enclosure outside
MPR for remote maintenance via Ethernet (option)	In analyzer upper part on distribution board RJ45 connection 0X5 "LAN"
PC with SOPAS ET (Ethernet) (option)	
Modbus	



**NOTE**

The green coiled network line in the analyzer bottom part serves as spare line and does not have to be connected.

## 3 Initial start-up

### 3.1 Initial start-up



#### NOTE

Prerequisite: The system has been fully installed and connected

1. Check installation is correct.
2. Instrument air must be available on the sample conditioning and zero gas on the distribution unit.
3. Remove the red protective foil from the control unit on the analyzer.
4. Switch on all fuses in the distribution unit.
- ✓ The LEDs on the control unit are on, the measured values blink.
5. Set the Stand-by switch on the distribution unit to **OFF** (normal operation).
6. Set the number of available measuring points.
  - Four measuring points are activated upon delivery
  - Set the available number of measuring points:
    - ▶ Login as “Service” on the operator panel in menu Login.
    - ▶ Call up menu Parameter/Special fct./Meas.point autom./Meas.point (MPi).

See logbook	
Meas.point (MPi)	.5.10.1.1
1 1	On
2 2	On
3 3	On
4 4	On
./Parameter/Special fct.	
Back	↑ ↓ Enter

- ▶ Activate each measuring point desired (set to “On”).
7. Set the date and time in menu Parameter/Date-Time.
  8. Wait until the system has warmed up (approx. 2 hours).
  9. The system performs an automatic zero point adjustment.
  10. The **green** LED goes on, the measured values do not blink and **MEASURE** is shown on the screen
  11. Check the flow rate on the flowmeter (in the distribution unit): Approx. 60 l/h. Set on the flowmeter when necessary.
  12. Check that only the **green** LED lights on the control unit.
    - When the yellow or red LED is on: Press the “DIAG” button and/or check in the logbook.
  13. Check the time. Set the time, if required: Menu: Parameter/Date-Time.
  14. Configure the test gas concentration in the respective menu on the control unit: See “Operating Instructions MARSIC200”.
  15. Perform manual test gas adjustment: See “Operating Instructions MARSIC200”.
  16. Check measured values for plausibility.
  17. Perform the leak tightness check: See “Operating Instructions MARSIC200”.
  - ✓ The system is in operation.

**NOTICE**

If you change parameters in the control unit (BCU) as required by the operating company:

- ▶ Save the BCU settings in a suitable manner (for example on a USB stick) and keep this backup.

To do this, connect the analyzer to a PC and use the SICK SOPAS-ET software (see "[Backup of settings](#)", page 53).

---

## 4 Configuration software

### 4.1 Software SOPAS ET

The MARSIC200 can be easily configured on a PC with SOPAS ET.

SOPAS ET runs on an external PC connected to the MARSIC200 via the Ethernet interface.

You can download SOPAS ET free of charge from the SICK website.

- Install SOPAS ET on a laptop.
- Connect the laptop to the MARSIC200 analyzer (Ethernet cable): see ["Electrical installation of analyzer"](#), page 35.
- Open SOPAS ET.
- In SOPAS ET: Click "Device search".
- The MARSIC200 modules are displayed:
  - Gas module (measuring module for flow, moisture and pressure of the sample gas in the analyzer)
  - DEFOR (measuring module for NO, NO<sub>2</sub> and SO<sub>2</sub> of the sample gas in the analyzer)
  - FINOR (measuring module for CO<sub>2</sub> of the sample gas in the analyzer)
  - OXOR (measuring module for O<sub>2</sub> of the sample gas in the analyzer (optional))
- Mark all modules and drag and drop them into the left window (Project).
- Save the project.
- Login to configure the modules (click "Login").  
Enter the password, see ["Passwords"](#), page 38.
- To configure: Double-click on the module window.



#### NOTE

See "Technical Information BCU" for menus based on SOPAS ET.

### 4.2 Passwords

There are three user levels each with an own password.

The passwords are the same for operation using the analyzer control unit and for using SOPAS ET.

User level	Password (case-sensitive)
MARSIC	EMI
Authorized operator	HIDE
Service	hidden

# 5 Adjustment functions

## 5.1 Configuring test gases (Test Gas Table)

### Function

The Test Gas Table serves as basis for adjustments. 12 different test gas settings can be programmed. Each test gas setting can be used for up to 8 components. The test gas settings can also be used for validation measurements.



### NOTE

- The same real test gas can be used in several test gas settings. This means a certain test gas can be used for different adjustment procedures.
- Recommendation: Only program one adjustment or validation function for each test gas.
- Suitable test gas settings are normally preprogrammed at the factory.

### Procedure

1. Call up BCU/Parameter/Test gas table.

Test gas table												
<input type="checkbox"/> Live view												
<input type="button" value="Mark"/> <input type="button" value="Edit"/>												
Index	enable	Name	Pump off	Signal	Comp. 1	Comp. 2	Comp. 3	Comp. 4	Comp. 5	Comp. 6	Comp. 7	Comp. 8
1	<input checked="" type="checkbox"/>	Zero gas	<input checked="" type="checkbox"/>	BVO05	s1mv 1	s1mv2	s1mv3					
2	<input checked="" type="checkbox"/>	NO	<input checked="" type="checkbox"/>	BVO06	s1mv 1							
3	<input checked="" type="checkbox"/>	SO2	<input checked="" type="checkbox"/>	BVO07	s1mv 2							
4	<input checked="" type="checkbox"/>	H2S	<input checked="" type="checkbox"/>	BVO08	s1mv3							
5	<input type="checkbox"/>		<input type="checkbox"/>	BVO09								
6	<input type="checkbox"/>		<input type="checkbox"/>	BVO10								
7	<input type="checkbox"/>		<input type="checkbox"/>	BVO11								
8	<input type="checkbox"/>		<input type="checkbox"/>	BVO12								
9	<input type="checkbox"/>		<input type="checkbox"/>	BVO13								
10	<input type="checkbox"/>		<input type="checkbox"/>	BVO14								
11	<input type="checkbox"/>		<input type="checkbox"/>	BVO15								
12	<input type="checkbox"/>		<input type="checkbox"/>	BVO16								

Figure 20: Menu "Test gas table" – Table (example)

2. Deactivate Live view.
3. Select the desired Table rows.
4. Select **Edit**.

**Test gas table**

---

Index  ①

enable  ② Name  ③ Signal  ④ Pump off  ⑤

---

Component 1 enable  ⑥

Component  ⑦ Val. zero p.  ⑫ Val. ref. p.  ⑬

Component name  ⑧ Adj. zero p.  ⑭ Adj. ref. p.  ⑮

Concentration  ⑨  Val. ref. p. w. cuv.  ⑯

Purge time [s]  ⑩ Adj. ref. p. w. cuv.  ⑰ Linearize  ⑱

Cuvette  ⑪

---

Component 2 enable

Component  Val. zero p.  Val. ref. p.

Component name  Adj. zero p.  Adj. ref. p.

Concentration  Val. ref. p. w. cuv.

Purge time [s]  Adj. ref. p. w. cuv.  Linearize

---

Component 3 enable

Figure 21: Menu “Test gas Table” – Edit (example)

- ① Test gas number (cannot be changed).
- ②  = this test gas can be used for adjustments/validations.
- ③ Test gas name (free text field, max. 20 characters).
- ④ Boolean variable to control this test gas (cannot be changed).
- ⑤  = the sample gas pump is switched off automatically when this test gas is used.
- ⑥  = this test gas can be used for the specified component.
- ⑦ Tag of the component for which this test gas is to be used.<sup>1</sup>
- ⑧ Component name in the Sensor module (cannot be changed).
- ⑨ Setpoint value of the test gas in the physical unit of the measuring component.  
► Use the decimal point (.) for numerical values.
- ⑩ Wait time after switching to the test gas. The measurement for the adjustment/validation first starts after the flush time/wait time.<sup>2</sup>
- ⑪ Cuvette: Concentration of the adjustment cuvette
- ⑫  = the test gas is used for zero point validations.  
Simultaneous use for reference point validations is not possible.
- ⑬  = the test gas is used for reference point validations..  
Simultaneous use for zero point validations or reference point validations with adjustment cuvette is not possible.
- ⑭  = the test gas is used for zero point adjustments.  
Simultaneous use for reference point adjustments is not possible.
- ⑮  = the test gas is used for reference point adjustments.  
Simultaneous use for zero point validations or reference point validations with adjustment cuvette is not possible.



- ⑯  = the test gas is used for reference point validations with adjustment cuvette.  
Simultaneous use for reference point validations is not possible.
- ⑰  = the test gas is used for reference point adjustments with adjustment cuvette.  
Simultaneous use for reference point adjustments is not possible.
- ⑱  = the test gas is used for linearity adjustments.  
Simultaneous use for other adjustments is not possible.

- <sup>1</sup> Tag format: SiMVj (i = Sensor module number, j = measured value number in the Sensor module)
- <sup>2</sup> The longest flush time is effective when the test gas is used simultaneously for several components.

**NOTE**

The settings are first effective after **Save** has been selected.

## 5.2 Performing a manual adjustment

**Function**

“Manual adjustment” means a single adjustment or validation procedure is selected and manually started.

**NOTE**

The standard setting with checkbox “Automatic” selected (see figure 23, page 43) means the test gas is fed automatically via solenoid valves controlled by the MARSIC200 digital outputs. The controlling output is defined in the respective test gas setting (“Action on start” see “Configuring test gases (Test Gas Table)”, page 39). The test gas can also be fed manually.

**Procedure**

- ▶ Inform connected locations on the impending interruption in measuring operation.

1. Call up **BCU/Maintenance/Manual adjust**.
2. Select the measuring component for which the procedure is to be applicable ([ << ] [ >> ]).
3. Select the desired function ([ << ] [ >> ]).
- ✓ The **Start** button is displayed when a suitable test gas setting exists for the measuring component and function combination.
4. Select **Start**.

**With manual test gas feed**

- ✓ Actual state = **Test gas**
- 5 Feed the suitable test gas into the sample gas inlet of the MARSIC200.
- 6 Wait until **Sample gas** is displayed as actual state.
- 7 Now feed sample gas into the sample inlet again.<sup>1</sup>
- 8 Wait until **Stop** is displayed as actual state.
- ✓ The manual adjustment has completed.

**With automatic test gas feed**

- ✓ The automatic procedure starts.  
Actual state = part of the procedure currently running (see table 5, page 42)
- 5 Wait until **Stop** is displayed as actual state.
- ✓ The manual adjustment has completed.

- <sup>1</sup> Alternative (when a further manual adjustment is to follow): The test gas for the next manual adjust

Table 5: Procedure phases during manual adjustment

Actual state	Internal function
Stop	Function idle
Test gas	Wait for flush time to elapse (after switching to test gas)
Measuring	Determine measured values with the test gas
Calculate	Calculate mean value from measuring time, calculate deviation from setpoint, adapt adjustment
Sample gas	Wait for flush time to elapse (after switching to sample gas)

Table 6: Information in menu *Manual adjustment* during the procedure

Identifier	Significance
Actual state	Part of the procedure running (see table 5, page 42)
Meas. value	Current measured value of component
Actual countdown timer (SCCDGi)	Name of countdown timer running
Remaining time	Remaining time of countdown timer running

### Manual adjust

---

Measured value(s)  ①

Sensor component  ②

Sensor no.  ③

Component no.  ④

Automatic  ⑤   ⑥

---

Function  ⑦   ⑧

Test gas name  ⑨      Concentration  ⑩

Test gas time  s ⑪      (SCCDG1)

Meas. time  s ⑫      (SCCDG2)

Calc. time  s ⑬      (SCCDG3)

Sample gas time  s ⑭      (SCCDG4)

⑮

---

Actual state       Measured value

Actual countdown (SCCDG1)       Remaining time

Error

Figure 22: Menu Manual adjust (example)

- ① Name of the measured values to be calculated from this sensor component
- ② Measuring component for which this manual adjust is applicable
- ③ Number of the Sensor module to measure the measuring component
- ④ Number of sensor component in the Sensor module
- ⑤  = standard setting: Adjustment runs with preset time sequences.  
 = adjustment steps are started singly by the user (manual test gas feed).
- ⑥ Select measured value(s)
- ⑦ Adjustment or validation to be performed
- ⑧ Select function
- ⑨ Name of test gas to be used<sup>1</sup>
- ⑩ Setpoint value of the test gas / concentration of the adjustment cuvette
- ⑪ Wait time after switching to the test gas; then measurement starts
- ⑫ Defines how long the measured values of the test gas are measured<sup>2</sup>
- ⑬ Internal interval for computation of the values measured

- ④ Wait time after switching to sample gas, then the manual adjustment is regarded as completed
- ⑤ Start the selected manual adjustment

- <sup>1</sup> Empty field: No suitable test gas setting programmed for the selected function
- <sup>2</sup> Actual value for the adjustment = mean value of measured values within the measuring time

### Result

**Einzelabgleich**

Messwert(e)

Sensorkomponente

Sensor-Nr.

Komponenten-Nr.

Automatik  << >>

---

Funktion  << >>

Testgas  Konzentration

Testgas-Spülzeit  s (SCCDG1)

Messdauer  s (SCCDG2)

Berechnungszeit  s (SCCDG3)

Messgas-Spülzeit  s (SCCDG4)

①

---

Aktueller Status  Messwert

Aktueller Countdown-Timer (SCCDG)  Restzeit

② Fehler  Ergebnis  ③

Figure 23: Menu Manual adjust with result (example)

- ① Cancel the running manual adjust
- ② Error shown when no result available. Erroneous sequence or drift overrun.
- ③ The actual measured value measured

### 5.3 Automatic adjustments/validations

### 5.3.1 Function of automatic adjustments/validations

8 adjustment or validation procedures that can run fully automatically can be programmed. Each procedure uses one of the test gases configured in the Test Gas Table (see "Configuring test gases (Test Gas Table)", page 39).

Programming defines which measuring component is to be adjusted or validated with the procedure and which adjustment or validation function is to be used. Several components can be adjusted in one function.

### 5.3.2 Start options

- Manual start:  
Use menu **Operator commands** (see "Start options", page 45).
- Automatic start (in regular intervals):  
Use a long-term timer in the start conditions (see "Technical Information BCU").
- Remote-controlled start:  
Control the value of a Boolean variable (VBVi) with a digital input (see "Technical Information BCU").
- Programmed start conditions:  
Calculate the value of a Boolean variable (BVli) with a formula (see "Technical Information BCU").

For representation of the adjustment and validation results (see "Technical Information BCU").

### 5.3.3 Programming automatic adjustments/validations

1. Menu: Call up **BCU/Parameter/Adjustment/Validation**.

Adjustment / validation													
<input type="checkbox"/> Live view													
<div style="display: flex; justify-content: space-around;"> <span>Mark</span> <span>Edit</span> </div>													
①	②	③	④	⑤	⑥								⑦
Index	Name	Autom	Time	Date	Comp. 1	Comp. 2	Comp. 3	Comp. 4	Comp. 5	Comp. 6	Comp. 7	Comp. 8	Next [Index]
1	Val. zero p.	<input type="checkbox"/>			s1mv1	s1mv2	s1mv3						
2	Adj. zero p.	<input type="checkbox"/>			s1mv1	s1mv2	s1mv3						
3	Val. ref. p.	<input type="checkbox"/>			s1mv1	s1mv2	s1mv3						
4	Adj. ref. p.	<input type="checkbox"/>			s1mv1	s1mv2	s1mv3						
5		<input type="checkbox"/>											
6		<input type="checkbox"/>											
7		<input type="checkbox"/>											
8		<input type="checkbox"/>											

Figure 24: Menu Adjustment / Validation – Table (example)

- ① Index number of the adjustment or validation procedure
  - ② Programmed name
  - ③  = automatic starts activated
  - ④ Start time of next automatic function
  - ⑤ Start date of next automatic function
  - ⑥ Component X that will be addressed by the respective function
  - ⑦ Number of the next function to start automatically (only when procedures are chained)
2. Deactivate **Live view**.
  3. Select the desired Table rows.
  4. Select **Edit**.

The screenshot shows a software interface titled "Adjustment / validation". It contains several sections:

- Index:** A text input field with the value "1" and a circled 1 next to it.
- Name:** A text input field with the value "Val. zero p." and a circled 2 next to it.
- Automatic:** A section with several input fields:
  - Start time [hh:mm]: A text input field with a circled 3 next to it.
  - Start date [yy-mm-dd]: A text input field with a circled 4 next to it.
  - Period: A dropdown menu showing "1" and "Hour", with a circled 5 next to it.
  - active: A checkbox with a circled 6 next to it.
  - Two empty text input fields with circled 7s next to them.
- Component Table:** A table with 8 rows (Component 1 to Component 8) and 6 columns:
  - Tag / name (8): Text input fields with values "s.lmv1", "s.lmv2", "s.lmv3", and empty fields for 4-8.
  - Name (9): Empty text input fields.
  - Function (10): Dropdown menus with "Validate zero point" selected for components 1-3, and empty for 4-8.
  - Test gas time (11): Text input fields with value "0" for all components.
  - Test gas name (12): Empty text input fields.
  - Execution pos. (13): Dropdown menus.
- Summary Fields:**
  - Test gas time (14): Text input field with value "0".
  - Mess. time (15): Text input field with value "5".
  - Calc. time (16): Text input field with value "5".
  - Sample gas time (17): Text input field with value "60".
- next Adj./Vol. [Index] (18):** A dropdown menu.
- Buttons:** "Save", "Cancel", and navigation arrows (< >).

Figure 25: Menu Adjustment / Validation – Edit (example)

- ① Index number of the adjustment or validation procedure
- ② Procedure name (freely selectable text)

Settings for automatic start of this procedure:

- ③ Time of first start of this procedure (format: hh:mm = Hours:Minutes)
- ④ Date of first start of this procedure (format: yyj-mm-dd = Year-Month-Day)
- ⑤ Time interval in which this procedure regularly starts automatically (hours, days or weeks).
- ⑥  = starts are activated (time-controlled starts).
- ⑦ The fields below start time and start date show the next start.

Component X (up to 8 components can be processed by one procedure):

- ⑧ Tag of component
- ⑨ Name of component in Sensor module
- ⑩ Function selected for this component<sup>1</sup>
- ⑪ Flush time set from the test gas settings (information)
- ⑫ Name of test gas from the test gas settings (information)
- ⑬ Sequence for procedure execution<sup>2</sup>
- ⑭ Test gas flush time for this adjustment/validation procedure<sup>3</sup>
- ⑮ Duration of measurements (seconds)<sup>4</sup>
- ⑯ Internal processing duration (drift calculation, data storage)
- ⑰ Flush time with sample gas after the adjustment (seconds)<sup>5</sup>
- ⑱ If required: Index number of the procedure to be started automatically after this procedure.<sup>6</sup>

- 1 When the same function is selected for all components and the same test gas is planned, the function is executed simultaneously for all components during the procedure. Otherwise the functions are executed sequentially during the procedure.
- 2 Functions with identical execution position run at the same time.
- 3 When the same test gas is used for all functions: The longest of the individual test gas flush times (used automatically by the procedure). Otherwise: "0" (= the individual test gas flush times are valid).
- 4 The mean value of measured values during the measuring time is used as actual value of the measurement.
- 5 The procedure first has the status completed after this flush time.
- 6 Starts immediately after the end of this procedure.

## 6 Tests and settings

### 6.1 Information



#### NOTE

SOPAS ET is required for the tests and settings: see "Software SOPAS ET", page 38.

### 6.2 Setting the time

Date and time setting is synchronized to that of the PC.

- ▶ Open SOPAS ET and connect to the MARSIC200.
- ▶ Menu: Parameter/Device.
- ▶ Click "Time XX:XX" to transfer the time setting of the PC to MARSIC200.

Figure 26: BCU: Internal clock

### 6.3 Interfaces (I/O)

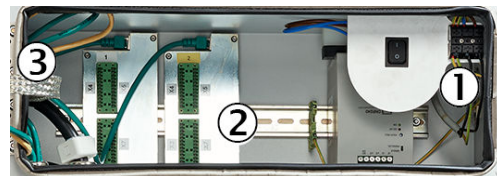

- ① Power voltage connection at terminal strip
- ② Signal connections (I/O)
- ③ Distributor board with Ethernet for MPR (option), Modbus, service interface (LAN)

For ② "Signal connections": See the wiring diagram in the system documentation for the terminal plan.

Ref. ③ "Modbus": Setting the IP address, see "Operating Instructions BCU" and "Technical Information BCU".

#### 6.3.1 Digital inputs

Menu: Parameter/I/O/Digital input

Select the digital output to be tested and click "Test". A LED (green) is on when the selected digital input is active.

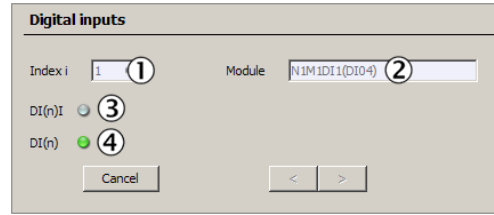

Figure 27: Test digital inputs

Significance	
①	Number of selected input.
②	Topographic addressing.
③	[State] Computed value of [Source] (“Inverted” is taken into consideration).
④	[Source] LED is off: Physical contact open. LED is on: Physical contact closed.

### 6.3.2 Digital outputs

Menu: Parameter/I/O/Digital output

Select the digital output to be tested and click “Test”.

The digital output can be activated or deactivated for the function check using the checkmark (see “Test value” in the Figure below).

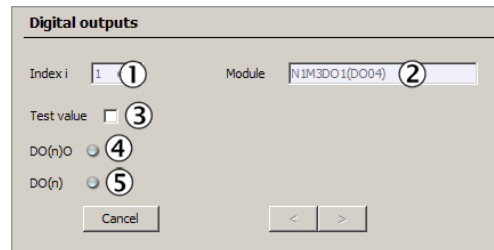

Figure 28: Test of digital outputs

Significance	
①	Number of selected output.
②	Topographic addressing.
③	No checkmark: Physical contact should be open. Checkmark: Physical contact should be closed.
④	[State] LED is off: Relay energized. LED is on: Relay de-energized.
⑤	[Source] LED is off: Program specification: Physical contact should be open. LED is on: Program specification: Physical contact should be closed.

Set the checkmark next to the Test value checkbox.

The status of the LEDs changes.

Use an ohmmeter to check the status of the relay outputs on X4 (DO 1-4) and X5 (DO 5-8).

If relay outputs do not function, the I/O modules must be exchanged because they cannot be repaired onsite.



### 6.3.3 Analog outputs

Menu: Parameter/I/O/Analog output

This menu checks the analog outputs.

Select the analog output to be tested and click “Test”.

Figure 29: Test of analog outputs

	Significance
①	Number of selected output.
②	Topographic addressing.
③	Test value. Input: Nominal value of the current to be output.
④	Actual value of the current output.
⑤	Output value converted to the physical unit.

- ▶ Select the analog output to be tested and click “Test”. The current test current is shown in the menu.
- ▶ To change the test current on the analog output, modify the value “Test value [phys. unit]”. The test value [phys. unit] always refers to the active output range of the analog output. To check the settings for the analog outputs, go to: “BCU/Parameter/I/O/Analog outputs”.
- ▶ Use an ammeter to check the analog output values directly on plug X7.

Example (with 2 measuring ranges set):

Range 1 = 0 - 200 ppm

Range 2 = 0 - 400 ppm

LiveZero = 4 mA

Test value [phys. unit]	Test current on analog output
0 ppm	4 mA
100 ppm	12 mA
200 ppm	20 mA
300 ppm	16 mA
400 ppm	20 mA

## 6.4 Adapting the hardware



### NOTE

You have to perform this work when deviations of the analog signal are detected during the hardware check. Analog inputs and/or analog outputs must then be adapted.

Tools required
Ammeter
Constant current source or analog output

### 6.4.1 Setting analog interfaces

1. Connect the I/O module.
2. Login as "Service" on the control unit.
3. Measuring screen "8" starts.
4. Configure the analog displays with "AI01" and "AI02".
5. Select menu Parameter/Variables and functions/Real values (Rvi).
6. If "Live view" is activated at the top left: Click checkmark off.
7. Mark "RV1" and then select "Edit".
8. Enter "15" as start value.
9. "Save" the input.
10. Select menu Parameter/IO/ Analog outputs.  
(Selecting this action sends the setpoint value 15 mA on the analog outputs of the I/O module).
  - o Select and edit the 4 defined analog outputs
  - o Source = RV1
  - o Null/Zero = 0 mA
  - o Measuring range 1 active = yes
  - o Measuring range 1: Start value = 0
  - o Measuring range 1: End value = 20
11. "Save" the configuration.
12. Select menu Diagnosis/IO module.
  - o Activate "Configuration view".
  - o Activate "Reset adjustment value".
  - o Wait until the green LED goes on.
  - o Reset "Live view" again.  
(This action resets all parameters in the I/O module to start values).
13. Select Menu Maintenance/Tests/Adjustment IO-module 1.
  - ▷ Mark index 1 to index 6 and then select Test.
14. Measure the current on pin 5 and pin 6 on X7.  
Setpoint: 15 mA.
  - o Enter the measured value as "AO1".  
The measured value must now be 15 mA.
  - o Enter "0" as test value.  
This saves the input value as final value.  
Attention! Only "0" must remain as test value when leaving the menu.
15. Repeat this procedure with pin 7 / pin 8 on X7 and test value "AO2".
16. Repeat this procedure with pin 9 / pin 10 on X7 and test value "AO3".
17. Repeat this procedure with pin 11 / pin 12 on X11 and test value "AO4".
18. Fit jumpers on X7:
  - ▷ From pin 12 to pin 4
  - ▷ From pin 11 to pin 2
  - ▷ From pin 10 to pin 3
  - ▷ From pin 9 to pin 1
  - o Measured values appear on the display in both analog inputs.
  - o Enter value "15" for "AI1" in the input menu.
  - o The display must now show the value 15 mA.
  - o Set the test value for AI1 to 0 again.
  - o Repeat the procedure for the 2nd analog input with "AI2".
 This completes the adjustment of the analog inputs and outputs.

## 6.5 Configuring measured values

### Procedure

1. Menu: Call up BCU/Parameter/Measured values (MVi).

Measured values (MV)

Live view

Mark Edit

Index i	Enabled	Aux. value	Test pt. autom.	Name	Range start	Range end	Unit	Limit 1	Type	Limit 2	Type
1	<input checked="" type="checkbox"/>	<input type="checkbox"/>	<input type="checkbox"/>	NO	0.0	200.0	mg/m3	0.0	Off	0.0	Off
2	<input checked="" type="checkbox"/>	<input type="checkbox"/>	<input type="checkbox"/>	SO2	0.0	2500.0	ppm	0.0	Off	0.0	Off
3	<input checked="" type="checkbox"/>	<input type="checkbox"/>	<input type="checkbox"/>	H2S	0.0	4000.0	ppm	0.0	Off	0.0	Off
4	<input checked="" type="checkbox"/>	<input checked="" type="checkbox"/>	<input type="checkbox"/>	Druck	0.0	1500.0	MPa	0.0	Off	0.0	Off
5	<input type="checkbox"/>	<input type="checkbox"/>	<input type="checkbox"/>		0.0	0.0		0.0	Off	0.0	Off
6	<input type="checkbox"/>	<input type="checkbox"/>	<input type="checkbox"/>		0.0	0.0		0.0	Off	0.0	Off
7	<input type="checkbox"/>	<input type="checkbox"/>	<input type="checkbox"/>		0.0	0.0		0.0	Off	0.0	Off
8	<input type="checkbox"/>	<input type="checkbox"/>	<input type="checkbox"/>		0.0	0.0		0.0	Off	0.0	Off
9	<input type="checkbox"/>	<input type="checkbox"/>	<input type="checkbox"/>		0.0	0.0		0.0	Off	0.0	Off
10	<input type="checkbox"/>	<input type="checkbox"/>	<input type="checkbox"/>		0.0	0.0		0.0	Off	0.0	Off
11	<input type="checkbox"/>	<input type="checkbox"/>	<input type="checkbox"/>		0.0	0.0		0.0	Off	0.0	Off
12	<input type="checkbox"/>	<input type="checkbox"/>	<input type="checkbox"/>		0.0	0.0		0.0	Off	0.0	Off

Freeze all analog outputs of measured values during an adjustment or validation

Figure 30: Menu “Measured values (MV)” - Table (example)

2. Deactivate Live view.
3. Select the desired Table rows.
4. Select Edit.

Measured values (MV)

Index i  ①

Enable  ②      Auxiliary value  ③      Meas. point automatic active  ④      original  ⑤

Name  ⑥      Measurement range start  ⑦      Measurement range end  ⑧      Unit  ⑨

Formula  ⑩

Limit 1  ⑪      Type  ⑫      Hysteresis  ⑬      Flag  ⑭

Limit 2       Type       Hysteresis       Flag  ⑭

Timeout [s]  ⑮      Flag  ⑯

Measurement mask hold value  ⑰      Measurement mask  ⑱

Fractional digits  ⑲

Save      Cancel      < >

Figure 31: Menu “Measured values (MV)” - Edit (example)

- ① Consecutive number (1 = MV1, 2 = MV2 etc.)
- ②  = the measured value is displayed and output
- ③  = the measured value is not shown on the display (all other usage options remain available)
- ④  = an own “measured value” is created for each measuring point
- ⑤ Configuration of the measured value (MV) relative to name, unit and measured value fare as the source (sensor measured value)
- ⑥ Programmed name of the measured value
- ⑦ Start value of physical measuring range
- ⑧ End value of physical measuring range
- ⑨ Programmed physical unit for the measured value
- ⑩ Formula for assignment or calculation of the measured value
- ⑪ Limit value

- ⑫
    - Off: Limit value not active
    - Overflow (+): The limit value message is active when the measured value is larger than the limit value.
    - Underflow (-): The limit value message is active when the measured value is smaller than the limit value.
  - ⑬ Hysteresis
  - ⑭ This flag is activated for the measured value (“-” in flag means no flag activation) when the measured value is beyond the limit value.
  - ⑮ Programmed time limit value for an internal failure of the measuring signal or the source value for this measured value.
  - ⑯ Activated flag when the time limit value is overflown.
  - ⑰ Start value for using the measured value mask. Is also the output value in the measured value mask range.
  - ⑱ Effective range of the measured value mask. Valid as from the start value; positive or negative value possible.
  - ⑲ Number of decimal places.
5. Make the desired entries.
  6. Select **Save**.

### 6.6 Measuring points - automatic

#### 6.6.1 Function of the measuring points automatic

##### Measuring point switchover

Measuring points are extraction points for sample gas. The “measuring points automatic” allows the BCU to control automatically up to 8 measuring points.

##### Hold function for analog outputs

When the measuring point automatic is activated for a measured value, the measured values of the measuring points (MViMPj) are also provided internally as well as the measured value (MVi). These measured values of the measuring points can be output via the analog outputs. During the measuring time of the measuring point (see "[Measuring points - automatic](#)", page 52), the current measured value measured by MARSIC200 is output as measured value. During the remaining times, the last measured value measured with this measuring point is output as a constant value.



##### NOTE

When the measuring point automatic is activated, an identifier of the current measuring point is shown on the Measuring Screens and on the BCU display.

---

#### 6.6.2 Criteria for measuring point automatic

- One digital output exists for each measuring point in the MARSIC200. The digital output is configured for the measuring point (see “Technical Information BCU”).
- A device is installed outside the MARSIC200 that switches the sample gas path to the measuring point (e.g., a solenoid valve). The associated digital output controls this device.
- At least two measuring points are configured and switched to “active” (see "[Configuring measuring point automatic](#)", page 53).



##### NOTE

Digital outputs for measuring points automatic are controlled using tag MPiS (see “Technical Information BCU”).

---

### 6.6.3 Configuring measuring point automatic

#### Procedure

1. Menu: Call up BCU/Parameter/"Measuring point automatic".

Index i	Enabled	Name	Purge time	Meas. time
1	<input type="checkbox"/>		120	30
2	<input type="checkbox"/>		120	30
3	<input type="checkbox"/>		120	30
4	<input type="checkbox"/>		120	30

Figure 32: Menu "Measuring point automatic" – Table (example)

2. Deactivate Live view.
3. Select the desired Table rows.
4. Select Edit.

Index i: 1 ①

Enable:  ②

Name:  ③

Purge time: 120 ④      Meas. time: 30 ⑤

Save      Cancel      < >

Figure 33: Menu "Measuring point automatic" – Edit (example)

- ① Consecutive number (1 = MP1, 2 = MP2 etc.)<sup>1</sup>
- ②  = this measuring point is used by measuring point automatic
- ③ Name of the measuring point
- ④ Wait time after switching to this measuring point<sup>2</sup>
- ⑤ Measuring time with the sample gas from this measuring point<sup>3 4</sup>

1 Defines the sequence of the measuring points during switchover.

2 Criterion: Response time + T<sub>90</sub> %.

3 Select as required.

4 Flush time + measuring time = activation time of the digital output = total time for this measuring point.

5. Make the desired entries.
6. Select Save.

## 6.7 Backup of settings

Current parameter settings can be stored in internal storage.

Backup files can be created in the device at any time. Each module has its own backup. A maximum of two backups are stored on the sensor modules and the BCU. The first backup is overwritten when the third backup is created. This means only the last two backups are saved.

The saved data are marked with the date and time.

Displaying the data of the new backup can take up to one minute.

**Creating a backup copy**

- ▶ Go to menu BCU/Maintenance/User settings.
- ▶ Click “Save”.

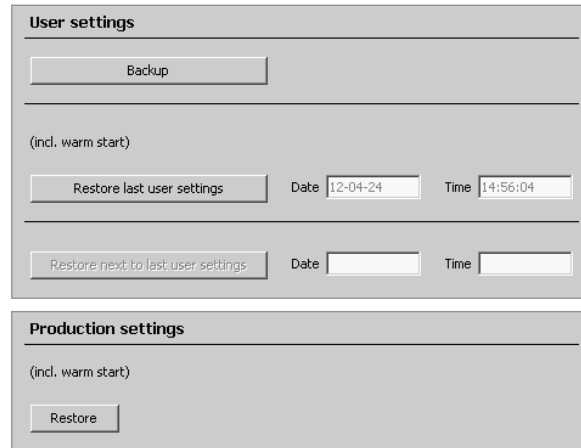

Figure 34: Backup

**Restoring the SW**

Only data marked with the time and date of the backup can be restored. Either the last or the second last backup can be chosen to load the device data. After the data have been loaded, the module carries out a restart (warm start) automatically so the loaded data are then used during processing. The means the operating data existing before the restore are irretrievably deleted.

- ▶ Go to menu BCU/Maintenance/User settings (Maintenance/Backup/Restore). Menu, see above.

**Restoring factory settings**

The factory settings can be restored.

- ▶ Go to menu BCU/Maintenance/User settings (Maintenance/Backup-Restore) and click “Restore” (production settings).

**Backup on the PC**

Module parameters can be saved and then restored later using SOPAS ET.

- ▶ Select the module in the SOPAS ET project tree.
- ▶ Export the device data to the PC with “Project/Export device”.

It is recommended to integrate the module type, device and date in the file names to simplify later identification. For example: MARSIC\_11018001\_2014-12.sdv.

A \*.sdv file is created.

**Restoring data from the PC**

Only parameters configured at Service level are overwritten.

- ▶ Restore the \*.sdv files with “Edit/Load device data ...”.
- ▶ Search for \*.sdv files and click “Continue”.
- ▶ Select a user level and enter the associated password.

All parameters that can be modified with the selected user level are overwritten.

## 7 Technical data



**NOTE**

The technical data depend to some extent on the individual equipment of your device.

- ▶ See the enclosed System Description for the configuration of your device.

### 7.1 Dimensional drawings

#### 7.1.1 Dimensional drawing of sample conditioning

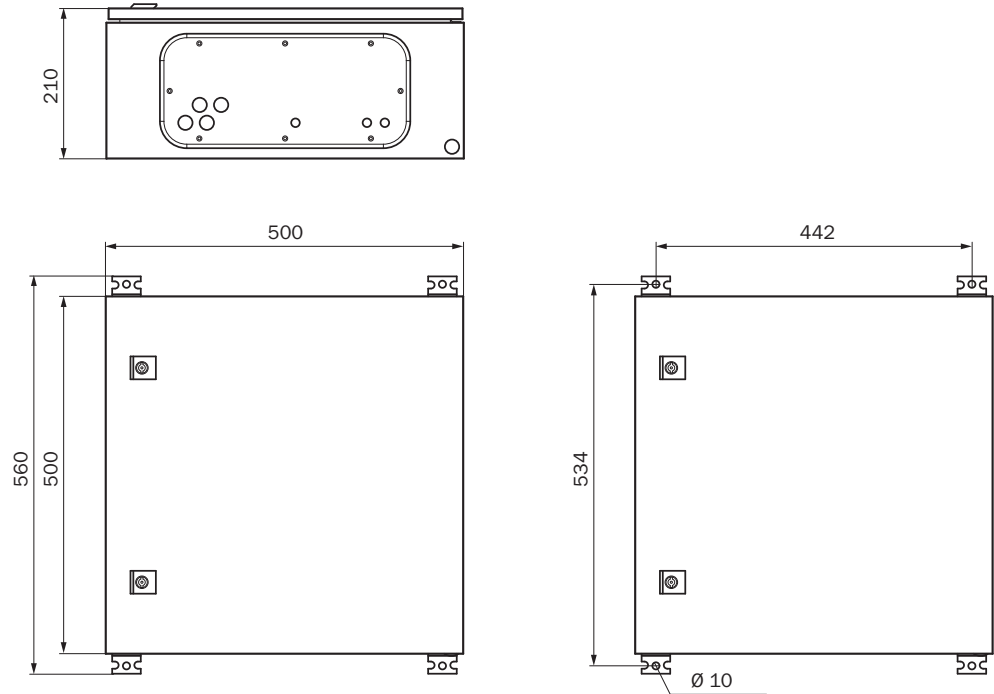

**NOTICE**

Observe clearances:

- Bottom: 20 cm
- Right: 30 cm

7.1.2 Dimensional drawing of distribution unit

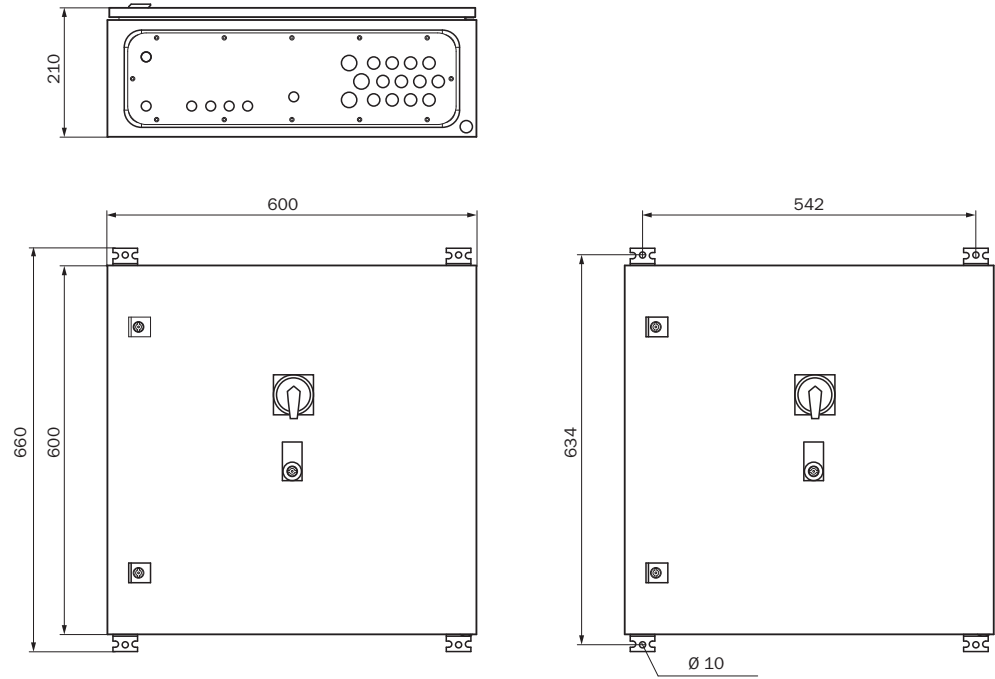

**NOTICE**

Observe clearance:

- Bottom: 20 cm



7.1.3 Dimensional drawing of analyzer

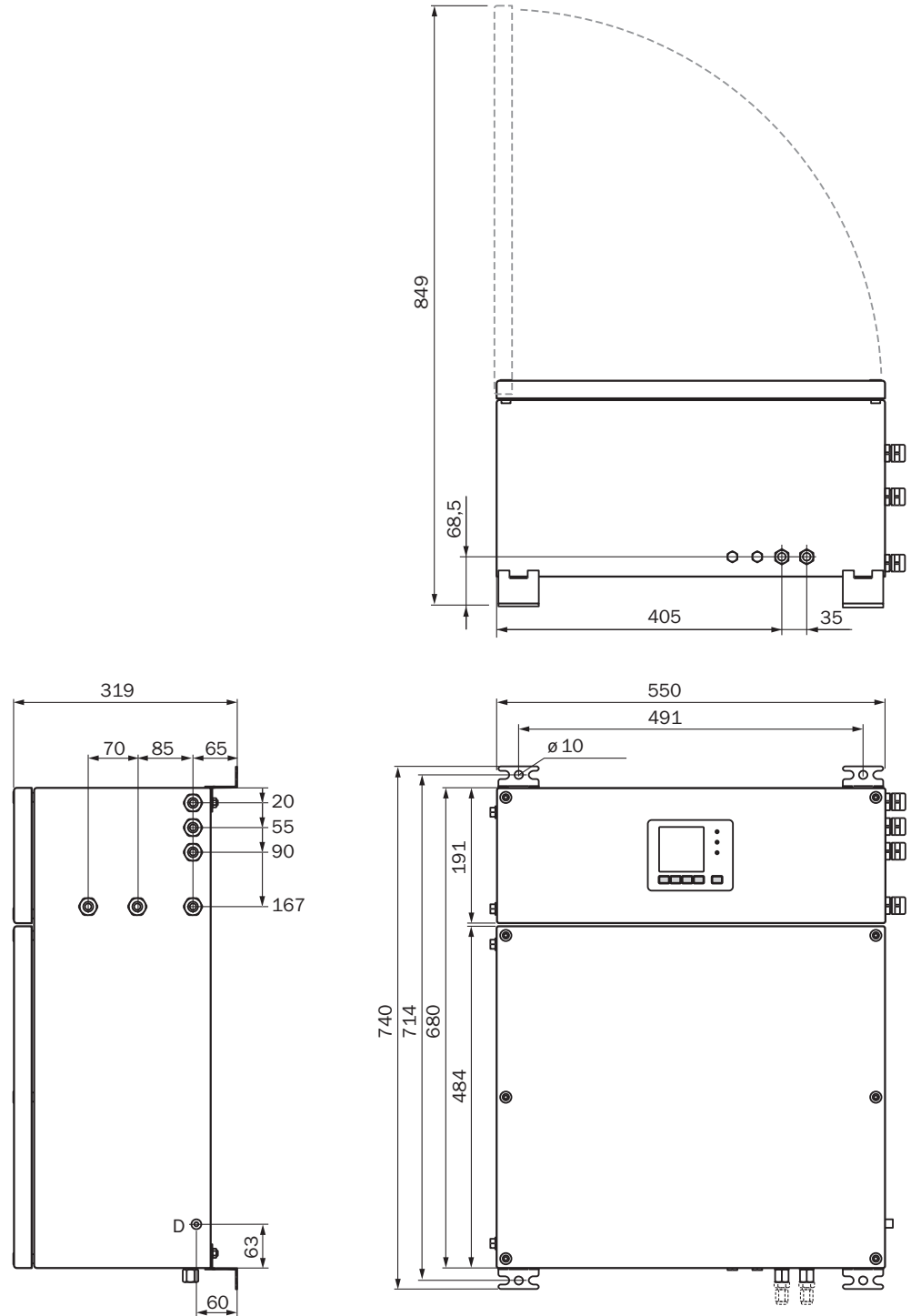

**NOTICE**

Observe clearance:

- Right: 10 cm
- Bottom: 20 cm

7.1.4 Dimensional drawing of sampling probe

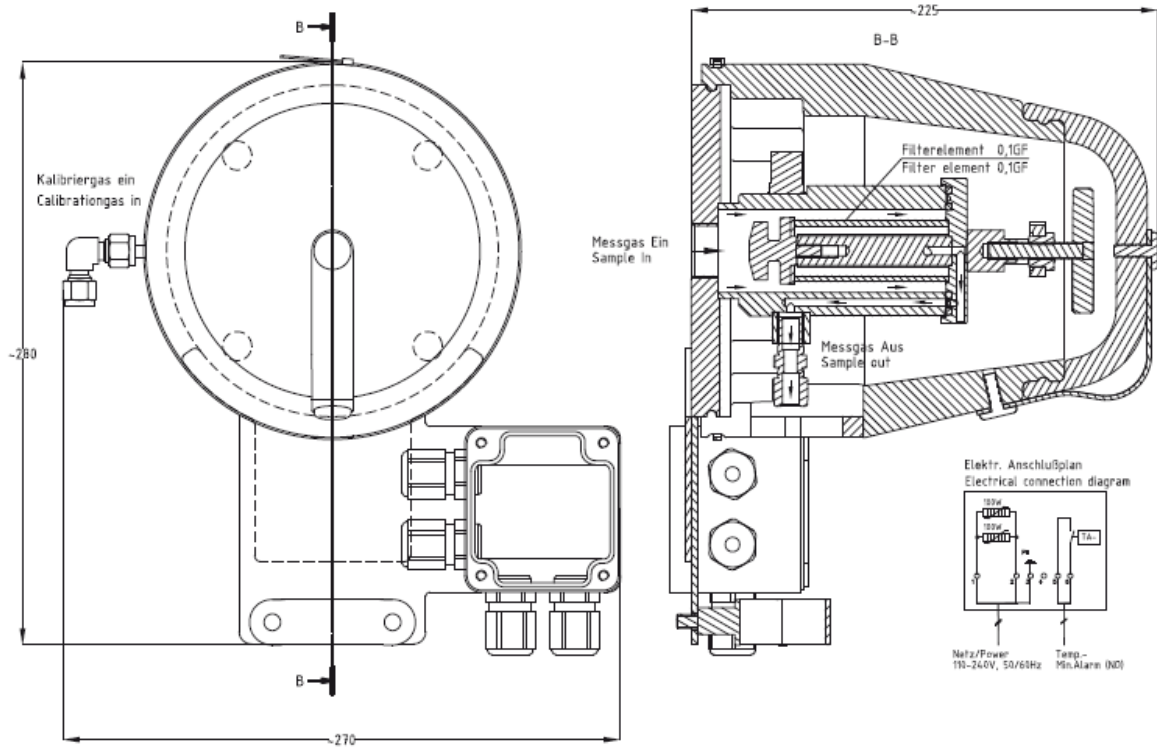

Probe tube length	Part number
400	5329476
600	5329477
800	5329478

7.1.5 Sample gas line, heated

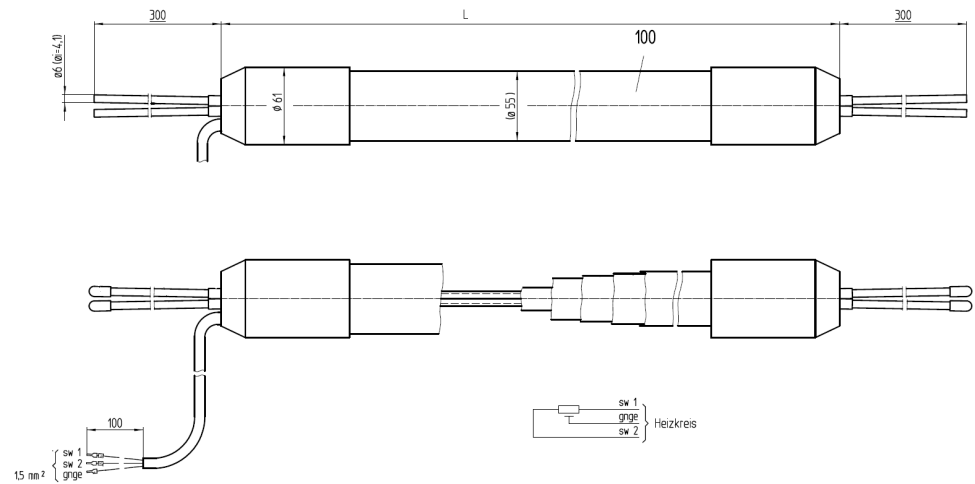

Figure 35: Technical drawing - heated sample gas line

## 7.2 Gas flow diagram

### SINGLE version distribution unit for one measuring point

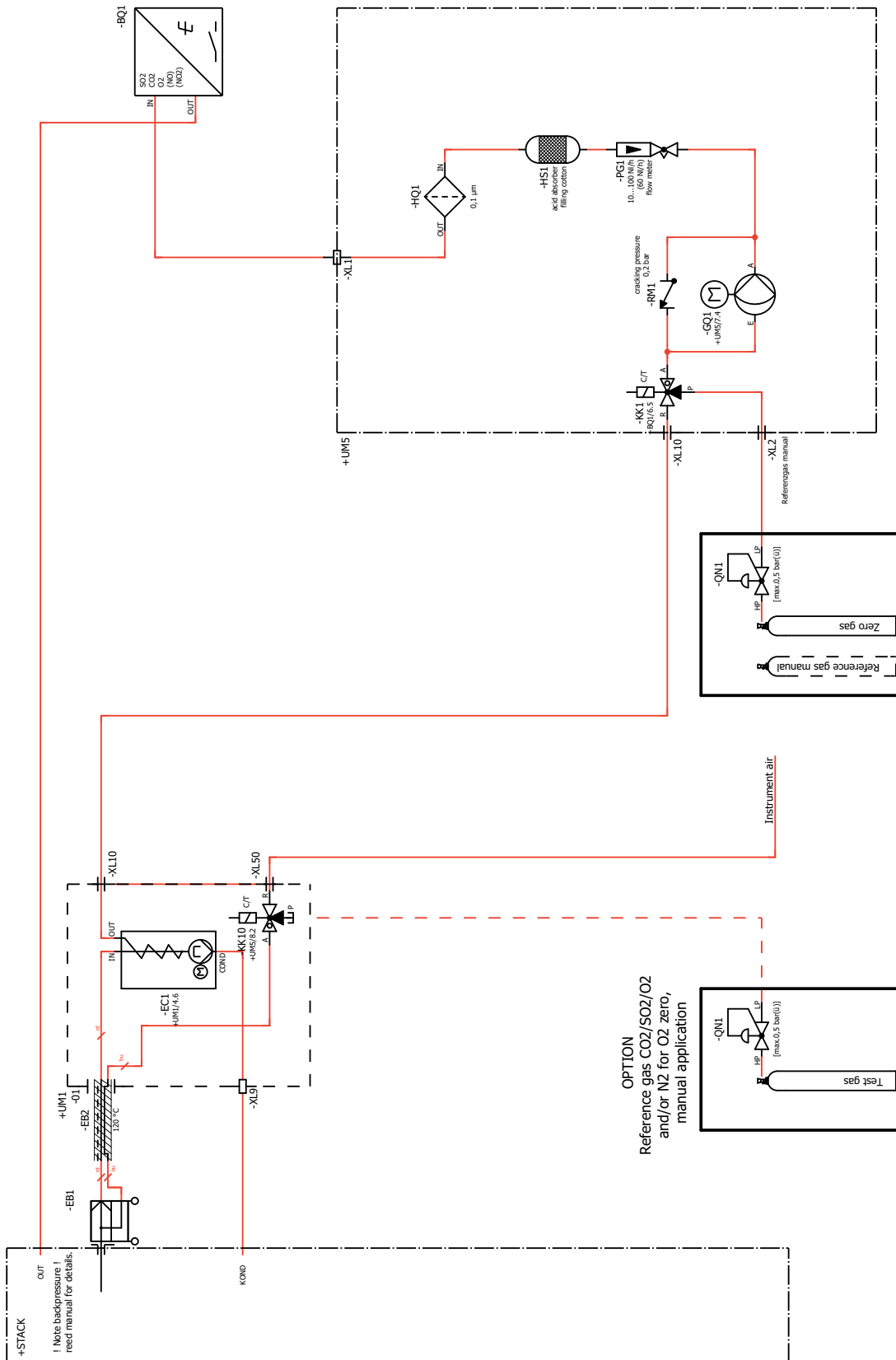

Figure 36: Gas flow diagram

MULTI version distribution unit for two to four measuring points

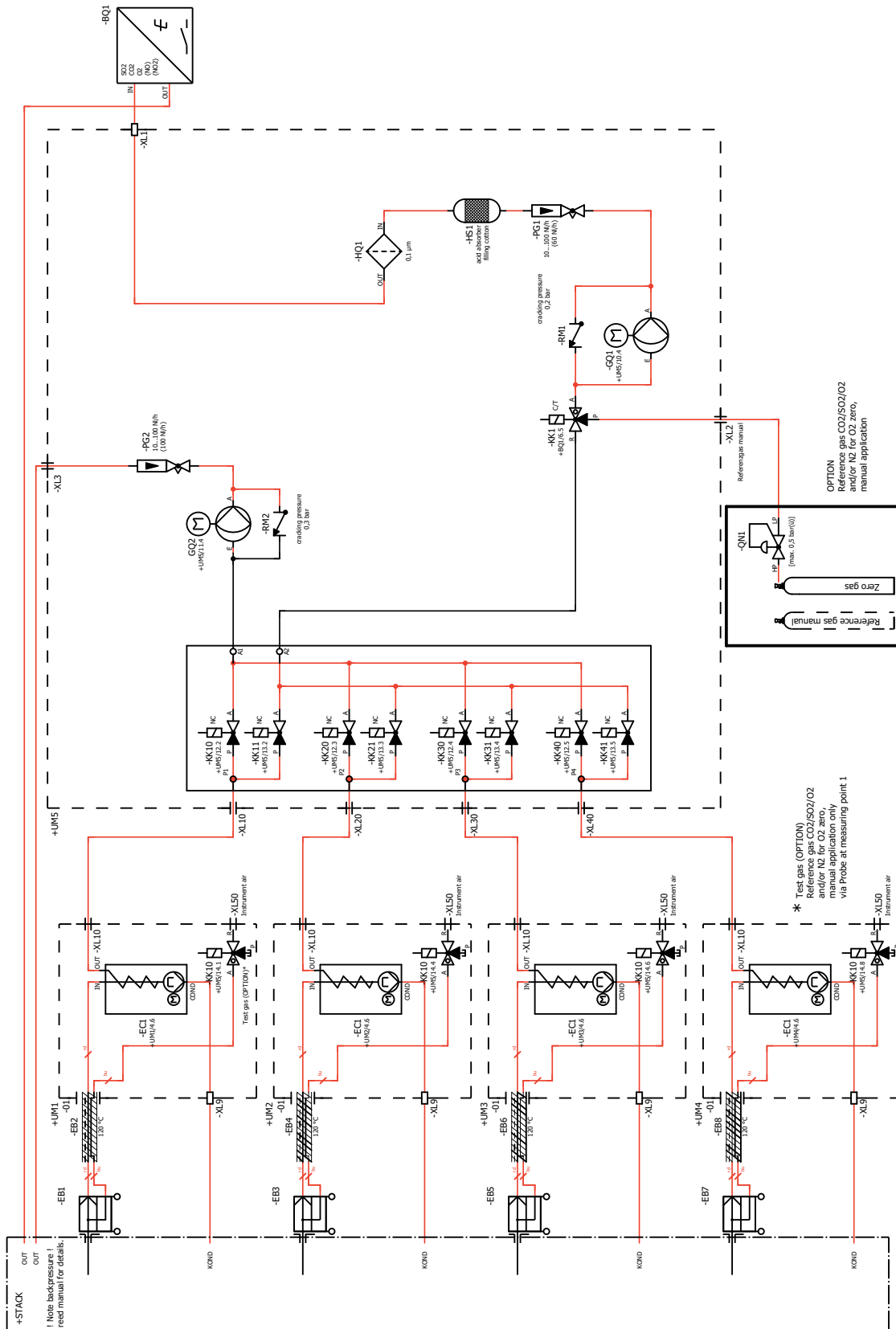

Figure 37: Gas flow diagram

### 7.3 Measuring parameters

Variant	Components
DeSO <sub>x</sub>	SO <sub>2</sub> , CO <sub>2</sub> , optional O <sub>2</sub>
Full configuration	SO <sub>2</sub> , CO <sub>2</sub> , NO, NO <sub>2</sub> , optional O <sub>2</sub>

Number of measured variables	
Number of measured variables	Max. 5

Measuring method	
Measuring method	Cold-extractive

Sample volume	
Sample volume	60 ... 100 l/h

Spectral range	
Spectral range	UV, VIS

Component	Measuring ranges
SO <sub>2</sub>	0 ... 100 ppm; 0 ... 500 ppm
CO <sub>2</sub>	0 ... 25% by volume
O <sub>2</sub>	0 ... 21%volume
NO	0 ... 300 ppm; 0 ... 1500 ppm
NO <sub>2</sub>	0 ... 200 ppm; 0 ... 500 ppm

Measuring point switchover	
Measuring point switchover	Max. 4 measuring points

Measured value characteristics	
Measuring precision	< 1% of the respective full scale value
Detection limit	< 0.5% of the respective full scale value
Sensitivity drift	< 2% of the respective full scale value per week
Zero drift	< 2% of the respective full scale value per week
Span drift	< 2% of the respective full scale value per week
Setting time t <sub>90</sub>	15 ... 30 s, total active measuring path as from sampling (With advance extraction with several measuring points)

### 7.4 Ambient conditions

Ambient conditions in operation	
Installation location	Below deck
Ambient temperature	+5 ... +45 °C
Relative humidity	< 90% (without condensate)
Air pressure	900 ... 1100 hPa
Degree of protection	IP 54

Ambient conditions in storage	
Ambient temperature	-20 ... +70 °C
Relative humidity	< 90% (without condensate)

## 7.5 Sample gas conditions

Sample gas at the measuring point	Characteristics
Process temperature	10 ... 550 °C
Sample gas temperature	200 °C
Process pressure	-90 ... +200 hPa relative
Dust load	< 200 mg/m <sup>3</sup>

## 7.6 Design as wall enclosure

Sampling probe	
Ambient temperature	-25 ... 65 °C
Working temperature	+180 °C, self-regulating
Filter element	Fine filter 0.1 µm
Power supply	115 V / 230 V
Power consumption	Start: 400 VA, operation: 100 VA
Degree of protection	IP 54
Weight	Approx. 7.5 kg
Dimensions	<a href="#">see "Dimensional drawing of sampling probe", page 58</a>

Design as wall enclosure	
Design	3 x wall enclosure <ul style="list-style-type: none"> <li>• Sample conditioning</li> <li>• Distribution unit</li> <li>• Analyzer</li> </ul>
Material, general	Steel plate according to EN 10130
Dimensions	<a href="#">see "Dimensional drawings", page 55</a>
Installation	Wall fitting
Weight	<ul style="list-style-type: none"> <li>• Sample conditioning: Approx. 27 kg</li> <li>• Distribution unit: Approx. 30 kg</li> <li>• Analyzer: Approx. 37 kg</li> </ul>
Materials with media contact	<ul style="list-style-type: none"> <li>• PTFE</li> <li>• Viton B</li> <li>• PVDF</li> <li>• Stainless steel 1.4571</li> <li>• Platinum, nickel</li> <li>• Aluminum</li> <li>• CaF<sub>2</sub></li> </ul>
Degree of protection	<ul style="list-style-type: none"> <li>• Sample conditioning: IP54</li> <li>• Distribution unit: IP54</li> <li>• Analyzer: IP54</li> </ul>

## 7.7 Sample gas line, heated

Sample gas line	
Ambient temperature	-20 ... 80 °C
Working temperature	+120 °C
Heating	Self-regulating parallel heater line
Power supply	115 V / 230 V
Power consumption	60 W/m at 10 °C
Dimensions	<a href="#">see "Sample gas line, heated", page 58</a>
Degree of protection	IP 54
Protection class	I

## 7.8 Interfaces and protocols

Operation and interfaces	
Operation	Via LC-Display or SOPAS ET software, several operating levels, password-protected
Display and input	Black-and-white foiled screen with function buttons Status LEDs: <ul style="list-style-type: none"> <li>• "Power"</li> <li>• "Malfunction"</li> <li>• "Maintenance request"</li> </ul>
Remote control	Ethernet (TCP/IP): <ul style="list-style-type: none"> <li>• Connector: RJ 45</li> <li>• Type: TCP/IP Peer-to-Peer.</li> <li>• Method: 10 MBit half-duplex</li> </ul> Modbus
Remote maintenance	SICK MPR (optional)
PC operation	SOPAS ET via Ethernet

Analog outputs	
Number	8
Reference potential	Potential-free (electrically isolated)
Signal range	0 ... 24 mA
Residual ripple	0.02 mA
Resolution/precision	0.1% (20 µA)
Accuracy	0.25% of full-scale value
Maximum load	500 Ω
Maximum output voltage	15 V
Start or error state	Adjustable

Analog inputs	
Number	2
Reference potential	GND
Input signal	0 ... 20 mA
Highest allowable input signal	30 mA
Overcurrent protective device	±1000 mA

Analog inputs	
Input load	50 $\Omega$
Transducer precision	0,5 %

Digital inputs	
Design	Optical coupler
Number	8
Switching range	18 ... 42 V
Highest allowable voltage	$\pm 50$ V DC

Digital outputs	
Number	16
Contact type:	1-pole changeover switch, 3 connections
Contact load:	See Table below
Highest allowable voltage	$\pm 50$ V DC

Table 7: Maximum load per relay switching contact

Application area		AC voltage	DC voltage	Current
Standard:		Max. 30 VAC	Max. 48 VAC	Max. 500 mA
CSA	Either	Max. 30 VAC	Max. 48 VAC	Max. 50 mA
	or	Max. 15 VAC	Max. 24 VAC	Max. 200 mA
	or	Max. 12 VAC	Max. 18 VAC	Max. 500 mA

**NOTICE**

Only use discharging diodes to connect inductive loads (e.g., relays, solenoid valves) to the switching outputs.

- For inductive loads: Check that discharging diodes are fitted.
- If this is not the case: Install external discharging diodes.

## 7.9 Energy supply

Power supply	
Supply voltage	115/230 VAC, 50/60 Hz Deviating power supply via upstream transformer
Current	8 A (with 230 V)
Power consumption	Power consumption
<ul style="list-style-type: none"> <li>• Sampling probe</li> <li>• Sample gas line</li> <li>• Sample conditioning</li> <li>• Distribution unit</li> <li>• Analyzer</li> </ul>	<ul style="list-style-type: none"> <li>• 400 VA</li> <li>• 60 VA/m</li> <li>• 150 VA</li> <li>• 200 VA (1 MPI), 300 VA (2 ... 4 MPI)</li> <li>• 300 VA</li> </ul>

Power input, complete system (max. for each 5 m sample gas line)			
Number of measuring points	Power consumption	Current (230 VAC)	Current (115 VAC)
1	1400 VA	6 A	12 A
2	2300 VA	10 A	20 A
3	3200 VA	14 A	28 A



Power input, complete system (max. for each 5 m sample gas line)			
4	4000 VA	17 A	35 A

Connections	
Connections, analyzer	<ul style="list-style-type: none"> <li>Signal cable, 7-wire, 1.5 mm<sup>2</sup>, shielded, e.g., Marineline (Sick Part No. 6056230)</li> <li>Power cable, 3-wire, min. 1.5 mm<sup>2</sup>, e.g., Marineline (Sick Part No. 6056215)</li> </ul>
Distribution unit	<ul style="list-style-type: none"> <li>Signal cable, 7-wire, 1.5 mm<sup>2</sup>, shielded, e.g., Marineline (Sick Part No. 6056230)</li> <li>Signal cable, 4-wire, 0.75 mm<sup>2</sup>, shielded, e.g., Marineline (Sick Part No. 6056229)</li> <li>Power cable, 3-wire, min. 1.5 mm<sup>2</sup>, e.g., Marineline (Sick Part No. 6056215)</li> </ul>
Sample conditioning	<ul style="list-style-type: none"> <li>Signal cable, 4-wire, 0.75 mm<sup>2</sup>, shielded, e.g., Marineline (Sick Part No. 6056229)</li> <li>Power cable, 3-wire, min. 1.5 mm<sup>2</sup>, e.g., Marineline (Sick Part No. 6056215)</li> </ul>
Sample gas line	<ul style="list-style-type: none"> <li>Power cable, 3-wire, 1.5 mm<sup>2</sup></li> </ul>
Sampling probe	<ul style="list-style-type: none"> <li>Signal cable, 4-wire, 0.75 mm<sup>2</sup>, shielded, e.g., Marineline (Sick Part No. 6056229)</li> <li>Power cable, 3-wire, min. 1.5 mm<sup>2</sup>, e.g., Marineline (Sick Part No. 6056215)</li> </ul>

## 7.10 Emissions

Emissions	
Condensate	For water vapour-saturated exhaust gas (e.g., after exhaust gas washer): Approx. 2 liters of condensate per week

## 7.11 Torques for screw fittings

A medium total friction coefficient of  $\mu=0.12$  is assumed in the specification of torques. This means that the screws are installed lightly oiled.

Analyzer	Property class	Torque
Analyzer door screw fitting	A2-50	3 Nm
Analyzer enclosure 4 screws M8 bolts and bracket on analyzer enclosure	8.8	23.1 Nm
	10.9	34 Nm
	12.9	39.6 Nm
	A2/4-50	7.1 Nm
	A2/4-70	16 Nm
A2/4-80:9	22 Nm	
FINOR 3 screws base plate		4 Nm
Ground screw FINOR		3 Nm
Ground screw analyzer		3 Nm
Gas module 4 screws base plate		3 Nm
Complete analyzer module, 7 black screws		9 Nm

Sample conditioning and distribution unit	Torque
Insertion of sample gas line 2 clamping screws	1.5 Nm
Insertion of sample gas line 4 frame screws	1.5 Nm
Solenoid valve M4	2 Nm
Cover of solenoid valve M2.5	0.35 Nm
Pump M4	2 Nm
Sample gas cooler M6	6 Nm
Enclosure, complete	See above "Analyzer"

## 7.12 Tube connections

Connection	Dimension
Sample gas connections	Swagelok DN 4/6
Instrument air	Hose coupling DN 4/6
Test gas	Hose coupling DN 4/6

## 7.13 Sample gas conditions



### NOTICE

Risk of contamination of analyzer

- ▶ Observe the specified quality of the instrument air
- ▶ If required, provide for instrument air conditioning

Gas	Quality	Inlet pressure	Flow rate
Instrument air	Particle size max. 1 $\mu\text{m}$ Oil content max. 0.1 mg/m <sup>3</sup>	Max. +300 hPa	Typically 60 l/h
Zero point gas	Nitrogen 5.0	Max. +300 hPa	Typically 60 l/h
Span gas	External span gas Precision: $\pm 2\%$ Concentration: 80% ... 100% of measuring range The span gas must comply with the specifications of the standards to be applied (e.g., MARPOL Annex VI)	Max. +300 hPa	Typically 60 l/h



**Australia**

Phone +61 (3) 9457 0600  
1800 33 48 02 – tollfree  
E-Mail sales@sick.com.au

**Austria**

Phone +43 (0) 2236 62288-0  
E-Mail office@sick.at

**Belgium/Luxembourg**

Phone +32 (0) 2 466 55 66  
E-Mail info@sick.be

**Brazil**

Phone +55 11 3215-4900  
E-Mail comercial@sick.com.br

**Canada**

Phone +1 905.771.1444  
E-Mail cs.canada@sick.com

**Czech Republic**

Phone +420 234 719 500  
E-Mail sick@sick.cz

**Chile**

Phone +56 (2) 2274 7430  
E-Mail chile@sick.com

**China**

Phone +86 20 2882 3600  
E-Mail info.china@sick.net.cn

**Denmark**

Phone +45 45 82 64 00  
E-Mail sick@sick.dk

**Finland**

Phone +358-9-25 15 800  
E-Mail sick@sick.fi

**France**

Phone +33 1 64 62 35 00  
E-Mail info@sick.fr

**Germany**

Phone +49 (0) 2 11 53 010  
E-Mail info@sick.de

**Greece**

Phone +30 210 6825100  
E-Mail office@sick.com.gr

**Hong Kong**

Phone +852 2153 6300  
E-Mail ghk@sick.com.hk

**Hungary**

Phone +36 1 371 2680  
E-Mail ertekezes@sick.hu

**India**

Phone +91-22-6119 8900  
E-Mail info@sick-india.com

**Israel**

Phone +972 97110 11  
E-Mail info@sick-sensors.com

**Italy**

Phone +39 02 27 43 41  
E-Mail info@sick.it

**Japan**

Phone +81 3 5309 2112  
E-Mail support@sick.jp

**Malaysia**

Phone +603-8080 7425  
E-Mail enquiry.my@sick.com

**Mexico**

Phone +52 (472) 748 9451  
E-Mail mexico@sick.com

**Netherlands**

Phone +31 (0) 30 229 25 44  
E-Mail info@sick.nl

**New Zealand**

Phone +64 9 415 0459  
0800 222 278 – tollfree  
E-Mail sales@sick.co.nz

**Norway**

Phone +47 67 81 50 00  
E-Mail sick@sick.no

**Poland**

Phone +48 22 539 41 00  
E-Mail info@sick.pl

**Romania**

Phone +40 356-17 11 20  
E-Mail office@sick.ro

**Russia**

Phone +7 495 283 09 90  
E-Mail info@sick.ru

**Singapore**

Phone +65 6744 3732  
E-Mail sales.gsg@sick.com

**Slovakia**

Phone +421 482 901 201  
E-Mail mail@sick-sk.sk

**Slovenia**

Phone +386 591 78849  
E-Mail office@sick.si

**South Africa**

Phone +27 10 060 0550  
E-Mail info@sickautomation.co.za

**South Korea**

Phone +82 2 786 6321/4  
E-Mail infokorea@sick.com

**Spain**

Phone +34 93 480 31 00  
E-Mail info@sick.es

**Sweden**

Phone +46 10 110 10 00  
E-Mail info@sick.se

**Switzerland**

Phone +41 41 619 29 39  
E-Mail contact@sick.ch

**Taiwan**

Phone +886-2-2375-6288  
E-Mail sales@sick.com.tw

**Thailand**

Phone +66 2 645 0009  
E-Mail marcom.th@sick.com

**Turkey**

Phone +90 (216) 528 50 00  
E-Mail info@sick.com.tr

**United Arab Emirates**

Phone +971 (0) 4 88 65 878  
E-Mail contact@sick.ae

**United Kingdom**

Phone +44 (0)17278 31121  
E-Mail info@sick.co.uk

**USA**

Phone +1 800.325.7425  
E-Mail info@sick.com

**Vietnam**

Phone +65 6744 3732  
E-Mail sales.gsg@sick.com

Detailed addresses and further locations at [www.sick.com](http://www.sick.com)

