



FORK SENSORS

SIMPLICITY, FLEXIBILITY, AND PRECISION –
COMBINED IN A SINGLE FORK SENSOR

Registration sensors

SICK
Sensor Intelligence.

SIMPLICITY, FLEXIBILITY, AND PRECISION – COMBINED IN A SINGLE FORK SENSOR

Hitting the mark without the need for extensive preparation is the very definition of precision. What makes fork sensors from SICK really stand out, however, is more than just their accuracy – it's also their outstanding equipment configuration. The sender and receiver are integrated into a single housing, saving time spent on alignment.

Sensors that operate using a through-beam design always require a certain amount of adjustment and alignment. That is, unless the sender and receiver are both integrated into a rugged housing made of plastic or aluminum – as is the case with SICK fork sensors. With their precise, focused beam of light, the infrared, red light, laser, and ultrasonic variants that are available offer a key advantage when it comes to reliable detection of labels, double sheets, and various types of objects. These sensors are even able to detect very slight differences in light attenuation. A wide range of fork sizes, straightforward mounting, and exceptionally high ambient light immunity are additional advantages that the fork sensors offer.





Advantages at a glance

- Quick and easy mounting as the sender and receiver are integrated into one housing
- Numerous fork sizes and detection principles (infrared LED, red light LED, laser, and ultrasonic) to accommodate all kinds of applications
- Reliable performance at high speeds thanks to high switching frequency
- High ambient light immunity provides a high level of operational safety
- Rugged aluminum housing for use in harsh industrial environments

TWO OPERATING CONCEPTS FOR INCREASED FLEXIBILITY

Various procedures are available for carrying out teach-in configuration of fork sensors. In addition to static 2-point teach-in, a dynamic teach-in procedure is available for selection. This flexibility is also reflected in the operating concept used when performing the teach-in procedure.

In addition to the proven variants that enable settings to be made using plus/minus buttons, the teach-in button variants provide the option of performing the teach-in procedure using just one button. This means that SICK offers its customers the advantage of an intuitive sensor that is equipped with one and the same operating concept across all product variants.

Thanks to an IO-Link interface installed as standard and optional smart automation functions, SICK fork sensors are equipped for the long term, ready to face the requirements of the future – and combine standard sensors with pioneering sensor intelligence in order to do so.

The two operating concepts at a glance

Operating concept with plus/minus buttons

- Static and dynamic teach-in procedure available
- Option of individual switching threshold readjustment using plus/minus buttons
- Option of changing between light/dark switching
- Pushbutton lock can be activated and deactivated



Operating concept with teach-in button

- Standardized design
- Intuitive operating concept
- Static and dynamic teach-in procedure available
- Option of single-stage fine adjustment using teach-in button
- Option of changing between light/dark switching
- Pushbutton lock can be activated and deactivated



 **IO-Link***

* With the exception of UFN.

TWO FUNCTIONAL PRINCIPLES ACHIEVE THE DESIRED RESULT

There are two different principles of operation used in SICK fork sensors.



Optical fork sensors

Optical fork sensors detect objects via the interruption of the light beam. Even slight differences in light attenuation are detected reliably in this way.

Fields of application

- Label detection
- Counting and positioning objects
- Process control

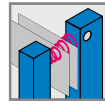

Ultrasonic fork sensors

In this case, it is the material properties (such as thickness and adhesion) that are evaluated and reliably detected, rather than the transparency. Thicker materials absorb the sensor's ultrasonic properties more strongly than thin materials. Transparent materials are detected regardless of their printed design or color.

Fields of application

- Label detection
- Double sheet detection
- Adhesive surface detection

Switching function

Switching output Q = dark switching

The switching output is active when the path of the beam is interrupted; that is, an object is located in the path of the beam.

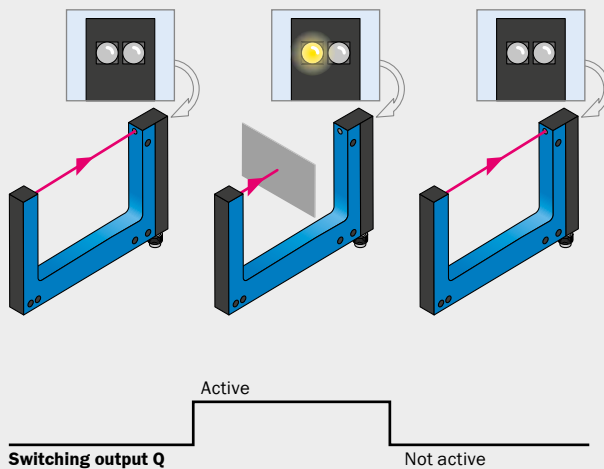

Switching output \bar{Q} = light switching

The switching output is active when there is no object in the path of the beam.

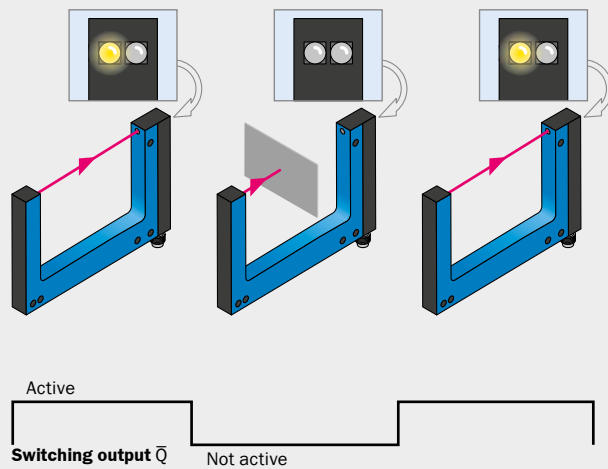

In label recognition, this means:
The switching output is active when the label is present.

In label recognition, this means:
The switching output is active when the label is not present.

LABEL OR DOUBLE SHEET DETECTION

Transparent, shiny, and metallic labels; white, opaque, and colored substrate; thin foils, foil on foil, paper on paper – modern labeling machines are faced with a variety of materials and surface properties. SICK fork sensors always offer the right solution. Optical fork sensors are able to detect opaque labels, for example, reliably. Ultrasonic fork sensors detect even transparent materials reliably, regardless of their printing design.

WFS – Agile and flexible, enabling ideal mounting in label detection applications



IO-Link

- Infrared transmission source
- Optimized housing thanks to slim fork shape
- Simple and precise setting of the switching threshold via IO-Link, teach-in button, or plus/minus buttons
- Smart sensor with integrated IO-Link interface



UFN – The clear choice for detecting transparent labels



- Ultrasonic transmission source
- Detection of transparent, opaque, or printed labels
- Simple and precise setting of the switching threshold via teach-in button or plus/minus buttons
- Not affected by metalized colors
- Response time of 250 μ s



OBJECT DETECTION

In order to control various processes logistically, it is necessary to reliably detect certain objects on the conveyor belts. As soon as an object passes the fork sensor, it is detected. Thanks to a whole host of different transmission sources and sizes, the right fork sensor can always be found to suit every requirement. The design accommodates the sender and receiver in a single housing. Commissioning is as easy as the mounting process is quick, since no complex, time-consuming alignment is needed.

WFN – The all-round solution for high-speed applications



 IO-Link

- Infrared transmission source
- Simple and precise setting of the switching threshold via IO-Link, teach-in button, or plus/minus buttons
- Fast response time (max. 100 µs)
- Smart sensor with integrated IO-Link interface

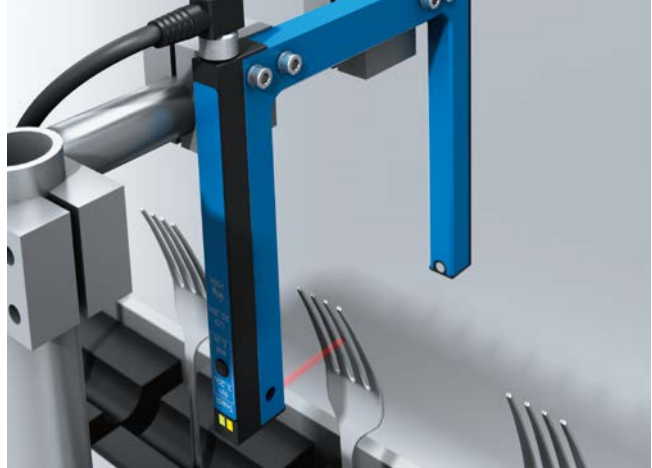

WFL – For the smallest of parts and precise positioning



 IO-Link

- Very precise laser (Class 1)
- Simple and precise setting of the switching threshold via IO-Link, teach-in button, or plus/minus buttons
- Minimum detectable object size of just 0.05 mm
- Smart sensor with integrated IO-Link interface

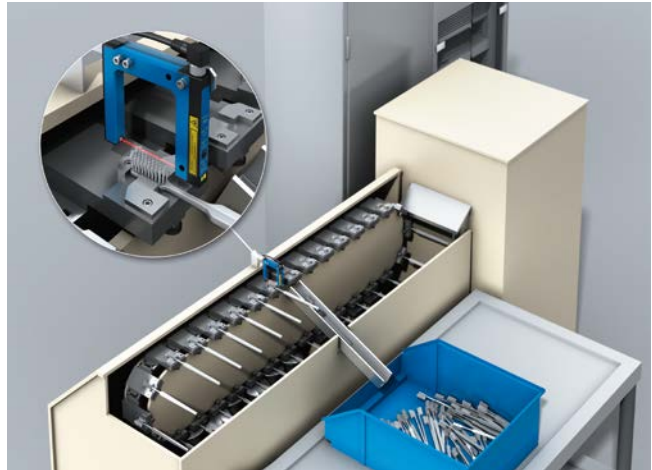

WFM – connect and go



- Clearly visible red emitted light
- No setup required, immediately operational
- Receive indicator, visible from any direction
- Rugged aluminum housing with IP 67 enclosure rating



OPTIMIZED AUTOMATION FOR MACHINES AND PLANTS

SICK sensors with IO-Link functions that can be integrated into an automation system offer a whole host of useful functions, from configuration and operation all the way through to monitoring.

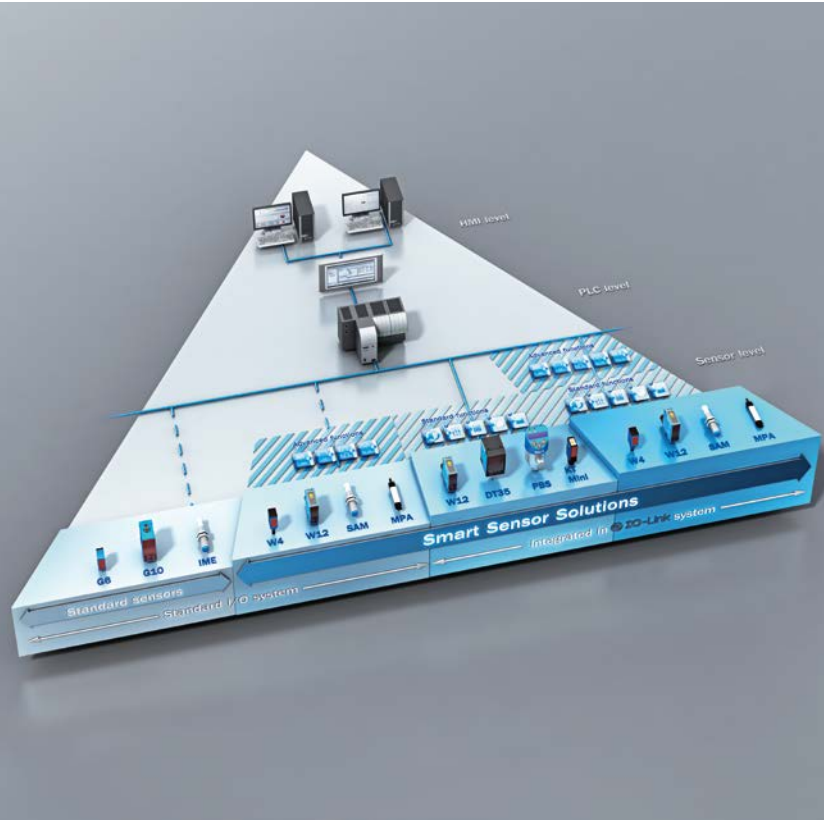

Condition monitoring/diagnostics

Implementing diagnostic and self-test options enables features such as contamination evaluation for sensors. Thanks to the monitoring capabilities of the sensors, preventive maintenance can be carried out using a precise maintenance plan. This ability to predict machine status even extends across area boundaries. The advantages of this are reduced maintenance and repair times, minimum risk of failure, as well as accurate fault localization and diagnostics.



E-parts list/E-inventory

IO-Link enables electronic documentation to be created for all sensors in the as-delivered state of the machine or plant, both quickly and automatically. The advantages of this are increased transparency in the electronic documentation for installed sensors, cables, and male connectors. This prevents time-consuming troubleshooting resulting from different documentation versions. Additionally, the machine or plant's as-delivered state can be documented easily and accurately in this way.



Sensor visualization

Sensor data such as the device ID, serial number, teach-in values, hysteresis, and switching behavior can be displayed and modified using visualization software via the SiLink Box on the PC. All parameters can be optimized and transferred to multiple sensors.

The advantages of this are:

- Comprehensive diagnostics options
- Availability values can be checked and parameters can be optimized
- Simplified selection of function range and performance capability
- Quick and safe sensor pre-configuration
- Easy identification of optimized application parameters
- Simple commissioning



Flexible sensor adjustment

The automation system provides the IO-Link sensor with optimum application-specific parameters for the manufacturing process or the product being manufactured, such as the sensing distance, hysteresis, or threshold. The advantages of this are reduced machine downtimes and changeover times when switching products, more machine flexibility, and the prevention of incorrect settings.



Easy device replacement

Sensors with IO-Link can be replaced quickly and easily as they are able to adopt the set function parameters without any alterations. The parameters are stored in the IO-Link master or in the control system. The advantages of this are minimal downtimes, guaranteed machine availability, as well as recorded and documented replacement processes.

By using state-of-the-art sensor technology and integrating it into an automation network, it is possible to take advantage of innovative functions that have a direct impact on a plant or machine's productivity.

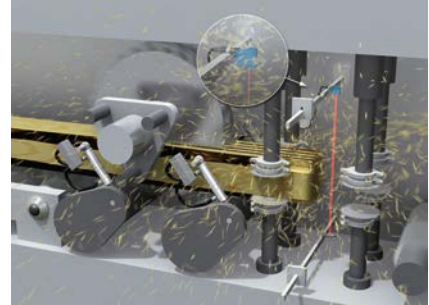

High-speed counters

Some plants and machines have to know how fast conveying equipment is moving in order to carry out control tasks, or they need to ensure that the speed of a roller stays within defined limits. Using the counting function in the -A71 fork sensor variants, it is possible to implement these and other automation tasks with maximum efficiency.



Time measurement

In some plants and machines, it is necessary to check that an object being transported to another destination is the right shape or in the right position on the conveying equipment. The -A70 fork sensor variant measures the time window directly and with high precision, and provides the measurement result in the format required by the control system so that this information can undergo further processing.



Remote debouncing



For some plants and machines, maintaining productivity levels requires sensors to know which detection signals are disturbances, and to suppress those disturbances using additional detection information. This prevents the control system from being burdened with information that will disrupt the process. The -A70 and -A71 fork sensor variants are equipped with this function.

Part number	Type	High-speed counters	Time measurement	Remote debouncing	Page
6058645	WFL50-40B41CA70		■	■	→ 44
6058646	WFL50-40B41CA71	■		■	→ 44
6058615	WF2-40B41CA70		■	■	→ 31
6058616	WF2-40B41CA71	■		■	→ 31
6058617	WF30-40B41CA70		■	■	→ 32
6058619	WF30-40B41CA71	■		■	→ 32
6059834	WF50-40B41CA71	■		■	→ 32
6059993	WF50-60B41CA70		■	■	→ 32
6059994	WF50-60B41CA71	■		■	→ 32
6058650	WFS3-40B41CA70		■	■	→ 23
6058651	WFS3-40B41CA71	■		■	→ 23

Other fork variants including automation functions are available on request.

You will find detailed information on Smart Sensor Solutions powered by IO-Link in the special information with the same name (part number 8011727).

PRODUCT FAMILY OVERVIEW

	 <p style="text-align: center;">UFnext</p>	 <p style="text-align: center;">WFS</p>
	The clear choice for detecting transparent labels	Precise detection for optimum label detection

Technical data overview			
Functional principle	Ultrasonic detection principle		Optical detection principle
Fork width	3 mm		3 mm
Fork depth	69 mm		42 mm
MDO	Gap between labels: 2 mm Size of labels: 2 mm		Gap between labels: 2 mm Size of labels: 2 mm
Light source	-		LED, Infrared light
Switching frequency	1.5 kHz		10 kHz / 15 kHz
Response time	250 µs		46 µs / 50 µs
Output function	Light/darkswitching, selectable via button		Light/darkswitching, selectable via button
Connection type	Connector M8, 4-pin		Connector M8, 4-pin Cable, 4-wire 2 m
IO-Link	-		✓ / -
IO-Link Funktionen	-		Standard Advanced
Advanced Funktionen	-		Time measurement + decentralized debouncing / High speed counter + decentralized debouncing (depending on type)

At a glance		
	<ul style="list-style-type: none"> • Detection of transparent, opaque or printed labels • Unaffected by metallic foils and labels • Fast response time of 250 µs • Simple and accurate adjustment via teach-in button, or plus/minus buttons • Rugged, IP 65 aluminum housing 	<ul style="list-style-type: none"> • Housing with slim forked shape • Simple and precise setting of the switching threshold via IO-Link, teach-in button, or plus/minus buttons • Light/dark switching function • Fast response time: 50 µs • PNP or NPN switching output • Plastic housing with IP 65 enclosure rating • Smart sensor with integrated IO-Link interface

Detailed information	→ 12	→ 20
-----------------------------	------	------



WFnext

The specialist for high-speed applications



WFL

The perfect sensor for the detection of very small parts and precise positioning



WFM

Plug-and-play fork sensors – connect and get started

Optical detection principle	Optical detection principle	Optical detection principle
2 mm ... 120 mm	2 mm ... 120 mm	30 mm ... 180 mm
42 mm ... 95 mm	42 mm ... 95 mm	42 mm ... 124 mm
0.2 mm	0.05 mm	0.8 mm 1 mm
LED, Infrared light	Laser, visible red light	LED, visible red light
10 kHz / 15 kHz	10 kHz / 11 kHz	4 kHz
46 µs / 100 µs	60 µs / 100 µs	125 µs
Light/darkswitching, selectable via button	Light/darkswitching, selectable via button	Dark switching / Light switching
Connector M8, 4-pin	Connector M8, 4-pin	Connector M8, 3-pin Cable, 3-wire 2 m
✓ / -	✓ / -	-
Standard Advanced	Standard Advanced	-
Time measurement + decentralized debouncing / High speed counter + decentralized debouncing (depending on type)	Time measurement + decentralized debouncing / High speed counter + decentralized debouncing (depending on type)	-

- Infrared light source
- Simple and precise setting of the switching threshold via IO-Link, teach-in button, or plus/minus buttons
- Fast response time: 100 µs
- PNP and NPN switching output
- Light/dark switching function
- Stable aluminum housing with IP 65 enclosure rating
- Smart sensor with integrated IO-Link interface

→ 28

- Very precise Class 1 laser
- Simple and precise setting of the switching threshold via IO-Link, teach-in button, or plus/minus buttons
- Fast response time: 100 µs
- PNP and NPN switching output
- Light/dark switching function
- Stable aluminum housing with IP 65 enclosure rating
- Smart sensor with integrated IO-Link interface

→ 40

- Clearly visible red emitted light
- No setup required: The sensor is ready for operation immediately
- Receive indicator, visible all-round
- 5 fork sizes with a maximum depth of 120 mm and a maximum width of 180 mm
- Stable aluminum housing with IP 67 enclosure rating

→ 52

THE CLEAR CHOICE FOR DETECTING TRANSPARENT LABELS



Product description

The UF ultrasonic sensors reliably detects labels and materials, regardless of printed design, transparency or surface characteristics. Unlike optical sensors, the UF3 relies on damping – a process where the thickness of a material determines the degree to which the sensor absorbs sound waves. A high level of positioning accuracy and stable response times make the fork sensor suitable for nearly any environment. Due

to its small, compact metal housing, the UF can be used in harsh conditions and where space is limited. As a result, the UF3 can distinguish between labels located just 2 mm apart from one another on an adhesive tape. Applications include detecting transparent labels on transparent substrates, detecting labels with different printed designs or differentiating between single- and two-ply materials.

At a glance

- Detection of transparent, opaque or printed labels
- Unaffected by metallic foils and labels
- Fast response time of 250 µs
- Simple and accurate adjustment via teach-in button, or plus/minus buttons
- Rugged, IP 65 aluminum housing

Your benefits

- Great flexibility: UF identifies labels reliably - regardless of whether they are transparent, opaque or printed
- Fast response times enable precise detection – even at high web speeds
- Teach-in function enables quick and easy commissioning
- The aluminum housing meets all requirements for use in harsh industrial conditions
- High process reliability: Ultrasonic technology prevents false detection, which may be caused by ambient light or shiny surfaces



Additional information

Detailed technical data 13

Ordering information 15

Dimensional drawings16

Adjustments17

Connection diagram.....17

Setting the switching threshold ... 18

→ www.sick.com/UFnext

For more information, simply enter the link or scan the QR code and get direct access to technical data, CAD design models, operating instructions, software, application examples, and much more.



Detailed technical data

Features

	UFnext - Teach-in button	UFnext - Plus/minus buttons
Dimensions (W x H x D)	18 mm x 47.5 mm x 92.5 mm	
Functional principle	Ultrasonic detection principle	
Housing design (light emission)	Fork shaped	
Fork width	3 mm	
Fork depth	69 mm	
Minimum detectable object (MDO)	Gap between labels: 2 mm Size of labels: 2 mm	
Label detection	✓	
Adjustment	Teach-in button Cable (depending on type)	Plus/minus buttons Cable (depending on type)
Teach-in mode	1-point-teach-in 2-point teach-in Dynamic Teach-in	2-point teach-in Dynamic Teach-in
Output function	Light/darkswitching, selectable via button	

Interfaces

	UFnext - Teach-in button	UFnext - Plus/minus buttons
IO-Link Funktionen	-	
Advanced Funktionen	-	
Fieldbus, industrial network	-	
Type of fieldbus integration	-	

Mechanics/electronics

	UFnext - Teach-in button	UFnext - Plus/minus buttons
Supply voltage ¹⁾	10 V DC ... 30 V DC	
Ripple ²⁾	< 10 %	
Power consumption ³⁾	40 mA	
Switching frequency ⁴⁾	1.5 kHz	
Response time ⁵⁾	250 µs	
Output type	PNP NPN (depending on type)	
Switching output (voltage)	PNP: HIGH = $V_S - \leq 2 \text{ V}$ / LOW approx. 0 V NPN: HIGH = approx. V_S / LOW $\leq 2 \text{ V}$ (depending on type)	
Switching output	Light/dark switching	
Output current I_{max} ⁶⁾	100 mA	
Input, teach-in (ET)	Teach: $U > 7 \text{ V} \dots < U_V$ Run: $U < 2 \text{ V}$	
Initialization time	100 ms	
Connection type	Connector M8, 4-pin	
Protection class ⁷⁾	III	
Circuit protection	Output Q short-circuit protected Interference pulse suppression	
Enclosure rating	IP 65	

Weight	95 g
Housing material	Aluminum

- ¹⁾ Limit values, reverse-polarity protected, operation in short-circuit protected network: max. 8 A.
- ²⁾ May not exceed or fall below U_v tolerances.
- ³⁾ Without load.
- ⁴⁾ With light/dark ratio 1:1, typical, depending on material and speed.
- ⁵⁾ Signal transit time with resistive load.
- ⁶⁾ Output current minimal 0.03 mA.
- ⁷⁾ Reference voltage DC 50 V.

Ambient data

	UFnext - Teach-in button	UFnext - Plus/minus buttons
Ambient operating temperature ¹⁾	+5 °C ... +55 °C	
Ambient storage temperature	-20 °C ... +70 °C	
Shock load	According to EN 60068-2-27	
EMC ²⁾	EN 60947-5-2	

- ¹⁾ Do not bend below 0 °C.
- ²⁾ The UFN complies with the Radio Safety Requirements (EMC) for the industrial sector (Radio Safety Class A). It may cause radio interference if used in residential areas.

Ordering information

Other models → www.sick.com/UFnext

UFnext, Teach-in button

- **IO-Link:** –
- **Fork width:** 3 mm
- **Fork depth:** 69 mm

Adjustment	Teach-in Verfahren	Output type	Connection diagram	Type	Part no.
Teach-in button (Teach-in, sensitivity, light/dark switching)	1-point-teach-in 2-point teach-in Dynamic Teach-in	PNP	Cd-092	UFN3-70P417	6058743
Cable (dynamic Teach-in)		NPN	Cd-092	UFN3-70N417	6058744
Teach-in button (Teach-in, sensitivity, light/dark switching)		PNP, NPN	Cd-086	UFN3-70B417	6058742

UFnext, Plus/minus buttons

- **IO-Link:** –
- **Fork width:** 3 mm
- **Fork depth:** 69 mm

Adjustment	Teach-in Verfahren	Output type	Connection diagram	Type	Part no.
Plus/minus buttons (Teach-in, sensitivity, light/dark switching)	2-point teach-in Dynamic Teach-in	PNP	Cd-092	UFN3-70P415	6049679
Cable (dynamic Teach-in)		NPN	Cd-092	UFN3-70N415	6049680
Plus/minus buttons (Teach-in, sensitivity, light/dark switching)		PNP, NPN	Cd-086	UFN3-70B413	6049678

Dimensional drawings (Dimensions in mm (inch))

UFnext - Plus/minus buttons

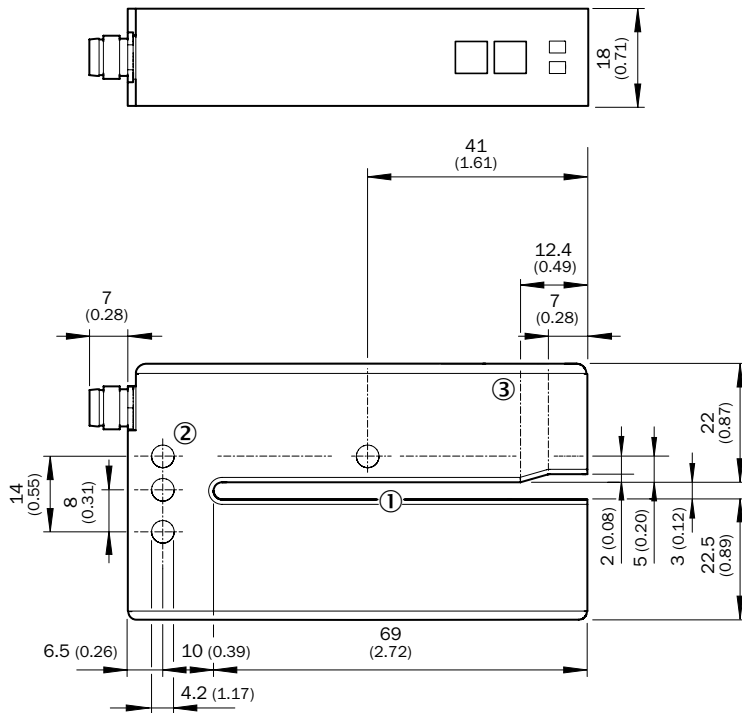

- ① Fork opening: fork width 3 mm, forks depth 69 mm
- ② Mounting hole, \varnothing 4.2 mm
- ③ Detection axis

UFnext - Teach-in button

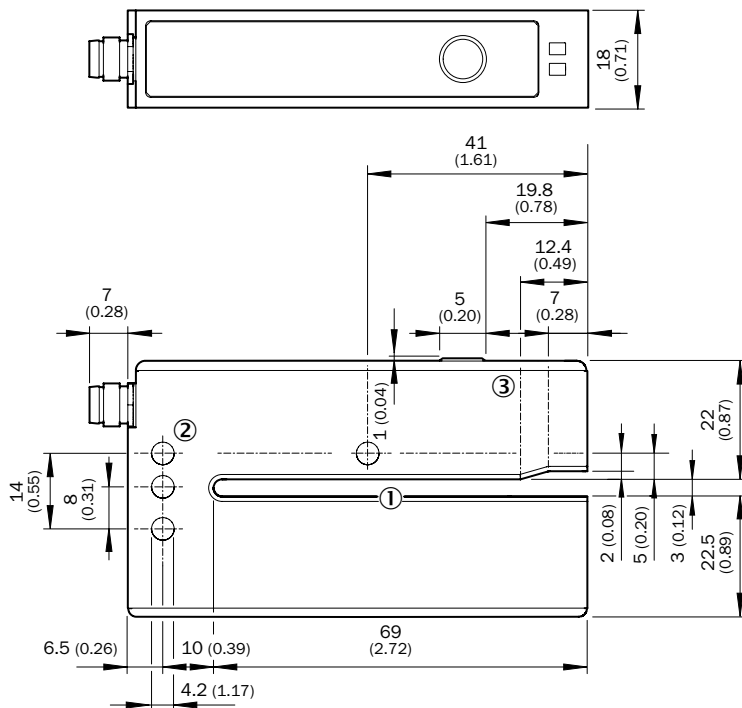

All dimensions in mm (inch)

- ① Fork opening: fork width 3 mm, forks depth 69 mm
- ② Mounting hole, \varnothing 4.2 mm
- ③ Detection axis

Adjustments

UFnext, Plus/minus buttons

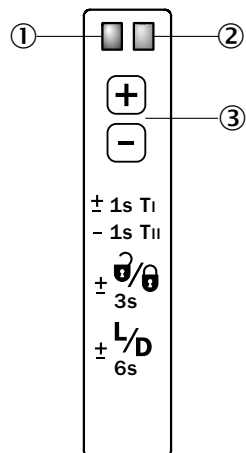

- ① Function signal indicator (yellow), switching output
- ② Function indicator (red)
- ③ Plus/minus buttons and function button

UFnext, Teach-in button

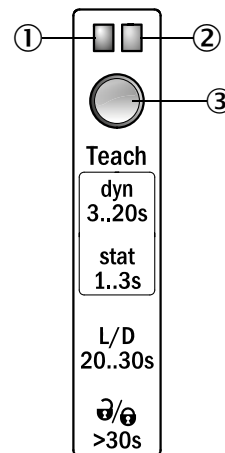

- ① Function signal indicator (yellow), switching output
- ② Function signal indicator (green)
- ③ Teach-in button and function button

Connection diagram

Cd-092

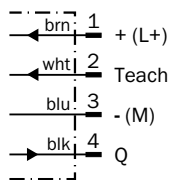

Cd-086

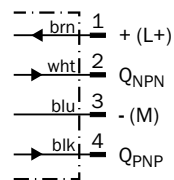

Setting the switching threshold

Teach-in dynamic via plus/minus buttons

- 1. Position label or substrate in the active area of the fork sensor**
- 2. Move multiple labels through the fork sensor**

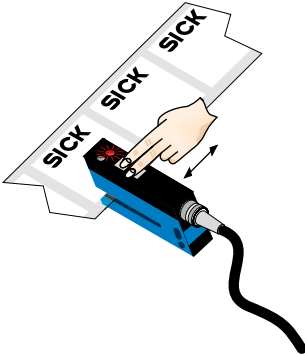

Press both the “+” and “-” buttons together, hold > 1 s and then release the teach-in buttons. The red LED flashes.

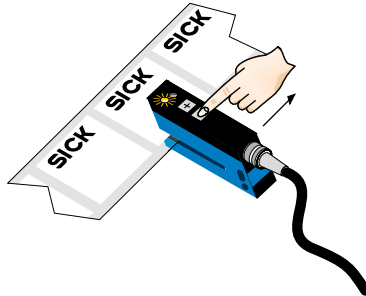

Press “-” button, teach-in process is finished.

Notes

Switching threshold adaptation:

Only, the first teach-in procedure after switching on is permanently stored. Teach-in can be repeated cyclically. Switching output also during teach-in active.

- + Once teach-in process is complete, the switching threshold can be adjusted at any time using the “+” or “-” button. To make minor adjustments, press the “+” or “-” button once. To configure settings quickly, keep the “+” or “-” button pressed for longer.

- ± Press both the “+” and “-” buttons together (3 seconds) to lock the device and prevent unintentional actuation.

- ± Press both the “+” and “-” buttons together (6 seconds) to define the switching function (light/dark switching). Standard setting: Q = light switching.

Teach-in (static): Setting the switching threshold without movements of label, cf. operating instruction.

Teach-in dynamic via Teach-in button

1. Start teach-in: Position carrier or label between the fork

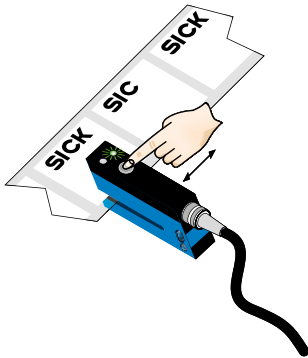

Press the teach-in button for 3 - 20 s. With the pushbutton pressed down, move several label with carrier material (label) through the sensor. The yellow LED flashes at 3 Hz during the teach-in procedure. Recommendation: Move at least 3 label + carrier through the sensor.

2. End teach-in:

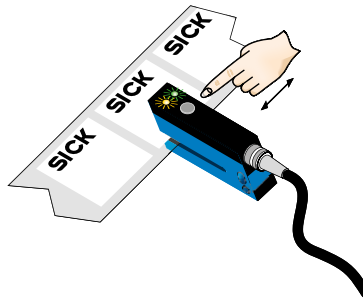

Release the teach-in button for < 20 s. If teach-in is successful, the function indicator (yellow LED) directly indicates the output state of the sensor. The switching threshold is now optimally set between carrier and label. The best possible operational safety is provided.

Note

Fine adjustment

In order to obtain a higher operating reserve, a fine adjustment can be carried out after successful teach-in. For this purpose, the switching threshold is set close to the taught-in object. The teach-in button must be pressed and released within 10 s of successful teach-in. Successful setting is signaled by flashing twice at 1 Hz.

Light/dark switching

- You can change between light switching and dark switching by pressing the teach-in button for 20 - 30 s.

Pushbutton lock

- The device can be locked against unintended operation by pressing the teach-in button for > 30 s. The device can be unlocked by pressing the teach-in button again for > 30 s.

PRECISE DETECTION FOR OPTIMUM LABEL DETECTION



Product description

The slim, forked shape of the WFS has been specially developed for the requirements of the labeling process. The design allows the sensor to be mounted directly on the edge of a label dispenser. Difficulty in detecting the label gap is finally eliminated – the sensor’s switch-

ing threshold can be taught-in while the label strip is running. This sophisticated operating concept means the sensor can be adjusted to different labels quickly, easily, and reliably. The fast response time guarantees exceptional repeat accuracy.

At a glance

- Housing with slim forked shape
- Simple and precise setting of the switching threshold via IO-Link, teach-in button, or plus/minus buttons
- Light/dark switching function
- Fast response time: 50 µs
- PNP or NPN switching output
- Plastic housing with IP 65 enclosure rating
- Smart sensor with integrated IO-Link interface

Your benefits

- Flexible and simple mounting directly on the edge of a label dispenser ensures a high level of accuracy in the process
- Small housing allows simple installation even where space is limited
- User-friendly adjustment allows easy and quick commissioning
- Fast response times enable precise detection – even at very high track speeds
- Thanks to IO-Link or external teach-in, the switching threshold can be adapted while the process is running, increasing process reliability
- Easy to access data from the PLC via IO-Link



Additional information

Detailed technical data	21
Ordering information	23
Dimensional drawings	24
Adjustments	25
Connection diagram	25
Setting the switching threshold . . .	26

→ www.sick.com/WFS

For more information, simply enter the link or scan the QR code and get direct access to technical data, CAD design models, operating instructions, software, application examples, and much more.



Detailed technical data

Features

	WFS - Teach-in button	WFS - Plus/minus buttons
Dimensions (W x H x D)	10 mm x 25 mm x 64.3 mm	
Functional principle	Optical detection principle	
Housing design (light emission)	Fork shaped	
Fork width	3 mm	
Fork depth	42 mm	
Minimum detectable object (MDO)	Gap between labels: 2 mm Size of labels: 2 mm ¹⁾	
Label detection	✓	
Light source	LED, Infrared light	
Adjustment	Teach-in button Cable	Plus/minus buttons Cable
Teach-in mode	1-point-teach-in 2-point teach-in Dynamic Teach-in	Dynamic Teach-in
Output function	Light/darkswitching, selectable via button	

¹⁾ Depends on the label thickness.

Interfaces

	WFS - Teach-in button	WFS - Plus/minus buttons
IO-Link Funktionen	Standard Advanced (depending on type)	-
Advanced Funktionen	Time measurement + decentralized debouncing / High speed counter + decentralized debouncing (depending on type)	-
Fieldbus, industrial network	IO-Link	-
Type of fieldbus integration	Integrated in the device	-

Mechanics/electronics

	WFS - Teach-in button	WFS - Plus/minus buttons
Supply voltage ¹⁾	10 V DC ... 30 V DC	
Ripple ²⁾	< 10 %	
Power consumption ³⁾	20 mA	
Switching frequency	15 kHz ⁴⁾	10 kHz ⁵⁾
Response time ⁶⁾	46 µs	50 µs
Stability of response time	± 20 µs	
Jitter	17 µs	40 µs
Output type	PUSH/PULL	PNP / NPN (depending on type)
Switching output (voltage)	Push/Pull: High = $V_S - < 2 V$ / Low: $\leq 2 V$	PNP: HIGH = $V_S - \leq 2 V$ / LOW approx. 0 V / NPN: HIGH = approx. V_S / LOW $\leq 2 V$ (depending on type)
Switching output	Light/dark switching	
Output current $I_{max.}$	100 mA	

	WFS - Teach-in button	WFS - Plus/minus buttons
Input, teach-in (ET)	Teach: $U > 5\text{ V} \dots < U_V$ Run: $U < 4\text{ V}$	PNP Teach: $U > 5\text{ V} \dots < U_V$ Run: $U < 4\text{ V}$ NPN Teach: $U < (U_V - 6\text{ V})$ Run: $U > (U_V - 5\text{ V})$
Initialization time	40 ms	20 ms
Connection type	Connector M8, 4-pin	Cable, 4-wire, 2 m Connector M8, 4-pin (depending on type)
Ambient light immunity	$\leq 10,000\text{ lx}$	
Protection class	III	
Circuit protection	U_V connections, reverse polarity protected Output Q short-circuit protected Interference pulse suppression	
Enclosure rating	IP 65	
Weight	Approx. 36 g	
Housing material	PA (glass-fiber reinforced)	

¹⁾ Limit values, reverse-polarity protected, operation in short-circuit protected network: max. 8 A.

²⁾ May not exceed or fall below U_V tolerances.

³⁾ Without load.

⁴⁾ With light/dark ratio 1:1, typical, during teach-in 6 kHz.

⁵⁾ With light/dark ratio 1:1.

⁶⁾ Signal transit time with resistive load.

Ambient data

	WFS - Teach-in button	WFS - Plus/minus buttons
Ambient operating temperature ¹⁾	-20 °C ... +60 °C	
Ambient storage temperature	-30 °C ... +80 °C	
Shock load	According to EN 60068-2-27	

¹⁾ Do not bend below 0 °C.

Ordering information

Other models → www.sick.com/WFS

WFS, Teach-in button

- **IO-Link:** ✓
- **Output type:** PUSH/PULL
- **Connection type:** Connector M8, 4-pin
- **Connection diagram:** cd-273
- **Adjustment:** Teach-in button (Teach-in, sensitivity, light/dark switching), cable (dynamic Teach-in)

Fork width	Teach-in mode	IO-Link functions	Advanced functions	Fork depth	Type	Part no.
3 mm	1-point-teach-in 2-point teach-in Dynamic Teach-in	Standard	—	42 mm	WFS3-40B41CA00	6058649
		Advanced	Time measurement + decentralized debouncing		WFS3-40B41CA70	6058650
			High speed counter + decentralized debouncing		WFS3-40B41CA71	6058651

WFS, Plus/minus buttons

- **IO-Link:** –
- **IO-Link functions:** –
- **Advanced functions:** –
- **Connection diagram:** cd-092
- **Adjustment:** Plus/minus buttons (Teach-in, sensitivity, light/dark switching), cable (dynamic Teach-in)

Fork width	Fork depth	Teach-in mode	Output type	Connection type	Type	Part no.
3 mm	42 mm	Dynamic Teach-in	PNP	Cable, 4-wire	WFS3-40P115	6055433
				Connector M8, 4-pin	WFS3-40P415	6043919
			NPN	Cable, 4-wire	WFS3-40N115	6055434
				Connector M8, 4-pin	WFS3-40N415	6043920

Dimensional drawings (Dimensions in mm (inch))

WFS - Plus/minus buttons

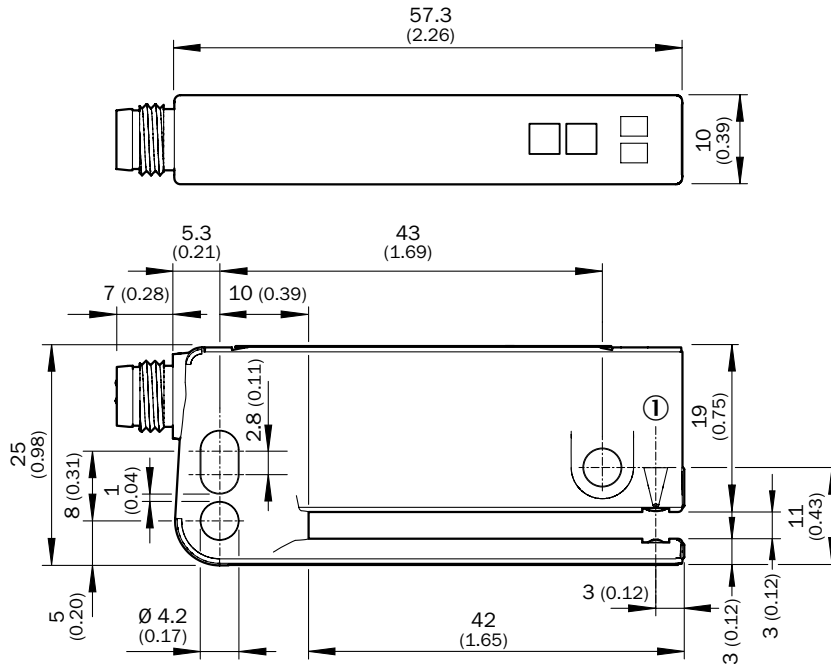

① Optical axis

WFS - Teach-in button

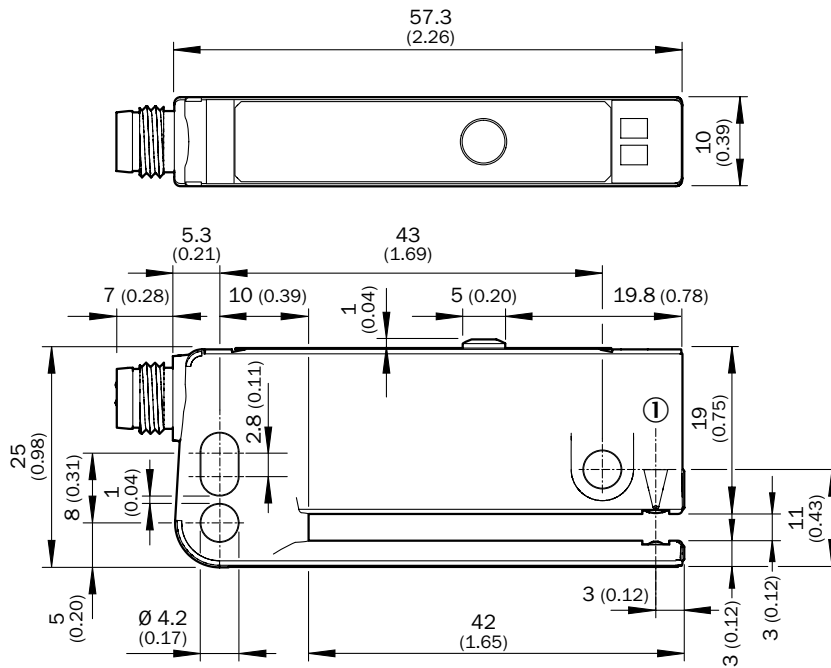

① Optical axis

Adjustments

WFS, Plus/minus buttons

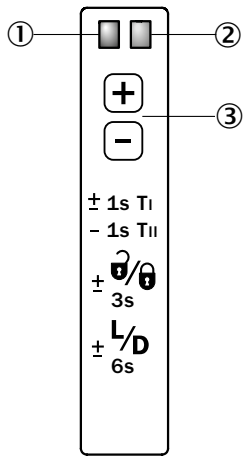

- ① Function signal indicator (yellow), switching output
- ② Function indicator (red)
- ③ Plus/minus buttons and function button

WFS, Teach-in button

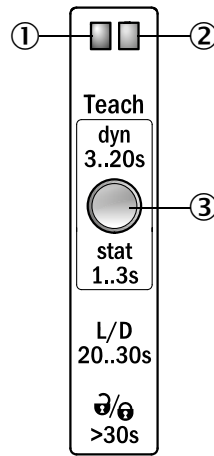

- ① Function signal indicator (yellow), switching output
- ② Function signal indicator (green)
- ③ Teach-in button and function button

Connection diagram

Cd-273

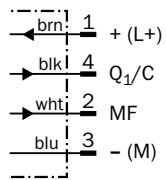

Cd-092

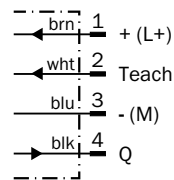

Setting the switching threshold

Teach-in via plus/minus buttons

1. Position label or substrate in the active area of the fork sensor
2. Move multiple labels through the fork sensor

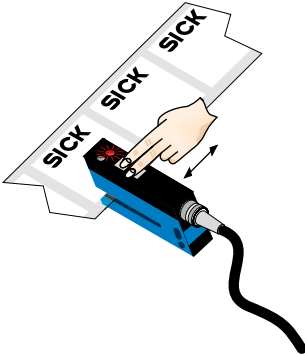

Press both the “+” and “-” buttons together, hold > 1 s and then release the teach-in buttons. The red LED flashes.

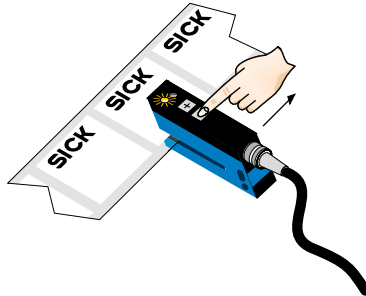

Press “-” button, teach-in process is finished.

Notes

Switching threshold adaptation:

Only, the first teach-in procedure after switching on is permanently stored. Teach-in can be repeated cyclically. Switching output also during teach-in active.

- + Once teach-in process is complete, the switching threshold can be adjusted at any time using the “+” or “-” button. To make minor adjustments, press the “+” or “-” button once. To configure settings quickly, keep the “+” or “-” button pressed for longer.

- ± Press both the “+” and “-” buttons together (3 seconds) to lock the device and prevent unintentional actuation.

- ± Press both the “+” and “-” buttons together (6 seconds) to define the switching function (light/dark switching). Standard setting: Q = light switching.

Teach-in (static): Setting the switching threshold without movements of label, cf. operating instruction.

Teach-in via Teach-in button

1. Start teach-in: Position carrier or label between the fork

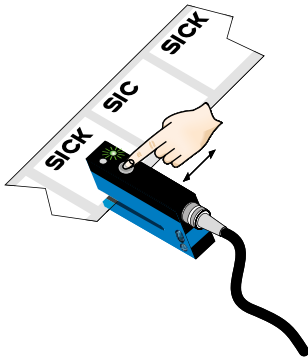

Press the teach-in button for 3 - 20 s. With the pushbutton pressed down, move several label with carrier material (label) through the sensor. The yellow LED flashes at 3 Hz during the teach-in procedure. Recommendation: Move at least 3 label + carrier through the sensor.

2. End teach-in:

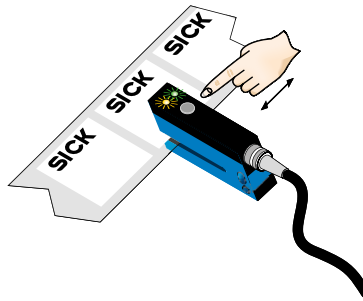

Release the teach-in button for < 20 s. If teach-in is successful, the function indicator (yellow LED) directly indicates the output state of the sensor. The switching threshold is now optimally set between carrier and label. The best possible operational safety is provided.

Note

Fine adjustment

In order to obtain a higher operating reserve, a fine adjustment can be carried out after successful teach-in. For this purpose, the switching threshold is set close to the taught-in object. The teach-in button must be pressed and released within 10 s of successful teach-in. Successful setting is signaled by flashing twice at 1 Hz.

Light/dark switching

- You can change between light switching and dark switching by pressing the teach-in button for 20 - 30 s.

Pushbutton lock

- The device can be locked against unintended operation by pressing the teach-in button for > 30 s. The device can be unlocked by pressing the teach-in button again for > 30 s.

THE SPECIALIST FOR HIGH-SPEED APPLICATIONS



Product description

WFnext fork sensors are at work in the detection of labels, marks, double sheets, holes, edges, and various objects. Thanks to the design principle that sees both the sender and receiver integrated in a single housing, no adjustment is necessary. This easy-to-use sensor line includes fork widths between 2 mm and 120 mm with fork depths of

40 mm, 60 mm, and 95 mm. Extremely fast response times and fine resolution means that WFnext fork sensors from SICK can even detect small and flat objects, as well as those traveling at high speeds. On multiple installations, WFnext sensors can be installed adjacent to one another with no cross talk.

At a glance

- Infrared light source
- Simple and precise setting of the switching threshold via IO-Link, teach-in button, or plus/minus buttons
- Fast response time: 100 µs
- PNP and NPN switching output
- Light/dark switching function
- Stable aluminum housing with IP 65 enclosure rating
- Smart sensor with integrated IO-Link interface

Your benefits

- Fast response time and fine resolution ensure reliable detection even at very high object speeds
- Infrared light source provides excellent ambient light immunity
- User-friendly setting via IO-Link, teach-in button, or plus/minus buttons
- A wide range of different fork sizes enables flexible installation
- Stable aluminum housing for use in harsh industrial environments
- Thanks to IO-Link or external teach-in, the switching threshold can be adapted while the process is running, increasing process reliability
- Easy to access data from the PLC via IO-Link



Additional information

Detailed technical data	29
Ordering information	31
Dimensional drawings	36
Adjustments	37
Connection diagram	37
Setting the switching threshold	37

→ www.sick.com/WFnext

For more information, simply enter the link or scan the QR code and get direct access to technical data, CAD design models, operating instructions, software, application examples, and much more.



Detailed technical data

Features

	WFnext - Teach-in button	WFnext - Plus/minus buttons
Functional principle	Optical detection principle	
Housing design (light emission)	Fork shaped	
Fork width	2 mm ... 120 mm (depending on type)	
Fork depth	42 mm ... 95 mm (depending on type)	
Minimum detectable object (MDO)	0.2 mm	
Label detection	✓	✓ / - (depending on type)
Light source	LED, Infrared light	
Adjustment	Teach-in button Cable	Plus/minus buttons
Teach-in mode	1-point-teach-in 2-point teach-in Dynamic Teach-in	2-point teach-in (depending on type)
Output function	Light/darkswitching, selectable via button	

Interfaces

	WFnext - Teach-in button	WFnext - Plus/minus buttons
IO-Link Funktionen	Standard Advanced (depending on type)	-
Advanced Funktionen	Time measurement + decentralized debouncing / High speed counter + decentralized debouncing (depending on type)	-
Fieldbus, industrial network	IO-Link	-
Type of fieldbus integration	Integrated in the device	-

Mechanics/electronics

	WFnext - Teach-in button	WFnext - Plus/minus buttons
Supply voltage ¹⁾	10 V DC ... 30 V DC	
Ripple ²⁾	< 10 %	
Power consumption	20 mA ³⁾	40 mA
Switching frequency ⁴⁾	15 kHz	10 kHz
Response time	46 µs ⁵⁾	100 µs
Stability of response time	± 20 µs	
Jitter	17 µs	40 µs
Output type	PUSH/PULL	PNP/NPN
Switching output (voltage)	Push/Pull: High = $V_S - < 2 V$ / Low: $\leq 2 V$	PNP: HIGH = $V_S - \leq 2 V$ / LOW approx. 0 V NPN: HIGH = approx. V_S / LOW $\leq 2 V$
Switching output	Light/dark switching	
Output current $I_{max.}$	100 mA	
Input, teach-in (ET)	Teach: $U > 5 V \dots < U_V$ Run: $U < 4 V$	-
Initialization time	40 ms	100 ms
Connection type	Connector M8, 4-pin	
Ambient light immunity	Sunlight: $\leq 10,000$ klx	

	WFnext - Teach-in button	WFnext - Plus/minus buttons
Protection class ⁶⁾	III	
Circuit protection	U _v connections, reverse polarity protected Output Q short-circuit protected Interference pulse suppression	
Enclosure rating	IP 65	
Weight ⁷⁾	Approx. 36 g ... 160 g	
Housing material	Aluminum	

¹⁾ Limit values, reverse-polarity protected, operation in short-circuit protected network: max. 8 A.

²⁾ May not exceed or fall below U_v tolerances.

³⁾ Without load.

⁴⁾ With light/dark ratio 1:1.

⁵⁾ Signal transit time with resistive load.

⁶⁾ Reference voltage DC 50 V.

⁷⁾ Depending on fork width.

Ambient data

	WFnext - Teach-in button	WFnext - Plus/minus buttons
Ambient operating temperature ¹⁾	-20 °C ... +60 °C	
Ambient storage temperature	-30 °C ... +80 °C	
Shock load	According to EN 60068-2-27	
UL File No.	NRKH.E191603	

¹⁾ Do not bend below 0 °C.

Ordering information

Other models → www.sick.com/WFnext

WF2, Teach-in button

- **IO-Link:** ✓
- **Output type:** PUSH/PULL
- **Connection diagram:** cd-273
- **Adjustment:** Teach-in button (Teach-in, sensitivity, light/dark switching), cable (dynamic Teach-in)

Fork width	Teach-in mode	IO-Link functions	Advanced functions	Fork depth	Type	Part no.
2 mm	1-point-teach-in 2-point teach-in Dynamic Teach-in	Standard	—	42 mm	WF2-40B41CA00	6058568
		Advanced	Time measurement + decentralized debouncing	42 mm	WF2-40B41CA70	6058615
			High speed counter + decentralized debouncing	42 mm	WF2-40B41CA71	6058616
		Standard	— ¹⁾	59 mm	WF2-60B41CA00	6058601
				95 mm	WF2-95B41CA00	6058608

¹⁾ On request also available with advanced funktions A70 or A71.

WF5, Teach-in button

- **IO-Link:** ✓
- **Output type:** PUSH/PULL
- **Connection diagram:** cd-273
- **Adjustment:** Teach-in button (Teach-in, sensitivity, light/dark switching), cable (dynamic Teach-in)

Fork width	Teach-in mode	IO-Link functions	Advanced functions ¹⁾	Fork depth	Type	Part no.
5 mm	1-point-teach-in 2-point teach-in Dynamic Teach-in	Standard	—	42 mm	WF5-40B41CA00	6058595
				59 mm	WF5-60B41CA00	6058602
				95 mm	WF5-95B41CA00	6058609

¹⁾ On request also available with advanced funktions A70 or A71.

WF15, Teach-in button

- **IO-Link:** ✓
- **Output type:** PUSH/PULL
- **Connection diagram:** cd-273
- **Adjustment:** Teach-in button (Teach-in, sensitivity, light/dark switching), cable (dynamic Teach-in)

Fork width	Teach-in mode	IO-Link functions	Advanced functions ¹⁾	Fork depth	Type	Part no.
15 mm	1-point-teach-in 2-point teach-in Dynamic Teach-in	Standard	—	42 mm	WF15-40B41CA00	6058596
				59 mm	WF15-60B41CA00	6058603
				95 mm	WF15-95B41CA00	6058610

¹⁾ On request also available with advanced funktions A70 or A71.

WF30, Teach-in button

- **IO-Link:** ✓
- **Output type:** PUSH/PULL
- **Connection diagram:** cd-273
- **Adjustment:** Teach-in button (Teach-in, sensitivity, light/dark switching), cable (dynamic Teach-in)

Fork width	Teach-in mode	IO-Link functions	Advanced functions	Fork depth	Type	Part no.
30 mm	1-point-teach-in 2-point teach-in Dynamic Teach-in	Standard	—	42 mm	WF30-40B41CA00	6058597
		Advanced	Time measurement + decentralized debouncing	42 mm	WF30-40B41CA70	6058617
			High speed counter + decentralized debouncing	42 mm	WF30-40B41CA71	6058619
		Standard	— ¹⁾	59 mm	WF30-60B41CA00	6058604
				95 mm	WF30-95B41CA00	6058611

¹⁾ On request also available with advanced functions A70 or A71.

WF50, Teach-in button

- **IO-Link:** ✓
- **Output type:** PUSH/PULL
- **Connection diagram:** cd-273
- **Adjustment:** Teach-in button (Teach-in, sensitivity, light/dark switching), cable (dynamic Teach-in)

Fork width	Teach-in mode	IO-Link functions	Advanced functions ¹⁾	Fork depth	Type	Part no.
50 mm	1-point-teach-in 2-point teach-in Dynamic Teach-in	Standard	—	42 mm	WF50-40B41CA00	6058598
		Advanced	High speed counter + decentralized debouncing	42 mm	WF50-40B41CA71	6059834
				59 mm	WF50-60B41CA00	6058605
		Standard	—	95 mm	WF50-95B41CA00	6058612

¹⁾ On request also available with advanced functions A70 or A71.

WF80, Teach-in button

- **IO-Link:** ✓
- **Output type:** PUSH/PULL
- **Connection diagram:** cd-273
- **Adjustment:** Teach-in button (Teach-in, sensitivity, light/dark switching), cable (dynamic Teach-in)

Fork width	Teach-in mode	IO-Link functions	Advanced functions ¹⁾	Fork depth	Type	Part no.
80 mm	1-point-teach-in 2-point teach-in Dynamic Teach-in	Standard	—	42 mm	WF80-40B41CA00	6058599
				59 mm	WF80-60B41CA00	6058606
				95 mm	WF80-95B41CA00	6058613

¹⁾ On request also available with advanced functions A70 or A71.

WF120, Teach-in button

- **IO-Link:** ✓
- **Output type:** PUSH/PULL
- **Connection diagram:** cd-273
- **Adjustment:** Teach-in button (Teach-in, sensitivity, light/dark switching), cable (dynamic Teach-in)

Fork width	Teach-in mode	IO-Link functions	Advanced functions ¹⁾	Fork depth	Type	Part no.
120 mm	1-point-teach-in 2-point teach-in Dynamic Teach-in	Standard	—	42 mm	WF120-40B41CA00	6058600
				59 mm	WF120-60B41CA00	6058607
				95 mm	WF120-95B41CA00	6058614

¹⁾ On request also available with advanced funktions A70 or A71.

WF2, Plus/minus buttons

- **IO-Link:** –
- **IO-Link functions:** –
- **Advanced functions:** –
- **Output type:** PNP/NPN
- **Connection diagram:** cd-086

Fork width	Adjustment	Teach-in mode	Fork depth	Type	Part no.
2 mm	Plus/minus buttons (Sensitivity, light/dark switching)	—	42 mm	WF2-40B410	6028428
			59 mm	WF2-60B410	6028436
			95 mm	WF2-95B410	6028443
	Plus/minus buttons (Teach-in, sensitivity, light/dark switching)	2-point teach-in	42 mm	WF2-40B416	6028450
			59 mm	WF2-60B416	6028457
			95 mm	WF2-95B416	6028464

WF5, Plus/minus buttons

- **IO-Link:** –
- **IO-Link functions:** –
- **Advanced functions:** –
- **Output type:** PNP/NPN
- **Connection diagram:** cd-086

Fork width	Adjustment	Teach-in mode	Fork depth	Type	Part no.
5 mm	Plus/minus buttons (Sensitivity, light/dark switching)	—	42 mm	WF5-40B410	6028429
			59 mm	WF5-60B410	6028437
			95 mm	WF5-95B410	6028444
	Plus/minus buttons (Teach-in, sensitivity, light/dark switching)	2-point teach-in	42 mm	WF5-40B416	6028451
			59 mm	WF5-60B416	6028458
			95 mm	WF5-95B416	6028465

WF15, Plus/minus buttons

- **IO-Link:** –
- **IO-Link functions:** –
- **Advanced functions:** –
- **Output type:** PNP/NPN
- **Connection diagram:** cd-086

Fork width	Adjustment	Teach-in mode	Fork depth	Type	Part no.
15 mm	Plus/minus buttons (Sensitivity, light/dark switching)	–	42 mm	WF15-40B410	6028430
			59 mm	WF15-60B410	6028438
			95 mm	WF15-95B410	6028445
	Plus/minus buttons (Teach-in, sensitivity, light/dark switching)	2-point teach-in	42 mm	WF15-40B416	6028452
			59 mm	WF15-60B416	6028459
			95 mm	WF15-95B416	6028466

WF30, Plus/minus buttons

- **IO-Link:** –
- **IO-Link functions:** –
- **Advanced functions:** –
- **Output type:** PNP/NPN
- **Connection diagram:** cd-086

Fork width	Adjustment	Teach-in mode	Fork depth	Type	Part no.
30 mm	Plus/minus buttons (Sensitivity, light/dark switching)	–	42 mm	WF30-40B410	6028431
			59 mm	WF30-60B410	6028439
			95 mm	WF30-95B410	6028446
	Plus/minus buttons (Teach-in, sensitivity, light/dark switching)	2-point teach-in	42 mm	WF30-40B416	6028453
			59 mm	WF30-60B416	6028460
			95 mm	WF30-95B416	6028467

WF50, Plus/minus buttons

- **IO-Link:** –
- **IO-Link functions:** –
- **Advanced functions:** –
- **Output type:** PNP/NPN
- **Connection diagram:** cd-086

Fork width	Adjustment	Teach-in mode	Fork depth	Type	Part no.
50 mm	Plus/minus buttons (Sensitivity, light/dark switching)	–	42 mm	WF50-40B410	6028432
			59 mm	WF50-60B410	6028440
			95 mm	WF50-95B410	6028447
	Plus/minus buttons (Teach-in, sensitivity, light/dark switching)	2-point teach-in	42 mm	WF50-40B416	6028454
			59 mm	WF50-60B416	6028461
			95 mm	WF50-95B416	6028468

WF80, Plus/minus buttons

- **IO-Link:** –
- **IO-Link functions:** –
- **Advanced functions:** –
- **Output type:** PNP/NPN
- **Connection diagram:** cd-086

Fork width	Adjustment	Teach-in mode	Fork depth	Type	Part no.
80 mm	Plus/minus buttons (Sensitivity, light/dark switching)	–	42 mm	WF80-40B410	6028433
			59 mm	WF80-60B410	6028441
			95 mm	WF80-95B410	6028448
	Plus/minus buttons (Teach-in, sensitivity, light/dark switching)	2-point teach-in	42 mm	WF80-40B416	6028455
			59 mm	WF80-60B416	6028462
			95 mm	WF80-95B416	6028469

WF120, Plus/minus buttons

- **IO-Link:** –
- **IO-Link functions:** –
- **Advanced functions:** –
- **Output type:** PNP/NPN
- **Connection diagram:** cd-086

Fork width	Adjustment	Teach-in mode	Fork depth	Type	Part no.
120 mm	Plus/minus buttons (Sensitivity, light/dark switching)	–	42 mm	WF120-40B410	6028435
			59 mm	WF120-60B410	6028442
			95 mm	WF120-95B410	6028449
	Plus/minus buttons (Teach-in, sensitivity, light/dark switching)	2-point teach-in	42 mm	WF120-40B416	6028456
			59 mm	WF120-60B416	6028463
			95 mm	WF120-95B416	6028470

Dimensional drawings (Dimensions in mm (inch))

WFnext - Plus/minus buttons

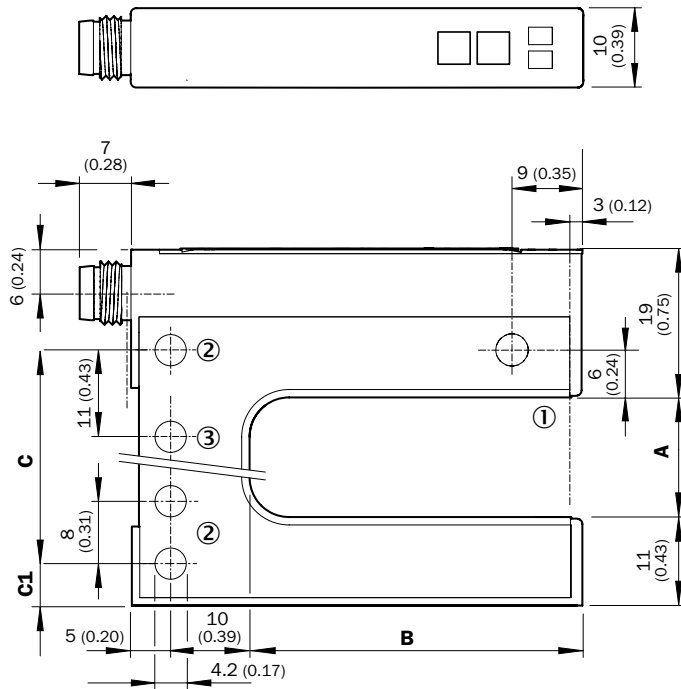

- ① Optical axis
- ② Mounting hole, \varnothing 4.2 mm
- ③ WF50/80/120 only

WFnext - Teach-in button

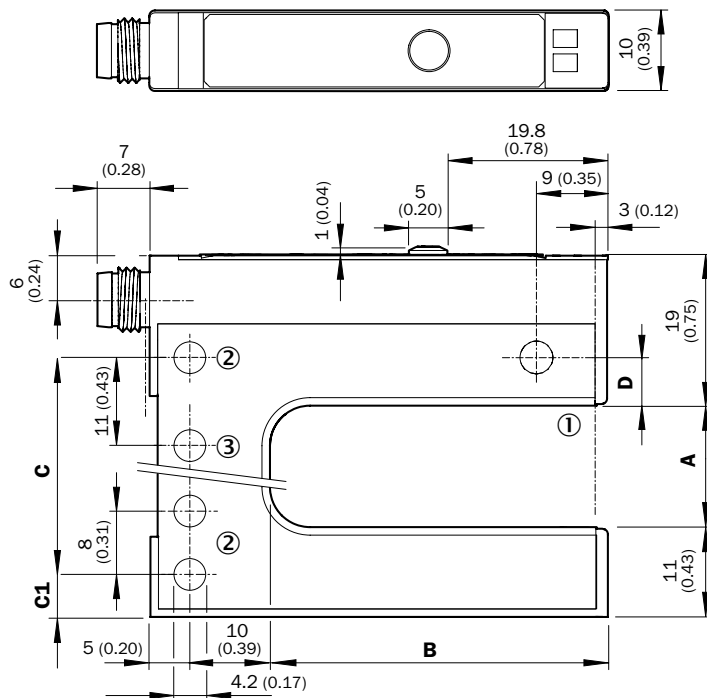

- ① Optical axis
- ② Mounting hole, \varnothing 4.2 mm
- ③ WF50/80/120 only

Dimensions in mm (inch)

	A Fork width	B Fork depth	C	C1
WF2	2 (0.08)	42/59/95 (1.65/2.32/3.74)	14 (0.55)	5 (0.20)
WF5	5 (0.20)	42/59/95 (1.65/2.32/3.74)	14 (0.55)	6.5 (0.20)
WF15	15 (0.59)	42/59/95 (1.65/2.32/3.74)	27 (1.06)	5 (0.20)
WF30	30 (1.18)	42/59/95 (1.65/2.32/3.74)	42 (1.65)	5 (0.20)
WF50	50 (1.97)	42/59/95 (1.65/2.32/3.74)	51 (2.01)	16 (0.63)
WF80	80 (3.15)	42/59/95 (1.65/2.32/3.74)	81 (3.19)	16 (0.63)
WF120	120 (4.72)	42/59/95 (1.65/2.32/3.74)	121 (4.76)	16 (0.63)

Dimensions in mm (inch)

	A Gabelweite/Fork width	B Gabeltiefe/Fork depth
WF2	2 (0.08)	42/59/95 (1.65/2.32/3.74)
WF5	5 (0.20)	42/59/95 (1.65/2.32/3.74)
WF15	15 (0.59)	42/59/95 (1.65/2.32/3.74)
WF30	30 (1.18)	42/59/95 (1.65/2.32/3.74)
WF50	50 (1.97)	42/59/95 (1.65/2.32/3.74)
WF80	80 (3.15)	42/59/95 (1.65/2.32/3.74)
WF120	120 (4.72)	42/59/95 (1.65/2.32/3.74)

	C	C1	D
WF2	14 (0.55)	5 (0.20)	6 (0.24)
WF5	14 (0.55)	6.5 (0.26)	4.5 (0.17)
WF15	27 (1.06)	5 (0.20)	6 (0.24)
WF30	42 (1.65)	5 (0.20)	6 (0.24)
WF50	51 (2.01)	16 (0.63)	6 (0.24)
WF80	81 (3.19)	16 (0.63)	6 (0.24)
WF120	121 (4.76)	16 (0.63)	6 (0.24)

Adjustments

WFnext, Plus/minus buttons (WFxx-B410)

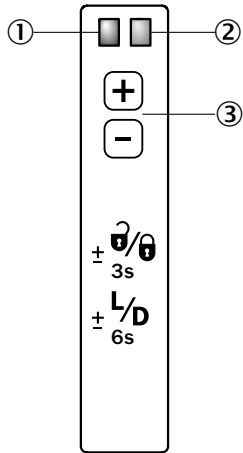

- ① Function signal indicator (yellow), switching output
- ② Function indicator (red)
- ③ Plus/minus buttons and function button

WFnext, Teach-in via plus/minus buttons (WFxx-B416)

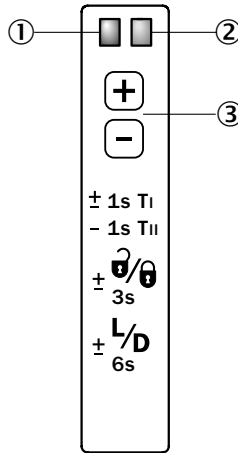

- ① Function signal indicator (yellow), switching output
- ② Function indicator (red)
- ③ Plus/minus buttons and function button

WFnext, Teach-in via Teach-in button (WFxx-B41Cxx)

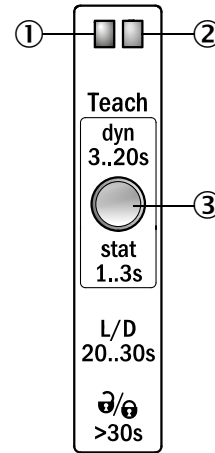

- ① Function signal indicator (yellow), switching output
- ② Function signal indicator (green)
- ③ Teach-in button and function button

Connection diagram

Cd-086

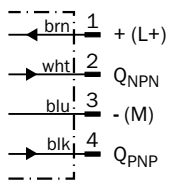

Cd-273

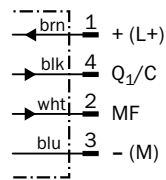

Setting the switching threshold

Setting the switching threshold via plus/minus buttons (WFxx-B410)

1. No object in the beam path

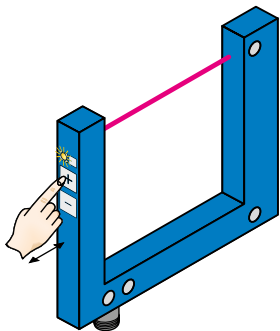

The yellow function indicator illuminates when the light received is at its optimum level. If necessary, increase sensitivity using the "+" button.

2. Object in the beam path

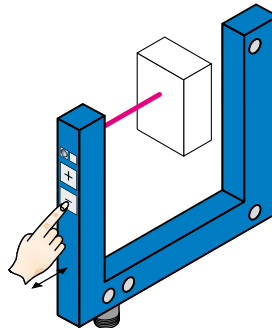

Yellow function indicator goes out. If necessary, reduce sensitivity using the "-" button.

Teach-in via plus/minus buttons (WFxx-B416)

The switching threshold is set automatically. Fine adjustment is possible using the “+”/“–” buttons.

1. No object or substrate in the beam path

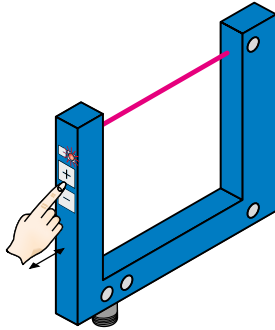

Press the “+” and “–” buttons together and hold for 1 second. The red function indicator flashes slowly.

2. Object or label in the beam path

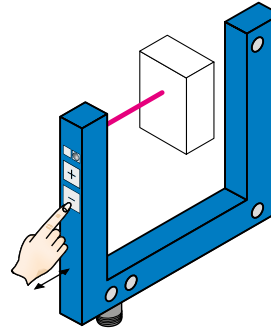

Press the “–” button for 1 second. Red function indicator goes out.

Notes

Material speed = 0 (machine at a standstill).

- + Once teach-in process is complete, the switching threshold can be adjusted at any time using the “+” or “–” button. To make minor adjustments, press the “+” or “–” button once.
- To configure settings quickly, keep the “+” or “–” button pressed for longer.
- $\pm \frac{Q}{3s}$ Press both the “+” and “–” buttons together (3 seconds) to lock the device and prevent unintentional actuation.
- $\pm \frac{L/D}{6s}$ Press both the “+” and “–” buttons together (6 seconds) to define the switching function (light/dark switching). Standard setting: \bar{Q} = light switching.

Teach-in via Teach-in button (WFxx-B41Cxx)

1. Start teach-in: Position the background or object between the fork

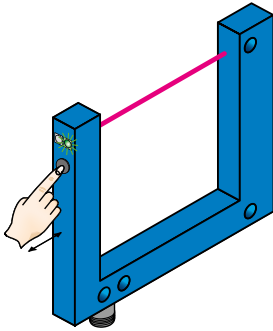

Press the teach-in button for 3 - 20 s. With the pushbutton pressed down, move several objects with carrier material (label objects to be detected) through the sensor. The yellow LED flashes at 3 Hz during the teach-in procedure. Recommendation: Move at least 3 objects through the sensor.

2. End teach-in:

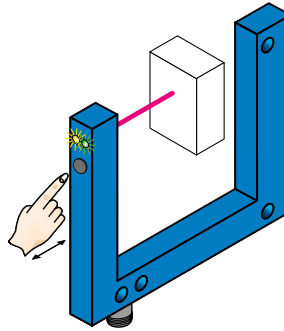

Release the teach-in button for < 20 s. If teach-in is successful, the function indicator (yellow LED) directly indicates the output state of the sensor. The switching threshold is now optimally set between background and object. The best possible operational safety is provided.

Note

Fine adjustment

In order to obtain a higher operating reserve, a fine adjustment can be carried out after successful teach-in. For this purpose, the switching threshold is set close to the taught-in object. The teach-in button must be pressed and released within 10 s of successful teach-in. Successful setting is signaled by flashing twice at 1 Hz.

Light/dark switching

- You can change between light switching and dark switching by pressing the teach-in button for 20 - 30 s.

Pushbutton lock

- The device can be locked against unintended operation by pressing the teach-in button for > 30 s. The device can be unlocked by pressing the teach-in button again for > 30 s.

THE PERFECT SENSOR FOR THE DETECTION OF VERY SMALL PARTS AND PRECISE POSITIONING



Product description

WF Laser fork sensors are characterized by fast response times and a highly focused visible laser beam. The sender and receiver operate using a through-beam design and are in a single housing. No adjustments therefore need to be made. The sensors guarantee exceptionally high positioning accuracy and impress with their extremely fast

response times and very fine resolution. As a result, the sensors are particularly suitable for detecting extremely small objects such as needles or wires. They are also recommended for the detection of transparent objects. A total of 21 WF Laser variants are available for use in a wide range of applications.

At a glance

- Very precise Class 1 laser
- Simple and precise setting of the switching threshold via IO-Link, teach-in button, or plus/minus buttons
- Fast response time: 100 µs
- PNP and NPN switching output
- Light/dark switching function
- Stable aluminum housing with IP 65 enclosure rating
- Smart sensor with integrated IO-Link interface

Your benefits

- A highly precise laser beam ensures consistent measurement accuracy along the entire measuring range and reliable detection of the smallest objects
- A visible laser light spot enables easy alignment and fast adjustment
- Reliable and simple setting via teach-in ensures high process reliability
- A wide range of different fork sizes increases installation flexibility
- The aluminum housing meets all requirements for use in harsh industrial conditions

CDRH



Additional information

Detailed technical data	41
Ordering information	43
Dimensional drawings	47
Adjustments	48
Connection diagram	48
Setting the switching threshold . . .	49

→ www.sick.com/WFL

For more information, simply enter the link or scan the QR code and get direct access to technical data, CAD design models, operating instructions, software, application examples, and much more.



Detailed technical data

Features

	WFL - Teach-in button	WFL - Plus/minus buttons
Functional principle	Optical detection principle	
Housing design (light emission)	Fork shaped	
Fork width	2 mm ... 120 mm (depending on type)	
Fork depth	42 mm ... 95 mm (depending on type)	
Minimum detectable object (MDO)	0.05 mm	
Light source	Laser, visible red light	
Wave length	670 nm	
Laser class	I	
Adjustment	Teach-in button Cable	Plus/minus buttons
Teach-in mode	1-point-teach-in 2-point teach-in Dynamic Teach-in	2-point teach-in
Output function	Light/darkswitching, selectable via button	

Interfaces

	WFL - Teach-in button	WFL - Plus/minus buttons
IO-Link Funktionen	Standard Advanced (depending on type)	-
Advanced Funktionen	Time measurement + decentralized debouncing / High speed counter + decentralized debouncing ¹⁾ (depending on type)	-
Fieldbus, industrial network	IO-Link	-
Type of fieldbus integration	Integrated in the device	-

Mechanics/electronics

	WFL - Teach-in button	WFL - Plus/minus buttons
Supply voltage¹⁾	10 V DC ... 30 V DC	
Ripple²⁾	< 10 %	
Power consumption³⁾	40 mA	
Switching frequency⁴⁾	11 kHz	10 kHz
Response time	60 μ s ⁵⁾	100 μ s
Stability of response time	\pm 20 μ s	
Jitter	22 μ s	40 μ s
Output type	PUSH/PULL	PNP/NPN
Switching output (voltage)	Push/Pull: High = $V_s - < 2 V$ / Low: $\leq 2 V$	PNP: HIGH = $V_s - \leq 2 V$ / LOW approx. 0 V NPN: HIGH = approx. V_s / LOW $\leq 2 V$
Switching output	Light/dark switching	
Output current I_{max}	100 mA	
Input, teach-in (ET)	Teach: $U > 5 V \dots < U_v$ Run: $U < 4 V$	-
Initialization time	40 ms	100 ms
Connection type	Connector M8, 4-pin	
Ambient light immunity	Sunlight: $\leq 10,000$ klx	

	WFL - Teach-in button	WFL - Plus/minus buttons
Protection class ⁶⁾	III	
Circuit protection	U _V connections, reverse polarity protected Output Q short-circuit protected Interference pulse suppression	
Enclosure rating	IP 65	
Weight ⁷⁾	Approx. 36 g ... 160 g	
Housing material	Aluminum	

¹⁾ Limit values, reverse-polarity protected, operation in short-circuit protected network: max. 8 A.

²⁾ May not exceed or fall below U_V tolerances.

³⁾ Without load.

⁴⁾ With light/dark ratio 1:1.

⁵⁾ Signal transit time with resistive load.

⁶⁾ Reference voltage DC 50 V.

⁷⁾ Depending on fork width.

Ambient data

	WFL - Teach-in button	WFL - Plus/minus buttons
Ambient operating temperature ¹⁾	-20 °C ... +50 °C	
Ambient storage temperature	-30 °C ... +80 °C	
Shock load	According to EN 60068-2-27	

¹⁾ Do not bend below 0 °C.

Ordering information

Other models → www.sick.com/WFL

WFL2, Teach-in button

- **IO-Link:** ✓
- **Output type:** PUSH/PULL
- **Connection diagram:** cd-273
- **Adjustment:** Teach-in button (Teach-in, sensitivity, light/dark switching), cable (dynamic Teach-in)

Fork width	Teach-in mode	IO-Link functions	Advanced functions ¹⁾	Fork depth	Type	Part no.
2 mm	1-point-teach-in 2-point teach-in Dynamic Teach-in	Standard	—	42 mm	WFL2-40B41CA00	6058620
				59 mm	WFL2-60B41CA00	6058627
				95 mm	WFL2-95B41CA00	6058635

¹⁾ On request also available with advanced funktions A70 or A71.

WFL5, Teach-in button

- **IO-Link:** ✓
- **Output type:** PUSH/PULL
- **Connection diagram:** cd-273
- **Adjustment:** Teach-in button (Teach-in, sensitivity, light/dark switching), cable (dynamic Teach-in)

Fork width	Teach-in mode	IO-Link functions	Advanced functions ¹⁾	Fork depth	Type	Part no.
5 mm	1-point-teach-in 2-point teach-in Dynamic Teach-in	Standard	—	42 mm	WFL5-40B41CA00	6058621
				59 mm	WFL5-60B41CA00	6058628
				95 mm	WFL5-95B41CA00	6058636

¹⁾ On request also available with advanced funktions A70 or A71.

WFL15, Teach-in button

- **IO-Link:** ✓
- **Output type:** PUSH/PULL
- **Connection diagram:** cd-273
- **Adjustment:** Teach-in button (Teach-in, sensitivity, light/dark switching), cable (dynamic Teach-in)

Fork width	Teach-in mode	IO-Link functions	Advanced functions ¹⁾	Fork depth	Type	Part no.
15 mm	1-point-teach-in 2-point teach-in Dynamic Teach-in	Standard	—	42 mm	WFL15-40B41CA00	6058622
				59 mm	WFL15-60B41CA00	6058629
				95 mm	WFL15-95B41CA00	6058637

¹⁾ On request also available with advanced funktions A70 or A71.

WFL30, Teach-in button

- **IO-Link:** ✓
- **Output type:** PUSH/PULL
- **Connection diagram:** cd-273
- **Adjustment:** Teach-in button (Teach-in, sensitivity, light/dark switching), cable (dynamic Teach-in)

Fork width	Teach-in mode	IO-Link functions	Advanced functions ¹⁾	Fork depth	Type	Part no.
30 mm	1-point-teach-in 2-point teach-in Dynamic Teach-in	Standard	—	42 mm	WFL30-40B41CA00	6058623
				59 mm	WFL30-60B41CA00	6058631
				95 mm	WFL30-95B41CA00	6058638

¹⁾ On request also available with advanced funktions A70 or A71.

WFL50, Teach-in button

- **IO-Link:** ✓
- **Output type:** PUSH/PULL
- **Connection diagram:** cd-273
- **Adjustment:** Teach-in button (Teach-in, sensitivity, light/dark switching), cable (dynamic Teach-in)

Fork width	Teach-in mode	IO-Link functions	Advanced functions	Fork depth	Type	Part no.
50 mm	1-point-teach-in 2-point teach-in Dynamic Teach-in	Standard	—	42 mm	WFL50-40B41CA00	6058624
		Advanced	Time measurement + decentralized debouncing	42 mm	WFL50-40B41CA70	6058645
			High speed counter + decentralized debouncing	42 mm	WFL50-40B41CA71	6058646
		Standard	— ¹⁾	59 mm	WFL50-60B41CA00	6058632
				95 mm	WFL50-95B41CA00	6058639

¹⁾ On request also available with advanced funktions A70 or A71.

WFL80, Teach-in button

- **IO-Link:** ✓
- **Output type:** PUSH/PULL
- **Connection diagram:** cd-273
- **Adjustment:** Teach-in button (Teach-in, sensitivity, light/dark switching), cable (dynamic Teach-in)

Fork width	Teach-in mode	IO-Link functions	Advanced functions ¹⁾	Fork depth	Type	Part no.
80 mm	1-point-teach-in 2-point teach-in Dynamic Teach-in	Standard	—	42 mm	WFL80-40B41CA00	6058625
				59 mm	WFL80-60B41CA00	6058633
				95 mm	WFL80-95B41CA00	6058640

¹⁾ On request also available with advanced funktions A70 or A71.

WFL120, Teach-in button

- **IO-Link:** ✓
- **Output type:** PUSH/PULL
- **Connection diagram:** cd-273
- **Adjustment:** Teach-in button (Teach-in, sensitivity, light/dark switching), cable (dynamic Teach-in)

Fork width	Teach-in mode	IO-Link functions	Advanced functions ¹⁾	Fork depth	Type	Part no.
120 mm	1-point-teach-in 2-point teach-in Dynamic Teach-in	Standard	–	42 mm	WFL120-40B41CA00	6058626
				59 mm	WFL120-60B41CA00	6058634
				95 mm	WFL120-95B41CA00	6058641

¹⁾ On request also available with advanced funktions A70 or A71.

WFL2, Plus/minus buttons

- **IO-Link:** –
- **IO-Link functions:** –
- **Advanced functions:** –
- **Output type:** PNP/NPN
- **Connection diagram:** cd-086

Fork width	Adjustment	Teach-in mode	Fork depth	Type	Part no.
2 mm	Plus/minus buttons (Teach-in, sensitivity, light/dark switching)	2-point teach-in	42 mm	WFL2-40B416	6036821
			59 mm	WFL2-60B416	6036828
			95 mm	WFL2-95B416	6036835

WFL5, Plus/minus buttons

- **IO-Link:** –
- **IO-Link functions:** –
- **Advanced functions:** –
- **Output type:** PNP/NPN
- **Connection diagram:** cd-086

Fork width	Adjustment	Teach-in mode	Fork depth	Type	Part no.
5 mm	Plus/minus buttons (Teach-in, sensitivity, light/dark switching)	2-point teach-in	42 mm	WFL5-40B416	6036822
			59 mm	WFL5-60B416	6036829
			95 mm	WFL5-95B416	6036836

WFL15, Plus/minus buttons

- **IO-Link:** –
- **IO-Link functions:** –
- **Advanced functions:** –
- **Output type:** PNP/NPN
- **Connection diagram:** cd-086

Fork width	Adjustment	Teach-in mode	Fork depth	Type	Part no.
15 mm	Plus/minus buttons (Teach-in, sensitivity, light/dark switching)	2-point teach-in	42 mm	WFL15-40B416	6036823
			59 mm	WFL15-60B416	6036830
			95 mm	WFL15-95B416	6036837

WFL30, Plus/minus buttons

- **IO-Link:** –
- **IO-Link functions:** –
- **Advanced functions:** –
- **Output type:** PNP/NPN
- **Connection diagram:** cd-086

Fork width	Adjustment	Teach-in mode	Fork depth	Type	Part no.
30 mm	Plus/minus buttons (Teach-in, sensitivity, light/dark switching)	2-point teach-in	42 mm	WFL30-40B416	6036824
			59 mm	WFL30-60B416	6036831
			95 mm	WFL30-95B416	6036838

WFL50, Plus/minus buttons

- **IO-Link:** –
- **IO-Link functions:** –
- **Advanced functions:** –
- **Output type:** PNP/NPN
- **Connection diagram:** cd-086

Fork width	Adjustment	Teach-in mode	Fork depth	Type	Part no.
50 mm	Plus/minus buttons (Teach-in, sensitivity, light/dark switching)	2-point teach-in	42 mm	WFL50-40B416	6036825
			59 mm	WFL50-60B416	6036832
			95 mm	WFL50-95B416	6036839

WFL80, Plus/minus buttons

- **IO-Link:** –
- **IO-Link functions:** –
- **Advanced functions:** –
- **Output type:** PNP/NPN
- **Connection diagram:** cd-086

Fork width	Adjustment	Teach-in mode	Fork depth	Type	Part no.
80 mm	Plus/minus buttons (Teach-in, sensitivity, light/dark switching)	2-point teach-in	42 mm	WFL80-40B416	6036826
			59 mm	WFL80-60B416	6036833
			95 mm	WFL80-95B416	6036840

WFL120, Plus/minus buttons

- **IO-Link:** –
- **IO-Link functions:** –
- **Advanced functions:** –
- **Output type:** PNP/NPN
- **Connection diagram:** cd-086

Fork width	Adjustment	Teach-in mode	Fork depth	Type	Part no.
120 mm	Plus/minus buttons (Teach-in, sensitivity, light/dark switching)	2-point teach-in	42 mm	WFL120-40B416	6036827
			59 mm	WFL120-60B416	6036834
			95 mm	WFL120-95B416	6036841

Adjustments

WFL, Plus/minus buttons

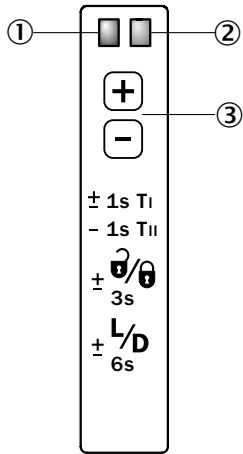

- ① Function signal indicator (yellow), switching output
- ② Function indicator (red)
- ③ Plus/minus buttons and function button

WFL, Teach-in button

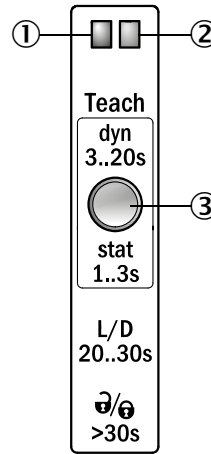

- ① Function signal indicator (yellow), switching output
- ② Function signal indicator (green)
- ③ Teach-in button and function button

Connection diagram

Cd-273

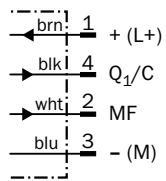

Cd-086

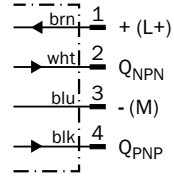

Setting the switching threshold

Teach-in via plus/minus buttons

The switching threshold is set automatically. Fine adjustment is possible using the “+”/“–” buttons.

1. No object or substrate in the beam path

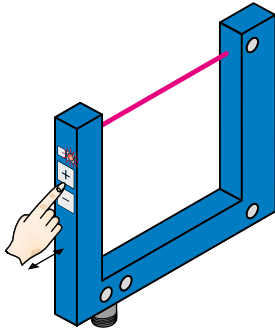

Press the “+” and “–” buttons together and hold for 1 second. The red function indicator flashes slowly.

2. Object or label in the beam path

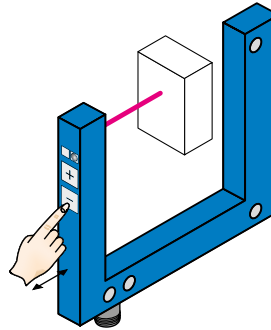

Press the “–” button for 1 second. Red function indicator goes out.

Notes

Material speed = 0 (machine at a standstill).

- + Once teach-in process is complete, the switching threshold can be adjusted at any time using the “+” or “–” button. To make minor adjustments, press the “+” or “–” button once.
- To configure settings quickly, keep the “+” or “–” button pressed for longer.

$\pm \frac{0}{3s}$ Press both the “+” and “–” buttons together (3 seconds) to lock the device and prevent unintentional actuation.

$\pm \frac{L/D}{6s}$ Press both the “+” and “–” buttons together (6 seconds) to define the switching function (light/dark switching). Standard setting: \bar{Q} = light switching.

Teach-in via Teach-in button

1. Start teach-in: Position the background or object between the fork

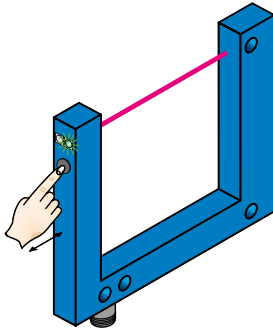

Press the teach-in button for 3 - 20 s. With the pushbutton pressed down, move several objects with carrier material (label objects to be detected) through the sensor. The yellow LED flashes at 3 Hz during the teach-in procedure. Recommendation: Move at least 3 objects through the sensor.

2. End teach-in:

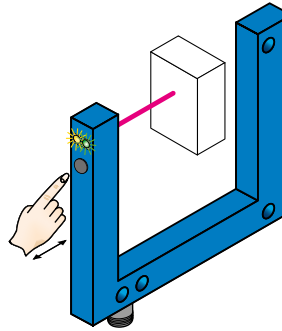

Release the teach-in button for < 20 s. If teach-in is successful, the function indicator (yellow LED) directly indicates the output state of the sensor. The switching threshold is now optimally set between background and object. The best possible operational safety is provided.

Note

Fine adjustment

In order to obtain a higher operating reserve, a fine adjustment can be carried out after successful teach-in. For this purpose, the switching threshold is set close to the taught-in object. The teach-in button must be pressed and released within 10 s of successful teach-in. Successful setting is signaled by flashing twice at 1 Hz.

Light/dark switching

- You can change between light switching and dark switching by pressing the teach-in button for 20 - 30 s.

Pushbutton lock

- The device can be locked against unintended operation by pressing the teach-in button for > 30 s. The device can be unlocked by pressing the teach-in button again for > 30 s.

PLUG-AND-PLAY FORK SENSORS – CONNECT AND GET STARTED



Product description

The WFM fork sensors are extremely quick and easy to mount and commission thanks to plug and play. Their yellow receive indicator can be seen all the way round, providing optimum feedback on the switching behavior of the WFM. Since the sender and receiver are integrated within the same housing, there is no need for any complex alignment work, allowing detection tasks to be prepared and completed quickly and

easily. WFM have a rugged aluminum housing and are available in five different designs with fork widths ranging from 30 mm to 180 mm and fork depths of between 40 mm and 120 mm. SICK's fork sensors are suited to numerous applications, such as detecting parts in production processes, checking whether various objects are present, or intralogistic processes.

At a glance

- Clearly visible red emitted light
- No setup required: The sensor is ready for operation immediately
- Receive indicator, visible all-round
- 5 fork sizes with a maximum depth of 120 mm and a maximum width of 180 mm
- Stable aluminum housing with IP 67 enclosure rating

Your benefits

- Fixed parameters guarantee a high level of operational safety with extremely simple commissioning
- A visible red light enables easy alignment of the WFM
- The all-round visible receive indicator enables constant process control
- A wide range of different fork sizes increases installation flexibility
- Stable aluminum housing for use in harsh industrial environments



Additional information

Detailed technical data	53
Ordering information	55
Dimensional drawing	56
Connection diagram	56

→ www.sick.com/WFM

For more information, simply enter the link or scan the QR code and get direct access to technical data, CAD design models, operating instructions, software, application examples, and much more.



Detailed technical data

Features

Functional principle	Optical detection principle
Housing design (light emission)	Fork shaped
Fork width	30 mm ... 180 mm (depending on type)
Fork depth	42 mm ... 124 mm (depending on type)
Minimum detectable object (MDO)	0.8 mm 1 mm (depending on type)
Light source	LED, visible red light
Adjustment	None
Output function	Dark switching / Light switching (depending on type)

Interfaces

IO-Link Funktionen	-
Advanced Funktionen	-
Fieldbus, industrial network	-
Type of fieldbus integration	-

Mechanics/electronics

Supply voltage ¹⁾	10 V DC ... 30 V DC
Ripple ²⁾	< 10 %
Power consumption ³⁾	< 20 mA
Switching frequency ⁴⁾	4 kHz
Response time ⁵⁾	125 µs
Stability of response time	± 15 µs
Output type	PNP / NPN (depending on type)
Switching output (voltage)	PNP: HIGH = $V_S - \leq 1.5 \text{ V}$ / LOW = 0 V NPN: HIGH = approx. V_S / LOW $\leq 1.5 \text{ V}$
Switching output	Dark switching / Light switching (depending on type)
Output current I_{max}	100 mA
Initialization time	140 ms
Connection type	Connector M8, 3-pin Cable, 3-wire, 2 m (depending on type)
Ambient light immunity	Sunlight: $\leq 10,000 \text{ klx}$
Protection class ⁶⁾	III
Circuit protection	U_V connections, reverse polarity protected Output Q short-circuit protected Interference pulse suppression
Enclosure rating	IP 67

Weight	Approx. 80 g ... 190 g
Housing material	Aluminum

¹⁾ Limit values, reverse-polarity protected, operation in short-circuit protected network: max. 8 A.

²⁾ May not exceed or fall below U_v tolerances.

³⁾ Without load.

⁴⁾ With light/dark ratio 1:1.

⁵⁾ Signal transit time with resistive load.

⁶⁾ Reference voltage DC 50 V.

⁷⁾ Depending on fork width.

Ambient data

Ambient operating temperature ¹⁾	-10 °C ... +60 °C
Ambient storage temperature	-40 °C ... +80 °C
Shock load	According to EN 60068-2-27
UL File No.	NRKH.E191603 & NRKH7.E191603

¹⁾ Do not bend below 0 °C.

Ordering information

Other models → www.sick.com/WFM

WFM30-40

- **IO-Link:** –
- **Fork width:** 30 mm
- **Fork depth:** 42 mm

MDO	Connection type	Output type	Switching output	Type	Part no.
0.8 mm	Connector M8, 3-pin	PNP	Dark switching	WFM30-40P321	6037819
			Light switching	WFM30-40P311	6037820
		NPN	Dark switching	WFM30-40N321	6037821
			Light switching	WFM30-40N311	6037822
	Cable, 3-wire 2 m	PNP	Dark switching	WFM30-40P121	6037823

WFM50-60

- **IO-Link:** –
- **Fork width:** 50 mm
- **Fork depth:** 60 mm

MDO	Connection type	Output type	Switching output	Type	Part no.
0.8 mm	Connector M8, 3-pin	PNP	Dark switching	WFM50-60P321	6037824
			Light switching	WFM50-60P311	6037825
		NPN	Dark switching	WFM50-60N321	6037826
			Light switching	WFM50-60N311	6037827

WFM80-60

- **IO-Link:** –
- **Fork width:** 80 mm
- **Fork depth:** 60 mm

MDO	Connection type	Output type	Switching output	Type	Part no.
0.8 mm	Connector M8, 3-pin	PNP	Dark switching	WFM80-60P321	6037828
			Light switching	WFM80-60P311	6037829
		NPN	Dark switching	WFM80-60N321	6037830
			Light switching	WFM80-60N311	6037831

WFM120-120

- **IO-Link:** –
- **Fork width:** 120 mm
- **Fork depth:** 124 mm

MDO	Connection type	Output type	Switching output	Type	Part no.
0.8 mm	Connector M8, 3-pin	PNP	Dark switching	WFM120-120P321	6037832
			Light switching	WFM120-120P311	6037833
		NPN	Dark switching	WFM120-120N321	6037834
			Light switching	WFM120-120N311	6037835

WFM180-120

- **IO-Link:** -
- **Fork width:** 180 mm
- **Fork depth:** 124 mm

MDO	Connection type	Output type	Switching output	Type	Part no.
1 mm	Connector M8, 3-pin	PNP	Dark switching	WFM180-120P321	6037836
			Light switching	WFM180-120P311	6037837
		NPN	Dark switching	WFM180-120N321	6037838
			Light switching	WFM180-120N311	6037839

Dimensional drawing (Dimensions in mm (inch))

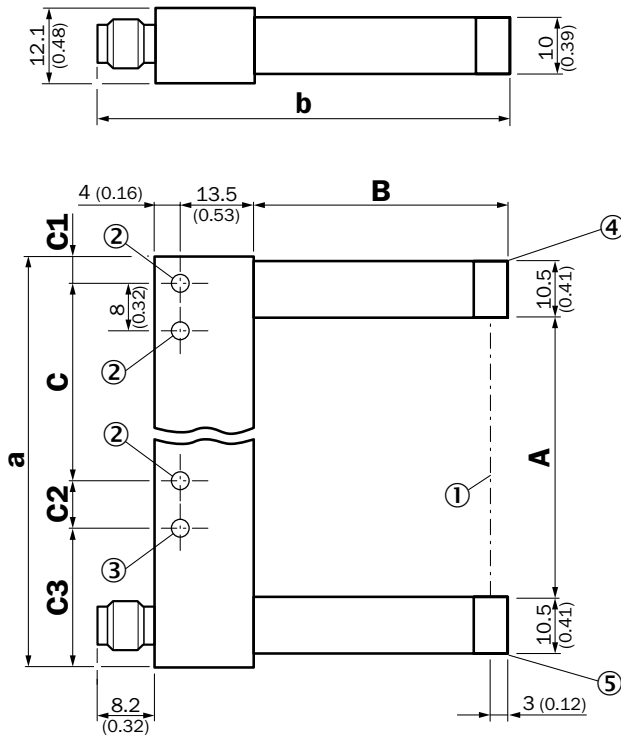

Dimensions in mm (inch)

	A Fork width	B Fork depth	C	C1
WFM30	30 (1.18)	42 (1.65)	30 (1.18)	6.5 (0.26)
WFM50	50 (1.97)	60 (2.36)	40 (1.57)	6.5 (0.26)
WFM80	80 (3.15)	60 (2.36)	70 (2.76)	6.5 (0.26)
WFM120	120 (4.72)	124.3 (4.89)	100 (3.94)	17 (0.67)
WFM180	180 (7.09)	124.3 (4.89)	152 (5.98)	22 (0.87)

	C2	C3	a	b
WFM30	- (-)	- (-)	54 (2.13)	67.7 (2.67)
WFM50	8 (0.31)	19.5 (0.77)	74 (2.91)	85.7 (3.37)
WFM80	8 (0.31)	19.5 (0.77)	104 (4.09)	85.7 (3.37)
WFM120	10 (0.39)	17 (0.67)	144 (5.67)	150.2 (5.91)
WFM180	8 (0.31)	22 (0.87)	204 (8.03)	150.2 (5.91)

- ① Optical axis
- ② Mounting hole, Ø 4.3 mm
- ③ WFM50/80/120/180
- ④ Transmitted light (red)
- ⑤ Function signal indicator (yellow), switching output

Connection diagram

Cd-045

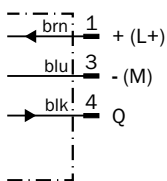

Accessories

Mounting systems



Universal bar clamp systems

Material	Description	Type	Part no.	UFnext	WFS	WFnext	WFL	WFM
Steel, zinc coated	Mounting bar, straight	BEF-M12GF-A	2059414	-	●	-	-	-

Connection systems

Modules and gateways

Connection modules

Figure	Brief description	Type	Part no.	UFnext	WFS	WFnext	WFL	WFM
	IO-Link version V1.1, Port class 2, PIN 2, 4, 5 galvanically connected, Supply voltage 18 V DC ... 32 V DC (limit values, operation in short-circuit protected network max. 8 A)	IOLP2ZZ-M3201 (SICK Memory Stick)	1064290	-	●	●	●	-
	IO-Link V1.1 Class A port, USB2.0 port, optional external power supply 24V / 1A	IOLA2US-01101 (SiLink2 Master)	1061790	-	●	●	●	-

Fieldbus modules





Figure	Brief description	Type	Part no.	UFnext	WFS	WFnext	WFL	WFM
	EtherCAT IO-Link Master, IO-Link V1.1, power supply via 7/8" cable 24 V / 8 A, fieldbus connection via M12 cable	IOLG2EC-03208R01 (IO-Link Master)	6053254	-	-	●	●	-
	EtherNet/IP IO-Link Master, IO-Link V1.1, power supply via 7/8" cable 24 V / 8 A, fieldbus connection via M12-cable	IOLG2EI-03208R01 (IO-Link Master)	6053255	-	-	●	●	-

Figure	Brief description	Type	Part no.	UFnext	WFS	WFnext	WFL	WFM
	PROFINET IO-Link Master, IO-Link V1.1, Class A port, power supply via 7/8" cable 24 V / 8 A, fieldbus connection via M12 cable	IOLG2PN-03208R01 (IO-Link Master)	6053253	-	-	●	●	-

Plug connectors and cables



Connecting cables with female connector M8, 4-pin, PVC, chemical resistant

- **Cable material:** PVC
- **Locking nut material:** CuZn, nickel-plated brass

Figure	Connection type head A	Connection type head B	Connecting cable	Connector material	Type	Part no.	UFnext	WFS	WFnext	WFL	WFM
	Female connector, M8, 4-pin, straight, unshielded	Cable, open conductor heads	2 m, 4-wire	TPU	DOL-0804-G02M	6009870	●	●	●	●	●
			5 m, 4-wire	TPU	DOL-0804-G05M	6009872	●	●	●	●	●
			10 m, 4-wire	TPU	DOL-0804-G10M	6010754	●	●	●	●	●
	Female connector, M8, 4-pin, angled, unshielded	Cable, open conductor heads	2 m, 4-wire	PVC	DOL-0804-W02M	6009871	●	●	●	●	●
			5 m, 4-wire	PVC	DOL-0804-W05M	6009873	●	●	●	●	●
			10 m, 4-wire	PVC	DOL-0804-W10M	6010755	●	●	●	●	●

Female connectors (ready to assemble) M8, 4-pin

- **Locking nut material:** CuZn

Figure	Connection type head A	Connection type head B	Connector material	Locking nut material	Type	Part no.	UFnext	WFS	WFnext	WFL	WFM
	Female connector, M8, 4-pin, straight, unshielded	screw-type terminals	PBT/PA	CuZn	DOS-0804-G	6009974	●	●	●	●	●
	Female connector, M8, 4-pin, angled, unshielded	solder connection	PA/Zinc diecast	CuZn	DOS-0804-W	6009975	●	●	●	●	●

Dimensional drawings Universal bar clamp systems

BEF-M12GF-A

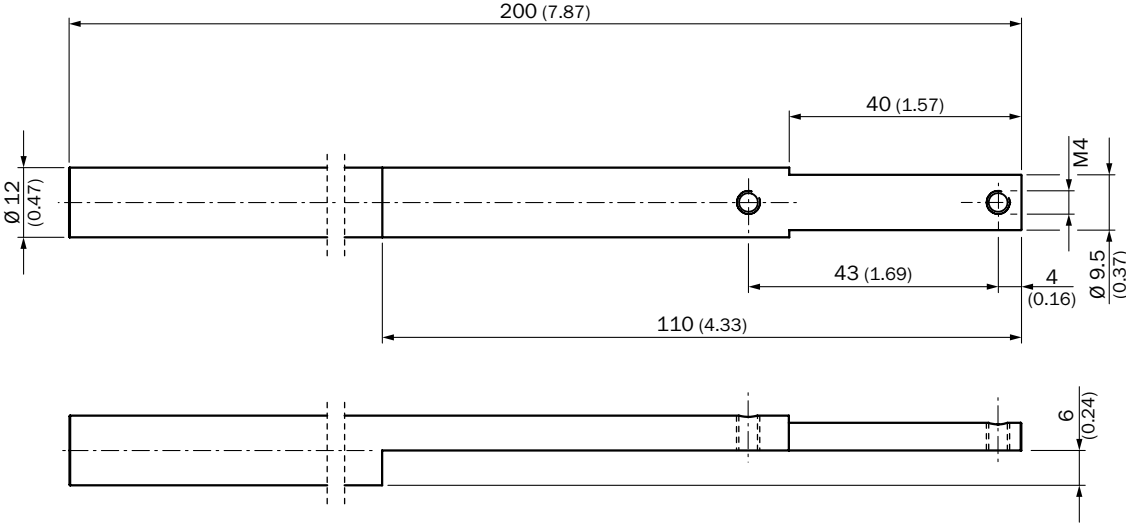

Modules and gateways

IOLP2ZZ-M3201 (SICK Memory Stick)

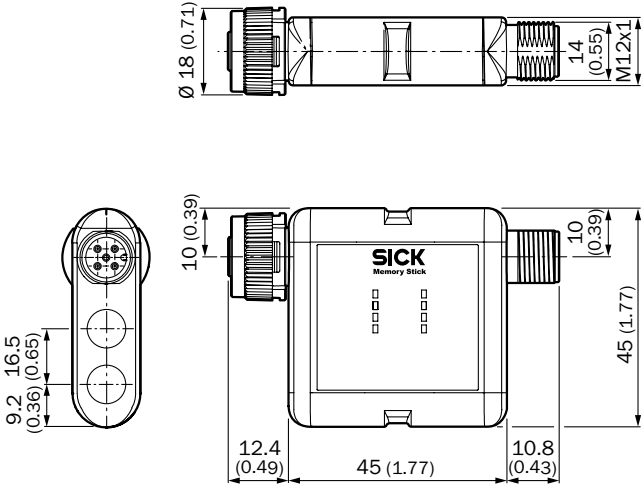

IOLA2US-01101 (SiLink2 Master)

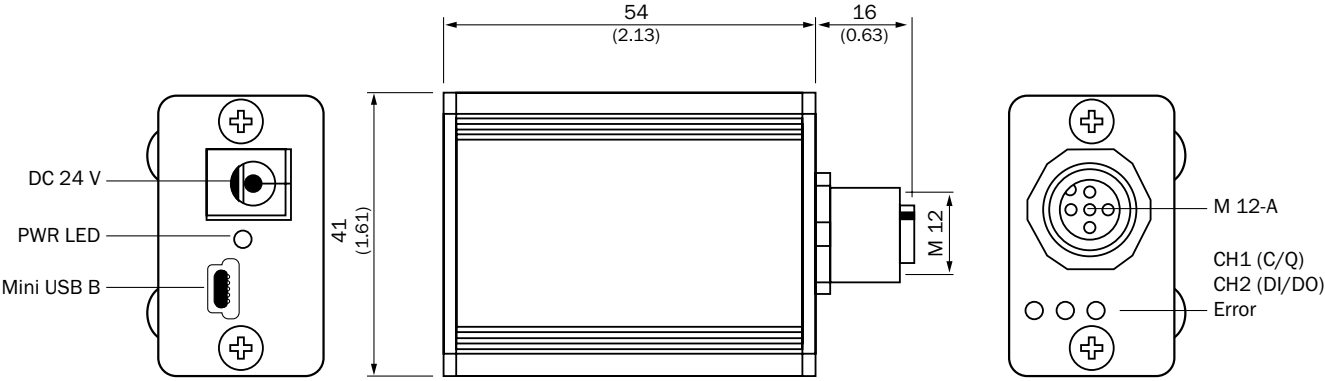

IOLG2EC-03208R01 (IO-Link Master)

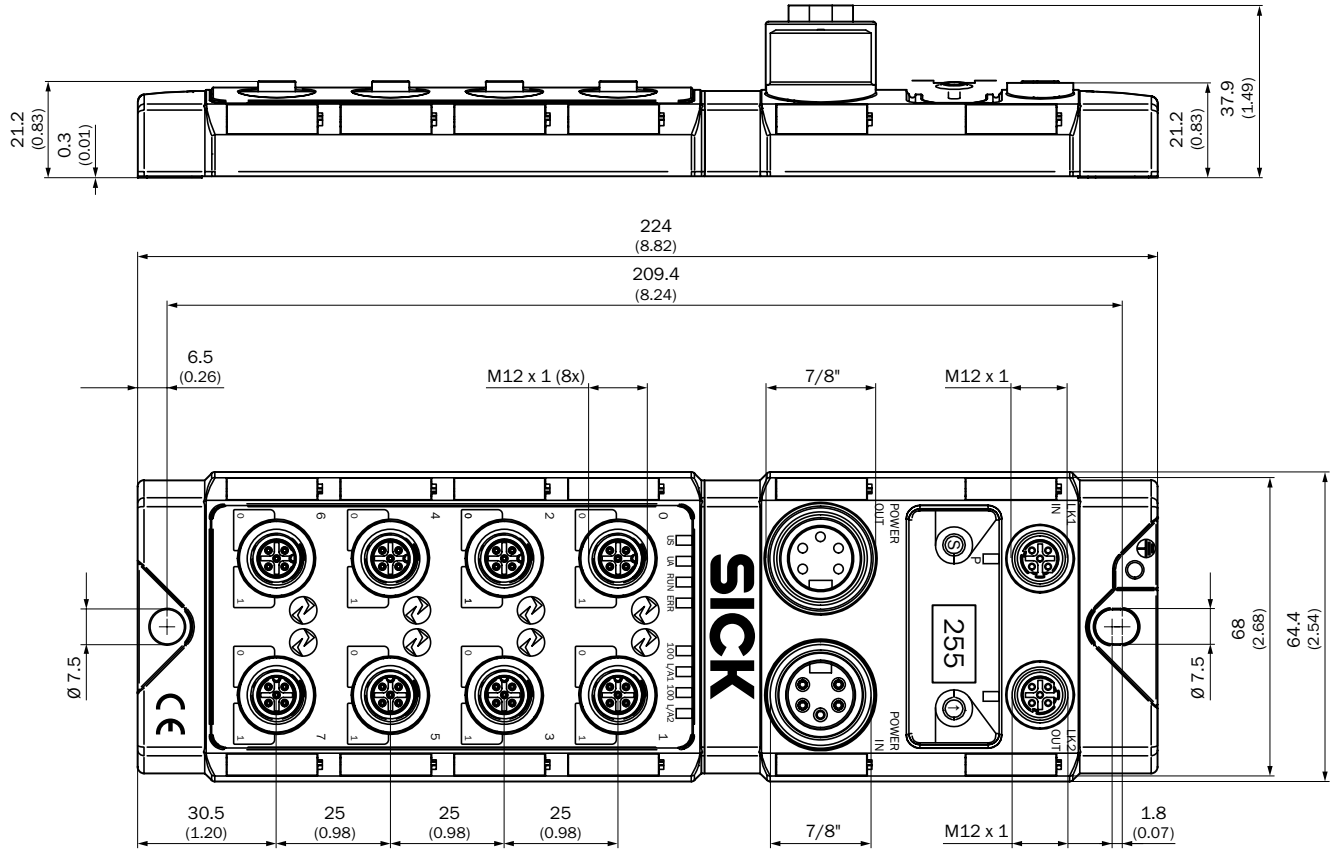

IOLG2EI-03208R01 (IO-Link Master)

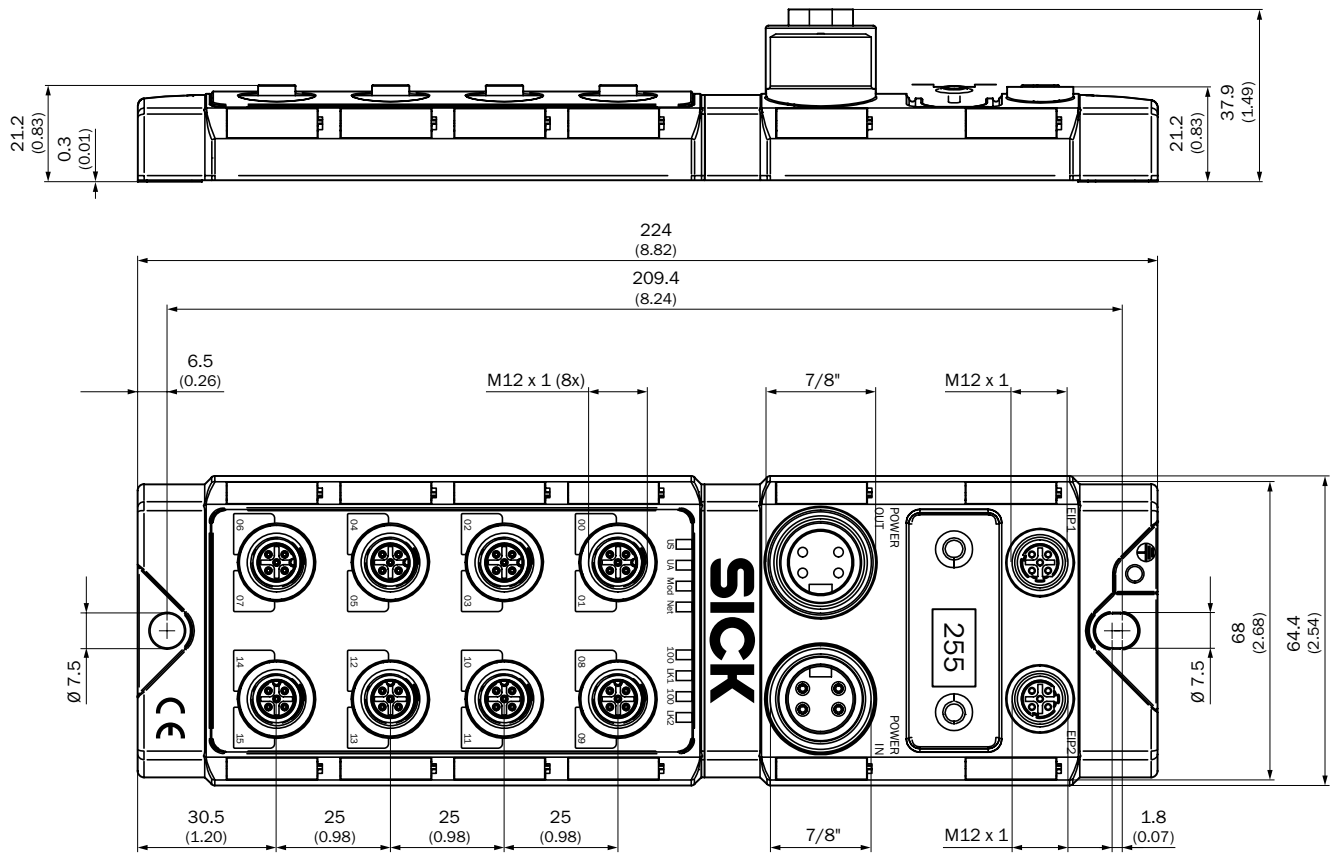

IOLG2PN-03208R01 (IO-Link Master)

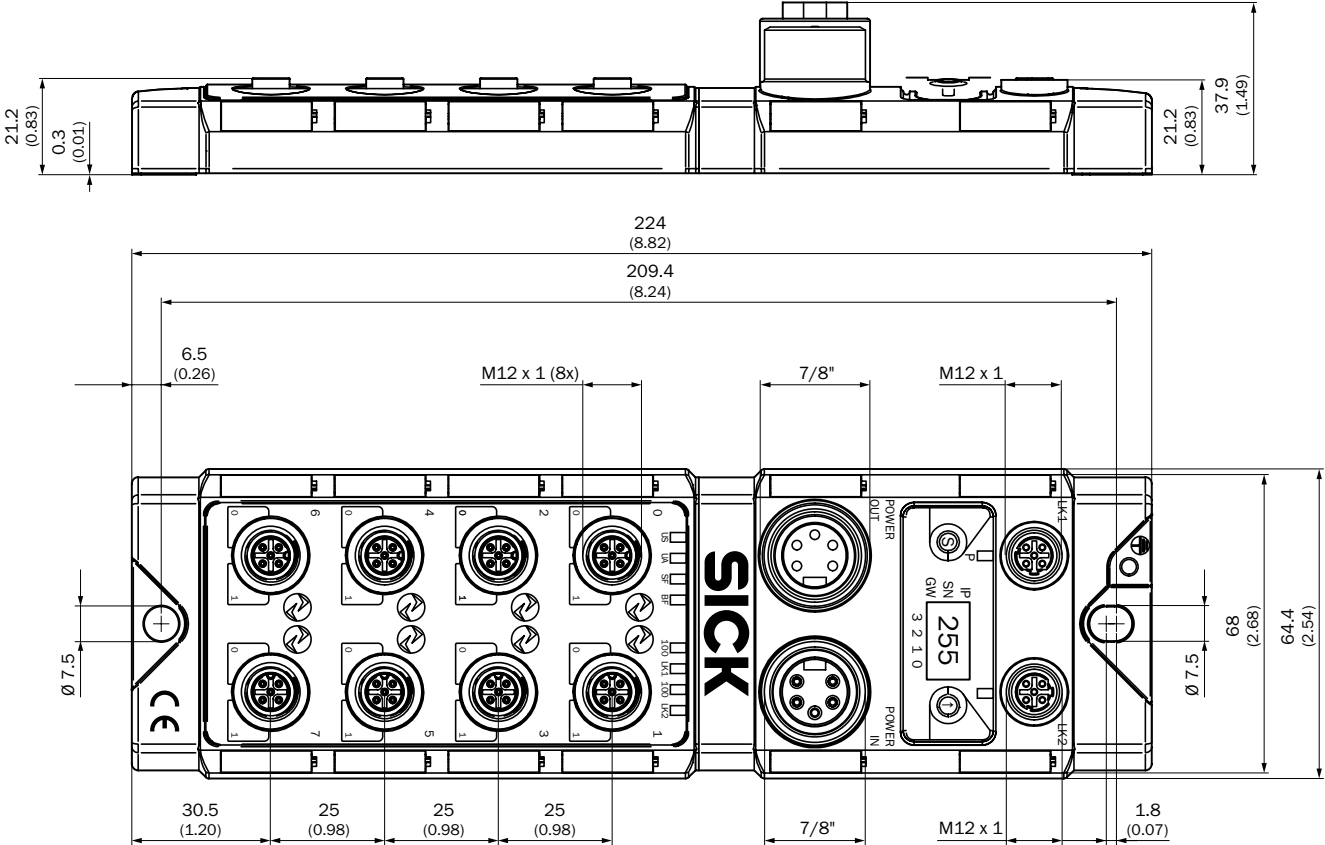

Dimensional drawings Connection systems

DOL-0804-G02M, DOL-0804-G05M, DOL-0804-G10M

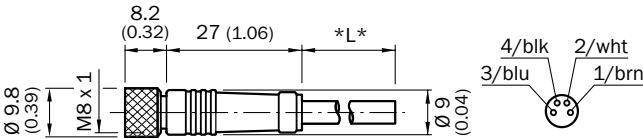

DOL-0804-W02M, DOL-0804-W05M, DOL-0804-W10M

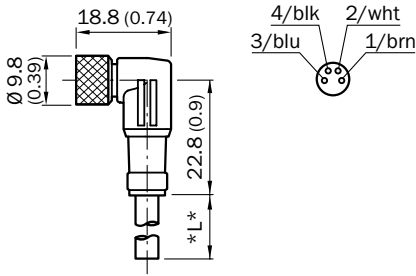

DOS-0804-G

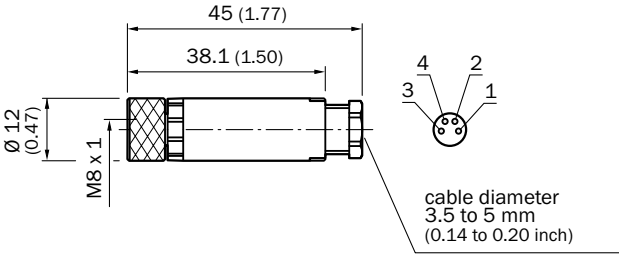

DOS-0804-W

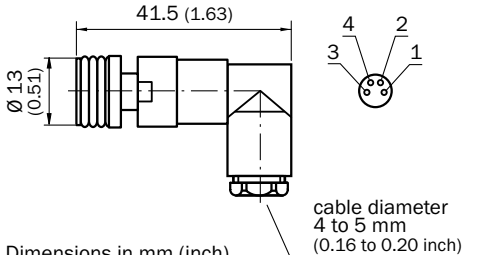

REGISTER AT WWW.SICK.COM TODAY AND ENJOY ALL THE BENEFITS



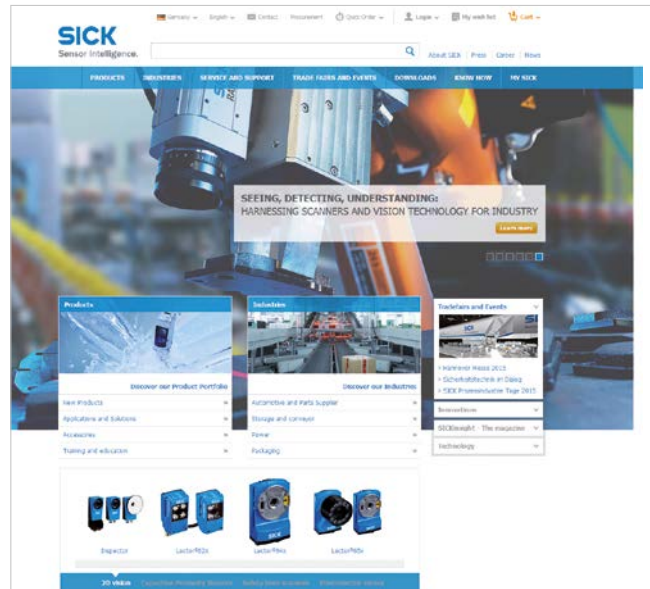

- ✔ Select products, accessories, documentation and software quickly and easily.
- ✔ Create, save and share personalized wish lists.
- ✔ View the net price and date of delivery for every product.
- ✔ Requests for quotation, ordering and delivery tracking made easy.
- ✔ Overview of all quotations and orders.
- ✔ Direct ordering: submit even very complex orders in moments.
- ✔ View the status of quotations and orders at any time. Receive e-mail notifications of status changes.
- ✔ Easily repeat previous orders.
- ✔ Conveniently export quotations and orders to work with your systems.



SERVICES FOR MACHINES AND SYSTEMS: SICK LifeTime Services

Our comprehensive and versatile LifeTime Services are the perfect addition to the comprehensive range of products from SICK. The services range from product-independent consulting to traditional product services.



- 
Consulting and design
 Safe and professional
- 
Product and system support
 Reliable, fast and on-site
- 
Verification and optimization
 Safe and regularly inspected
- 
Upgrade and retrofits
 Easy, safe and economical
- 
Training and education
 Practical, focused and professional

SICK AT A GLANCE

SICK is a leading manufacturer of intelligent sensors and sensor solutions for industrial applications. With more than 7,400 employees and over 50 subsidiaries and equity investments as well as numerous agencies worldwide, we are always close to our customers. A unique range of products and services creates the perfect basis for controlling processes securely and efficiently, protecting individuals from accidents and preventing damage to the environment.

We have extensive experience in various industries and understand their processes and requirements. With intelligent sensors, we can deliver exactly what our customers need. In application centers in Europe, Asia and North America, system solutions are tested and optimized in accordance with customer specifications. All this makes us a reliable supplier and development partner.

Comprehensive services round out our offering: SICK LifeTime Services provide support throughout the machine life cycle and ensure safety and productivity.

For us, that is “Sensor Intelligence.”

Worldwide presence:

Australia, Austria, Belgium, Brazil, Canada, Chile, China, Czech Republic, Denmark, Finland, France, Germany, Great Britain, Hungary, India, Israel, Italy, Japan, Malaysia, Mexico, Netherlands, New Zealand, Norway, Poland, Romania, Russia, Singapore, Slovakia, Slovenia, South Africa, South Korea, Spain, Sweden, Switzerland, Taiwan, Thailand, Turkey, United Arab Emirates, USA, Vietnam.

Detailed addresses and further locations → www.sick.com