

### FEATURES

- High flow rate up to 1400 l/min
- Spool & Sleeve or rubber packed technology in the same dimension body
- Wide electrical connection selection : G3 or 580 Fieldbus Electronics, 25 or 37 Pin Sub-D connector, 19 Pin Round connector, 26 Pin Round connector or Terminal Strip
- Internal or external pilot pressure supply capability and compliance with ISO standard 15407-2 26 mm
- Solenoid air operated valves which can be mounted on manifold bases
- 580 Electronics

### GENERAL

**Operating pressure** See «SPECIFICATIONS» [1 bar =100 kPa]  
**Ambient temperature range (TS)** See «SPECIFICATIONS»  
**Rated flow** See «SPECIFICATIONS»  
 conforming to ISO 6358 C (5/2) =  $5,21 \times 10^{-8} \text{ m}^3/\text{s.Pa}$  (sonic conductance)  
 b (5/2) = 0,34 (critical pressure ratio)  
**Pneumatic base** High flow subbase or ISO 15407-2 26 mm  
**Connection** Joinable subbase  
**Response time** See «SPECIFICATIONS»



fluids (*)	temperature range (TS)	technology	seal materials (*)
air or inert gas ISO 8573 Level 7.4.4	-10°C to +50°C	rubber packed	PUR (polyurethane)
	-10°C to +50°C	spool & sleeve	metal-to-metal sealing

### CONSTRUCTION

MATERIALS IN CONTACT WITH FLUID	
(*) Ensure that the compatibility of the fluids in contact with the materials is verified	
<b>Body</b>	Aluminium, E-coating treatment
<b>Spool</b>	Aluminium or st. steel (spool & sleeve)
<b>Piston</b>	POM (rubber packed)
<b>Spring</b>	Steel
<b>Other seals</b>	NBR
<b>Other materials</b>	PAM (polyarylamide) , GF 50% (glass fiber reinforced)
<b>Subbases</b>	Aluminium, E-coating treatment

### ELECTRICAL CHARACTERISTICS

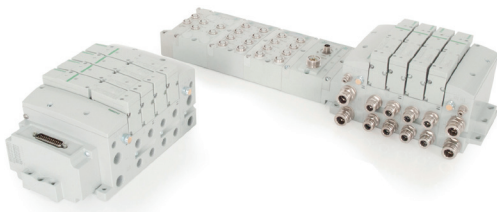

<b>Coil insulation class</b>	F
<b>Electrical safety</b>	IEC-EN 60730-1 / IEC-EN 60730-2-8
<b>Electrical enclosure protection</b>	IP65 (EN 60529)
<b>Standard voltages</b>	DC (=) : 24V
<b>power ratings (hot/cold) (=)</b>	1,4 W / 1,7 W



**503 series**

**SPECIFICATIONS**

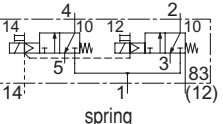
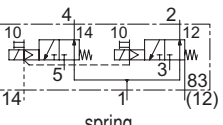
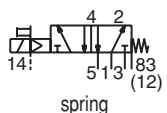
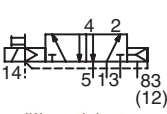
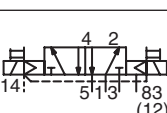
**15-DIGIT PRODUCT CODE**

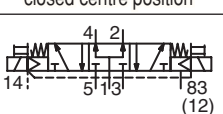
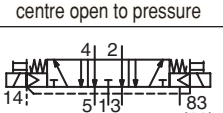

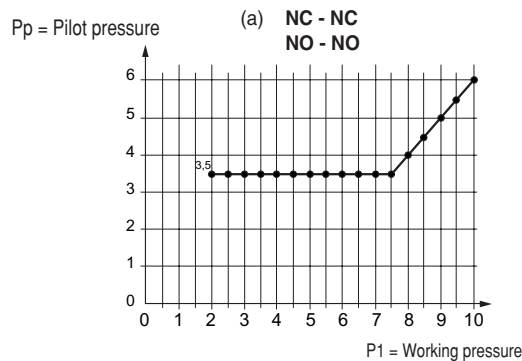

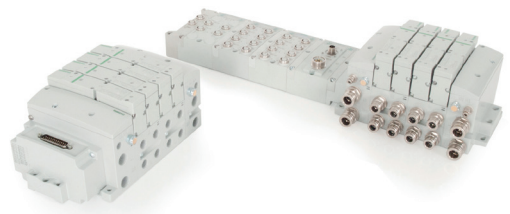

function	type	symbol  pilot (14) return (12)	rated flow		response time open / closed  (ms)	pilot pressure at 23°C (bar)		operating pressure port 1			
			at 6,3 bar ΔP 1 bar l/min (ANR)			min.	max.	min.	max. (PS)		
			1 → 2 3 → 4	2 → 3 4 → 5	air (*)				=		
<b>SPOOL VALVE, RUBBER PACKED TECHNOLOGY, WITH IMPULSE MANUAL OPERATOR</b>											
2 x 3/2 NC	K	 spring	High flow subbase	1000	800	15 / 20	3,5 (a)	8	2	8	R503A2BD0MA00F1
			ISO subbase	900	800						
2 x 3/2 NO	N	 spring	High flow subbase	950	950	15 / 20	3,5 (a)	8	2	8	R503A2BA0MA00F1
			ISO subbase	900	900						
5/2	S	 spring	High flow subbase	1400	1300	20 / 60	2	8	-0,95	8	R503A2B10MA00F1
			ISO subbase	1200	1100						
	M	 differential return	High flow subbase	1400	1300	28 / 40	3	8	-0,95	8	R503A2BN0MA00F1
			ISO subbase	1200	1100						
J	 solenoid air	High flow subbase	1400	1300	20 / 20	2	8	-0,95	8	R503A2B40MA00F1	
		ISO subbase	1200	1100							
5/3	G	 W1 closed centre position	High flow subbase	1400	1300	15 / 20	4	8	-0,95	8	R503A2B60MA00F1
			ISO subbase	1200	1100						
	B	 W2 centre open to pressure	High flow subbase	1300	600	18 / 45	3	8	-0,95	8	R503A2B70MA00F1
			ISO subbase	1100	600						
	E	 W3 centre open to exhaust	High flow subbase	600	1300	18 / 45	3	8	-0,95	8	R503A2B50MA00F1
			ISO subbase	600	1100						



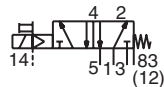

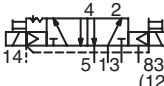
## SPECIFICATIONS

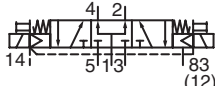
15-DIGIT PRODUCT CODE

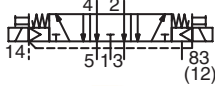
function	type	symbol  pilot (14) return (12)	rated flow		response time  open / closed	pilot pressure  at 23°C (bar)		operating pressure port 1			
			at 6,3 bar ΔP 1 bar l/min (ANR)			min.	max.	max. (PS) air (*)			
			1 → 2 1 → 4	2 → 3 4 → 5	=						
<b>SPOOL VALVE, SPOOL AND SLEEVE TECHNOLOGY, WITH IMPULSE MANUAL OPERATOR</b>											
5/2	S	 spring	High flow subbase	1200	1200	20 / 60	2	8	-0,95	8	R503A1B10MA00F1
			ISO subbase	1100	1000						
	J	 solenoid air	High flow subbase	1200	1200	15 / 15	2	8	-0,95	8	R503A1B40MA00F1
			ISO subbase	1100	1000						
5/3		 W2 centre open to pressure	High flow subbase	1000	1000	20 / 60	2	8	-0,95	8	R503A1B70MA00F1
			ISO subbase	800	800						
		 W3 centre open to exhaust	High flow subbase	1000	1000	20 / 60	2	8	-0,95	8	R503A1B50MA00F1
			ISO subbase	800	800						

(\*) Ensure that the compatibility of the fluids in contact with the materials is verified.

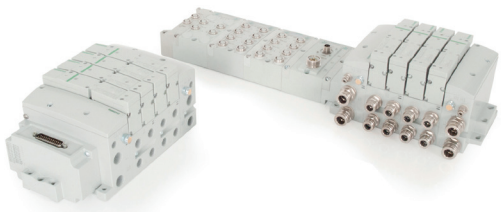

## Plug in Valve

### Dimensions (mm)

[Configurator - CAD Files](#)

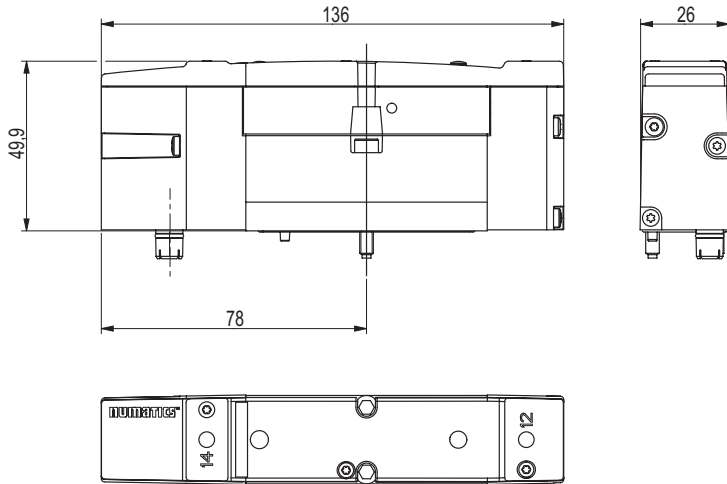

weight (kg)
0.236

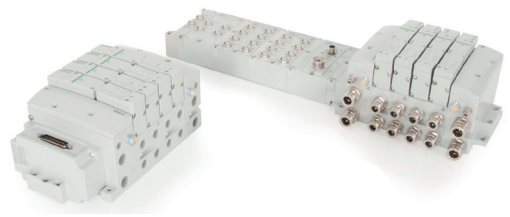

**Assembly kits**

**25 or 37 Pin Sub-D**

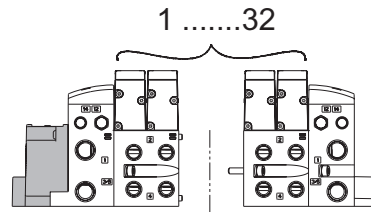

**1-32 Terminal Strip**

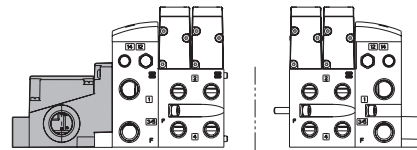

**19 Pin Round Connector**

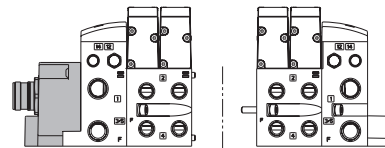

**26 Pin Round Connector**

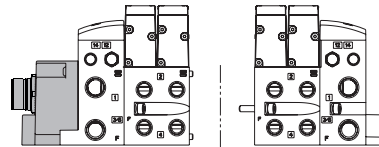

**Manifold assembly with G3 Electronics & Discrete I/O**

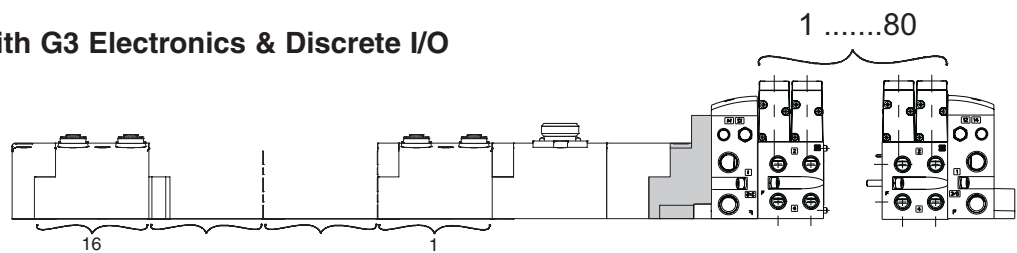

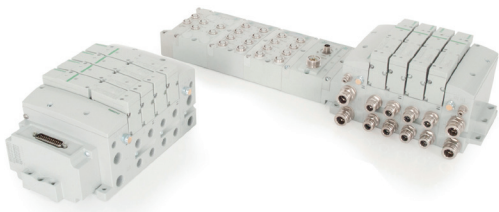

**503 series**

**How to Order - Manifold Assembly kit**

[Configurator - CAD Files](#)

15-DIGIT PRODUCT CODE											
	<b>G</b>	<b>503</b>	<b>A</b>	<b>V</b>	<b>3</b>	<b>2</b>	<b>3</b>	<b>0</b>	<b>0</b>	<b>V</b>	<b>A00</b>
<p><b>Thread connection</b>  <b>G</b> = ISO 228/1  <b>8</b> = NPT (contact us)  <b>K</b> = Push-in connectors</p> <p><b>Product series</b>  <b>503</b></p> <p><b>Revision letter</b>  <b>A</b> = Initial release</p> <p><b>Product type</b>  <b>V</b> = Valve Manifold Assembly</p> <p><b>Electronics</b>  <b>8</b> = 580 Fieldbus Electronics  <b>D</b> = CHARMS Electronics  <b>3</b> = G3 Fieldbus Electronics  <b>J</b> = 25 Pin Sub-D Connector  <b>M</b> = 37 Pin Sub-D Connector  <b>Q</b> = 19 Pin Round Connector  <b>R</b> = 26 Pin Round Connector  <b>T</b> = Terminal Strip 1-32  <b>Z</b> = Fanuc Robot End Effector  <b>0</b> = No Electronics</p> <p><b>Number of Valve Stations</b>  <b>B</b> = 2/34/66    <b>L</b> = 12/44/76    <b>V</b> = 22/54    <b>7</b> = 32/64  <b>D</b> = 4/36/68    <b>N</b> = 14/46/78    <b>X</b> = 24/56  <b>F</b> = 6/38/70    <b>P</b> = 16/48/80    <b>Z</b> = 26/58  <b>H</b> = 8/40/72    <b>R</b> = 18/50    <b>3</b> = 28/60  <b>J</b> = 10/42/74    <b>T</b> = 20/52    <b>5</b> = 30/62</p>										<p><b>Options</b>  <b>A00</b> = Standard (no options)  <b>MUF</b> = Muffler in End Plates  <b>DRM</b> = DIN Rail Mount  <b>DWM</b> = DIN Rail Mount with Muffler  <b>14X</b> = External pilot supply from port 14  <b>D12</b> = External pilot supply from port 14 and Muffler in End Plates  <b>D14</b> = External pilot supply from port 14 and DIN Rail Mount  <b>F06</b> = External pilot supply from port 14 Muffler in End Plates and DIN Rail Mount  <b>A27</b> = Fanuc Robot EE Connection Interface    <b>D28</b> = Fanuc Robot EE Connection + Muffler in End Plate</p> <p><b>End Plate Style</b>  <b>V</b> = Vertical  <b>C</b> = Combination</p> <p><b>Second Valve Series</b>  <b>0</b> = No Second Valve Series  <b>2</b> = 18 mm Valve</p> <p><b>Valve Station Adder</b>  <b>0</b> = No Adder  <b>1</b> = 32+  <b>2</b> = 64+</p> <p><b>End Plate Port Size</b>  <i>Used with the first digit «G» or «8»:</i>  <b>3</b> = 3/8 (manifold base)  <i>Used with the first digit «K»:</i>  <b>K</b> = 8 x 10 mm (push-in connector)  <b>M</b> = 10 x 12 mm (push-in connector)</p>	

**Maximum Solenoid Outputs**

Terminal Strip 1-32	25 Pin Sub-D Connector	37 Pin Sub-D Connector	19 Pin Round Connector	26 Pin Round Connector
32	22	32	16	22

\*Note: Maximum number of valve stations is determined by:

- The electrical connection type.
- The valve type: single and/or double solenoid valves

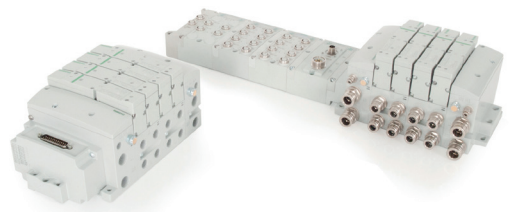

### How to Order - Manifold assemblies and subbase

[Configurator - CAD Files](#)

#### How to Order Subbases

#### 15-DIGIT PRODUCT CODE

**G 503 A M S2 2 M A00 1 0**

#### Thread connection

- G = ISO 228/1
- 8 = NPT (contact us)
- K = Push-in connectors

#### Product series

503 (26 mm valve)

#### Revision letter

A = Initial release

#### Product type

- M = Manifold base
- Z = Mid station supply
- F = 32+ Solenoid Manifold Subbase

#### Mounting

- S2 = Manifold base, 2 stations, side port, single Z-Board™
- M2 = Manifold base, 2 stations, side port, double Z-Board™
- M4 = 32+ Manifold Sub Base, 4 Stations, Side Ports, Double Z-Board™
- D2 = Manifold Sub Base, 2 Stations, Dual Flow, Side Ports, Double Z-Board™

#### Interface

- 1 = Pneumatic high flow
- 2 = ISO 15407-2 (26 mm)

#### Options

- A00 = Standard (internal pilot)
- 14X = External pilot supply from port 14
- 83H = Pilot Separation from Station 1
- 83J = Pilot Separation from Station 2

#### Wiring option

- M = Plug-in
- V = +24 V DC Separation at First Station
- W = +24 V DC Separation at Second Station
- X = 0 & +24 V DC Separation at First Station

T = 32+ Solenoid Auxiliary Power (used with M4 and F)

#### Port connection (2-4)

Used with the first digit «G» or «8»:

- 2 = 1/4
- 4 = 1/2 (Used for Dual Flow only)

Used with the first digit «K»:

- H = 6 x 8 mm [push-in connector only]
- K = 8 x 10 mm [push-in connector only]

### Dimensions (mm)

#### Plug in Valve Mounted

[Configurator - CAD Files](#)

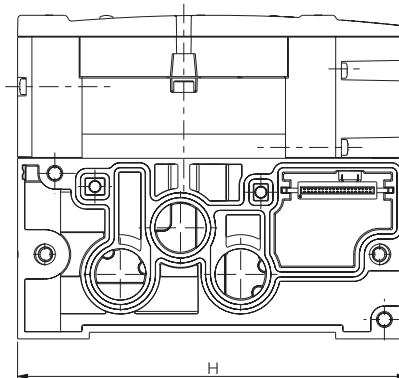
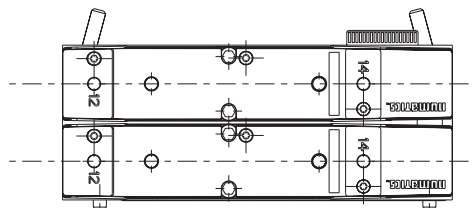
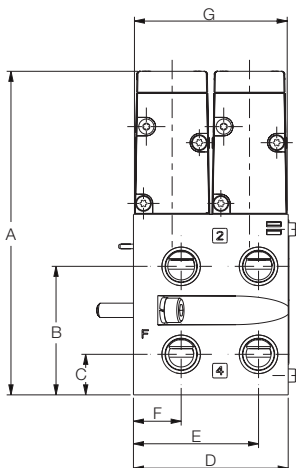

A	B	C	D	E	F	G	H
112.9	44.9	14.2	54	43.7	16.7	53.3	136

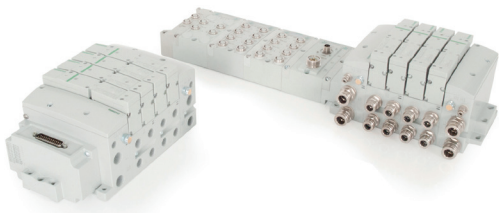

**503 series**

**How to Order - Valves**

[Configurator - CAD Files](#)

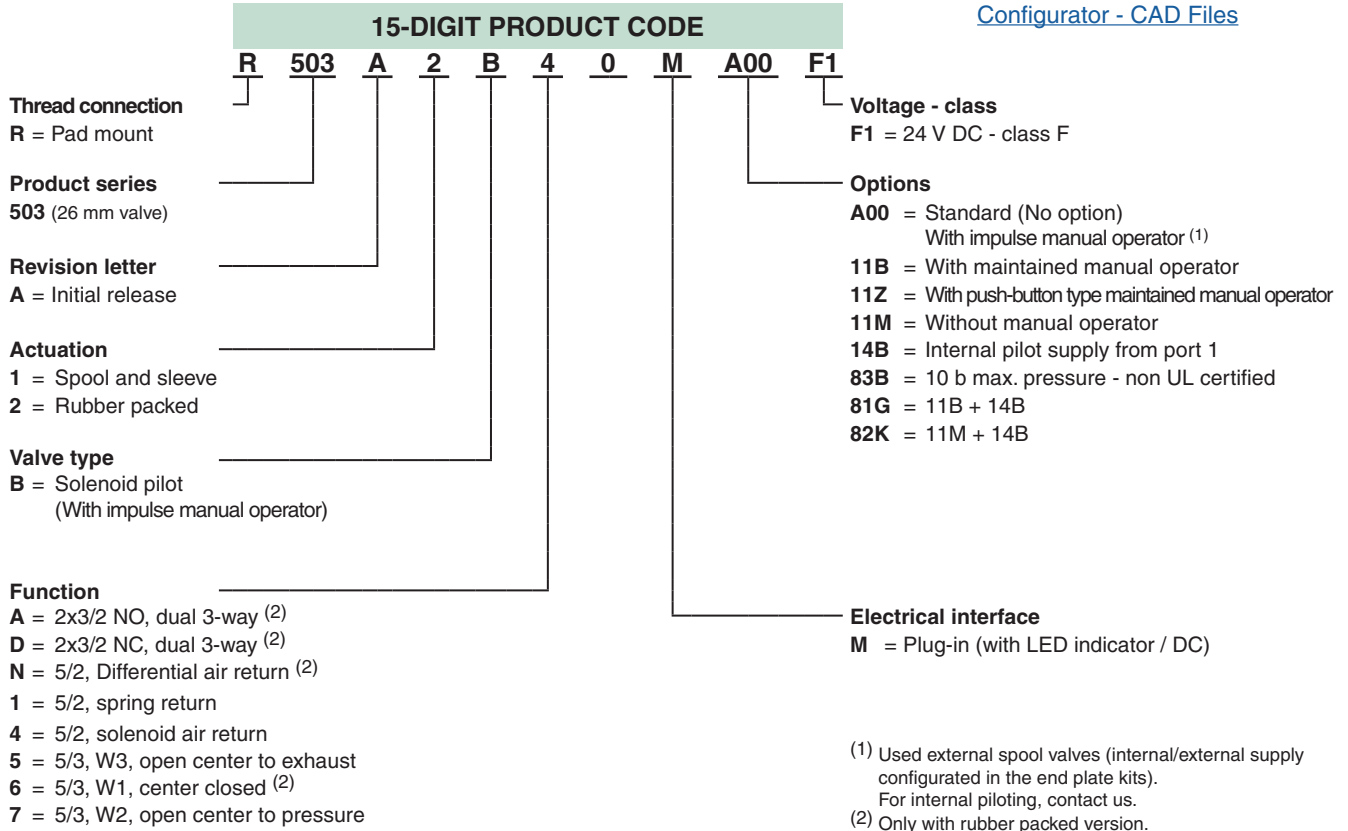

(1) Used external spool valves (internal/external supply configured in the end plate kits). For internal piloting, contact us.  
(2) Only with rubber packed version.

**How to Order - Regulators**

[Configurator - CAD Files](#)

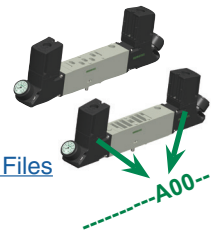
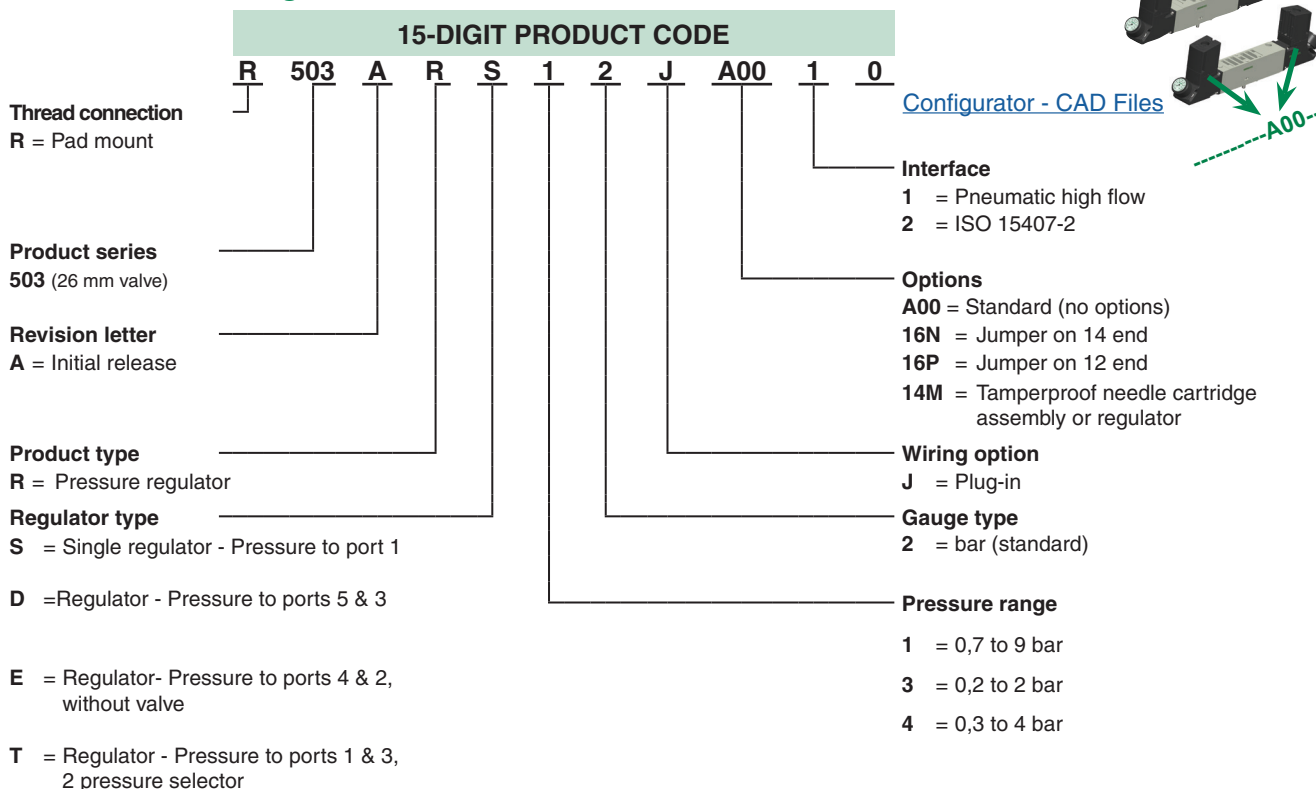



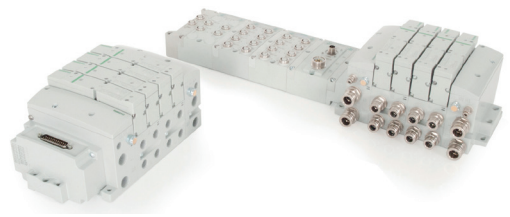

## How to Order - G3 Electronics

**G3 EP1 00 D 0 STD**

### Electronics Protocols

- CC1** = CC Link IE Field (1)
- CO1** = CANopen®
- DN1** = DeviceNet™
- EC1** = EtherCAT® (1)
- ED1** = EtherNET/IP™ DLR (1)
- EM1** = ModBus®/TCP (1)
- EP1** = EtherNet/IP™
- PL1** = POWERLINK (1)
- PT1** = PROFIBUS-DP® (1)
- PN1** = PROFINET® (1)
- DS2** = Backplane extension Valve Manifold (1)
- DS3** = Backplane extension I/O Assembly

### Number of I/O Modules

- 00** = 0
- 01** = 1
- 02** = 2
- 03** = 3
- 04** = 4
- 05** = 5
- 06** = 6
- 07** = 7
- 08** = 8
- 09** = 9
- 10** = 10
- 11** = 11
- 12** = 12
- 13** = 13
- 14** = 14
- 15** = 15
- 16** = 16

### Left Mounting

- D** = w/ Backplane extension Out
- H** = w/ Terminating Resistor

(1) 32+ capable.

### Special Options

- STD** = Standard
- DRM** = DIN Rail Mounting
- E23** = Fieldbus assembly without valves
- E28** = Valve Side 25 pin Sub D NPN output module
- E40** = Auto recovery Module (ARM)
- G32** = DRM-Din Rail Mounting E40-Auto Recovery Module (ARM)
- G33** = DRM-Din Rail Mounting E28-Valve Side 25 pin Sub D NPN output module
- G34** = E28-Valve Side 25 pin Sub D NPN output module E40-Auto Recovery Module (ARM)
- G36** = E23-Fieldbus assembly without valves DRM-Din Rail Mounting
- J32** = DRM-Din Rail Mounting E28-Valve Side 25 pin Sub D NPN output module E40-Auto Recovery Module (ARM)

### Modification

- 0** = Initial release

