

WLS15 High Intensity LED Strip Light

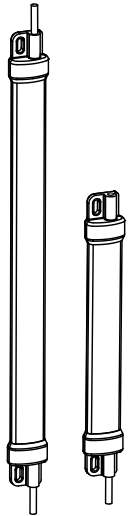

Instruction Manual



Banner's WLS15 High Intensity LED Strip Lights have sturdy aluminum inner frames, encased in shatter resistant, UV-stabilized, polycarbonate shells, making them ideal for indoor and outdoor applications.

- Low-profile, space-saving design
- Rugged, water-resistant design
- Available in four lengths from 360 mm to 1200 mm
- Daisy chain power to multiple lights
- Optional snap clips for easy installation and repositioning
- Capability to dim lights using the wiring pinout (Hi/Lo/Off)

These Work Light Strips are available as either stand-alone models, or as cascade models that can be daisy-chained together for longer lighting runs, with a minimum of wiring.

Stand-alone models have one end for power connection and no connections at opposite end. A stand-alone model may be used as the last in the cascade series.

Cascade models have one end for power connection, and a connection at the opposite end for connecting to other lights in the cascade. A double-ended accessory cordset may be used between each pair of lights in a cascade to extend the distance between lights.



For PWM dimming, use with the LC15T-127AP2RBGQP dimmer module. For more information, refer to the LC15T In-Line Touch Switch datasheet, p/n [217460](#).



Important: Read the following instructions before operating the light. Please download the complete WLS15 High Intensity LED Strip Light technical documentation, available in multiple languages, from www.bannerengineering.com for details on the proper use, applications, Warnings, and installation instructions of this device.



Important: Lea el siguiente instructivo antes de operar el luminario. Por favor descargue desde www.bannerengineering.com toda la documentación técnica de los WLS15 High Intensity LED Strip Light, disponibles en múltiples idiomas, para detalles del uso adecuado, aplicaciones, advertencias, y las instrucciones de instalación de estos dispositivos.



Important: Lisez les instructions suivantes avant d'utiliser le luminaire. Veuillez télécharger la documentation technique complète des WLS15 High Intensity LED Strip Light sur notre site www.bannerengineering.com pour les détails sur leur utilisation correcte, les applications, les notes de sécurité et les instructions de montage.

Models

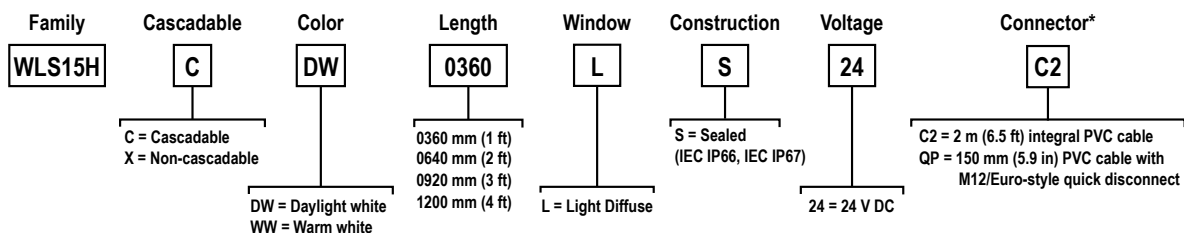

*Models with a quick disconnect require a mating cordset

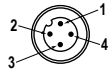
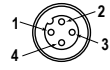

Wiring

Pinout (Male)	Pinout (Female)	Pin	Wire Color	Connection
		1	brown	24 V DC
		3	blue	DC common
		4	black	Connect to 24 V DC for 50% of maximum intensity. For 100% maximum intensity, leave the black wire floating or connected to common
		2	white	Not used

Specifications

Supply Protection Circuitry

Protected against reverse polarity and transient voltages
See electrical characteristics on product label

Supply Voltage

24 V DC (+20%/-10%)
Use only with a suitable Class 2 power supply (UL) or a SELV power supply (CE)

Spacing Criterion

Vertical: 1.26
Horizontal: 1.26

Supply Current

Light Length	Typical Current (A) at 25°C ¹	Max. Current (A) at -40°C
0360 mm	0.285	0.360
0640 mm	0.570	0.720
0920 mm	0.855	1.080
1200 mm	1.140	1.440

Operating Temperature

-40 °C to +50 °C (-40 °F to +122 °F)

Storage Temperature

-40 °C to +70 °C (-40 °F to +158 °F)

Environmental Rating

Rated IEC IP66 and IEC IP67
Suitable for wet locations per UL 2108

Vibration and Mechanical Shock

Vibration: 10 Hz to 55 Hz, 1.0 mm peak-to-peak amplitude per IEC 60068-2-6
Shock: 15G 11 ms duration, half sine wave per IEC 60068-2-27

Construction

Clear anodized aluminum housing; Polycarbonate outer housing, Polyamide end caps

Application Note

When connecting cascading lights in series, it is important not to exceed maximum current limitations:

- Maximum length of light at 24 V DC: 3.0 m (9.8 ft)
- At 50% intensity, double the lengths

Connections

2 m (6.5 ft) integral PVC cable or 150 mm (6 in) PVC cable with a 4-pin M12/ Euro-style male quick disconnect
Models with a quick disconnect require a mating cordset
Do not spray cable with high-pressure sprayer or cable damage will result.

LED Lifetime

Lumen Maintenance - L70
When operating within specifications, output will decrease less than 30% after 70,000 hours.

Certifications



Mounting

Integral mounting slots for M4 (#8) screws, tighten to 5 in-lbf max torque
Multiple bracket options available
Secure cables within 150 mm (5.9 inches) of the light



Note: For 920 mm and 1200 mm models in environments that vary more than 10 °C (18 °F), it is recommended to use one of the mounting bracket options instead of the endcap slots. If using the LMBWLS15 clip bracket and additional attachment is desired, only one end may be fastened using one of the spacers provided in the LMBWLS15 hardware packet to allow the opposite end to expand and contract. See [Mounting Accessories](#) on p. 5 for bracket and tape options that allow expansion and contraction over temperature variations.

Light Characteristics

Daylight White Efficacy: 110 lumens/watt typical at 24 V DC at 25 °C (77 °F)
CRI: 80, minimum

Color	Dominant Wavelength (nm) or Color Temperature	Lighted Length Lumens (Typical at 25°C) ¹			
		360 mm	640 mm	920 mm	1200 mm
Daylight White	5000K (±300K)	750	1500	2250	3000
Warm White	3000K (±200K, -100K)	700	1400	2100	2800

¹ Values shown at 25°C - current and lumen values decrease 0.4% per 1°C from ambient. For example, a 1200 mm unit will have a maximum current of 1.440 A at -40°C and 1.026 A at +50°C.

Dimensions

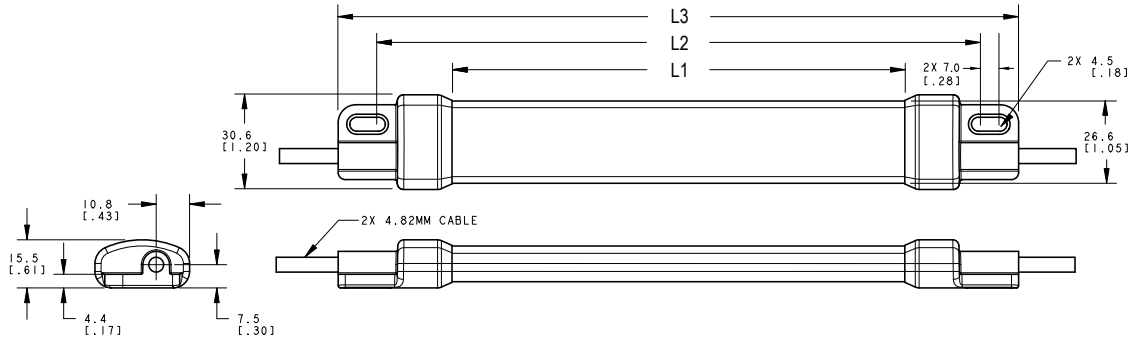

Models	L1	L2	L3
WLS15..0360..	286.4 mm (11.28 inches)	334 mm (13.15 inches)	360 mm (14.17 inches)
WLS15..0640..	566.4 mm (22.3 inches)	614 mm (24.17 inches)	640 mm (25.2 inches)
WLS15..0920..	846.4 mm (33.32 inches)	894 mm (35.2 inches)	920 mm (36.22 inches)
WLS15..1200..	1126.4 mm (44.35 inches)	1174 mm (46.22 inches)	1200 mm (47.24 inches)

Performance Curves

Optical data shown below is for daylight white only. To get lux and candela values for warm white multiply the values shown on the charts by 0.933.

Figure 1. 360 mm Models

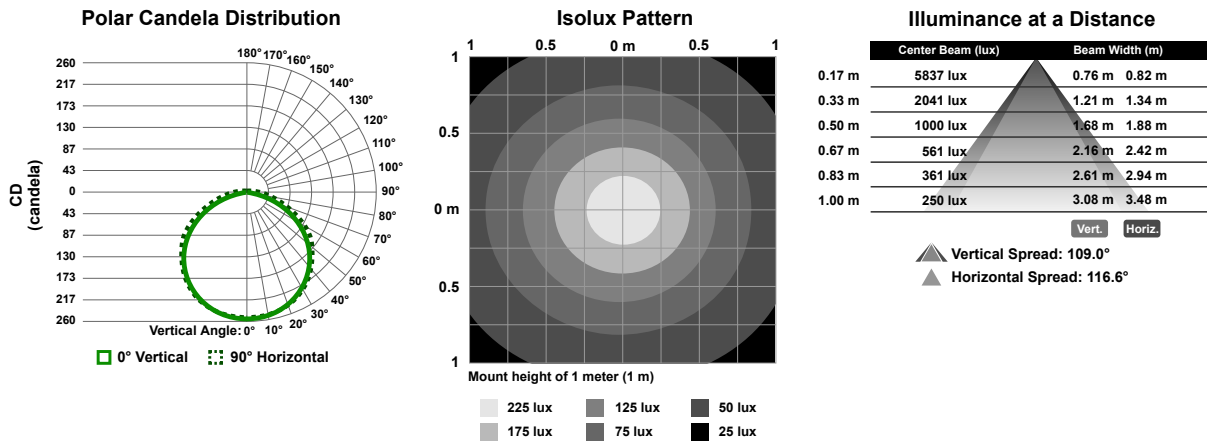

Figure 2. 640 mm Models

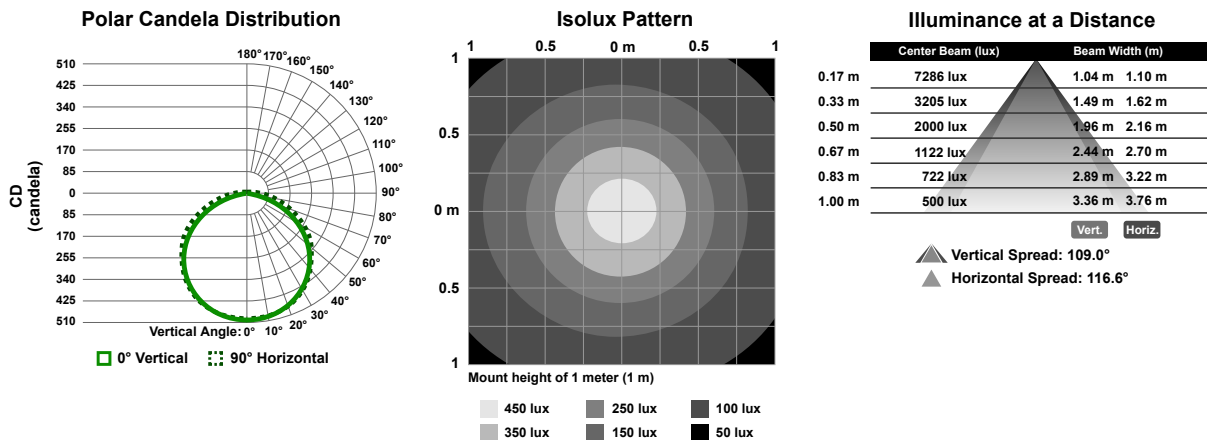

Figure 3. 920 mm Models

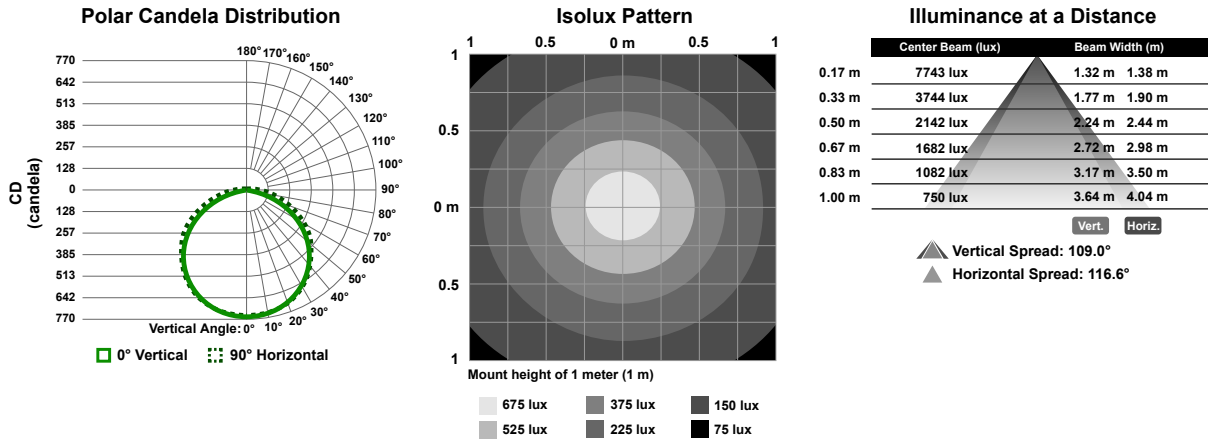
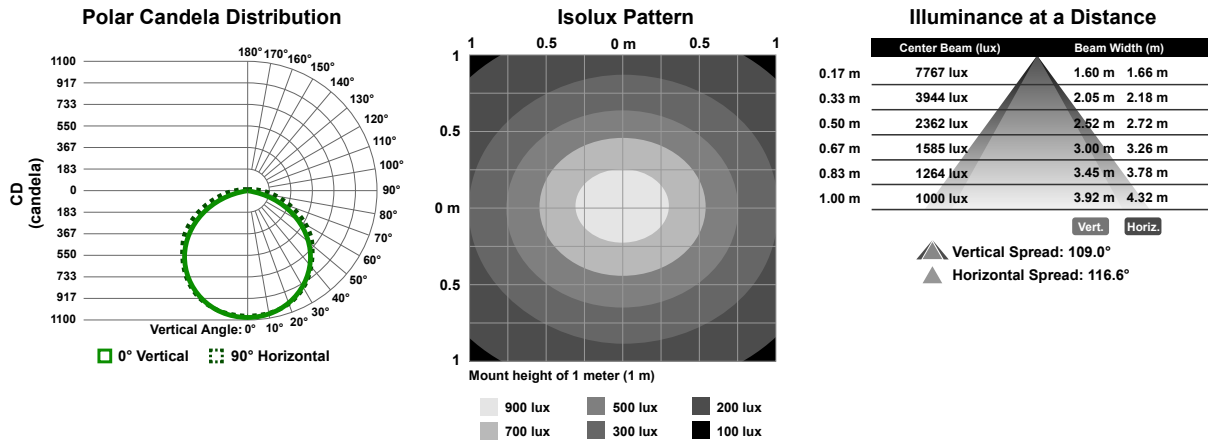

Figure 4. 1200 mm Models



Accessories

Cordsets

Use single-ended cordsets between the power source and the quick-disconnect connection of a stand-alone light or the first light in a cascade. Use double-ended cordsets between lights in a cascade.

4-Pin Threaded M12/Euro-Style Cordsets—Single Ended				
Model	Length	Style	Dimensions	Pinout (Female)
MQDC-406	2 m (6.56 ft)	Straight		<p>1 = Brown 2 = White 3 = Blue 4 = Black</p>
MQDC-415	5 m (16.4 ft)			
MQDC-430	9 m (29.5 ft)			
MQDC-450	15 m (49.2 ft)	Right-Angle		
MQDC-406RA	2 m (6.56 ft)			
MQDC-415RA	5 m (16.4 ft)			
MQDC-430RA	9 m (29.5 ft)			
MQDC-450RA	15 m (49.2 ft)			

4-Pin Threaded M12/Euro-Style Cordsets—Double Ended				
Model	Length	Style	Dimensions	Pinout
MQDEC-401SS	0.31 m (1 ft)	Male Straight/ Female Straight		Female
MQDEC-403SS	0.91 m (2.99 ft)			
MQDEC-406SS	1.83 m (6 ft)			Male
MQDEC-412SS	3.66 m (12 ft)			
MQDEC-420SS	6.10 m (20 ft)			
MQDEC-430SS	9.14 m (30.2 ft)			
MQDEC-450SS	15.2 m (49.9 ft)			
				1 = Brown 2 = White 3 = Blue 4 = Black

4-Pin Threaded M12/Euro-Style Splitter Cordsets—Flat Junction			
Model	Branches (Female)	Trunk (Male)	Pinout
CSB-M1240M1240	No branch	No trunk	Female Male 1 = Brown 2 = White 3 = Blue 4 = Black
CSB-M1240M1241	2 x 0.3 m (1 ft)	No trunk	
CSB-M1241M1241		0.30 m (1 ft)	
CSB-M1248M1241		2.44 m (8 ft)	
CSB-M12415M1241		4.57 m (15 ft)	
CSB-M12425M1241		7.60 m (25 ft)	
CSB-UNT425M1241		7.60 m (25.0 ft) unterminated	

Mounting Accessories

LMBWLS15

- Stainless steel clip bracket
- Includes 3 clip brackets and 2 plastic spacers
- Clearance hole for M5 hardware

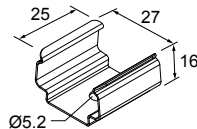

LMBWLS15-150S

- Set of 2 stainless steel swivel bracket, allows for 150° of movement
- Clearance hole for M5 button head screw

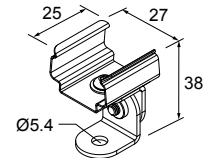

LMBWLS15MAG

- Set of 2 brackets
- Magnetic mounting bracket for attachment to steel and iron surfaces

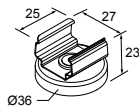

LMBWLS15TD

- Includes 4 100 mm (4 in) strips of 3M™ Dual Lock™ reclosable fasteners
- Recommended for mounting to metal and plastic surfaces
- Strong, pressure-sensitive adhesive bonds on contact



LMBWLS15TF

- Includes 2 100 mm (4 in) strips of double-sided foam urethane strips
- Acrylic adhesive provides high bond strength to most surfaces
- Bonds to low surface energy plastics such as polypropylene and powder coated paints

**ACC-CAP Euro-10**

- 10 Caps
- Seal and protect exposed, unterminated cascade quick disconnect connectors



All measurements are listed in millimeters [inches], unless noted otherwise.

Power Supplies

PSD-24-4

- 90 to 264 V AC 50/60 Hz input
- Includes a 1.8 m (6 ft) US style 5-15P input plug
- 24 V DC UL Listed Class 2 M12/Euro-style connector output
- 4 A total current



For use with cascades of lights that do not exceed a total maximum operating current of 4A (refer to maximum current specifications).

PSW-24-1

- 24 V DC, 1 A Class 2 UL Listed power supply
- 100 V AC to 240 V AC 50/60 Hz input
- 2 m (6.5 ft) PVC cable with M12/Euro-style quick disconnect
- Includes Type A (US, Canada, Japan, Puerto Rico, Taiwan), Type C (Germany, France, South Korea, Netherlands, Poland, Spain, Turkey), Type G (United Kingdom, Ireland, Singapore, Vietnam), and Type I (China, Australia, New Zealand) AC detachable input plugs



For use with all non-cascaded lights or cascades of lights that do not exceed a total maximum operating current of 1A (refer to maximum current specifications).

Banner Engineering Corp. Limited Warranty

Banner Engineering Corp. warrants its products to be free from defects in material and workmanship for one year following the date of shipment. Banner Engineering Corp. will repair or replace, free of charge, any product of its manufacture which, at the time it is returned to the factory, is found to have been defective during the warranty period. This warranty does not cover damage or liability for misuse, abuse, or the improper application or installation of the Banner product.

THIS LIMITED WARRANTY IS EXCLUSIVE AND IN LIEU OF ALL OTHER WARRANTIES WHETHER EXPRESS OR IMPLIED (INCLUDING, WITHOUT LIMITATION, ANY WARRANTY OF MERCHANTABILITY OR FITNESS FOR A PARTICULAR PURPOSE), AND WHETHER ARISING UNDER COURSE OF PERFORMANCE, COURSE OF DEALING OR TRADE USAGE.

This Warranty is exclusive and limited to repair or, at the discretion of Banner Engineering Corp., replacement. **IN NO EVENT SHALL BANNER ENGINEERING CORP. BE LIABLE TO BUYER OR ANY OTHER PERSON OR ENTITY FOR ANY EXTRA COSTS, EXPENSES, LOSSES, LOSS OF PROFITS, OR ANY INCIDENTAL, CONSEQUENTIAL OR SPECIAL DAMAGES RESULTING FROM ANY PRODUCT DEFECT OR FROM THE USE OR INABILITY TO USE THE PRODUCT, WHETHER ARISING IN CONTRACT OR WARRANTY, STATUTE, TORT, STRICT LIABILITY, NEGLIGENCE, OR OTHERWISE.**

Banner Engineering Corp. reserves the right to change, modify or improve the design of the product without assuming any obligations or liabilities relating to any product previously manufactured by Banner Engineering Corp. Any misuse, abuse, or improper application or installation of this product or use of the product for personal protection applications when the product is identified as not intended for such purposes will void the product warranty. Any modifications to this product without prior express approval by Banner Engineering Corp will void the product warranties. All specifications published in this document are subject to change; Banner reserves the right to modify product specifications or update documentation at any time. Specifications and product information in English supersede that which is provided in any other language. For the most recent version of any documentation, refer to: www.bannerengineering.com.

For patent information, see www.bannerengineering.com/patents.

Mexican Importer

Banner Engineering de México, S. de R.L. de C.V.
David Alfaro Siqueiros 103 Piso 2 Valle oriente
San Pedro Garza García Nuevo León, C. P. 66269
81 8363.2714