

# NUMATICS®

## AG Series

Angular Grippers

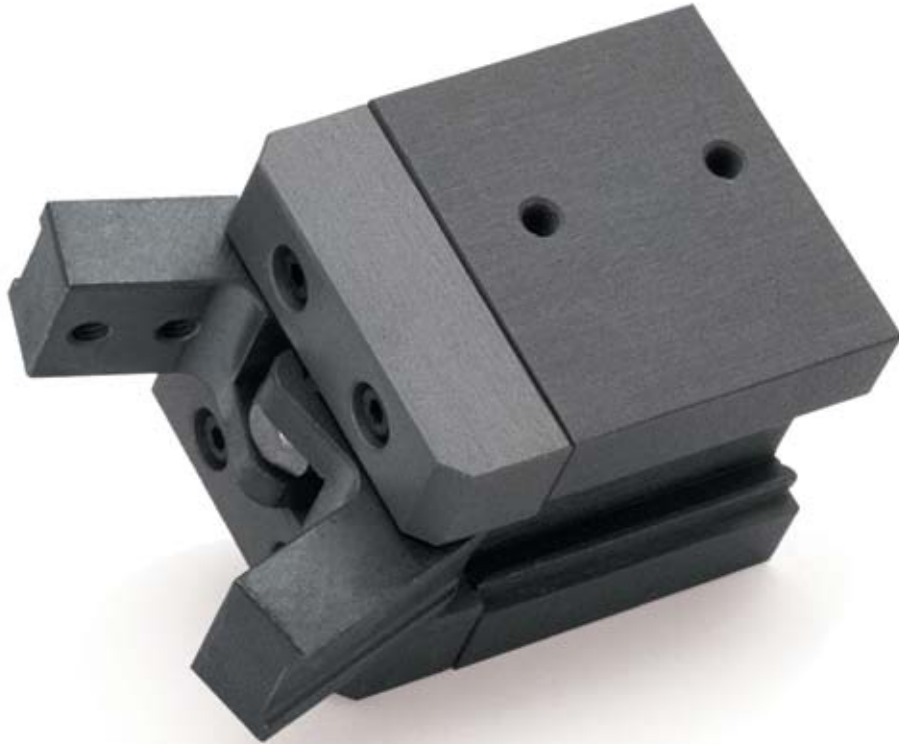

[www.numatics.com](http://www.numatics.com)

## **AG Series Angular Grippers**

Features and Benefits	3
How to Order	4
Dimensions	5
Specifications and Load Ratings	6
Sensing Part Numbers	7
Quick Disconnect Cables	8

### AG-Series Angular Grippers

#### Designed to handle real world angular gripper applications

The Numatics Motion Control AG-Series Angular Gripper utilizes a double acting piston with a dual pivot system. The piston has a single center pivot that drives each gripper jaw open and closed. The gripper jaws have an independent stationary pivot which each jaw arcs about. The ratio between the piston and jaw pivots has been optimized for maximum operating performance.

The Numatics Motion Control AG-Series Angular Gripper is a cartridge style design. The cartridge design utilizes a minimum number of components, seven major components in all. The cartridge design offers the greatest grip force to size ratio over other conventional designs.

#### A. Body:

- Cartridge design produced from extruded alloy aluminum.
- Hardcoat anodized with PTFE, reduced friction, reduced wear
- High finish bores for increased seal life
- Sensor mounting rail for easy access mounting (not available on AG010)
- Light weight, durable, long life

#### B. Piston:

- Single piece, stainless steel design
- Corrosion resistant
- Magnetic sensing band standard on ALL sizes

#### C. Jaws:

- Hardened alloy steel with lubrication
- Keyway slot for tooling location
- 32 degree jaw motion
- Each jaw travels 1 degree beyond center

#### D. Pivot Pins:

- Hardened alloy steel
- Reduced friction, low wear, increased service life
- Supported by polymer bushings

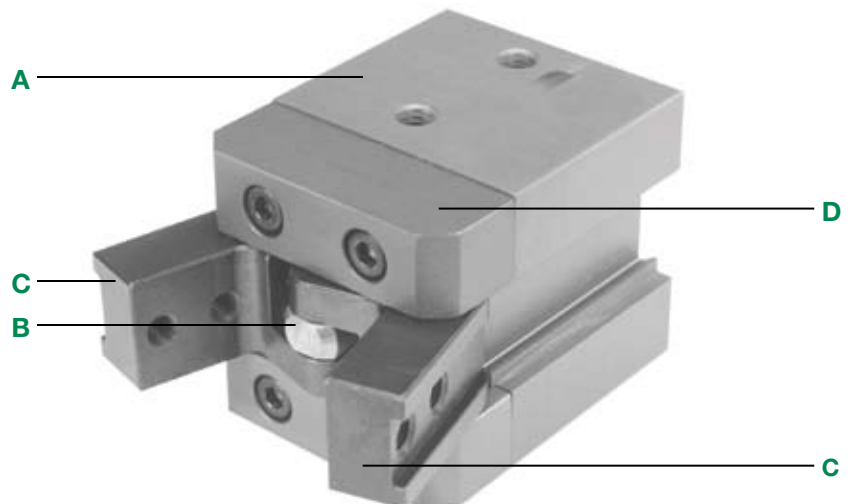

**How to Order**

**AG 010 A 1 6 D 1**

**Gripper Series**

- 010 = 9 lbs.
- 020 = 22 lbs.
- 010 = 35 lbs.

**Seal Type**

- 1 = Buna-N Seals
- 2 = FKM Seals

**Example order:**

**Part Number: AG020A13A1\***

Part Description: 22 pound grip force angular gripper, buna-n seals, reed switch open position, no option.

\*When ordering, DO NOT use spaces or dashes.

**Options**

- 1 = No Options
- 2 = Air Close/Spring Open
- 8\* = 90 Degree Fittings installed
- 9\* = Straight Fittings installed
- \*1/8 Diameter tube push-in

**Sensing Position**

- A\* = Single Position Open
- D = No Sensing
- \*AG20 & AG35 available only with "A" option single position open

**Sensing Type**

- Standard Cord Set
- 3 = Reed Switch
- 6 = No Sensing
- Quick Disconnect Cord Set
- X = Reed Switch
- See Sensor section.

**When ordering additional seal kits:**

Seal Kit Series	Buna Seal Kit	FKM Seal Kit
AG010A	AGSKB-010A	AGSKV-010A
AG020A	AGSKB-020A	AGSKV-020A
AG035A	AGSKB-035A	AGSKV-035

**When ordering additional switches:**

Switch Description	Standard Part No.	Quick Disconnect Part No.
Reed Switch	REED-FL2-00	REED-QDS-M8U
90° 5 meter cable	-	PXC90
Straight 5 meter cable	-	PXCST

**Dimensions: Inches (mm)**

### AG Series Dimensions

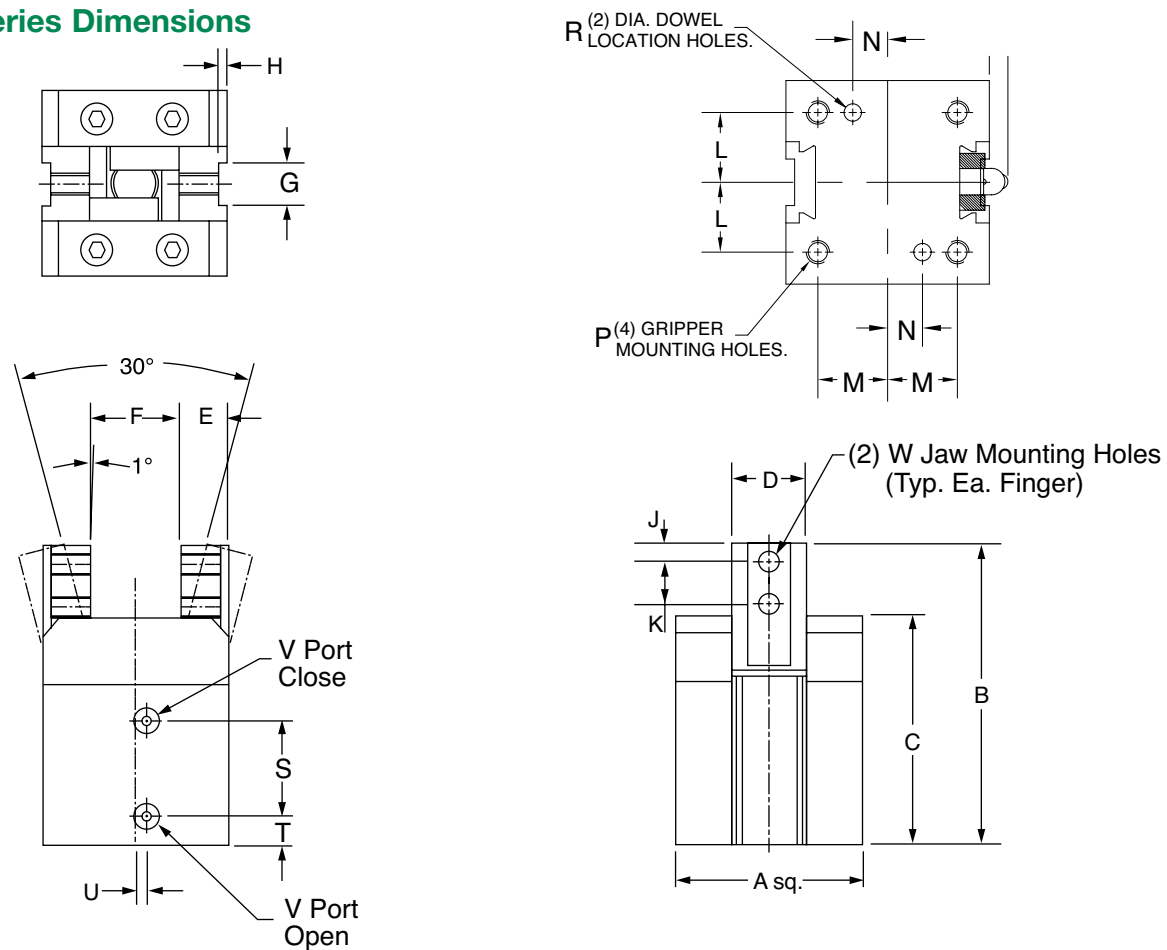

	AG010A		AG020A		AG035A	
A	0.78	(20.0)	1.10	(28.0)	1.38	(35.0)
B	1.35	(34.4)	1.83	(46.5)	2.24	(57.0)
C	1.06	(27.0)	1.38	(35.1)	1.70	(43.3)
D	0.28	(7.0)	0.43	(11.0)	0.55	(14.0)
E	0.20	(5.0)	0.27	(7.0)	0.35	(9.0)
F	0.39	(10.0)	0.55	(14.0)	0.67	(17.0)
G	0.16	(4.0)	0.27	(7.0)	0.31	(8.0)
H	0.03	(0.8)	0.04	(1.0)	0.06	(1.5)
J	0.08	(2.0)	0.12	(3.0)	0.14	(3.5)
K	0.16	(4.0)	0.23	(6.0)	0.31	(8.0)
L	0.26	(6.5)	0.37	(9.5)	0.47	(12.0)
M	0.26	(6.5)	0.37	(9.5)	0.47	(12.0)
N	.098	(2.50)	0.197	(5.00)	0.236	(6.00)
P	M3x0.5		M3x0.5		M4x0.7	
R	0.079	(2.0)	0.118	(3.0)	0.118	(3.0)
S	0.42	(10.7)	0.57	(14.4)	0.71	(18.1)
T	0.13	(3.2)	0.18	(4.7)	0.23	(6.0)
U	0.08	(2.0)	0.08	(2.0)	0.08	(2.0)
V	M3		M3		M5	
W	M2x0.4		M3x0.5		M4x0.7	

**AG-Series Gripper Performance Data**

	AG010A		AG020A		AG035A	
Grip Force						
open @ 100 psi	11 lbs	5 kgf	28 lbs	12.5 kgf	44 lbs	20 kgf
close @ 100 psi	9 lbs	4 kgf	22 lbs	10 kgf	35 lbs	16 kgf
Jaw Travel	32 degrees		32 degrees		32 degrees	
Weight	1.3 oz.	.04 kg	5.0 oz.	.14 kg	6.3 oz	.18 kg
Max Operating Pressure	250 psi		250 psi		250 psi	
Displacement	.01 cuin	.16cm	.04 cuin	.57cm	.06 cuin	1.1cm
Temp Range Buna Seals	-30 F to 180 F	-34 C to 82 C	-30 F to 180 F	-34 C to 82 C	-30 F to 180 F	-34 C to 82 C
Temp Range FKM Seals	-25 F to 400 F	-31 C to 204 C	-25 F to 400 F	-31 C to 204 C	-25 F to 400 F	-31 C to 204 C

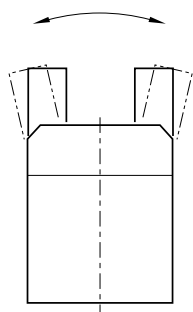

**Position A**

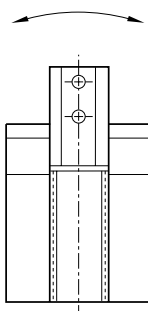

**Position B**

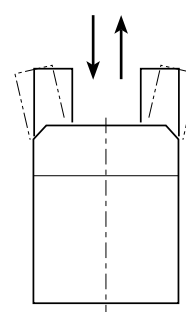

**Position C**

**Recommended Maximum Load Ratings**

	AG010A		AG020A		AG035A	
Max Load Position A	4 inlb	.45 Nm	15 inlb	1.7 Nm	30 inlb	3.4 Nm
Max Load Position B	4 inlb	.45 Nm	12 inlb	1.4 Nm	25 inlb	2.8 Nm
Max Load Position C	12 lbs	5.5 Kgf	29 lbs	13 Kgf	47 lbs	21 Kgf

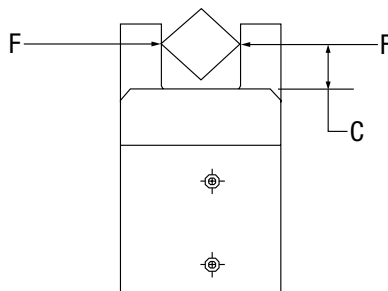

**Grip Force VS. Finger Length**

	Grip Force (lbs)		Grip Force (Newtons)	
AG010	$F = \frac{(0.024) \times (P)}{(C+0.126)}$	$P = \text{psi}, C = \text{in}$	$F = \frac{(39.328) \times (P)}{(C+3.200)}$	$P = \text{bars}, C = \text{mm}$
AG020	$F = \frac{(0.088) \times (P)}{(C+0.167)}$	$P = \text{psi}, C = \text{in}$	$F = \frac{(144.207) \times (P)}{(C+4.242)}$	$P = \text{bars}, C = \text{mm}$
AG035	$F = \frac{(0.175) \times (P)}{(C+0.233)}$	$P = \text{psi}, C = \text{in}$	$F = \frac{(286.771) \times (P)}{(C+5.918)}$	$P = \text{bars}, C = \text{mm}$

Example AG020: Operating Pressure => P=80 psi, Grip Distance => C=0.75 in  
 Grip Force (lbs) =  $\{(0.088) \times (80 \text{ psi})\} / \{0.75 \text{ (in)} + 0.167\} = 7.04/0.917 = 7.68 \text{ lbs}$

## Sensing Part Numbers

### REED-FL2-00

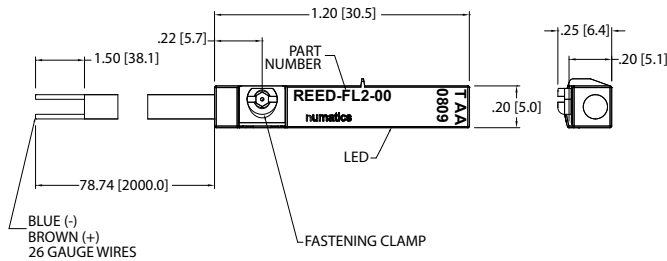

### REED-QDS-M8U

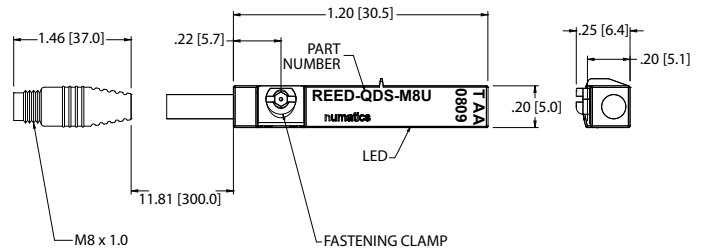

ELECTRICAL DESIGN	AC/DC REED
OUTPUT	Normally Open
OPERATING VOLTAGE	5-120 VAC/DC
CURRENT RATING	100 mA*
SHORT-CIRCUIT PROTECTION	No
OVERLOAD PROTECTION	No
REVERSE POLARITY PROTECTION	Yes
VOLTAGE DROP	< 5 V
REPEATABILITY	± .2mm
MAKETIME INCLUDING BOUNCE	< .6 ms
BREAKTIME	< .1 ms
SWITCHING POWER (MAX)	5 W
SWITCH FREQUENCY	1000 Hz
AMBIENT TEMPERATURE	-25°C to 70°C
PROTECTION	IP 67, II
HYSTERESIS	.9mm
HOUSING MATERIAL	PA (Polyamide) Black; Fastening Clamp: Stainless Steel
FUNCTION DISPLAY SWITCHING STATUS	Yellow LED
CONNECTION	Flying Leads, Pur Cable (2m Long, 2 x26 Gauge Wire)
REMARKS	*External Protective Circuit for Inductive Load (Valve, Contactor, Etc..) Necessary. Conforms to 2008 NEC Section 725 III, Class 2 Circuits  Clamping Screw with Combined Slot/Hexagon Socket Head AF 1.5. No LED Function in case of Polarity in DC Operation
ACCESSORIES	Rubber Placeholder, Cable Clip, and Cut Sheet To Be Provided with Every Switch
AGENCY APPROVALS	<b>CE RoHS</b>

ELECTRICAL DESIGN	AC/DC REED
OUTPUT	Normally Open
OPERATING VOLTAGE	*5-60 VDC / 5-50 VAC
CURRENT RATING	100 mA
SHORT-CIRCUIT PROTECTION	No
OVERLOAD PROTECTION	No
REVERSE POLARITY PROTECTION	Yes
VOLTAGE DROP	< 5 V
REPEATABILITY	± .2mm
MAKETIME INCLUDING BOUNCE	< .6 ms
BREAKTIME	< .1 ms
SWITCHING POWER (MAX)	5 W
SWITCH FREQUENCY	1000 Hz
AMBIENT TEMPERATURE	-25°C to 70°C
PROTECTION	IP 67, II
HYSTERESIS	.9mm
HOUSING MATERIAL	PA (Polyamide) Black; Fastening Clamp: Stainless Steel
FUNCTION DISPLAY SWITCHING STATUS	Yellow LED
CONNECTION	M8 Connector (Snap Fit), Pur Cable (.3m)
REMARKS	*External Protective Circuit for Inductive Load (Valve, Contactor, Etc..) Necessary. Conforms to 2008 NEC Section 725 III, Class 2 Circuits  M8 Connector voltage limited to 5-60 vdc / 5-50 vac to conform with 2008 IEC 61076-2-104  Clamping Screw with Combined Slot/Hexagon Socket Head AF 1.5. No LED Function in case of Polarity in DC Operation
ACCESSORIES	Rubber Placeholder, Cable Clip, and Cut Sheet To Be Provided with Every Switch
AGENCY APPROVALS	<b>CE RoHS</b>

\*Switches are not designed for wet environments. Please see your distributor for additional information.

**Quick Disconnect Cables**

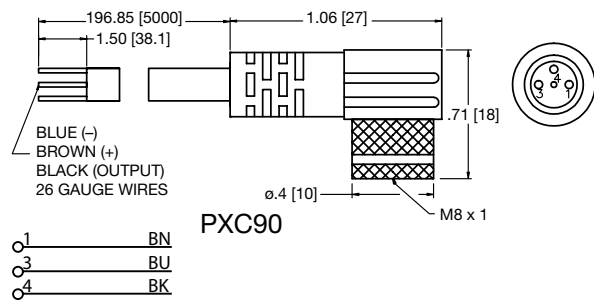
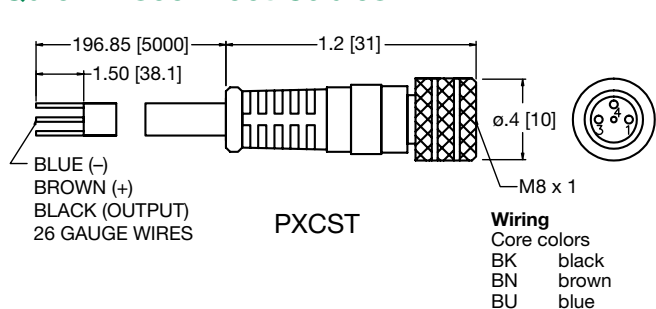

Order Code	Type	Operating Voltage	Current Rating	Cable Material	Protection	Connector
PXCST	Straight 5 m Cable (3 x 26 Gauge wire)	60 AC/75 DC	3 A	PUR	IP 68, III	M8
PXC90	90° 5 m Cable (3 x 26 Gauge wire)	60 AC/75 DC	3 A	PUR	IP 68, III	M8



# NUMATICS®

World Class Supplier of Pneumatic Components



## World Headquarters

### USA Numatics, Incorporated

46280 Dylan Drive  
Novi, Michigan 48377

P: 248-596-3200  
F: 248-596-3201

### Canada Numatics, Ltd

P: 519-758-2700  
F: 519-758-5540

### México - Ascomatica SA de CV

P: 52 55 58 09 56 40 (DF y Area metropolitana)  
P: 01 800 000 ASCO (2726) (Interior de la República)  
F: 52 55 58 09 56 60

### Brazil Ascoval Ind.e Comercio Ltda

P: (55) 11-4208-1700  
F: (55) 11-4195-3970