

For your safety, please read the following before using.

- ① Do not use corrosive or flammable gases or liquid with this product.
- ② Please use within the rated pressure range. Do not apply pressure beyond recommended maximum pressure, permanent damage to the pressure sensor may occur.
- ③ Do not drop, hit or allow excessive shock. Even if switch body appears undamaged, internal components may be broken and can cause malfunction.
- ④ Turn power off before connecting wiring. Incorrect wiring or short circuit will damage and / or cause malfunction.
- ⑤ Do not use in environment where steam or oil vapor is present.
- ⑥ This product is not explosion-proof rated. Do not use in atmospheres containing flammable or explosive gases.
- ⑦ Avoid wiring the sensor cable adjacent to or in the same cable tray with power or high voltage lines. Doing so could cause malfunction due to noise.
- ⑧ This product is not a safety sensor. Its use is not intended to protect life and prevent bodily injury or property damage from dangerous parts or machinery. It is a normal object detection sensor.

| SPECIFICATIONS | DPS280 (PRESSURE) | DVS280 (VACUUM) |
|--|--|--|
| Rated pressure range | 0 ~ 1000 kPa 0 ~ 145 PSIG | 0.0 ~ - 101.3 kPa 0 ~ 29.9" Hg Vacuum |
| Operating / Set pressure range | -100 ~ 1000 kPa - 14.5 PSIG ~ + 145 PSIG | 10.0 ~ - 101.3 kPa 1.45 PSIG ~ 29.9" Hg Vacuum |
| Maximum pressure (Exceeding max pressure could damage switch) | 1500 kPa 217.5 PSIG | 300 kPa 43.5 PSIG |
| Fluid | Air, Non-corrosive gases, incombustible gases | |
| Set pressure resolution | kPa | 1 |
| | kgf/cm ² | 0.01 |
| | bar | 0.01 |
| | psi | 0.1 |
| | InHg | - |
| | mmHg | 1 |
| Power supply voltage | 12 to 24VDC ± 10 %, Ripple (P-P) 10 % or less | |
| Current consumption | ≤ 45mA (with no load) | |
| Switch output | PNP open collector Max. load current: 125mA Max. supply voltage: 24VDC Residual voltage: 1.5V (load current 125mA) | NPN open collector Max. load current: 125mA Max. supply voltage: 30VDC Residual voltage: 1.5V (load current 125mA) |
| Repeatability (Switch output) | ± 0.2 % F.S. ± 1 digit | |
| Hysteresis mode | Adjustable | |
| Window comparator mode | | |
| Response time | ≤ 2.5ms (chatter-proof function: 24ms, 250ms, 500ms, 1000ms and 1500ms selections) | |
| Output short circuit protection | Yes | |
| 7 segment LCD display | Two color (red/green) display (sampling rate: 5 times/1sec.) | |
| Indicator accuracy | ± 2.0 % F.S. ± 1 digit (ambient temp: 77°F ± 5°F / 25°C ± 3°C) | |
| Switch ON Indicator | Green OUT Indicator | |
| Environment | Enclosure | IP40 |
| | Ambient temp. range | Operation: 0°F ~ 122°F / 0°C ~ 50°C, Storage: 14°F ~ 140°F / -10°C ~ 60°C (no condensation or freezing) |
| | Ambient humidity range | Operation/Storage: 35 ~ 85% RH (no condensation) |
| | Withstand voltage | 1000VAC in 1-min (between case and lead wire) |
| | Insulation resistance | 50Mohm min. (at 500 VDC, between case and lead wire) |
| | Vibration | Total amplitude 1.5mm, 10Hz-55Hz-10Hz scan for 1 minute, two hours each direction of X,Y and Z |
| | Shock | 100m/s ² (10G), 3 times each in direction of X,Y and Z |
| Temperature characteristic | ± 2% F.S. of detected pressure (77°F / 25°C) at temp. Range of 0°F ~ 122°F / 0°C ~ 50°C | |
| Port size | 1/8 NPT Male x 10-32 UNF Female, 1/8 PT x M5, G 1/8 x M5 | |
| Lead wire | Oil-resistant cable (0.15 mm ²) | |
| Weight | Approx 45g - Switch only Approx 90g - Switch with 2M mating cable | |

HOW TO ORDER

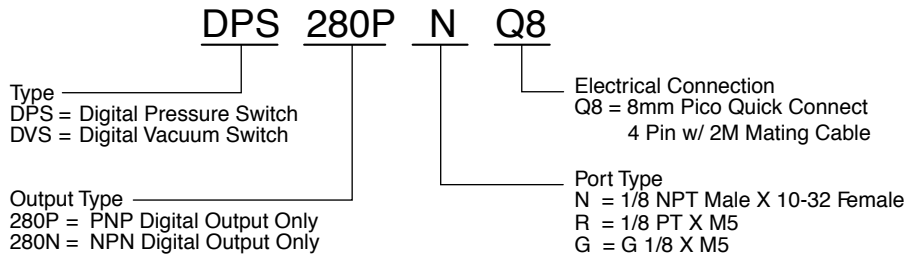

Example: DPS280PNQ8 = Digital Pressure Switch - PNP - 1/8 NPT - 8mm Pico 4 Pin w/ 2M Mating Cable

OUTPUT CIRCUIT WIRING

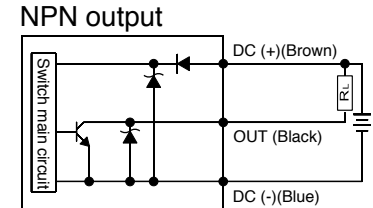
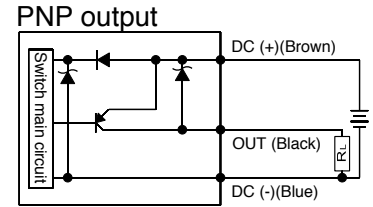

PANEL INSTRUCTIONS

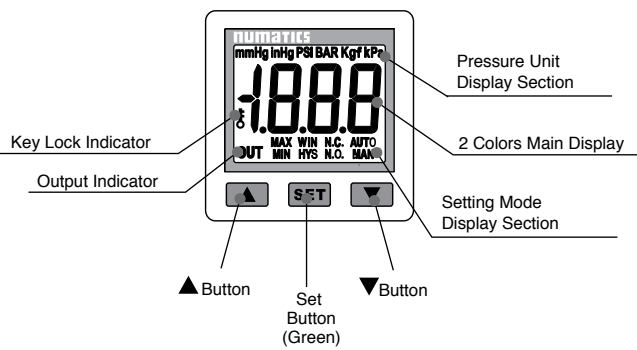

PINOUT

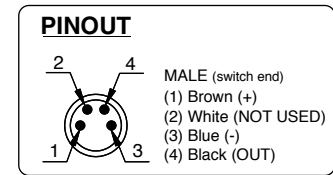

ERROR CODE INSTRUCTION

| Error Type | Error code | Error Condition | Troubleshooting |
|---------------------------|------------|---|--|
| Excess load current error | OLP | Output load current is more than 125 mA | Turn power off and check the cause of overload current or lower the current load under 125 mA, then restart. |
| Residual pressure error | OLr | During zero calibration, ambient pressure is over $\pm 3\%$ F.S. | Change input pressure to ambient pressure and perform zero calibration again. |
| Applied pressure error | HHH | Applied pressure exceeds the upper limit of the operating / set pressure range. | Adjust the pressure within operating pressure range. |
| | LLL | Applied pressure exceeds the lower limit of the operating / set pressure range. | |
| System Error | Er4 | Internal data error | Cycle power and restart. If error condition persists please contact factory for help. |
| | Er6 | Internal system error | |
| | Er7 | Internal data error | |
| | Er8 | Internal system error | |

PRESSURE UNIT CONVERSION TABLE

| To | Pa | kPa | MPa | kgf/cm ² | mmHg | psi | bar | inHg |
|-----------------------|----------|----------|-----------|---------------------|------------|-------------|-----------|-----------|
| | 1 | 0.001 | 0.000001 | 0.000010197 | 0.00750062 | 0.000145038 | 0.00001 | 0.0002593 |
| | 1000.000 | 1 | 0.001000 | 0.010197 | 7.500616 | 0.145038 | 0.010000 | 0.2953 |
| | 1000000 | 1000 | 1 | 10.197 | 7500.616 | 145.038 | 10 | 295.2998 |
| 1 kgf/cm ² | 98066.5 | 98.0665 | 0.0980665 | 1 | 735.559 | 14.2233 | 0.980665 | 28.95979 |
| 1 mmHg | 133.32 | 0.13332 | 0.000133 | 0.0013595 | 1 | 0.019336 | 0.0013332 | 0.039370 |
| | 6895 | 6.895 | 0.006895 | 0.07031 | 51.7157 | 1 | 0.06895 | 2.036074 |
| | 100000.0 | 100.0000 | 0.100000 | 1.01972 | 750.062 | 14.5038 | 1 | 29.52998 |
| | 3386.388 | 3.386388 | 0.003386 | 0.034530 | 25.40000 | 0.491141 | 0.033863 | 1 |

DIMENSIONS

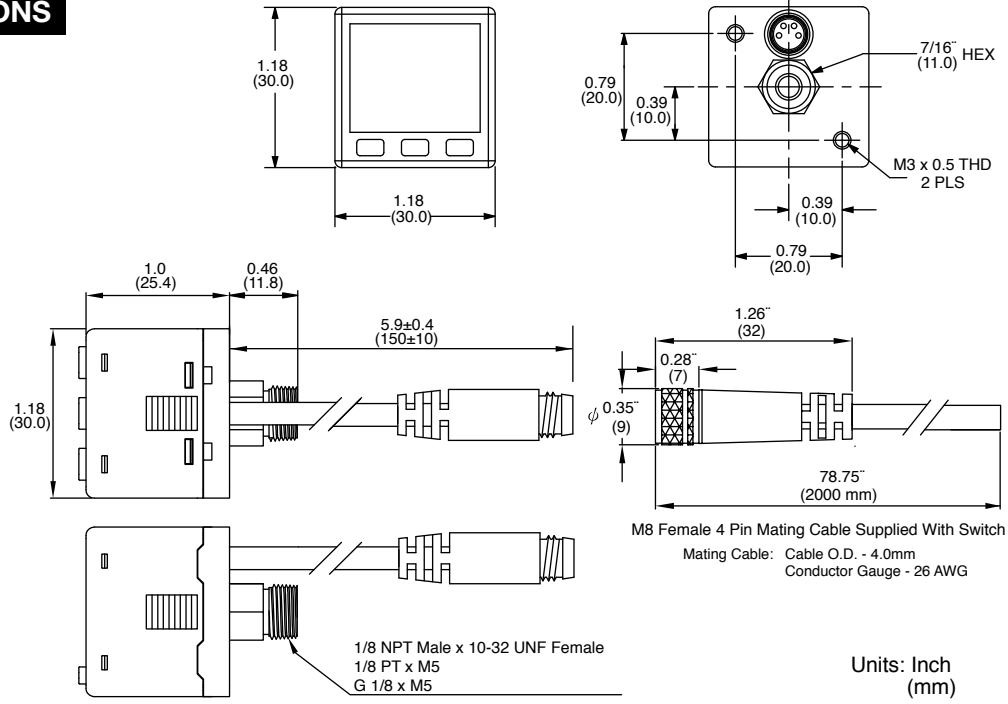

Mounting Bracket Kits (2 M3 Screws Included)

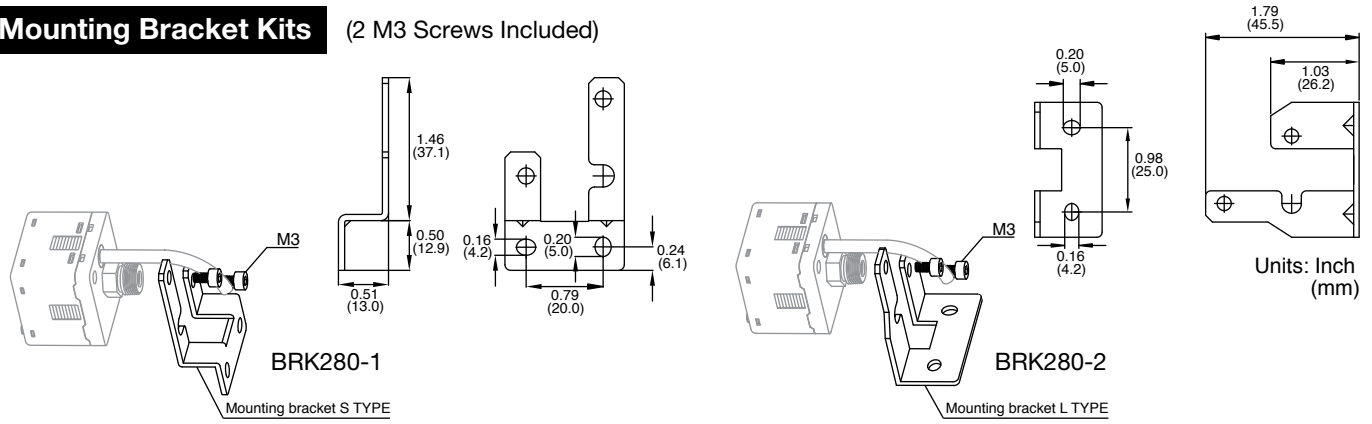

Panel Mounting Kit (Includes 2 adapters & 1 cover)

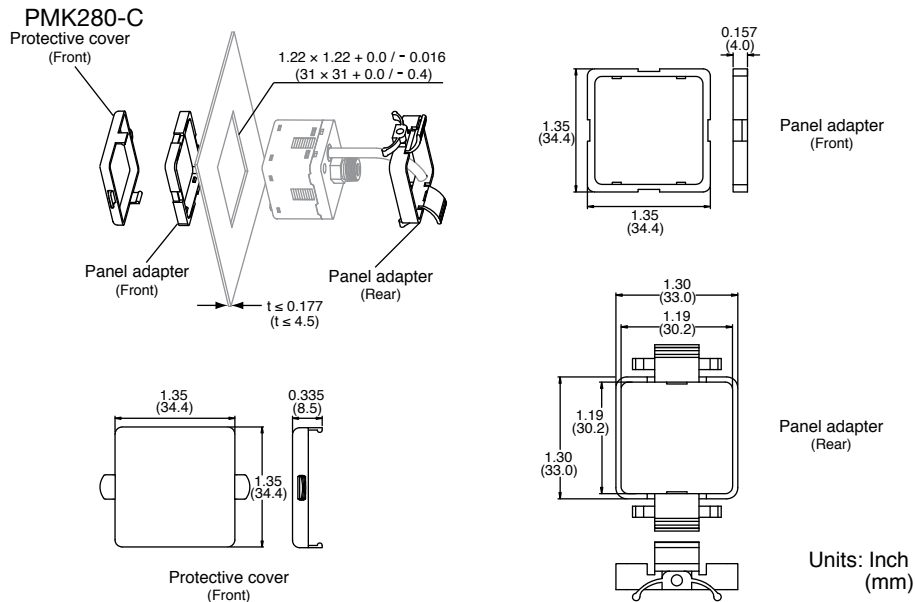

SETTING STEPS

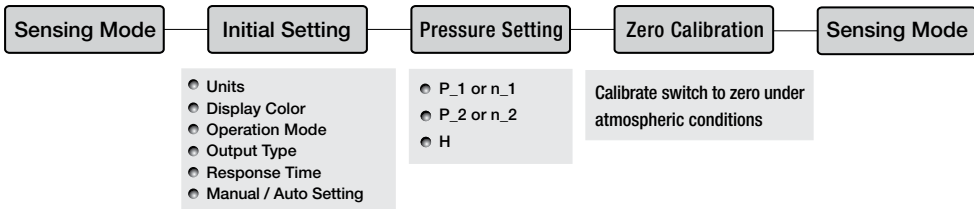

- Units
- Display Color
- Operation Mode
- Output Type
- Response Time
- Manual / Auto Setting

- P_1 or n_1
- P_2 or n_2
- H

Calibrate switch to zero under atmospheric conditions

INITIAL SETTING MODE

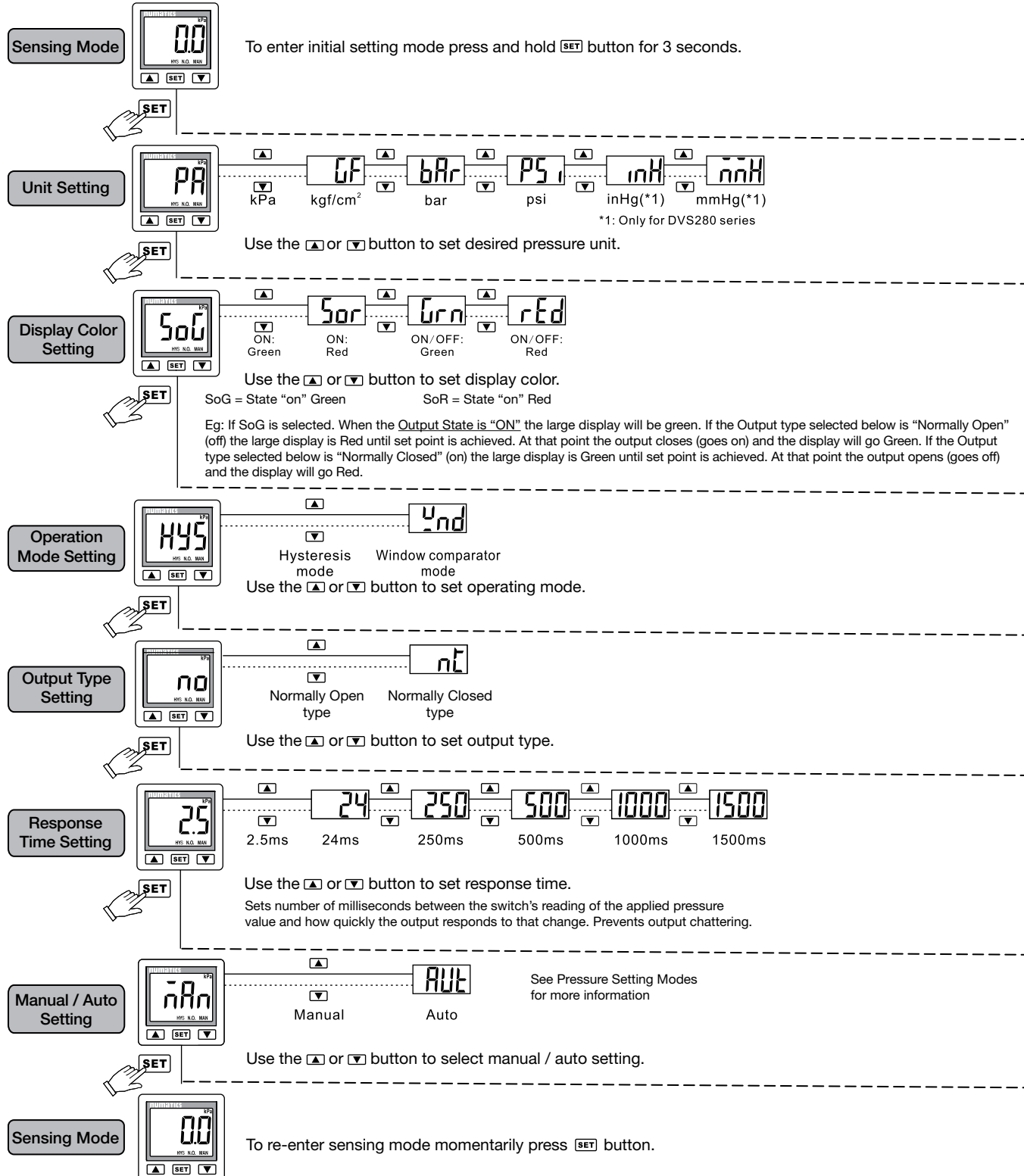

PRESSURE SETTING MODES

Select auto / manual setting mode during initial set-up.
 To enter pressure setting mode, momentarily press **[SET]** button from sensing mode.

Manual Setting Mode Use when desired Pressure and Hysteresis values are known by operator.

Hysteresis mode

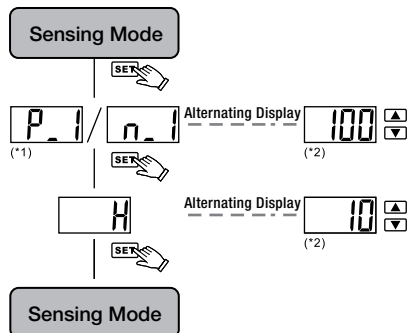

Window comparator mode

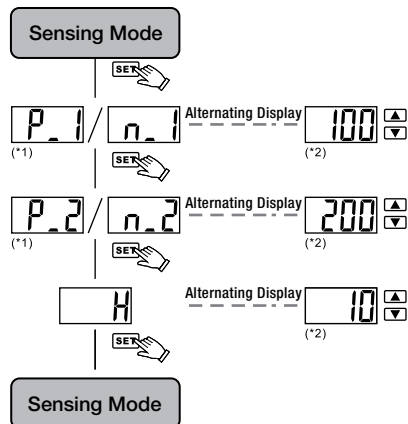

[NOTES:]

- *1. If Output Type "Normally Open" was selected the LCD - alternating display - will be (P_) or if "Normally Closed" was selected the LCD - alternating display - will be (n_) during this step.
- *2. When setting the P1 Hysteresis value or P1 / P2 Window comparator or H Hysteresis values momentarily depressing the up arrow will increase the pressure value by one digit, maintaining the up arrow will rapid increase the value. Conversely, momentarily depressing the down arrow will decrease the pressure value by one digit, maintaining the down arrow will rapid decrease the value.
3. Once the pressure setting step is complete momentarily depress **[SET]** to return to sensing mode or waiting 10 seconds will automatically default to sensing mode.

Auto Setting Mode - Hysteresis Mode Only Use when desired Pressure and Hysteresis values are not known.

The operator can teach the switch a maximum and minimum value used for P(n)1 and H calculations.
 Pressure (DPS) or Vacuum (DVS) must be applied to the switch for it to learn the two values.

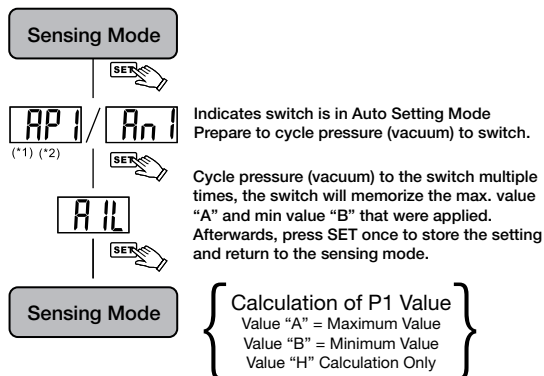

$$P1(n)1 = A - \frac{A-B}{4} \quad H = \frac{A-B}{2}$$

DPS Example:

Value "A" = 100 PSIG
 Value "B" = 80 PSIG
 $P1 = 100 - \frac{100 - 80}{4}$
 P1 = 95 PSIG
 $H = \frac{100 - 80}{2}$
 H = 10 PSIG

[NOTES:]

- *1. If Output Type "Normally Open" was selected the LCD display will be (AP 1) or if "Normally Closed" was selected the LCD display will be (An 1) during this step.
- *2. To exit Auto Setting mode with AP1 displayed, simultaneously pressing **[▲]** and **[▼]** momentarily will put the switch back to the sensing mode.
3. Once P1 and H values are established the switch will default back to Manual Setting mode allowing the operator to adjust P1 and / or H to suit application.

KEY LOCK / UNLOCK MODE

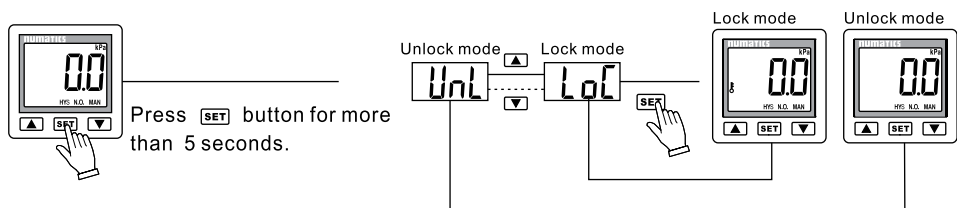

Use **[▲]** or **[▼]** to select key lock / unlock mode.
 To prevent unauthorized or accidental tampering with the switch settings select the "Lock Mode" function. Panel will display "Key symbol" (⌘).
 To enter sensing mode momentarily press **[SET]** button.

ZERO CALIBRATION / THE MAX. & MIN. DISPLAY MODE

Zero Calibration: Calibrate switch to zero under atmospheric conditions. Press the \blacktriangle + \blacktriangledown buttons at the same time until the "00" is shown. Release the buttons to end zero calibration.

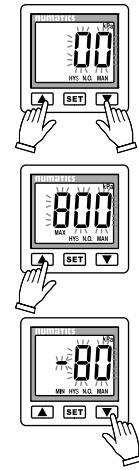

Maximum Applied Pressure Display:

Press and hold \blacktriangle button 2 seconds to enter the maximum value display mode. Panel will display "Max". The sensor will now detect and display the maximum pressure value applied, until reset. To reset, press and hold \blacktriangle button for 2 seconds to return to the sensing mode.

Minimum Applied Pressure Display:

Press and hold \blacktriangledown button 2 seconds to enter the minimum value display mode. Panel will display "Min". The sensor will now detect and display the minimum pressure value applied, until reset. To reset, press and hold \blacktriangledown button for 2 seconds to return to the sensing mode.

OUTPUT TYPE

From initial settings, digital output is selected either "Normally Open" or "Normally Closed".

In the pressure setting mode within the available set pressure range, using selected units the operator has preset the P(n)1 and/or {P(n)1 / P(n)2} and a Hysteresis (H) value.

Hysteresis mode: (N.O. example) On ascending pressure the digital output will go on value at P1 and go off when the pressure drops below P1 by the H value selected.

Window comparator mode: (N.O. example) On ascending pressure the digital output will go on at P1 and go off at P2. On descending pressure it will go on again when pressure drops below P2 by the H Value going off again when pressure drops below P1 by the H value.

Hysteresis mode

Normally Open mode

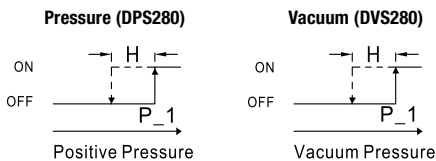

Window comparator mode

Normally Open mode

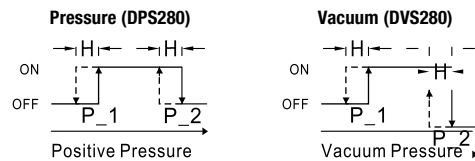

Normally Closed mode

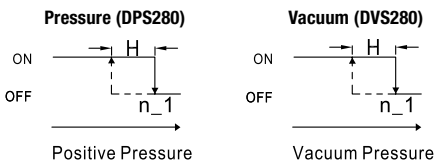

Normally Closed mode

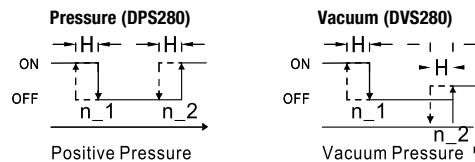

(NOTES:) It is recommended the Hysteresis value be set greater than the $\pm 0.2\%$ of FS repeatability. If set lower and the applied pressure fluctuates too near the set point, it can cause the digital output to chatter.

FINE ADJUSTMENT MODE

(Must have Pressure / Vacuum applied to adjust.)

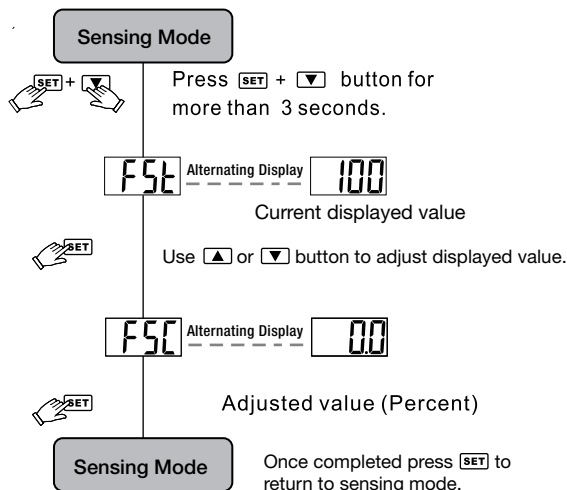

To enter fine adjustment mode simultaneously press and hold **SET** + \blacktriangledown for 3 seconds.

FSE
Use \blacktriangle or \blacktriangledown to adjust displayed value.

FSC
Adjusted Value Percentage Displayed
Once complete press **SET** to return to sensing mode.
This function allows operator to manually adjust output display values on multiple switches with identical applied pressure, therefore providing uniformity of the display values.
Displayed values of the sensor can be calibrated or adjusted to within a maximum of $\pm 5\%$ for DPS280 and $\pm 2.5\%$ for DVS280.

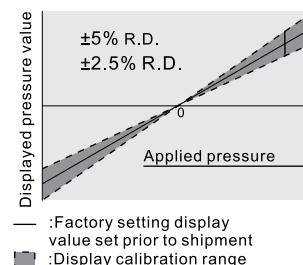

(NOTES:) DPS280 : When display unit is in "PSI", setting resolution is 0.2 PSI.
DVS280 : When display unit is in "PSI", setting resolution is 0.02 PSI.