

Thank you for purchasing the arresters.  
Please read through this manual before use for correct handling.

### CAUTIONARY NOTES FOR SAFE USE OF THE PRODUCT

This User's Manual should be carefully read before installing and operating the product. The following symbol is used on the product and in this manual to ensure safe usage.



This symbol is displayed on the product when it is necessary to refer to the User's Manual for information on personal and instrument safety. This symbol is displayed in the User's Manual to indicate precautions to avoid danger to the operator, such as an electric shock.

The following symbols are used only in this manual.



Draws attention to essential information for understanding the operations and/or functions of the product.



#### CAUTION

The arrester may deteriorate or break if it receives surges. Arresters that have deteriorated below a specific level or are broken, may fail to meet their protection performance level and must therefore be replaced. When replacing such arresters, replace both the main unit and the terminal block. It should be noted that the arrester may fail to safeguard the equipment under protection if it receives any surges exceeding its tolerance limit, such as direct lightning strokes.

### CHECKING PRODUCT SPECIFICATIONS AND PACKAGE

Check that the package contains the following items:

- AR-SY: 1
- Tag number label: 1
- Terminal cover: 2
- User's Manual (this manual)

## 1. MOUNTING AND WIRING



### WARNING

Wiring should be done after ensuring the break of each cable.

### 1.1 Mounting

Mount the arrester referring the figure below.

Unit: mm

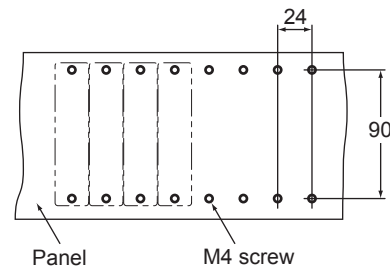

#### • FRK-16 (Panel)

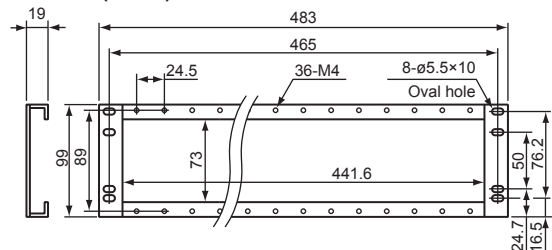

### 1.2 External Dimensions

Unit: mm

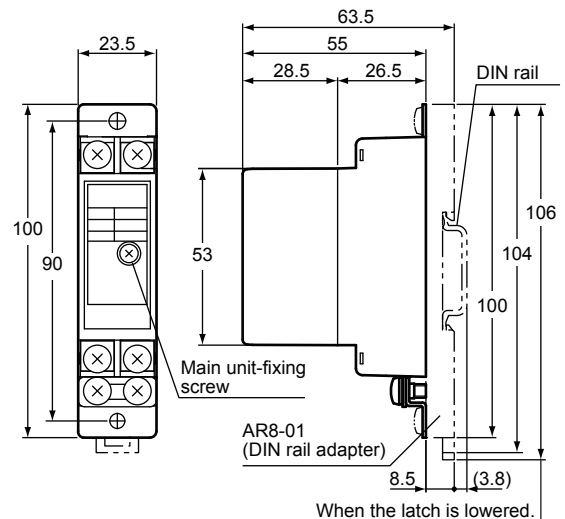

### 1.3 Terminal Arrangement

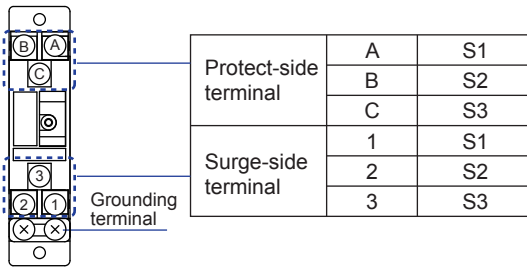

### 1.4 Wiring

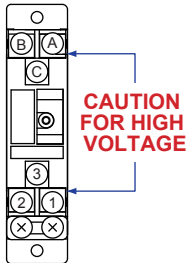

#### NOTE

Use of arresters ignoring the specifications may cause electric shock, overheating or damage.

1. Input signal value applied to the arrester should meet the required specifications.
2. The external wiring to the terminals and wiring to ground are as specifications.

Flexible twisted wire and durable round crimp-on terminal (JIS C 2805) are recommended to use.

(1) Signal cable

Nominal cross-sectional area of conductor: 0.5 to 0.75 mm<sup>2</sup>.  
Example of suitable cable: Vinyl code (VJF) (JIS C 3306) for electronic instrument.

(2) Grounding cables

Nominal cross-sectional area of conductor: 2.0 mm<sup>2</sup> or more for grounding.  
Example of suitable cable: 600V vinyl insulated cable (IV) (JIS C 3307), Vinyl insulated cable (KIV) (JIS C 3316) for electronic instrument

### 1.5 Grounding

Interconnect the ground terminals of the arrester and the instrument to be protected. Touch ground from the arrester side as shown in the figure below. Install the arrester and instrument as close as possible, and make the cable as short as possible. The wires for interconnect grounding should have lower effective resistance than ground resistance.

- Make sure to earth ground the ground terminal through minimum resistance.
- The grounding method must comply with the grounding system defined by rules and standards of the country or the region.

It also should meet the grounding requirements of the instrument to be protected.



#### NOTE

Wire tightening torque for arrester should not be 1.2 N·m or more.

- (1) Interconnect Grounding (2) Interconnect Grounding (when using shield line)

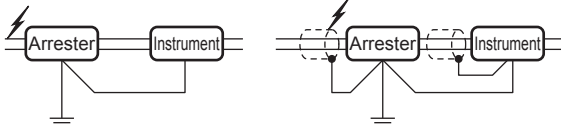

Make sure to earth ground the ground terminal through minimum resistance.

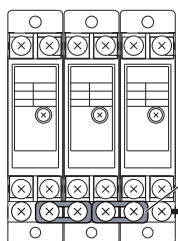

Grounding for serial installation of arresters is to connect grounding terminals of neighboring arresters to each other and touch ground at one point from last arrester according.

Short bar (for grounding terminal connection)

Apply the grounding system which is defined by the rules and standards of the country or the region.

## 2. CONNECTION OF ARRESTERS WITH INSTRUMENTS TO BE PROTECTED

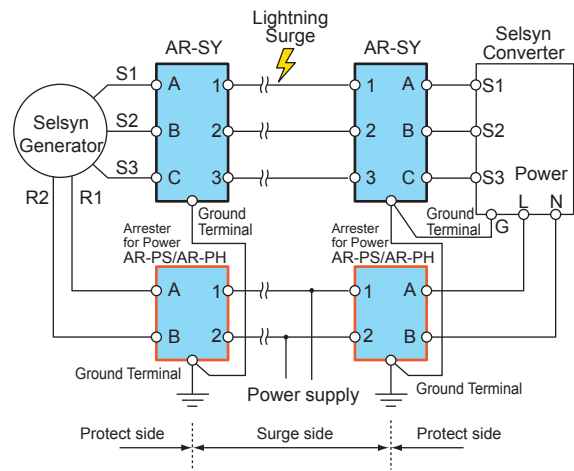

## 3. ENVIRONMENTAL CONDITIONS

Ambient temperature: -10 to +60°C  
Relative humidity: 5 to 90% RH (No condensation)  
Altitude at installation site: Max. 2000 m above sea level

## 4. MANTENABCE

### 4.1 Arrester Checking

The arrester main body and terminal base are connected by plug-in. Circuit between surge side and protect side would not be open even if the main body is removed from the socket on terminal base by loosening main unit-fixing screw. To check the arrester performance, remove the main body from the socket and check it by using the AR2-CK (arrester checker: option). If the arrester cannot be used because the main body is deteriorated or broken, be sure to replace both the main body and the terminal block. The terminal block may be damaged by receiving surges. The replacement of only the main body may fail to meet its protection performance level.

### 4.2 Arrester check period

To protect the instrument from damage by induced lightning, the arrester should be checked periodically at least once a year. In areas where lightning occurs frequently, check should be done more often particularly after thunderstorms.

## 5. HARDWARE SPECIFICATION

Use		Selsyn
* Maximum continuous operating voltage (Uc)	Between lines	110 V AC
	Between ground	110 V AC
Permissible current leakage	Between lines	1 mA or less (at 200 V DC)
	Between ground	1 mA or less (at 400 V DC)
Instrument side voltage limit (10 kV, 1.2/50 μA)	Between lines	500 V or less
	Between ground	1000 V or less
* Voltage protection level (Up)	Between lines	800 V or less
	Between ground	1500 V or less
* Impulse durability (8/20 μA)	Category C1	500 A
	Category C2	1000 A
Discharge starting voltage	Between lines	240 V DC or more
	Between ground	420 V DC or more
* Rated current		2 A AC
JIS compliant	JIS C 5381-21 (Category: C1, C2)	

\*: Description compliant with JIS C 5381-21.