

DPharp  
BRAIN Communication Type  
(EJX□□□A, EJA□□□E)

IM 01C25T03-01E



# DPharp

## BRAIN Communication Type

IM 01C25T03-01E 9th Edition

## Contents

<b>1.</b>	<b>Introduction.....</b>	<b>1-1</b>
	<b>■ Regarding This Manual.....</b>	<b>1-1</b>
1.1	<b>Safe Use of This Product .....</b>	<b>1-2</b>
1.2	<b>Warranty.....</b>	<b>1-3</b>
<b>2.</b>	<b>Connection.....</b>	<b>2-1</b>
2.1	<b>Connecting the BT200.....</b>	<b>2-1</b>
2.2	<b>Communication Line Requirements.....</b>	<b>2-1</b>
2.3	<b>Power Supply Voltage and Load Resistance.....</b>	<b>2-2</b>
2.4	<b>Integral Indicator Display When Powering On .....</b>	<b>2-2</b>
<b>3.</b>	<b>Operation.....</b>	<b>3-1</b>
3.1	<b>BT200 Operating Procedures .....</b>	<b>3-1</b>
3.1.1	Key Layout and Screen Display.....	3-1
3.1.2	Operating Key Functions .....	3-1
(1)	Alphanumeric Keys and Shift Keys.....	3-1
(2)	Function Keys.....	3-2
3.1.3	Calling Up Menu Addresses Using the Operating Keys .....	3-3
3.1.4	Printout (for BT200 printer option) .....	3-3
(1)	Printout of All Parameters.....	3-3
(2)	Printout by Menu Item .....	3-3
3.2	<b>Setting Parameters Using the BT200 .....</b>	<b>3-4</b>
3.2.1	Parameter Usage and Selection.....	3-4
3.2.2	Menu Tree .....	3-5
3.2.3	Setting Parameters .....	3-6
(1)	Tag No. Setup .....	3-6
(2)	Calibration Range Setup .....	3-6
(3)	Damping Time Constant Setup .....	3-8
(4)	Output Mode and Integral Indicator Display Mode Setup .....	3-8
(5)	Output Signal Low Cut Mode Setup .....	3-8
(6)	Integral Indicator Scale Setup .....	3-9
(7)	Unit Setup for Displayed Temperature .....	3-11
(8)	Operation Mode Setup .....	3-11
(9)	Impulse Line Connection Orientation Setup .....	3-11
(10)	CPU Failure Burnout Direction and Hardware Write Protect .....	3-12

---

(11) Software Write Protect .....	3-12
(12) Output Status Setup when a Hardware Error Occurs .....	3-13
(13) Bi-directional Flow Measurement Setup .....	3-13
(14) Range Change while Applying Actual Inputs .....	3-14
(15) Sensor Trim .....	3-14
(16) Test Output Setup .....	3-18
(17) Signal Characterizer .....	3-18
(18) Process Alarm .....	3-19
(19) Status Output (option code AL) .....	3-20
(20) Capillary Fill Fluid Density Compensation .....	3-21
(21) Adjustment Information and User Memo Fields .....	3-22
<b>3.3 Displaying Data Using the BT200.....</b>	<b>3-22</b>
3.3.1 Displaying Measured Data.....	3-22
3.3.2 Display Transmitter Model and Specifications.....	3-22
<b>4. Self-diagnostics.....</b>	<b>4-1</b>
<b>4.1 Checking for Problems .....</b>	<b>4-1</b>
4.1.1 Identifying Problems with BT200 .....	4-1
4.1.2 Checking with Integral Indicator.....	4-2
<b>4.2 Alarms and Countermeasures .....</b>	<b>4-2</b>
<b>5. Parameter Summary .....</b>	<b>5-1</b>
<b>Appendix 1. Safety Instrumented Systems Installation .....</b>	<b>A1-1</b>
<b>Revision Information</b>	

# 1. Introduction

Thank you for purchasing the DPharp EJX series pressure transmitter/EJA series pressure transmitter (“transmitter”).

The transmitters are precisely calibrated at the factory before shipment. To ensure both safety and efficiency, please read this manual carefully before operating the instrument.

This manual describes the BRAIN protocol communication functions of the transmitter and explains how to set the parameters for the transmitters using the BT200 handheld terminal. For information on the installation, wiring, and maintenance of the transmitters, please refer to the user’s manual of each model.

## **WARNING**

When using the transmitters in a Safety Instrumented System application, refer to the Functional Safety Manual (Document No.: TI 01C25A05-01EN or TI 01C25A05-21EN for option code SLT) and follow the instructions and procedures described there. The document can be downloaded from the website of Yokogawa. (Website address:

<https://www.yokogawa.com/solutions/products-platforms/field-instruments/>)

In order to satisfy the requirement of Safety Instrumented System, executing parameters setting is required. Please refer to 3.2 “Setting Parameters Using the BT200” for setting range. Please also refer to the status output setting in the same clause. After installing the transmitter, confirm that the range and unit is set correctly. Calibration of the transmitters shall be done after completing the range setting.

## ■ Regarding This Manual

- This manual should be provided on to the end user.
- The contents of this manual are subject to change without prior notice.
- All rights reserved. No part of this manual may be reproduced in any form without Yokogawa’s written permission.

- Yokogawa makes no warranty of any kind with regard to this manual, including, but not limited to, implied warranty of merchantability and fitness for a particular purpose.
- If any question arises or errors are found, or if any information is missing from this manual, please inform the nearest Yokogawa sales office.
- The specifications covered by this manual are limited to those for the standard type under the specified model number break-down and do not cover custom-made instruments.
- Please note that changes in the specifications, construction, or component parts of the instrument may not immediately be reflected in this manual at the time of change, provided that postponement of revisions will not cause difficulty to the user from a functional or performance standpoint.
- The following safety symbols are used in this manual:

## **WARNING**

Indicates a potentially hazardous situation which, if not avoided, could result in death or serious injury.

## **CAUTION**

Indicates a potentially hazardous situation which, if not avoided, may result in minor or moderate injury. It may also be used to alert against unsafe practices.

## **IMPORTANT**

Indicates that operating the hardware or software in this manner may damage it or lead to system failure.

## **NOTE**

Draws attention to information essential for understanding the operation and features.

## 1.1 Safe Use of This Product

For the safety of the operator and to protect the instrument and the system, please be sure to follow this manual's safety instructions when handling this instrument. If these instructions are not heeded, the protection provided by this instrument may be impaired. In this case, Yokogawa cannot guarantee that the instrument can be safely operated. Please pay special attention to the following points:

### (a) Installation

- This instrument may only be installed by an engineer or technician who has an expert knowledge of this device. Operators are not allowed to carry out installation unless they meet this condition.
- With high process temperatures, care must be taken not to burn yourself by touching the instrument or its casing.
- Never loosen the process connector nuts when the instrument is installed in a process. This can lead to a sudden, explosive release of process fluids.
- When draining condensate from the pressure detector section, take appropriate precautions to prevent the inhalation of harmful vapors and the contact of toxic process fluids with the skin or eyes.
- When removing the instrument from a hazardous process, avoid contact with the process fluid and the interior of the meter.
- All installation shall comply with local installation requirements and the local electrical code.

### (b) Wiring

- The instrument must be installed by an engineer or technician who has an expert knowledge of this instrument. Operators are not permitted to carry out wiring unless they meet this condition.
- Before connecting the power cables, please confirm that there is no current flowing through the cables and that the power supply to the instrument is switched off.

### (c) Operation

- Wait 10 min. after the power is turned off, before opening the covers.

### (d) Maintenance

- Please carry out only the maintenance procedures described in this manual. If you require further assistance, please contact the nearest Yokogawa office.
- Care should be taken to prevent the build up of dust or other materials on the display glass and the name plate. To clean these surfaces, use a soft, dry cloth.

### (e) Modification

- Yokogawa will not be liable for malfunctions or damage resulting from any modification made to this instrument by the customer.

---

## 1.2 Warranty

- The warranty shall cover the period noted on the quotation presented to the purchaser at the time of purchase. Problems occurring during the warranty period shall basically be repaired free of charge.
- If any problems are experienced with this instrument, the customer should contact the Yokogawa representative from which this instrument was purchased or the nearest Yokogawa office.
- If a problem arises with this instrument, please inform us of the nature of the problem and the circumstances under which it developed, including the model specification and serial number. Any diagrams, data and other information you can include in your communication will also be helpful.
- The party responsible for the cost of fixing the problem shall be determined by Yokogawa following an investigation conducted by Yokogawa.
- The purchaser shall bear the responsibility for repair costs, even during the warranty period, if the malfunction is due to:
  - Improper and/or inadequate maintenance by the purchaser.
  - Malfunction or damage due to a failure to handle, use, or store the instrument in accordance with the design specifications.
  - Use of the product in question in a location not conforming to the standards specified by Yokogawa, or due to improper maintenance of the installation location.
  - Failure or damage due to modification or repair by any party except Yokogawa or an approved representative of Yokogawa.
  - Malfunction or damage from improper relocation of the product in question after delivery.
  - Reason of force majeure such as fires, earthquakes, storms/floods, thunder/lightening, or other natural disasters, or disturbances, riots, warfare, or radioactive contamination.

# 2. Connection

The BRAIN communication signal is superimposed onto the 4 to 20 mA DC analog signal. Since the modulated wave is a communication signal, superimposing it on the normal signal will, from basic principles, cause no error in the DC component of the analog signal. Thus, monitoring can be performed via the BT200 while the transmitter is on-line.

## 2.1 Connecting the BT200



### IMPORTANT

Analog output may change temporarily in connecting with BRAIN terminal due to an initial current flowed to it. To prevent communication signal affecting the upper system, it is recommended to install a low-pass filter (approximately 0.1s)

Connection to the transmitter with the BT200 can be made by either connecting to the BT200 connection hooks in the transmitter terminal box or by connecting to a relaying terminal or a terminal board.

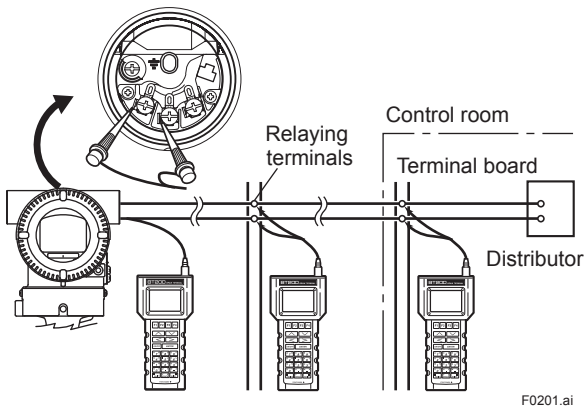

Figure 2.1 Connecting the BT200

## 2.2 Communication Line Requirements

[Protocol specification] Yokogawa original protocol

[Modulation] Burst modulation

0: 2400Hz

1: Signal without carrier

[Baud rate] 1200bps

[Communication signal]

host to device: +/- 0.5V (load resistance 250Ω)

device to host: +/- 2mA

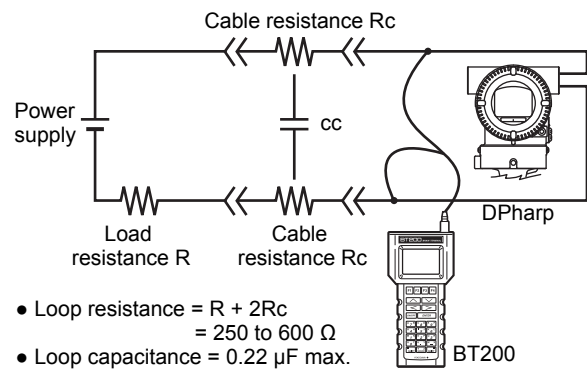

F0202.ai

Figure 2.2 Communication Line Requirements

### 2.3 Power Supply Voltage and Load Resistance

When configuring the loop, make sure that the external load resistance is within the range in the figure below.

(Note) With an intrinsically safe transmitter, external load resistance includes safety barrier resistance.

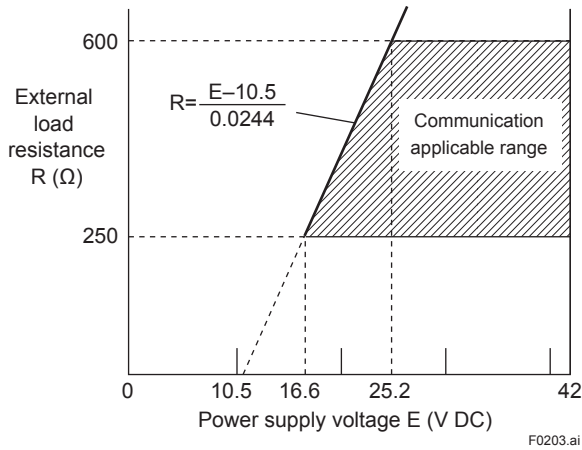
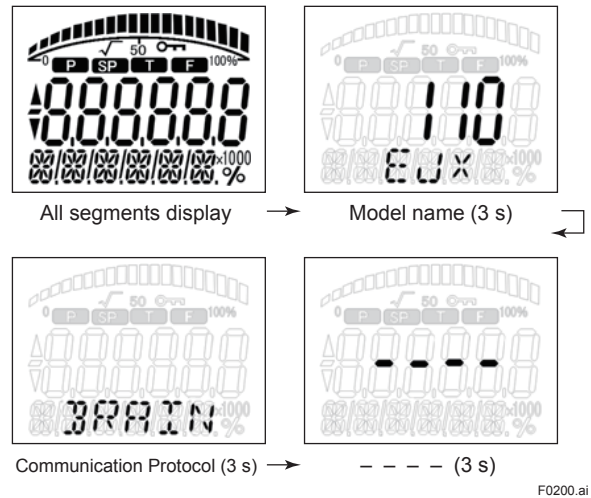

Figure 2.3 Relationship between Power Supply Voltage and External Load Resistance

### 2.4 Integral Indicator Display When Powering On

For models with the integral indicator code “D”, the display shows all segments in the LCD and then changes to the displays shown below sequentially.



#### NOTE

For output signal code “D”, this function is available for software revision 2.02 or later. Software revision can be checked by the parameter M15: SOFT REV. Refer to section 3 “Operation” how to call up the parameter.



#### NOTE

LCD display can be set to all segments display only by the parameter I41: POWER ON INF.

ON	Show All segments display, Model name and Communication Protocol when powering on.
OFF	Show All segments display when powering on.

Refer to section 3 “Operation” how to call up the parameter.



# 3. Operation

The transmitter is equipped with BRAIN communications capabilities, so that range changes, Tag No. setup, monitoring of self-diagnostic results, and zero point adjustment can be handled remotely via the BT200 BRAIN TERMINAL, the FieldMate Versatile Device Management Wizard or the CENTUM CS console. This section describes procedures for setting parameters using the BT200. For further information on the BT200, see the BT200 User's Manual (IM 01C00A11-01E).



## IMPORTANT

Communication signal is superimposed on analog output signal. It is recommended to set a low-pass filter (approximately 0.1s) to the receiver in order to reduce the output effect from communication signal. Before online-communication, confirm that communication signal does not give effect on the upper system.

### 3.1 BT200 Operating Procedures

#### 3.1.1 Key Layout and Screen Display

Figure 3.1 shows the arrangement of the operating keys on the BT200 keypad, and figure 3.2 shows the BT200 screen.

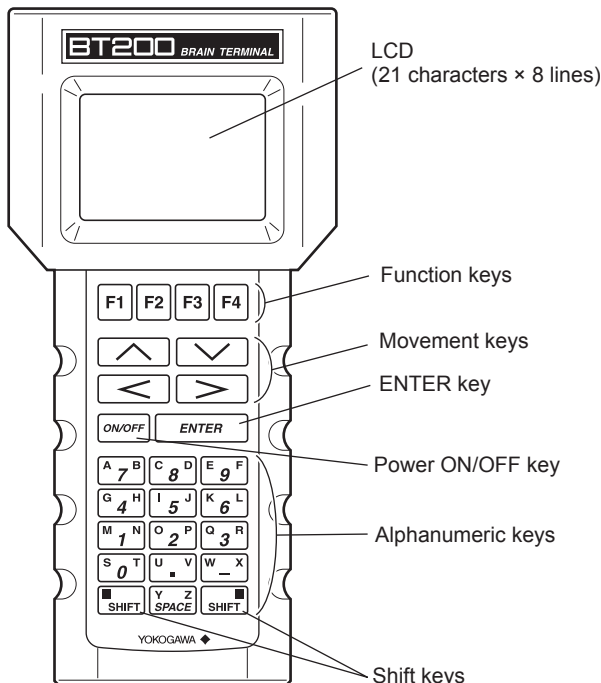

F0301.ai

Figure 3.1 BT200 Key Layout

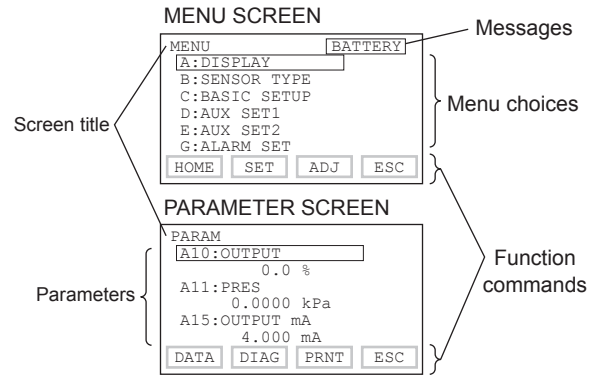

F0302.ai

Figure 3.2 BT200 Screen

#### 3.1.2 Operating Key Functions

##### (1) Alphanumeric Keys and Shift Keys

Use the alphanumeric keys in conjunction with the shift keys to enter numbers, symbols, and alphabetic characters.

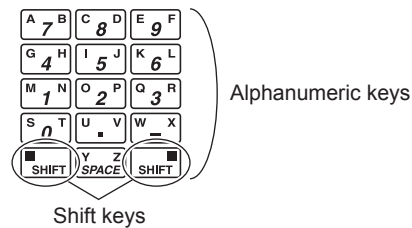

F0303.ai

##### a. Entering Numbers, Symbols, and Spaces

Simply press the alphanumeric keys.

Entry	Key-in sequence
-4	[W _ X] [G 4 H]
0.3	[S 0 T] [U . V] [Q 3 R]
1 _ -9	[M 1 N] [Y SPACE Z] [W _ X] [E 9 F]

F0304.ai

**b. Entering Alphabetic Characters**

Press either the left or right shift key and then an alphanumeric key to enter the desired alphabetic character. The shift key must be pressed each time an alphabetic character is entered.

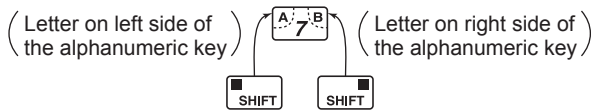

Entry	Key-in sequence
W	W X
IC	I J  C D
J. B	I J  U V  A B

F0305.ai

Use the function key [F2] to select uppercase and lowercase (for alphabetic characters only). The case toggles between uppercase and lowercase each time [F2] CAPS is pressed.



Entry	Key-in sequence
Boy	A B   O P  Y Z (B) (o) (y)

F0306.ai

Use the function key [F1] to enter symbols. The following symbols will appear in sequence, one at a time, at the cursor each time [F1] CODE is pressed:

/ . - , + \* ) ( ' & % \$ # " !

To enter characters next to these symbols, press [ > ] to move the cursor.

Entry	Key-in Sequence
l/m	symbol command   K L    M N (l) (/) (m)

F0307.ai

**(2) Function Keys**

The function command carried out by each function key is displayed directly above the key.

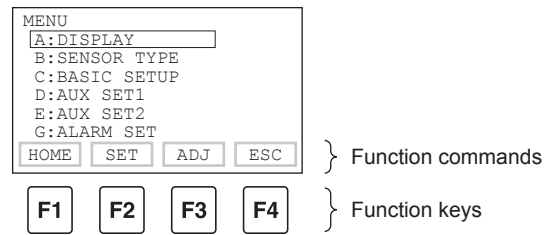

F0308.ai

**Function Command List**

Command	Function
ADJ	Displays the ADJ menu
CAPS/caps	Selects uppercase or lowercase
CODE	Selects symbols
CLR	Erases input data or deletes all data
DATA	Updates parameter data
DEL	Deletes one character
DIAG	Calls the self-check panel
ESC	Returns to the most recent display
HOME	Displays the menu panel
NO	Quits setup and returns to the previous display
OK	Proceeds to the next panel
PRAM	Enters the parameter number setup mode
SET	Displays the SET menu
SLOT	Returns to the slot selection panel
UTIL	Calls the utility panel
*COPY	Prints out parameters on display
*FEED	Paper feed
*LIST	Lists all parameters in the menu
*PON/POFF	Automatic printout mode on or off
*PRNT	Changes to the print mode
*GO	Starts printing
*STOP	Cancel printing

\* Available on BT200-P00 (with printer).

### 3.1.3 Calling Up Menu Addresses Using the Operating Keys

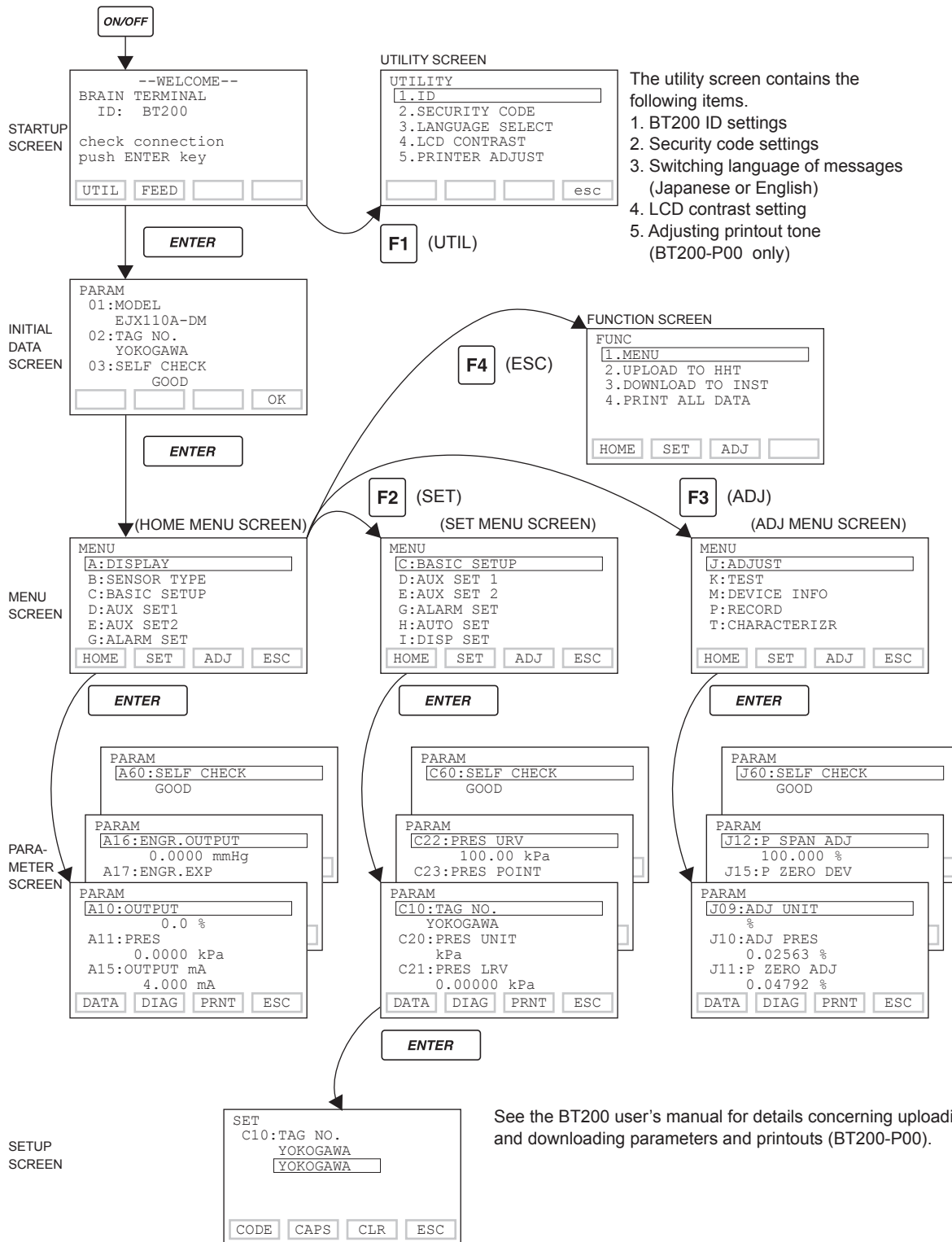

See the BT200 user's manual for details concerning uploading and downloading parameters and printouts (BT200-P00).

F0309.ai

### 3.1.4 Printout (for BT200 printer option)

#### (1) Printout of All Parameters

Select 4. *PRINT ALL DATA* from the function screen to output a list of all parameters. It takes about 10 minutes to complete the printout.

#### (2) Printout by Menu Item

To printout the parameters for a specific screen, push the function key corresponding to screen's **PRNT**.

## 3.2 Setting Parameters Using the BT200



### IMPORTANT

After setting and sending data with the BT200, wait 30 seconds before turning off the transmitter. If it is turned off too soon, the settings will not be stored in the transmitter.

### 3.2.1 Parameter Usage and Selection

Before setting a parameter, please see the following table for a summary of how and when each parameter is used.

**Table 3.1 Parameter Usage and Selection**

Setup item	Description
Tag No. setup ▶ P.3-6	Sets the Tag No. (using 16 alphanumeric characters).
Calibration range setup ▶ P.3-6	Sets the calibration range for 4 to 20 mA DC. Sets the following items: range unit, input value at 4 mA DC (LRV), input value at 20 mA DC (URV), and decimal point position. Note: LRV and URV can be specified with range value specifications up to 5 digits (excluding any decimal point) within the range of -32000 to 32000.
Damping time constant setup ▶ P.3-8	Adjusts the output response speed for 4 to 20 mA DC at amplifier. Can be set from 0.50 to 100.00 s. (from 0.00 to 100.00 s with quick response mode on)
Output and integral indicator display mode setup ▶ P.3-8	Sets modes for output signal and integral indicator to Linear mode (proportional to input differential pressure) or to Square root mode (proportional to flow).
Output signal low cut mode setup ▶ P.3-8	Used mainly to stabilize output near 0% if the output signal is square root mode. Two modes are available: forcing output to 0% for input below a specific value, or changing to proportional output for input below a specific value.
Integral indicator display function ▶ P.3-9	Available from the following 5 types of integral indicator scale ranges and units: input pressure, % of range, user set scale, input static pressure, % of static pressure range, and alternating among any four of the above. Configure the following when using the user set scale; user set scale setting, unit (BT200 only), display value at 4 mA DC (LRV), and display value at 20 mA DC (URV). Note: LRV and URV can be specified with range value specifications up to 5 digits (excluding any decimal point) within the range of -32000 to 32000.
Static pressure setup ▶ P.3-11	Sets the parameters concerned with static pressure such as unit, calibration range, upper and lower range values, decimal point position, damping time constant.
Unit setup for displayed temperature ▶ P.3-11	Sets the unit for temperatures displayed on the BT200.
Operation mode (normal/reverse signal) setup ▶ P.3-11	Reverses the direction for 4 to 20 mA DC output relative to input. Reverse mode is used for applications in which safety requires that output be driven toward 20 mA if input is lost.
Impulse line connection orientation (higher pressure on right/left side) setup ▶ P.3-11	Used where installation conditions make it imperative to connect high pressure side impulse line to low pressure side of transmitter. Reversal of orientation should be dealt with by reversing impulse line wherever possible. Use this function only where there is no alternative.
CPU Failure burnout direction and hardware write protect ▶ P.3-12	Displays the status of 4 to 20 mA DC output when a CPU fails. The direction is selectable by the hardware switch on the amplifier. It also physically prevents parameter access
Software write protect ▶ P.3-12	Configured data can be protected by setting a password.
Output status setup when a hardware error occurs ▶ P.3-13	Sets the status of the 4 to 20 mA DC output when an abnormal status is detected with the capsule or the amplifier as the result of self-diagnosis. Either the last held, high limit, or low limit values status, can be selected.
Bi-directional flow measurement ▶ P.3-13	Used to measure bi-directional flows. Output at zero flow is 12 mA DC, with output range equally divided between forward and reverse flow. Can be used with square root mode.
Range change while applying actual inputs ▶ P.3-14	Range for 4 to 20 mA DC signal is set with actual input applied. Sets 20 mA DC output precisely with respect to user's reference instrument output. Note that the transmitter is calibrated with high accuracy before shipment, so span should be set using the normal range setup.
Sensor trim ▶ P.3-14	Adjusts zero point and span of the sensor.
Test output (fixed current output) setup ▶ P.3-18	Used for loop checks. Output can be set freely from -2.50% to 110.00% in 0.01% steps.
Signal characterizer ▶ P.3-18	Used to compensate the output for the non-linear application.
Process alarm ▶ P.3-19	Used for alarm generation on the integral indicator.
Status output ▶ P.3-20	Outputs an on/off digital signal based on the settings of process alarm.
Capillary fill fluid density compensation ▶ P.3-21	Compensates the zero shift by the ambient temperature effect on the capillary tubes.
User memo fields ▶ P.3-22	Allows user to enter up to 3 items, each containing any combination of up to 16 alphanumeric characters.

### 3.2.2 Menu Tree

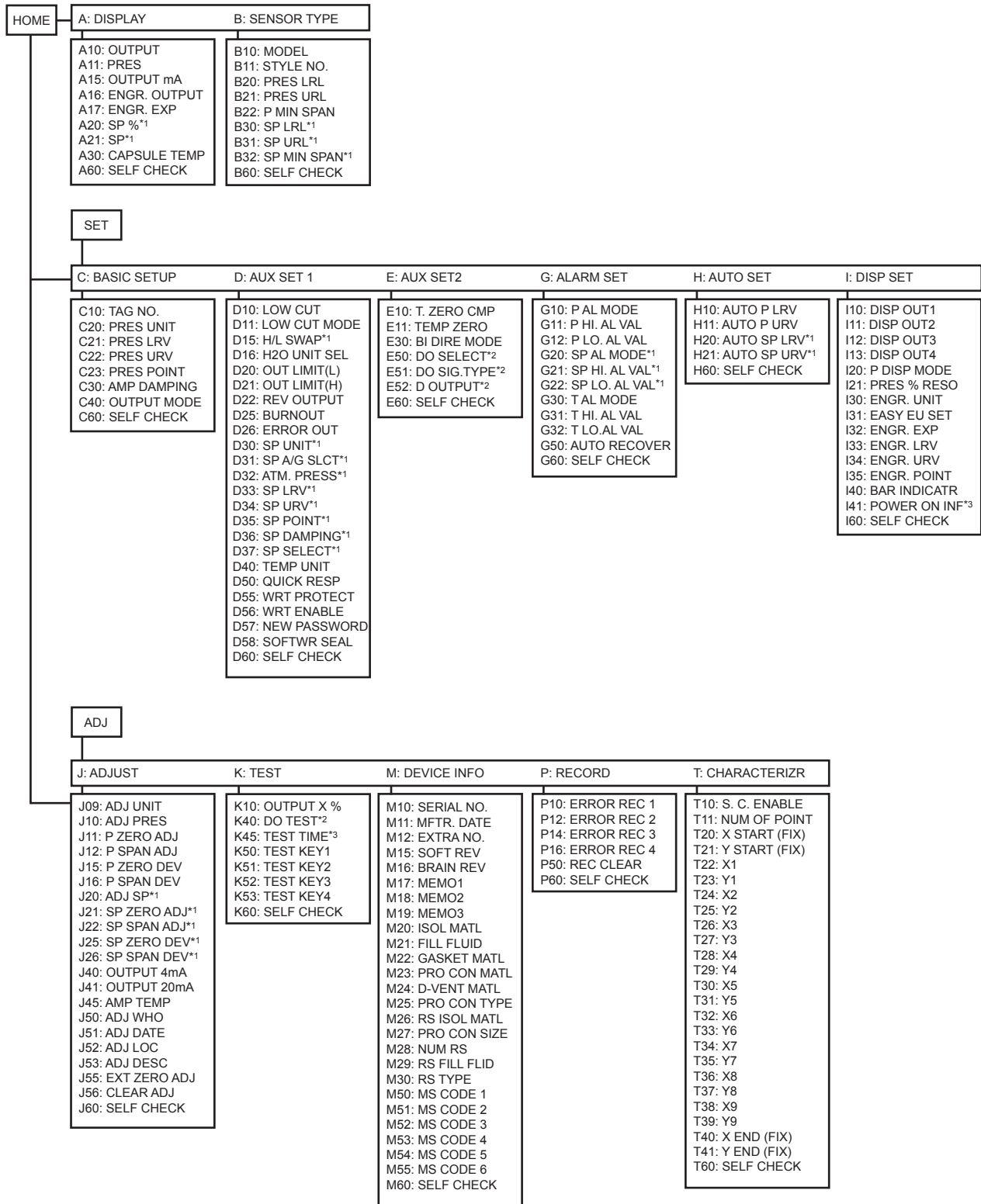

\*1: Available for differential pressure transmitter.

\*2: Available for EJX series only.

\*3: Available for software revision 2.02 or later.

Software revision can be checked by the parameter M15: SOFT REV.

### 3.2.3 Setting Parameters

Set or change the parameters as necessary. After completing these, do not fail to use the “DIAG” key to confirm that “GOOD” is displayed for the self-diagnostic result at **\_60: SELF CHECK**.

#### (1) Tag No. Setup (C10: TAG NO)

Use the procedure below to change the Tag No. Up to 16 alphanumeric characters can be entered.

- Example: Set a Tag No. to FIC-1a

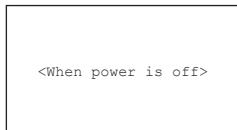

Press the **ON/OFF** key to turn on the BT200.



Connect the transmitter and BT200 using a communication cable and press the **ENTER** key.

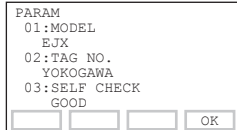

Displays the model name of connected transmitter, TAG NO. and diagnostics information. Press the **F4** (OK) key after confirmation.

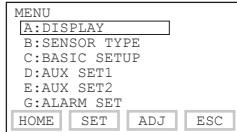

Press the **F2** (SET) key to display the SET menu panel.

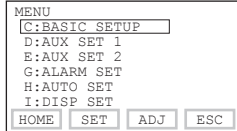

Select C: BASIC SETUP and press the **ENTER** key.

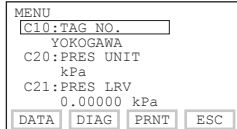

Select C10: TAG NO. and press the **ENTER** key.

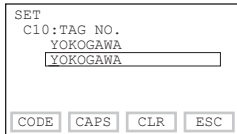

Set the new TAG NO. (FIC-1a).

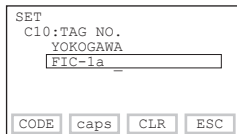
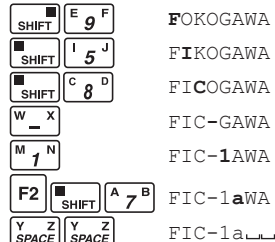

Set TAG NO. and press the **ENTER** key.

When you have made an entry mistake, return the cursor using the **<** key, then reenter.

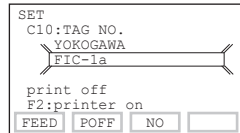

This is the panel for confirming set data. The set data items flash. When all items have been confirmed, press the **ENTER** again. (To go back to the setting panel, press the **F3** (NO) key.



The DPharp TAG NO. was overwritten. Press the **F4** (OK) key to return to the parameter panel.

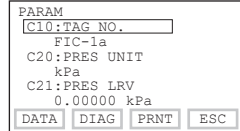

Press the **F3** (NO) key to return to the setting panel.

F0311\_2.ai

#### (2) Calibration Range Setup

##### a. Setting Calibration Range Unit (C20: PRES UNIT)

The unit parameter is set at the factory before shipment if specified at the time of order. Follow the procedure below to change the unit parameter.

- Example: Change the unit from mmH2O to kPa.

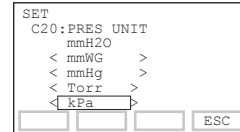

Use the **↑** or **↓** key to select kPa.

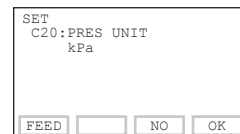

Press the **ENTER** key twice to enter the setting.

Press the **F4** (OK) key.

F0312.ai

Note that the Yokogawa default setting for the standard temperature is 4°C (39.2°F). For the units of mmH2O, mmAq, mmWG, inH2O, and ftH2O, the pressure varies according to the standard temperature definition. When a standard temperature of 20°C (68°F) is required, select @20degC (68.0F) at the parameter D16:H2O UNIT SEL.

Available pressure units are shown below.

mmH2O	MPa	inHg
mmAq	mbar	ftH2O
mmWG	bar	psi
mmHg	gf/cm2	atm
Torr	kgf/cm2	Pa
kPa	inH2O	hPa

F0311\_1.ai

**b. Setting Calibration Range Lower Range Value and Upper Range Value (C21: PRES LRV, C22: PRES URV)**

These range values are set as specified in the order before the instrument is shipped. Follow the procedure below to change the range.

The measurement range setting is used for correlating the 4-20 mA signal with the pressure value, therefore setting the measurement range in the safety instrumentation system is the setting of safety related parameters, and entering incorrect values may lead to dangerous events. When the pressure is over the range, output signal is saturated only within the normal operation range between the upper range value(URV) and the lower range value(LRV), and the 4 to 20 mA output does not enter the burnout state. Behaviors under “pressure over range” are not intended for behavior in safety instrumented systems.

“Pressure over range” of EJX/EJA is available as an alarm, not related to safety, via communication function or LCD display.

- The measurement span is determined by the upper and lower range limit values. In this instrument, changing the lower range value also automatically changes the upper range value, keeping the span constant.

- Entering the range values as LRV>URV reverses the direction of the output signal of 4-20 mA to 20-4 mA corresponding to the calibration range of 0 to 100%.
- Calibration range can be specified with range value specifications up to 5 digits (excluding any decimal point) for lower or upper range limits within the range of -32000 to 32000.
- Note, however, that changing the upper range value does not cause the lower range value to change. Thus, changing the upper range value also changes the span.

- Example 1: With present settings of 0 to 30 kPa, set the lower range value to 0.5 kPa.

```
SET
C21: PRES LRV
  0 kPa
+ 0.5
```

DEL CLR ESC

**Set 0.5.**  
Press the **ENTER** key twice to enter the setting.

```
SET
C21: PRES LRV
  0.5 kPa
```

FEED NO OK

Press the **F4** (OK) key.

```
PARAM
C20: PRES UNIT
  kPa
C21: PRES LRV
  0.5 kPa
C22: PRES URV
  30.5 kPa
```

DATA DIAG PRNT ESC

The upper range value is changed while the span remains constant.

( Span = Upper range value – Lower range value )

F0313.ai

- Example 2: With present settings of 0 to 30 kPa, set the upper range value to 10 kPa.

```
SET
C22: PRES URV
  30 kPa
+ 10
```

DEL CLR ESC

**Set 10.**  
Press the **ENTER** key twice to enter the setting.

```
SET
C22: PRES URV
  10 kPa
```

FEED NO OK

Press the **F4** (OK) key.

```
PARAM
C20: PRES UNIT
  kPa
C21: PRES LRV
  0 kPa
C22: PRES URV
  10 kPa
```

DATA DIAG PRNT ESC

The lower range value is not changed, so the span changes.

F0314.ai



### (3) Damping Time Constant Setup

#### (C30: AMP DAMPING)

When the instrument is shipped, the damping time constant is set at 2.00 seconds unless otherwise specified in the order. Follow the procedure below to change the damping time constant.

Note that setting the quick response parameter (D50: QUICK RESP) ON enables you to set the damping time constant between 0.00 to 0.49 second.

- Example: Change from 2.00 to 4.00 seconds.

Enter 4.  
Press the **ENTER** key twice to enter the setting.

Press the **F4** (OK) key.

F0315.ai

- Note 1: The damping time constant set here is the time constant for the amplifier assembly. The damping time constant for the entire transmitter is the sum of the values for the amplifier assembly and for the capsule assembly.
- Note 2: When the damping time constant is set to less than 0.5 second, communication may occasionally be unavailable during the operation, especially while output changes dynamically.

### (4) Output Mode and Integral Indicator Display Mode Setup

#### (C40: OUTPUT MODE, I20: P DISP MODE)

The mode setting for the output signal and the integral indicator can be performed independently.

This mode is set as specified in the order when the instrument is shipped. Follow the procedure below to change the mode.

If the instrument is equipped with an integral indicator and the display mode is **SQUARE ROOT**, “√” is displayed on the integral indicator.

- Output mode for 4-20 mA output

- Example: Set output mode from **Linear** to **Square root**.

Use the **▲** or **▼** key to select **SQUARE ROOT**.  
Press the **ENTER** key twice to enter the setting.

Press the **F4** (OK) key.

F0316.ai

- Integral indicator display mode

- Example: Set display mode from **Linear** to **Square root**.

Use the **▲** or **▼** key to select **SQUARE ROOT**.  
Press the **ENTER** key twice to enter the setting.

Press the **F4** (OK) key.

F0317.ai

### (5) Output Signal Low Cut Mode Setup (D10: LOW CUT, D11: LOW CUT MODE)

Low cut mode can be used to stabilize the output signal near the zero point. The low cut point can be set in a range from 0 to 20%, the direct ratio corresponding to the output signal of 4 to 20 mA. (Hysteresis: ±10% of the cut point)

Either **LINEAR** or **ZERO** can be selected as the low cut mode. Unless otherwise specified, the cut mode is set to **LINEAR** at the factory.

Note that when the output modes of the output signal and the integral indicator are selected as **SQUARE ROOT** and **LINEAR** accordingly, the low cut function is not available for the integral indicator display.



- Example: Change the low cut setting range from 10% to 20%, and the low cut mode from **LINEAR** to **ZERO** in the SQUARE ROOT output mode.

- Low cut mode "LINEAR"      • Low cut mode "ZERO"

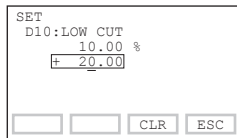
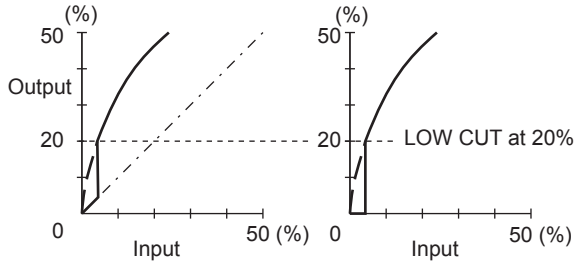

Set 20.  
Press the **ENTER** key twice to enter the setting.

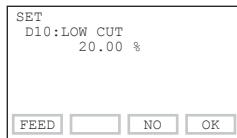

Press the **F4** (OK) key.  
Next, the [D11: LOW CUT MODE] setting panel is displayed.

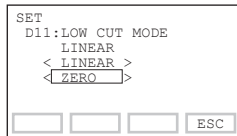

Use the **▲** or **▼** key to select **ZERO**.  
Press the **ENTER** key twice to enter the setting.

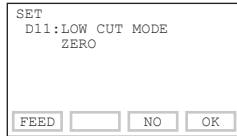

Press the **F4** (OK) key.

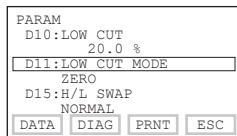

F0318.ai

The low cut point has hysteresis so that the output around the point is behaved as below figure.

<Example>

Output mode: Linear

Low cut mode: Zero

Low cut: 20.00%

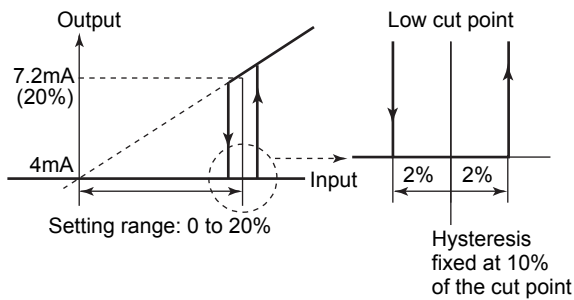

F0319.ai

### (6) Integral Indicator Scale Setup

The following five displays are available for integral indicators: input pressure\*1, % of range, user set scale, input static pressure, and % of static pressure range\*1. A cycle of up to four displays can be shown by assigning variables to the parameters I10 to I13: DISP OUT1 to DISP OUT4.

Available displays	Description and related parameters
Input pressure (PRES) 	Indicates values of input pressure with the indication limits -32000 to 32000.  A11: PRES 456 kPa
% of range (PRES %) 	Indicates input pressure in -2.5 to 110% range depending on the measuring range (C21, C22).  A10: OUTPUT 45.6 %
User set scale (ENGR. PRES) 	Indicates values depending on the engineering range (I33, I34) with the unit (I30).  A16: ENGR. OUTPUT 20.5 m <sup>3</sup> /min A17: ENGR. EXP ×100
Input static pressure (SP)*1 	Indicates input static pressure with the indication limits -32000 to 32000. Reference pressure is factory-set in absolute.  A21: SP 4.000 MPa
% of static pressure range (SP %)*1 	Indicates input static pressure in -10 to 110% range depending on the measuring range (D33, D34).  A20: SP % 52.6 %

F0320.ai

\*1: Available for differential pressure transmitter.



See (a.) through (d.) for each setting procedure.

**a. Display Selection (I10: DISP OUT1)**

Select the variable for the parameter I10: DISP OUT1 to display on the integral indicator.

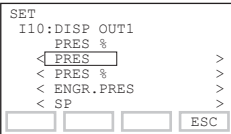
- Example: Change the integral indicator scale from % of range to input pressure display.



Use the  or  key to select **PRES**.

Press the  key twice to enter the setting.

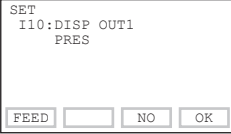

Press the  (OK) key.

F0321.ai

**b. Cyclic Display (I11: DISP OUT2, I12: DISP OUT3, and I13: DISP OUT4)**

In addition to the display set at I10: DISP OUT1, displays can be set at I11: DISP OUT2, I12: DISP OUT3, and I13: DISP OUT4 for cyclic display in the order of the parameter number.

**c. User Setting of Engineering Unit and Scale (I30: ENGR.UNIT, I31: EASY EU SET, I33: ENGR.LRV, and I34: ENGR.URV)**

These parameters allow the entry of the engineering units and scale to be displayed. The engineering unit can be selected from the parameter I31: EASY EU SET as listed below. Alternately, up to eight alphanumeric, spaces, and a slash “/” can be input on keypad at I30: ENGR.UNIT; only first six are displayed on the integral indicator.

Select the unit from the list of I31: EASY EU SET.

kPa	ftH2O	NI/min
MPa	gf/cm2	Nm3/h
mbar	kgf/cm2	Nm3/min
bar	kg/cm2G	ACFH
psi	kg/cm2A	ACFM
psia	atm	SCFH
mmH2O	kg/h	SCFM
mmHg	t/h	GPH
mmHgA	m3/h	GPM
mmAq	m3/min	m
mmWG	l/h	mm
Torr	l/min	in
inH2O	kl/h	ft
inHg	kl/min	kg/m3
inHgA	NI/h	g/cm3

Follow the procedure below to change the settings.

- Example: Set an engineering unit **M**.

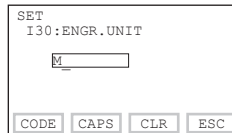

Set **M**.

Press the  key twice to enter the setting.

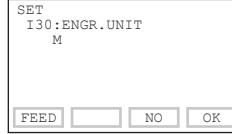

Press the  (OK) key.

F0322.ai

Note that following symbols are not available.

. - , + \* ) ( ' & % \$ # " !

The transmitter integral indicator shows “-----” when these are entered.

- Example: Set lower range value (LRV) to **-50** and upper range value (URV) to **50**.

**Setting LRV**

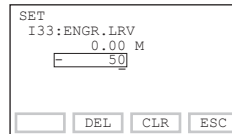

Set **-50**.

Press the  key twice to enter the setting.

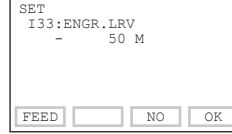

Press the  (OK) key.

**Setting URV**

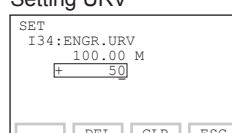

Set **50**.

Press the  key twice to enter the setting.

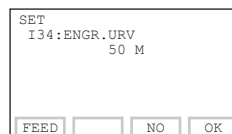

Press the  (OK) key.

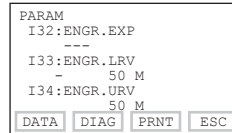

F0323.ai

**d. Setting Static Pressure Unit and Scale**  
**(D30: SP UNIT, D33: SP LRV, and D34: SP URV)**

Static pressure can be displayed in measured input static pressure or in %, independent from the 4-20 mA output signal of measured pressure or differential pressure. These parameters allow the entry of the static pressure unit and scale to be displayed.

Note that the parameter D37: SP SELECT can be used to select either the high or low pressure side of the capsule to monitor the static pressure.

**(7) Unit Setup for Displayed Temperature**  
**(D40: TEMP UNIT)**

When the instrument is shipped, the temperature units are set to **degC**. Follow the procedure below to change this setting. Note that changing the unit here changes the unit for A30: CAPSULE TEMP (capsule temperature) and J45: AMP TEMP (amplifier temperature).

• Example: Change the unit for the temperature display **degC** to **degF**.

```
SET
D40:TEMP UNIT
degC
< degC >
< degF >
< K >
```

Use the or key to select **degF**.

Press the key twice to enter the setting.

Then press the (OK) key.

F0324.ai

**(8) Operation Mode Setup**  
**(D22: REV OUTPUT)**

This parameter allows the direction of the 4-20 mA output to be reversed with respect to input. Follow the procedure below to make this change.

• Example: Change 4 to 20 mA output to 20 to 4 mA output.

```
SET
D22:REV OUTPUT
NORMAL
< NORMAL >
< REVERSE >
```

Use the or key to select **REVERSE**.

Press the key twice to enter the setting.

Then press the (OK) key.

F0325.ai

**(9) Impulse Line Connection Orientation Setup**  
**(D15: H/L SWAP)**

This function reverses the impulse line orientation. Follow the procedure below to make this change.

• Example: Assign the high pressure impulse line connection to the L side of the transmitter.

```
SET
D15:H/L SWAP
NORMAL
< NORMAL >
< REVERSE >
```

Use the or key to select **REVERSE**.

Press the key twice to enter the setting.

Then press the (OK) key.

F0326.ai

**(10) CPU Failure Burnout Direction and Hardware Write Protect  
(D25: BURNOUT)**

There are two slide switches on the CPU assembly board. One sets the burnout direction at CPU failure, and the other sets a write protection function which disables parameter changes through the use of a handheld terminal or some other communication method.

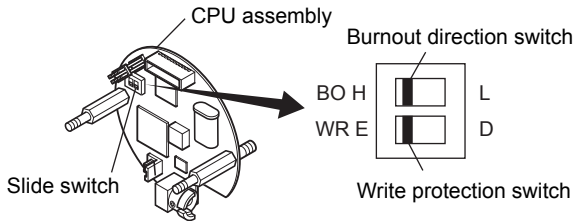

Burnout direction switch (BO)		
Burnout Direction Switch Position	H E	L D
Burnout Direction	HIGH	LOW

Hardware write protection switch (WR)		
Write Protection Switch Position	H E	L D
Write Protection	NO (Write enabled)	YES (Write disabled)

F0327.ai

The parameter D25: BURNOUT displays the status of 4-20 mA DC output if a CPU failure occurs. In case of a failure, communication is disabled.

**Standard specifications**

The burnout direction switch is set to HIGH. If a failure occurs, the transmitter outputs a 110% or higher signal.

**Option code /C1**

The burnout direction switch is set to LOW. If a failure occurs, a -5% or lower output is generated.

- Example: Standard specifications  
 Slide switch position: H
- Example: Option code /C1  
 Slide switch position: L

F0328.ai

**(11) Software Write Protect  
(D55: WRT PROTECT, D56: WRT ENABLE, D57: NEW PASSWORD)**

Transmitter configured data can be saved by the write protect function. Write protect status (D55: WRT PROTECT) is set from **NO** to **YES** when eight alphanumeric characters are entered in the parameter D57: NEW PASSWORD. Accordingly, the transmitter does not accept any parameter changes. When the eight alphanumeric password is entered in the parameter D56: WRT ENABLE, the transmitter accepts parameter changes during a 10 minute period.

To cancel the transmitter for the software write protection completely, use D56: WRT ENABLE to first release the write protect function and then enter eight spaces in the D57: NEW PASSWORD field.

The software write protection does not affect the function of external zero adjustment screw.

To disable the external zero adjustment screw, set the parameter J15: EXT ZERO ADJ to INHIBIT before activating the software write protection.

**a. Setting Password (D57: NEW PASSWORD)**

- Example: Set the password to 1234ABCD.

Enter **1234ABCD**. Press the **ENTER** key twice to enter the setting.

Press the **F4** (OK) key. Then status of parameter D55: WRT PROTECT becomes YES.

F0329.ai

**b. Entering Password to Enable Parameter Change (D56: WRT ENABLE)**

- Example: Enter the password of 1234ABCD.

Enter the password. Press the **ENTER** key twice to enter the setting.

Press the **F4** (OK) key. Parameter changes are available for 10 minutes.

F0330.ai

**c. Releasing Password  
(D57: NEW PASSWORD)**

To release the password, enter eight spaces at D57: NEW PASSWORD during the period that the parameter change is possible.

**d. Software Seal (D58: SOFTWR SEAL)**

When you lose the password that has been registered, it is possible to release the write protect function by using general password. Contact Yokogawa about the general password. When the password is used, the status shown in the parameter D58: SOFTWR SEAL is changed from **KEEP** to **BREAK**. The status returns to **KEEP** by entering a newly set password at D56: WRT ENABLE.

**(12) Output Status Setup when a Hardware Error Occurs  
(D26: ERROR OUT)**

This parameter allows the setting of the output status when a hardware error occurs. The following selections are available.

- (a) BURNOUT DIR; Outputs the corresponding values of 110% or -5% of output signals according to the setting by burnout direction switch (BO) on the CPU board.
- (b) HOLD; Outputs the last value held before the error occurred.

Note: A hardware error means CAP.ERR of AL.01 or AMP.ERR of AL.02 which are shown in table 4.1 Alarm Message Summary.

• Example: Set the output status to **HOLD** when a hardware error occurs.

```

SET
D26:ERROR OUT
  BURNOUT DIR
< BURNOUT DIR >
<[HOLD] >
    
```

Use the  or  key to select **HOLD**.

Press the  key twice to enter the setting.

Then press the  (OK) key.

F0331.ai

**(13) Bi-directional Flow Measurement Setup**

**(E30: BI DIRE MODE)**

- (a) This parameter enables selection of 50% output at an input of 0 kPa. Procedure is shown in the figure below.
- (b) Combining this with **C40: OUTPUT MODE** provides a square root output computed independently for 0% to 50% output and for 50% to 100% output.

• Example: If measurement range is 0 to 10 kPa (LRV=0 kPa, URV=10 kPa)

```

SET
E30:BI DIRE MODE
  OFF
< OFF >
< ON >
    
```

Use the  or  key to select **ON**.

Press the  key twice to enter the setting.

Then press the  (OK) key.

The measurement range changes to -10 to 0 to 10 kPa (output 0% to 50% to 100%).

Note that **C21: PRES LRV** and **C22: PRES URV** are not changed.

F0332.ai

- Output mode "LINEAR"

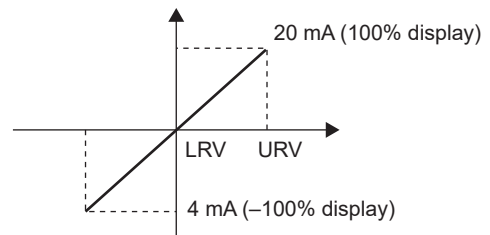

- Output mode "SQUARE ROOT"

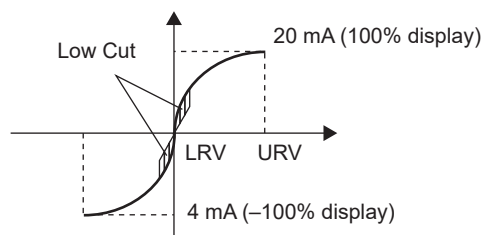

F0333.ai

(14) Range Change while Applying Actual Inputs

(H10: AUTO P LRV, H11: AUTO P URV)

This feature allows the lower and upper range values to be set up automatically with the actual input applied. If the lower and upper range values are set, C21: PRES LRV and C22: PRES URV are changed at the same time.

Follow the procedure in the figure below. The measurement span is determined by the upper and lower range values. Changing the lower range value results in the upper range value changing automatically, keeping the span constant.

- Example 1: When changing the lower range value to 0.5 kPa for the present setting of 0 to 30 kPa, take the following action with input pressure of 0.5 kPa applied.

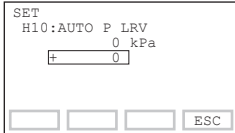

Press the **ENTER** key twice.  
The lower range value is changed to 0.5 kPa.

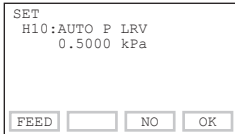

Press the **F4** (OK) key.

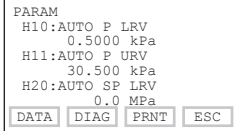

The upper range value is changed keeping the span constant.  
Parameters **C21** and **C22** are changed at the same time.

F0334.ai

Note that changing the upper range value does not cause the lower range value to change but does change the span.

- Example 2: When the upper range value is to be changed to 10 kPa with the present setting of 0 to 30 kPa, take the following action with an input pressure of 10 kPa applied.

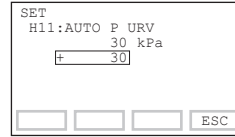

Press the **ENTER** key twice.  
The upper range value is changed to 10 kPa.

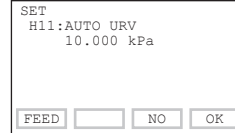

Press the **F4** (OK) key.

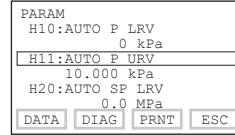

The lower range value is not changed, so the span changes.  
Parameter **C22** is changed at the same time.

F0335.ai

(15) Sensor Trim

Each transmitter is factory characterized. Factory characterization is the process of comparing a known pressure input with the output of each transmitter sensor module over the entire pressure and temperature operating range. During the characterization process, this comparison information is stored in the transmitter EEPROM. In operation, the transmitter uses this factory-stored curve to produce a process variable output (PV), in engineering units, dependent on the pressure input.

The sensor trim procedure allows you to adjust for local conditions, changing how the transmitter calculates process variables. There are two ways to trim the sensor: a zero trim and a full sensor trim. A zero trim is a one-point adjustment typically used to compensate for mounting position effects or zero shifts caused by static pressure. A full sensor trim is a two-point process, in which two accurate end-point pressures are applied (equal to or greater than the range values), and all output is linearized between them.

**a. Zero Trim (J11: P ZERO ADJ, J15: P ZERO DEV, J55: EXT ZERO ADJ)**

The transmitter supports several adjustment methods. Select the method best suited for the conditions of your application.

Adjustment Method	Description
Using the BT200	<b>Set the present input to 0%.</b> Adjust for 0% output at input level of 0%.
	<b>Adjust output to the reference value obtained using other means.</b> If the input level cannot easily be made 0% (because of tank level, etc.), adjust output to the reference value obtained using other means, such as a sight glass.
Using the external zero-adjustment screw	Adjust zero point using the zero-adjustment screw on the transmitter. This permits zero adjustment without using the BT200. Accurately adjust the output current to 4 mA DC or other target output value using an ammeter that accurately reads output currents.

When using BT200, the output signal can be adjusted either in % or pressure unit. The unit can be selected by the parameter J09: ADJ UNIT. Output signal can be changed by displaying parameter A10: OUTPUT for % or J10: OUTPUT for pressure unit.

This section describes the zero adjustment procedure by using the pressure unit.

**a-1. Zeroing**

Setting the parameter J11: P ZERO ADJ carries out the zero adjustment and automatically sets the applied "0" input values to the transmitter's output value of zero, keeping the span constant. Use this setting when the LRV is known to be 0 kPa.

A11: PRES  
0.03585 kPa

Transmitter measures pressure of 0.03585 kPa.

SET  
J11: P ZERO ADJ  
0.00000 kPa  
+ 0

A pressure of 0 kPa is applied. Press the **ENTER** key twice after the pressure has become stable.

SET  
J11: P ZERO ADJ  
0.00000 kPa

Zero adjustment is completed. Press the **F4** (OK) key.

A11: PRES  
0.00000 kPa

Transmitter measures pressure of 0.00000 kPa.

F0336.ai

**a-2. Level Adjustment**

The zero adjustment by the parameter J11: P ZERO ADJ calibrates the transmitter output corresponding to the actual tank level. To perform this adjustment, first use a glass gauge or the like to determine the actual tank level, then enter the correct data as shown below.

DPharp span: 0 to 25.00 kPa  
Actual level: 13.50 kPa  
Transmitter output: 13.83 kPa

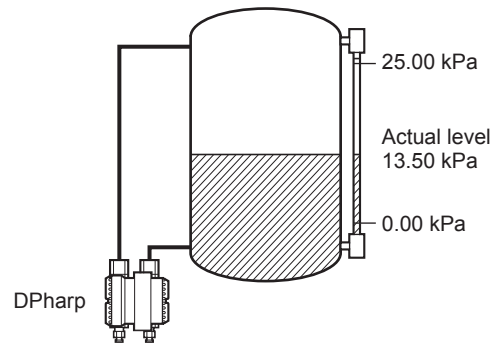

F0337.ai

A11: PRES  
13.83 kPa

Transmitter measures present pressure of 13.83 kPa.

SET  
J11: P ZERO ADJ  
0.00000 kPa  
+ 045.0  
+ 13.5

Enter the present actual level, 13.5 kPa. Press the **ENTER** key twice.

A11: PRES  
13.5000 kPa

The measured pressure is changed to 13.5 kPa.

F0338.ai



**a-3. Using External Zero-adjustment Screw**

This method permits zero adjustment without the BT200. Use a slotted screwdriver to turn the zero-adjustment screw. See the hardware manual for details.

Note that the parameter J55: EXT ZERO ADJ must be **ENABLE** to perform this adjustment.



Follow the procedure below to enable or inhibit zero point adjustment from the zero-adjustment screw on the transmitter.

This is set to **ENABLE** when the instrument is shipped. When option code /CK is specified, the parameter is set to "INHIBIT" upon shipment.

• Example: Inhibiting zero adjustment by the external zero-adjustment screw.

```

SET
J55:EXT ZERO ADJ
  ENABLE
< ENABLE >
< INHIBIT >
    
```

Use the  or  key to select **INHIBIT**.

Press the  key twice to enter the setting.

Then press the  (OK) key.

F0339.ai

**b. Full Sensor Trim (J11: P ZERO ADJ, J12: P SPAN ADJ, J15: P ZERO DEV, J16: P SPAN DEV)**

Full sensor trim is carried out with a series of the procedure of J11: P ZERO ADJ and J12: P SPAN ADJ. Also, you can manually perform the trimming procedure by using J15: P ZERO DEV and J16: P SPAN DEV.

The full sensor trim is a two-point adjustment, and the lower point adjustment should always be performed before the upper point adjustment in order to maintain the pitch between the zero and 100% points within the calibration range.

In the manual method, the reference pressure should also be applied to the transmitter at both lower and upper point of trim ends. Without the reference pressure, J15: P ZERO DEV and J16: P SPAN DEV may not represent the correct value of adjustment point for each.

**b-1. Auto Sensor Trim**

- Example: For the range of 10 to 30 kPa.

Setting a lower point

```

SET
J10:ADJ PRES
  9.94000 kPa
    
```

Transmitter indicates 9.94 kPa as its output when applying a standard pressure of 10 kPa.

```

SET
J11:P ZERO ADJ
  9.94000 kPa
  F 10
    
```

Set 10. After obtaining a stable pressure of 10 kPa, press  key twice.

```

SET
J11:P ZERO ADJ
  10.0000 kPa
    
```

Press the  (OK) key.

```

SET
J10:ADJ PRES
  10.0000 kPa
    
```

Check the output becomes 10 kPa.

Setting an upper point

```

SET
J10:ADJ PRES
  30.1500 kPa
    
```

Transmitter indicates 30.15 kPa as its output when applying a standard pressure of 30 kPa.

```

SET
J12:P SPAN ADJ
  30.1500 kPa
  F 30
    
```

Set 30. After obtaining a stable pressure of 30 kPa, press  key twice.

```

SET
J12:P SPAN ADJ
  30.0000 kPa
    
```

Press the  (OK) key.

```

SET
J10:ADJ PRES
  30.0000 kPa
    
```

Check the output becomes 30 kPa.

F0340.ai



**b-2. Manual Sensor Trim**

- Example: For the range of 10 to 30 kPa.  
 J15: P ZERO DEV = -0.04 kPa  
 J16: P SPAN DEV = -0.03 kPa

Suppose that a standard pressure of 10 kPa is applied and the value of the parameter J10: ADJ PRES is 9.94 kPa. Correct for this output error of 0.06 kPa by adding 0.06 to J15: P ZERO DEV.

$$-0.04 + 0.06 = +0.02$$

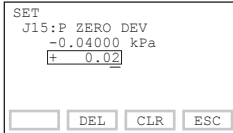

Set **0.02**.  
 Press **ENTER** key twice.

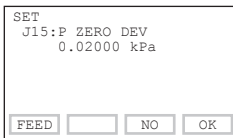

Press the **F4** (OK) key.

Suppose that a standard pressure of 30 kPa is applied and the value of the parameter J10: ADJ PRES is 30.15 kPa. Firstly, obtain the slope error for the span as follows;

$$\begin{aligned} \text{Slope Error} &= \frac{\text{Applied Pres Value} - \text{Measured Pres Value}}{\text{Applied Pres Value}} \times (\text{URV} - \text{LRV}) \\ &= \frac{30.00 - 30.15}{30.00} \times (30.00 - 10.00) = -0.1 \end{aligned}$$

Then correct for this slope error of -0.1 by adding -0.1 to J16: P SPAN DEV.

$$-0.03 + (-0.1) = -0.13$$

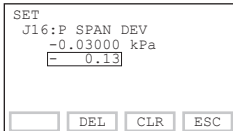

Set **-0.13**.  
 Press **ENTER** key twice.

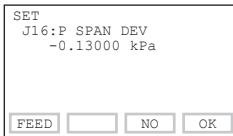

Press the **F4** (OK) key.

F0341.ai

**c. Sensor Trim for Static Pressure**  
**(J21: SP ZERO ADJ, J22: SP SPAN ADJ, J25: SP ZERO DEV, J26: SP SPAN DEV)**

For the transmitters (Except for EJX120A/EJA120E), zeroing and full sensor trim of the static pressure is performed in the same way as with the primary process variable (PV). Note that the static pressure sensor trim should be done only after trimming the PV.

**d. Reset Trim Adjustment to Factory Setting**  
**(J56: CLEAR ADJ)**

Use **PRES** or **SP** of J56: CLEAR ADJ parameter to reset the trim adjustment to the initial calibrated values that were set. When **PRES** is selected to clear the adjustment, the amount of the adjustment by the external zero-adjustment screw is returned to the initial setting as well.

- Example: Reset the trim adjustment of pressure to factory set characterization curve.

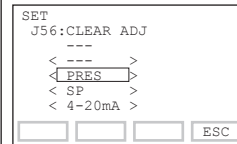

Use the **^** or **v** key to select **PRES**.  
 Press the **ENTER** key twice to enter the setting.

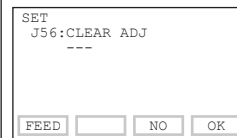

Press the **F4** (OK) key.

F0342.ai

### (16) Test Output Setup (K10: OUTPUT X %)

This feature can be used to output a fixed current for loop checks. The available range for test output depends on the setting at parameters D20: OUT LIMIT (L) and D21: OUT LIMIT (H), whose limit is from 3.6 mA (-2.5%) to 21.6 mA (110%).

- Example: Output 12 mA (50%) fixed current.

SET  
 K10:OUTPUT X %  
 0.00 %  
 050.00

Set **50.00%**.  
 Press the **ENTER** key twice to output a fixed current at 50%.

SET  
 K10:OUTPUT X %  
 50.00% ACTIVE

**ACTIVE** is displayed while this is being executed.  
 Press the **F4** (OK) key to cancel the fixed current output.

F0343.ai



### NOTE

- Fixed current output and DO Test continue for a given holding time, then is released automatically. Even if the BT200 power supply is turned off or the communication cable is disconnected, the test output will continue for that time.

The holding time can be selected from 10 min\*, 30 min, 60 min, 3 hour, 6 hour or 12 hour by the parameter K45: TEST TIME.

\*: Default value.

- Press the **F4** (OK) key to release test output immediately.

### (17) Signal Characterizer

This function is used to compensate the output for non-linear applications. The characterized values are applied to the 4-20 mA output. For the measured pressure, a maximum of nine coordinates can be specified between 0-100%. Perform the coordinate settings while the T10: S. C. ENABLE parameter is **INHIBIT**.

To apply the settings to the output, set the T10: S. C. ENABLE parameter to **ENABLE**.

Note that the transmitter rejects the activation of the function by AL. 60 with the following transmitter's status:

- When the specified coordinates of x and y are not incremental as the input increases.
- When the output mode of the output signal is set as **SQUARE ROOT**; at the same time, the low cut mode is set to **LINEAR**.

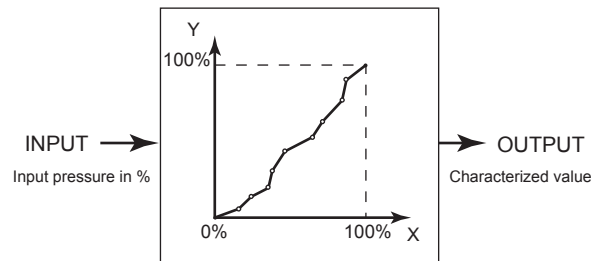

F0344.ai

- Example: Set the number of coordinates on the line graph to 5.

SET  
 T11:NUM OF POINT  
 9  
 3

Set **5**.  
 Press the **ENTER** key twice to enter the setting.

SET  
 T11:NUM OF POINT  
 5

Press the **F4** (OK) key.

F0345.ai

- Example: Set the first coordinates (X1, Y1) as (12, 14) in %.

```

SET
T22:X1
  10.00%
  F 012.00
  [ ] [ ] [CLR] [ESC]
    
```

Set **12** for X1.  
 Press the **ENTER** key twice to enter the setting.  
 Press the **F4** (OK) key.

```

SET
T23:Y1
  10.00%
  F 014.00
  [ ] [ ] [CLR] [ESC]
    
```

Set **14** for Y1.  
 Press the **ENTER** key twice to enter the setting.  
 Press the **F4** (OK) key.

```

PARAM
T21:Y
  0.00%
T22:X1
  12.00%
T23:Y1
  14.00%
[DATA] [DIAG] [PRNT] [ESC]
    
```

F0346.ai

- Example: Set the signal characterizer **ENABLE**.

```

SET
T10:S.C.ENABLE
  INHIBIT
  < INHIBIT >
  < ENABLE >
  [ ] [ ] [ ] [ESC]
    
```

Use the **^** or **v** key to select **ENABLE**.  
 Press the **ENTER** key twice to activate the function.

```

SET
T10:S.C.ENABLE
  ENABLE
  [FEED] [ ] [NO] [OK]
    
```

Press the **F4** (OK) key.

F0347.ai

### (18) Process Alarm

(G10: P AL MODE, G11: P HI.AL VAL, G12: P LO.AL.VAL)

The function is used to display the alarm codes when the input pressure exceeds the specified value within the calibration range. The same is available for the input static pressure and the capsule temperature on the pressure sensor. Refer to table 4.1 Alarm Message Summary for the specific alarm code to be generated.

- Example: Set alarm mode from **OFF** to **HI.AL DETECT**.

```

SET
G10:P AL MODE
  INHIBIT
  < INHIBIT >
  < HI.AL DETECT >
  < LO.AL DETECT >
  < HI/LO.AL DETECT >
  [ ] [ ] [ ] [ESC]
    
```

Use the **^** or **v** key to select **HI. AL DETECT**.  
 Press the **ENTER** key twice to enter the setting.

```

SET
G10:P AL MODE
  HI.AL DETECT
  [FEED] [ ] [NO] [ESC]
    
```

Press the **F4** (OK) key.  
 Alarm code is generated when the output goes beyond the value set at G11: P HI. AL VAL.

F0348.ai

- Example: Set the higher alert value of 75 for alarm generation.

```

SET
G11:P HI.AL VAL
  100.000 kPa
  F 75
  [CODE] [CAPS] [CLR] [ESC]
    
```

Set **75**.  
 Press the **ENTER** key twice to enter the setting.

```

SET
G11:P HI.AL VAL
  75.0000 kPa
  [FEED] [ ] [NO] [OK]
    
```

Press the **F4** (OK) key.  
 Then the alarm code "AL.35 P. HI" is generated when the input pressure goes beyond that value.

F0349.ai

**(19) Status Output (option code AL)**

This feature is used for a transistor output (open collector) of an on/off signal according to the status of high and low alarm limits, which are user-configurable values as shown in (18) Process Alarm. The status output can be assigned as any combination of the high or low limits of the input pressure, input static pressure, or capsule temperature. Please note that the status output function is not a safety related function and it can not be used for safety instrumented system applications.



Execute DO testing by the parameter "K40: DO test" whenever turning on the transmitter or detecting the short interruption in order to check that the alarm contact output is correctly configured.



No status output signal has been defined for a CPU failure or hardware error. Use a 4-20 mA signal to indicate a transmitter's failure.

Example: Status output operation of **ON WHEN AL. DETECT**

- Status output for higher alert value

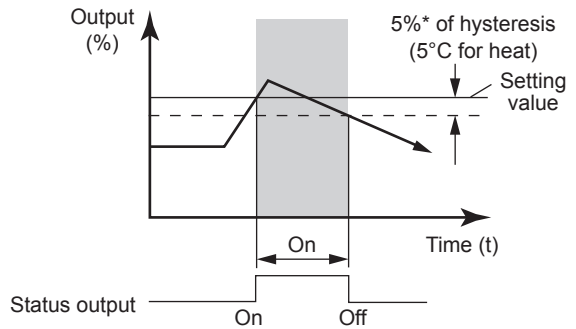

- Status output for lower alert value

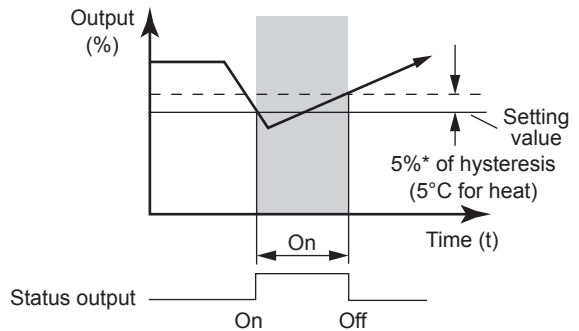

F0351.ai

\*5% of the setting span of differential pressure / pressure.

- Example: Set the status output to output an off signal when the input pressure exceeds 75 kPa with its alert mode of HI. AL DETECT.

```
SET
E50:DO SELECT
  INHIBIT
< INHIBIT >
< PRES >
< SP >
< TEMP >
[ ] [ ] [ ] [ESC]
```

Use the  or  key to select **PRES**.  
Press the  key twice to enter the setting.

```
SET
E50:DO SELECT
PRES
FEED [ ] [NO] [OK]
```

Press the  (OK) key.

```
SET
E51:DO SIG.TYPE
  ON WHEN ALARM
< ON WHEN ALARM >
< OFF WHEN ALARM >
[ ] [ ] [ ] [ESC]
```

Use the  or  key to select **OFF WHEN ALARM**.  
Press the  key twice to enter the setting.

```
SET
E51:DO SIG.TYPE
OFF WHEN ALARM
FEED [ ] [NO] [OK]
```

Press the  (OK) key.

F0350.ai

**(20) Capillary Fill Fluid Density Compensation**

**(E10: T.ZERO CMP, E11: TEMP ZERO)**

For transmitters with diaphragm seals, this function is used to compensate the zero shift caused by the ambient temperature effect on the capillary tubes.

The following equation indicates the relationship between the calculated output value and the compensating constant K (%/°C) with the measured ambient temperature at the capsule module.

$$\text{Compensated output} = \text{output} + K \times T_{\text{amb}}$$

**(1) Temperature Compensation Mode Setup (E10: T. ZERO CMP)**

When using this function, set T. ZERO CMP to ON to enable or OFF to disable. To set to ON, follow the procedure below.

• Example: Set the temperature compensation mode to ON.

```
SET
E10:T.ZERO CMP
  OFF
< OFF >
< ON >
```

Use the  or  key to select ON.

Press the  key twice to enter the setting.

```
SET
E10:T.ZERO CMP
  ON
```

Press the  (OK) key.

F0352.ai

**(2) Zero Shift Compensation Setup (E11: TEMP ZERO)**

Obtain the K compensating value from the equation(1) below.

$$K = - \frac{h \times B}{\text{span}} \times 100 \dots\dots\dots (a)$$

where,

B: Constant value of fill fluid (See Table A.)

span: |URV-LRV|

h: Distance from high pressure side to low pressure side (m)

EJX118A/EJA118E: Distance from high side of diaphragm seal to low side of diaphragm seal.

EJX438A/EJA438E: Distance from diaphragm seal (high side) to position of transmitter (low side).

- EJX118A/EJA118E

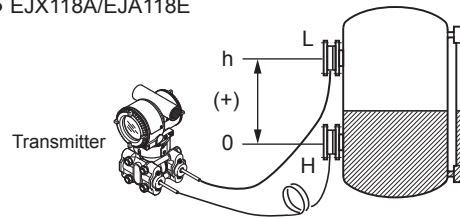

- EJX438A/EJA438E

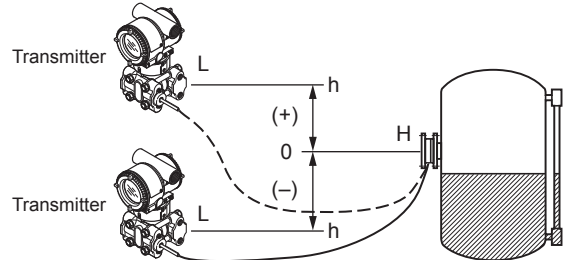

Note: When the transmitter is positioned lower than the diaphragm seal part, the value of "h" must have a negative sign (-).

F0353.ai

• Example: Enter K value obtained from the equation (a). A value having up to 3 decimal places may be specified.

When h=+3 m, Fill fluid code A, span=15 kPa,  
 $K = -(+3) \times 0.00745 \div 15 \times 100 = -0.149$

```
SET
E11:TEMP ZERO
  0.000 %/degC
- 00.149
```

Enter "-0.149."

Press the  key twice to enter the setting.

```
SET
E11:TEMP ZERO
-0.149 %/degC
```

Press the  (OK) key.

F0354.ai

Note 1: The function is performed using a built-in temperature sensor in the transmitter body. The temperature deviation between the transmitter body and capillaries should be minimized to achieve optimal performance of the function.

Note 2: When the span changes, reenter the newly obtained value of K to E11: TEMP ZERO.

**Table A. Constant value [B] of fill fluid**

	Fill fluid code	A, C, 1, 2, 4	B	D	E
Constant value [B]	mmH <sub>2</sub> O	0.76	0.87	1.45	0.75
	kgf/cm <sup>2</sup>	0.000076	0.000087	0.000145	0.000075
	kPa	0.00745	0.00853	0.01422	0.00736
	mBar	0.07453	0.08532	0.14220	0.07355
	atm	0.000074	0.000084	0.000140	0.000073
	inH <sub>2</sub> O	0.02992	0.03425	0.05709	0.02953
	psi	0.00108	0.00124	0.00206	0.00167
	mmHg	0.05592	0.06401	0.10669	0.05518

Note 3: Select the unit of constant value of [B] from the actual unit used for the transmitter in operation.

### (21) Adjustment Information and User Memo Fields

(J50: ADJ WHO, J51: ADJ DATE, J52: ADJ LOC, J53: ADJ DESC, M17 to M19: MEMO1 to MEMO3)

This feature provides four fields for instrument adjustment information at maintenance: inspection date, inspector, location, and description. Also three user memo fields are provided, each holding up to 16 alphanumeric characters.

- Example: Save an inspection date of October 21, 2003.

PARAM  
J50:ADJ WHO

J51:ADJ DATE

J52:ADJ LOC

DATA DIAG PRNT ESC

---

SET  
J51:ADJ DATE  
MM-DD-YYYY  
10-21-2003

CODE CAPS CLR ESC

Set "10-21-2003" in the order of month, day, and year.

Press the **ENTER** key twice to enter the setting.

F0355.ai

### 3.3.2 Display Transmitter Model and Specifications

The BT200 can be used to display the model and specifications of the transmitter.

- Example: View transmitter model name.

MENU  
A:DISPLAY  
B:SENSOR TYPE  
C:BASIC SETUP  
D:AUX SET1  
E:AUX SET2  
G:ALARM SET  
HOME SET ADJ ESC

Press **ENTER**.

↓

PARAM  
B10:MODEL  
EJX110 M  
B11:STYLE NO.  
1.00  
B20:PRES LRL  
- 98.07 kPa

DATA DIAG PRNT ESC

For the associated parameters, see Chapter 5, Parameter Summary.

F0357.ai

## 3.3 Displaying Data Using the BT200

### 3.3.1 Displaying Measured Data

The BT200 can be used to display measured data.

The measured data is updated automatically every seven seconds. In addition, the display can be updated to the present data value at any time by pressing the **F1** (DATA) key. For parameters associated with the display of measured data, see chapter 5 Parameter Summary.

- Example: Display output.

MENU  
A:DISPLAY  
B:SENSOR TYPE  
C:BASIC SETUP  
D:AUX SET1  
E:AUX SET2  
G:ALARM SET  
HOME SET ADJ ESC

PARAM  
A10:OUTPUT  
0.0 %

A11:PRES  
0.0000 kPa

A15:OUTPUT mA  
4.000 mA

DATA DIAG PRNT ESC

Display "A10: OUTPUT."

Data is updated automatically at 7-second intervals.

---

PARAM  
A10:OUTPUT  
0.0 %

A11:PRES  
0.0000 kPa

A15:OUTPUT mA  
4.000 mA

F0356.ai

# 4. Self-diagnostics

## 4.1 Checking for Problems

### 4.1.1 Identifying Problems with BT200

The following four areas can be checked.

- (a) Whether connections are good.
- (b) Whether BT200 was properly operated.
- (c) Whether settings were properly entered.
- (d) History of the errors.

See examples below.

#### • Example 1: Connection errors

```
--WELCOME--
BRAIN TERMINAL
ID: BT200

check connection
push ENTER key

UTIL FEED
```

Press the **ON/OFF** key. When the panel shown on the left appears, press the **ENTER** key. Since communications will be unsuccessful if there is a problem in the connection to the BT200, the display at the left will appear. Recheck the connection. Press the **F4** (OK) key.

```
communication error

ESC
```

F0401.ai

#### • Example 2: Setting entry errors

```
PARAM
01:MODEL
EJX110 M
02:TAG NO.
YOKOGAWA
03:SELF CHECK
ERROR
OK
```

The initial data panel shows the result of current transmitter diagnostics.

```
PARAM
C20:PRES UNIT
kPa
C21:PRES LRV
600 kPa
C22:PRES URV
600 kPa
DATA DIAG PRNT ESC
```

Press the **F2** (DIAG) key in the parameter panel to go to the diagnostics panel (C60: SELF CHECK).

```
DIAG
C60:SELF CHECK
ERROR
ERROR
ILLEGAL LRV
FEED PRNT ESC
```

An error message is displayed when an error occurs in the diagnostics panel.

F0402.ai

#### • Example 3: Checking the history of the errors

```
MENU
J:ADJUST
K:TEST
L:CALIBRATION
M:MEMO
P:RECORD
T:CHARACTERIZR
HOME SET ADJ ESC
```

Connect the BT200 to the transmitter, and call item "P."

```
PARAM
P10:ERROR REC 1
ERROR
P12:ERROR REC 2
ERROR
P14:ERROR REC 3
GOOD
DATA DIAG PRNT ESC
```

P10: "ERROR REC 1" displays the last error.

P12: "ERROR REC 2" displays the error one time before the last error occurred.

P14: "ERROR REC 3" displays the error two times before the last error occurred.

P16: "ERROR REC 4" displays the error three times before the last error occurred.

The history of up to four errors can be stored. When the 5th error has occurred, it is stored in "P10." The error stored in "P16" will be deleted, and then, the error in "P14" will be copied to "P16." In this sequence, the history of the most previously occurred error will be removed from memory.

"GOOD" will be displayed if there was no previous error.

```
SET
P10:ERROR REC 1
ERROR
<ERROR>
<50:P ILLEG LRV>
ESC
```

Select P10: ERROR REC1 and press the **ENTER** key to display the error message.

<(a) SETUP PANEL>

For the details of the messages, see [Table 4.1 Alarm Message Summary](#).

Note 1: Press the **ENTER** key twice in the setup panel (a) to clear all error message (P10 to P16) information.

Note 2: When the error occurs, the self-diagnostic detects errors and records them in two ways depending on the types of errors. The amplifier/capsule failures are recorded immediately after the occurrence, while the minor errors such as warnings of inappropriate parameter settings are periodically recorded at an interval of minimum five minutes to twenty four hours.

Note that the interval extends as the number of access counts to EEPROM increases.

F0403.ai

### 4.1.2 Checking with Integral Indicator



#### NOTE

If an error is detected by running self-diagnostics, an error number is displayed on the integral indicator. If there is more than one error, the error number changes at three-second intervals. See table 4.1 regarding the alarm codes.

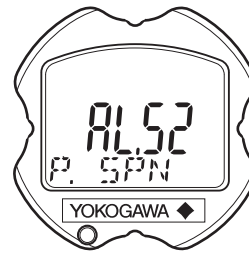

F0404.ai

Figure 4.1 Integral Indicator

## 4.2 Alarms and Countermeasures

Table 4.1 Alarm Message Summary

Indicator	BT200 display	Cause	Output operation during error	Countermeasure
None	GOOD			
AL. 01 CAP. ERR	01: P-SENSOR ERR	Sensor problem.	Outputs the signal (Hi or Low) set with parameter D26. [Status output: undefined]	Replace capsule when error keep appearing even after restart.
	01: CT-SENSOR ERR	Capsule temperature sensor problem.		Replace capsule.
	01: C-EEPROM ERR	Capsule EEPROM problem.		
AL. 02 AMP. ERR	02: AT-SENSOR ERR	Amplifier temperature sensor problem.		Replace amplifier.
	02: A-EEPROM ERR	Amplifier EEPROM problem.		
	02: CPU BOARD ERR	Amplifier problem.		
AL. 10 PRESS	10: P OVER SPEC	Input is outside measurement range limit of capsule.	Outputs upper range limit (URL) or lower range limit (LRL).	Check input or replace capsule when necessary.
AL. 11 ST. PRSS	11: SP OVER SPEC	Static pressure exceeds limit.	Continues to operate and output.	
AL. 12 CAP. TMP	12: CT OVER SPEC	Capsule temperature is outside range (-50 to 130°C).		Use heat insulation or make lagging to keep temperature within range.
AL. 13 AMP. TMP	13: AT OVER SPEC	Amplifier temperature is outside range (-50 to 95°C).		
AL. 30 RANGE	30: P OVER RANGE	Output is outside upper or lower range limit value.	Outputs upper range value (URV) or lower range value (LRV).	Check input and range setting, and change them as needed.
AL. 31 SP. RNG	31: SP OVER RANGE	Static pressure exceeds specified range.	Continues to operate and output.	
AL. 35 P. HI	35: P HIGH ALARM	Input pressure exceeds specified threshold.		Check input.
AL. 36 P. LO	36: P LOW ALARM			
AL. 37 SP. HI	37: SP HIGH ALARM	Input static pressure exceeds specified threshold.		
AL. 38 SP. LO	38: SP LOW ALARM			
AL. 39 TMP. HI	39: CT HIGH ALARM	Detected temperature exceeds specified threshold.		Check capsule temperature.
AL. 40 TMP. LO	40: CT LOW ALARM			



Indicator	BT200 display	Cause	Output operation during error	Countermeasure
AL. 50 P. LRV	50: P ILLEG LRV	Specified value is outside of setting range.	Holds output immediately before error occurred.	Check settings and change them as needed.
AL. 51 P. URV	51: P ILLEG URV			
AL. 52 P. SPN	52: P ILLEG SPAN			
AL. 53 P. ADJ	53: P SPAN ADJ		Continues to operate and output.	Adjust settings and change them as needed.
AL. 54 SP. RNG	53: P ZERO ADJ		Continues to operate and output.	Check settings and change them as needed.
	54: SP ILLEG LRV			
	54: SP ILLEG URV			
AL. 55 SP. ADJ	54: SP ILLEG SPAN		Continues to operate and output.	Adjust settings and change them as needed.
	55: SP SPAN ADJ			
AL. 60 SC. CFG	60: SC CONFIG ERR		Specified values or settings do not meet the conditions.	Continues to operate and output.
AL. 79 OV. DISP	—	Displayed value exceeds limit.	Continues to operate and output.	

# 5. Parameter Summary

Instruments to which applicable:

F: Differential pressure transmitters

P: Absolute and gauge pressure transmitters

L: Flange mounted differential pressure transmitters

No.	Parameter name	Item	*1 R/W	Content	Default value	Applicable model			Upload data
						F	P	L	
01	MODEL	Model	R		EJX (for EJX series) EJA (for EJA series)	○	○	○	—
02	TAG No.	Tag number	R		As specified	○	○	○	—
03	SELF CHECK	Self-diagnostics	R		GOOD	○	○	○	—
A	DISPLAY	Measured data display							
A10	OUTPUT	Output (in %)	R	-2.5 to 110%		○	○	○	—
A11	PRES	Measured pressure after zero adjustment	R	Unit specified in C20		○	○	○	—
A15	OUTPUT mA	Output current	R	3.600 to 21.600 mA		○	○	○	—
A16	ENGR. OUTPUT	User scaled value	R	Unit specified in I30		○	○	○	—
A17	ENGR. EXP	Exponents	R	Unit specified in I32		○	○	○	—
A20	SP %	Static pressure (in %)	R	-10 to 110%		○	—	○	—
A21	SP	Static pressure after zero adjustment	R	Unit specified in D30		○	—	○	—
A30	CAPSULE TEMP	Capsule temperature	R	Unit specified in D40		○	○	○	—
A60	SELF CHECK	Self-diagnostics	R	Refer to Table 4.1 Alarm Message Summary		○	○	○	—
B	SENSOR TYPE	Sensor type							
B10	MODEL	Model and capsule type	R	Model and capsule type		○	○	○	—
B11	STYLE NO.	Style number	R	Style number of product		○	○	○	—
B20	PRES LRL	Lower range limit	R	Unit specified in C20		○	○	○	—
B21	PRES URL	Upper range limit	R	Unit specified in C20		○	○	○	—
B22	P MIN SPAN	Minimum span	R	Unit specified in C20		○	○	○	—
B30	SP LRL	Lower range limit for static pressure	R	Unit specified in D30		○	—	○	—
B31	SP URL	Upper range limit for static pressure	R	Unit specified in D30		○	—	○	—
B32	SP MIN SPAN	Minimum span for static pressure	R	Unit specified in D30		○	—	○	—
B60	SELF CHECK	Self-diagnostics	R	See A60		○	○	○	—
C	BASIC SETUP	Setting data							
C10	TAG NO.	Tag number	W	16 alphanumeric characters	As specified	○	○	○	○
C20	PRES UNIT	Measurement range unit	W	mmH <sub>2</sub> O, mmAq, mmWG, mmHg, Torr, kPa, MPa, mbar, bar, gf/cm <sup>2</sup> , kgf/cm <sup>2</sup> , inH <sub>2</sub> O, inHg, ftH <sub>2</sub> O, psi, atm, Pa, hPa	kPa	○	○	○	○
C21	PRES LRV	Lower range value	W	-32000 to 32000 within measurement range	As specified	○	○	○	○
C22	PRES URV	Upper range value	W	-32000 to 32000 within measurement range	As specified	○	○	○	○
C23	PRES POINT	Decimal place	W	0 to 4	2	○	○	○	○
C30	AMP DAMPING	Damping time constant at amplifier	W	0.50(0.00) to 100.00 seconds, see D50	2.00 seconds or as specified	○	○	○	○
C40	OUTPUT MODE	Output mode	W	LINEAR or SUQARE ROOT	LINEAR or as specified	○	○	○	○
C60	SELF CHECK	Self-diagnostics	R	See A60		○	○	○	—

\*1: R/W: R = Read only, W = Read & Write

\*2: The default value shows MWP (Maximum working pressure) of the capsule.

Since the working pressure limit varies according to the Model, refer to the General Specifications section in each user's manual.

\*3: This function cannot be used for V capsule.

\*4: This parameter may contain the adjustment value at factory upon shipment. If executing J56 "CLEAR ADJ", the value of J15, J16, J40 and J41 will become 0, and value of J11 and J12 will become the value of PRES LRV and PRES URV respectively.

\*5: "INHIBIT" when /CK is specified.

No.	Parameter name	Item	*1 R/W	Content	Default value	Applicable model			Upload data
						F	P	L	
D	AUX SET 1	Auxiliary setting data 1							
D10	LOW CUT	Low cut	W	0.00 to 20.00%	10.00%	○	○	○	○
D11	LOW CUT MODE	Low cut mode	W	LINEAR or ZERO	LINEAR	○	○	○	○
D15	H/L SWAP	Impulse piping accessing direction <sup>*3</sup>	W	NORMAL or REVERSE	NORMAL	○	—	○	○
D16	H2O UNIT SEL	H2O unit select	W	@4degC or @20degC (68.0F)	@4degC	○	○	○	○
D20	OUT LIMIT (L)	Low side output limiter	W	-2.50 to 110.00%	-2.50%	○	○	○	○
D21	OUT LIMIT (H)	High side output limiter	W	-2.50 to 110.00%	110%	○	○	○	○
D22	REV OUTPUT	Output reversal	W	NORMAL or REVERSE	NORMAL	○	○	○	○
D25	BURNOUT	CPU error	R	HIGH or LOW		○	○	○	—
D26	ERROR OUT	Hardware error	W	BURNOUT DIR or HOLD	BURNOUT DIR	○	○	○	○
D30	SP UNIT	Static pressure unit	W	See C20	MPa	○	—	○	○
D31	SP A/G SLCT	Gauge/Abs select for static pressure	W	GAUGE or ABSOLUTE	ABSOLUTE	○	—	○	○
D32	ATM. PRESS	Coefficient for given gauge pressure	W	Unit specified in D30	0.10133 MPa	○	—	○	○
D33	SP LRV	Lower limit of static pressure	W	-32000 to 32000 within measurement range	0.0 MPa	○	—	○	○
D34	SP URV	Upper limit of static pressure <sup>*2</sup>	W	-32000 to 32000 within measurement range		○	—	○	○
D35	SP POINT	Decimal place of static pressure	W	0 to 4	1	○	—	○	○
D36	SP DAMPING	Damping time constant of SP	W	0.00 to 100.00 seconds	2.00 seconds	○	—	○	○
D37	SP SELECT	H/L select for static pressure	W	HIGH or LOW	HIGH	○	—	○	○
D40	TEMP UNIT	Temperature setting unit	W	degC, degF, or K	degC	○	○	○	○
D50	QUICK RESP	Quick response	W	OFF or ON (enable 0.00 to 0.50 seconds at C30)	OFF	○	○	○	○
D55	WRT PROTECT	Write protect indicator	R	NO or YES	NO	○	○	○	—
D56	WRT ENABLE	Write protect release	W	8 alphanumeric characters	None	○	○	○	—
D57	NEW PASSWORD	User set password for write protect	W	8 alphanumeric characters	None	○	○	○	—
D58	SOFTWR SEAL	Software seal	R	BREAK or KEEP	KEEP	○	○	○	—
D60	SELF CHECK	Self-diagnostics	R	See A60		○	○	○	—
E	AUX SET 2	Auxiliary setting data 2							
E10	T. ZERO CMP	Temperature compensation mode	W	OFF or ON	OFF	○	○	○	—
E11	TEMP ZERO	Zero shift compensation	W	-99.999 to 99.999%/degC	0.000%/degC	○	○	○	—
E30	BI DIRE MODE	Bidirectional mode	W	OFF or ON	OFF	○	○	○	—
E50	DO SELECT	Contact output select	W	INHIBIT, PRES, SP, TEMP, PRES/SP, PRES/TEMP, SP/TEMP, or PRES/SP/TEMP	INHIBIT	○	○	○	—
E51	DO SIG. TYPE	Signal type select	W	OFF WHEN ALARM or ON WHEN ALARM	ON WHEN ALARM	○	○	○	—
E52	D OUTPUT	Contact output	R	OFF or ON	OFF	○	○	○	—
E60	SELF CHECK	Self-diagnostics	R	See A60		○	○	○	—

\*1: R/W: R = Read only, W = Read & Write

\*2: The default value shows MWP (Maximum working pressure) of the capsule.

Since the working pressure limit varies according to the Model, refer to the General Specifications section in each user's manual.

\*3: This function cannot be used for V capsule.

\*4: This parameter may contain the adjustment value at factory upon shipment. If executing J56 "CLEAR ADJ", the value of J15, J16, J40 and J41 will become 0, and value of J11 and J12 will become the value of PRES LRV and PRES URV respectively.

\*5: "INHIBIT" when /CK is specified.

No.	Parameter name	Item	*1 R/W	Content	Default value	Applicable model			Upload data
						F	P	L	
G	ALARM SET	Alarm setting							
G10	P AL MODE	Alert mode	W	INHIBIT, HI. AL DETECT, LO. AL DETECT, or HI/LO. AL DETECT	INHIBIT	○	○	○	—
G11	P HI. AL VAL	High side alert value	W	-32000 to 32000, unit specified in C20	100.000 kPa	○	○	○	—
G12	P LO. AL VAL	Low side alert value	W	-32000 to 32000, unit specified in C20	-100.000 kPa	○	○	○	—
G20	SP AL MODE	Static pressure alert mode	W	INHIBIT, HI. AL DETECT, LO. AL DETECT, or HI/LO. AL DETECT	INHIBIT	○	—	○	—
G21	SP HI. AL VAL	High side alert value of SP*2	W	-32000 to 32000, unit specified in D30		○	—	○	—
G22	SP LO. AL VAL	Low side alert value of SP	W	-32000 to 32000, unit specified in D30	0.00000 MPa	○	—	○	—
G30	T AL MODE	Temperature alert mode	W	INHIBIT, HI. AL DETECT, LO. AL DETECT, or HI/LO. AL DETECT	INHIBIT	○	○	○	—
G31	T HI. AL VAL	High side alert value of temperature	W	-50 to 130	120 degC	○	○	○	—
G32	T LO. AL VAL	Low side alert value of temperature	W	-50 to 130	-40 degC	○	○	○	—
G50	AUTO RECOVER	Auto-recover from sensor error	W	OFF or ON	ON	○	○	○	—
G60	SELF CHECK	Self-diagnostics	R	See A60		○	○	○	—
H	AUTO SET	Automatic setup							
H10	AUTO P LRV	Lower range value auto setup	W	-32000 to 32000, unit specified in C20	As specified	○	○	○	—
H11	AUTO P URV	Upper range value auto setup	W	-32000 to 32000, unit specified in C20	As specified	○	○	○	—
H20	AUTO SP LRV	SP lower range value auto setup	W	-32000 to 32000, unit specified in D30	0.00000 MPa	○	—	○	—
H21	AUTO SP URV	SP upper range value auto setup*2	W	-32000 to 32000, unit specified in D30		○	—	○	—
H60	SELF CHECK	Self-diagnostics	R	See A60		○	○	○	—
I	DISP SET	Display setting							
I10	DISP OUT1	LCD output 1	W	PRES, PRES %, ENGR. PRES, SP, or SP %	PRES %	○	○	○	○
I11	DISP OUT2	LCD output 2	W	PRES, PRES %, ENGR. PRES, SP, SP %, or ---	---	○	○	○	○
I12	DISP OUT3	LCD output 3	W	See I11	---	○	○	○	○
I13	DISP OUT4	LCD output 4	W	See I11	---	○	○	○	○
I20	P DISP MODE	% display mode	W	LINEAR or SQUARE ROOT	LINEAR	○	○	○	○
I21	PRES % RESO	% display resolution	W	NORMAL or HIGH RESOLUTION	NORMAL	○	○	○	○
I30	ENGR. UNIT	User set engineering unit	W	8 alphanumeric characters		○	○	○	○
I31	EASY EU SET	Engineering unit select	W			○	○	○	—
I32	ENGR. EXP	Exponents	W	---, ×10, ×100, ×1000	---	○	○	○	○
I33	ENGR. LRV	User set lower range limit	W	-32000 to 32000, unit specified in I30	0.00	○	○	○	○
I34	ENGR. URV	User set upper range limit	W	-32000 to 32000, unit specified in I30	100.00	○	○	○	○
I35	ENGR. POINT	Decimal place of user set	W	0 to 4	1	○	○	○	○
I40	BAR INDICATR	Bar indicator	W	OFF or ON	ON	○	○	○	○
I41	POWER ON INF	Display when powering on	W	OFF or ON	ON	○	○	○	—
I60	SELF CHECK	Self-diagnostics	R	See A60		○	○	○	—

\*1: R/W: R = Read only, W = Read & Write

\*2: The default value shows MWP (Maximum working pressure) of the capsule.

Since the working pressure limit varies according to the Model, refer to the General Specifications section in each user's manual.

\*3: This function cannot be used for V capsule.

\*4: This parameter may contain the adjustment value at factory upon shipment. If executing J56 "CLEAR ADJ", the value of J15, J16, J40 and J41 will become 0, and value of J11 and J12 will become the value of PRES LRV and PRES URV respectively.

\*5: "INHIBIT" when /CK is specified.

No.	Parameter name	Item	*1 R/W	Content	Default value	Applicable model			Upload data
						F	P	L	
J	ADJUST	Adjusting data							
J09	ADJ UNIT	Pressure adjusting unit select	W	% or PRES UNIT	PRES UNIT	<input type="radio"/>	<input type="radio"/>	<input type="radio"/>	—
J10	ADJ PRES	Adjustment reference pressure	R	Unit specified in J09		<input type="radio"/>	<input type="radio"/>	<input type="radio"/>	—
J11	P ZERO ADJ	Automatic zero adjustment	W	-32000 to 32000, unit specified in J09	0.00000 kPa*4	<input type="radio"/>	<input type="radio"/>	<input type="radio"/>	—
J12	P SPAN ADJ	Automatic span adjustment	W	-32000 to 32000, unit specified in J09	100.000 kPa*4	<input type="radio"/>	<input type="radio"/>	<input type="radio"/>	—
J15	P ZERO DEV	Manual zero adjustment	W	-32000 to 32000, unit specified in J09	0 kPa*4	<input type="radio"/>	<input type="radio"/>	<input type="radio"/>	—
J16	P SPAN DEV	Manual span adjustment	W	-32000 to 32000, unit specified in J09	0 kPa*4	<input type="radio"/>	<input type="radio"/>	<input type="radio"/>	—
J20	ADJ SP	Adjustment reference pressure of SP	R	Unit specified in J09		<input type="radio"/>	—	<input type="radio"/>	—
J21	SP ZERO ADJ	Automatic SP zero adjustment	W	-32000 to 32000, unit specified in J09	0.00000 MPa	<input type="radio"/>	—	<input type="radio"/>	—
J22	SP SPAN ADJ	Automatic SP span adjustment*2	W	-32000 to 32000, unit specified in J09		<input type="radio"/>	—	<input type="radio"/>	—
J25	SP ZERO DEV	Manual SP zero adjustment	W	-32000 to 32000, unit specified in J09	0.00000 MPa	<input type="radio"/>	—	<input type="radio"/>	—
J26	SP SPAN DEV	Manual SP span adjustment	W	-32000 to 32000, unit specified in J09	0.00000 MPa	<input type="radio"/>	—	<input type="radio"/>	—
J40	OUTPUT 4mA	4 mA adjustment	W	-10.000 to 10.000%	0.000%*4	<input type="radio"/>	<input type="radio"/>	<input type="radio"/>	—
J41	OUTPUT 20mA	20 mA adjustment	W	-10.000 to 10.000%	0.000%*4	<input type="radio"/>	<input type="radio"/>	<input type="radio"/>	—
J45	AMP TEMP	Amplifier temperature	R	Unit specified D40	0 degC	<input type="radio"/>	<input type="radio"/>	<input type="radio"/>	—
J50	ADJ WHO	Adjustment information	W	8 alphanumeric characters		<input type="radio"/>	<input type="radio"/>	<input type="radio"/>	—
J51	ADJ DATE	Adjustment information	W	16 alphanumeric characters		<input type="radio"/>	<input type="radio"/>	<input type="radio"/>	—
J52	ADJ LOC	Adjustment information	W	8 alphanumeric characters		<input type="radio"/>	<input type="radio"/>	<input type="radio"/>	—
J53	ADJ DESC	Adjustment information	W	16 alphanumeric characters		<input type="radio"/>	<input type="radio"/>	<input type="radio"/>	—
J55	EXT ZERO ADJ	External zeroing permission	W	INHIBIT or ENABLE	ENABLE*5	<input type="radio"/>	<input type="radio"/>	<input type="radio"/>	—
J56	CLEAR ADJ	Clear adjustment	W	---, PRES, SP, 4-20mA, or ALL	---	<input type="radio"/>	<input type="radio"/>	<input type="radio"/>	—
J60	SELF CHECK	Self-diagnostics	R	See A60		<input type="radio"/>	<input type="radio"/>	<input type="radio"/>	—
K	TEST	Test parameters							
K10	OUTPUT X %	Test output % setting	W	Within a range between D20 and D21	0.00%	<input type="radio"/>	<input type="radio"/>	<input type="radio"/>	—
K40	DO TEST	Test contact output	W	OFF or ON	OFF	<input type="radio"/>	<input type="radio"/>	<input type="radio"/>	—
K45	TEST TIME	“OUTPUT X %” and “DO TEST” duration time selection	W	10 min, 30 min, 60 min, 3 hour, 6 hour, 12 hour	10 min	<input type="radio"/>	<input type="radio"/>	<input type="radio"/>	—
K50	TEST KEY1	Special maintenance parameter	W			<input type="radio"/>	<input type="radio"/>	<input type="radio"/>	—
K51	TEST KEY2	Special maintenance parameter	W			<input type="radio"/>	<input type="radio"/>	<input type="radio"/>	—
K52	TEST KEY3	Special maintenance parameter	W			<input type="radio"/>	<input type="radio"/>	<input type="radio"/>	—
K53	TEST KEY4	Special maintenance parameter	W			<input type="radio"/>	<input type="radio"/>	<input type="radio"/>	—
K60	SELF CHECK	Self-diagnostics	R	See A60		<input type="radio"/>	<input type="radio"/>	<input type="radio"/>	—
M	DEVICE INFO	Device information							
M10	SERIAL NO.	Serial number	R			<input type="radio"/>	<input type="radio"/>	<input type="radio"/>	—
M11	MFTR. DATE	Manufactured date	R			<input type="radio"/>	<input type="radio"/>	<input type="radio"/>	—
M12	EXTRA NO.	Customization number	R			<input type="radio"/>	<input type="radio"/>	<input type="radio"/>	—
M15	SOFT REV	Software revision	R			<input type="radio"/>	<input type="radio"/>	<input type="radio"/>	—
M16	BRAIN REV	BRAIN protocol revision	R			<input type="radio"/>	<input type="radio"/>	<input type="radio"/>	—
M17	MEMO1	Memo	W	16 alphanumeric characters		<input type="radio"/>	<input type="radio"/>	<input type="radio"/>	—
M18	MEMO2	Memo	W	16 alphanumeric characters		<input type="radio"/>	<input type="radio"/>	<input type="radio"/>	—

\*1: R/W: R = Read only, W = Read & Write

\*2: The default value shows MWP (Maximum working pressure) of the capsule.

Since the working pressure limit varies according to the Model, refer to the General Specifications section in each user's manual.

\*3: This function cannot be used for V capsule.

\*4: This parameter may contain the adjustment value at factory upon shipment. If executing J56 “CLEAR ADJ”, the value of J15, J16, J40 and J41 will become 0, and value of J11 and J12 will become the value of PRES LRV and PRES URV respectively.

\*5: “INHIBIT” when /CK is specified.

No.	Parameter name	Item	*1 R/W	Content	Default value	Applicable model			Upload data
						F	P	L	
M19	MEMO3	Memo	W	16 alphanumeric characters		○	○	○	—
M20	ISOL MATL	Capsule material	W			○	○	○	—
M21	FILL FLUID	Fill fluid	W			○	○	○	—
M22	GASKET MATL	Gasket material	W			○	○	○	—
M23	PRO CON MATL	Flange material	W			○	○	○	—
M24	D-VENT MATL	Vent plug material	W			○	○	○	—
M25	PRO CON TYPE	Process connection type	W			○	○	○	—
M26	RS ISOL MATL	Remote seal material	W			○	○	○	—
M27	PRO CON SIZE	Flange size	W			○	○	○	—
M28	NUM RS	Number of remote seal	W			○	○	○	—
M29	RS FILL FLUID	Fill fluid of remote seal	W			○	○	○	—
M30	RS TYPE	Remote seal type	W			○	○	○	—
M50	MS CODE 1	Model and suffix code 1	W			○	○	○	—
M51	MS CODE 2	Model and suffix code 2	W			○	○	○	—
M52	MS CODE 3	Model and suffix code 3	W			○	○	○	—
M53	MS CODE 4	Model and suffix code 4	W			○	○	○	—
M54	MS CODE 5	Model and suffix code 5	W			○	○	○	—
M55	MS CODE 6	Model and suffix code 6	W			○	○	○	—
M60	SELF CHECK	Self-diagnostics	R	See A60		○	○	○	—
P	Record	History of errors							
P10	ERROR REC 1	Last error	W	See A60	GOOD	○	○	○	—
P12	ERROR REC 2	Second recent error	W	See A60	GOOD	○	○	○	—
P14	ERROR REC 3	Third recent error	W	See A60	GOOD	○	○	○	—
P16	ERROR REC 4	Forth recent error	W	See A60	GOOD	○	○	○	—
P60	SELF CHECK	Self-diagnostics	R	See A60		○	○	○	—
T	CHARACTERIZR	Signal characterizer setting							
T10	S. C. ENABLE	Signal characterizer permission	W	INHIBIT or ENABLE	INHIBIT	○	○	○	—
T11	NUM OF POINT	Number of coordinates	W	0 to 9	0	○	○	○	—
T20	X START (FIX)	Start point of X	R	0.00%		○	○	○	—
T21	Y START (FIX)	Start point of Y	R	0.00%		○	○	○	—
T22	X1	Coordinate 1 of X	W	0.00 to 100.00%	10.00	○	○	○	—
T23	Y1	Coordinate 1 of Y	W	0.00 to 100.00%	10.00	○	○	○	—
T24	X2	Coordinate 2 of X	W	0.00 to 100.00%	20.00	○	○	○	—
T25	Y2	Coordinate 2 of Y	W	0.00 to 100.00%	20.00	○	○	○	—
T26	X3	Coordinate 3 of X	W	0.00 to 100.00%	30.00	○	○	○	—
T27	Y3	Coordinate 3 of Y	W	0.00 to 100.00%	30.00	○	○	○	—
T28	X4	Coordinate 4 of X	W	0.00 to 100.00%	40.00	○	○	○	—
T29	Y4	Coordinate 4 of Y	W	0.00 to 100.00%	40.00	○	○	○	—
T30	X5	Coordinate 5 of X	W	0.00 to 100.00%	50.00	○	○	○	—
T31	Y5	Coordinate 5 of Y	W	0.00 to 100.00%	50.00	○	○	○	—
T32	X6	Coordinate 6 of X	W	0.00 to 100.00%	60.00	○	○	○	—
T33	Y6	Coordinate 6 of Y	W	0.00 to 100.00%	60.00	○	○	○	—
T34	X7	Coordinate 7 of X	W	0.00 to 100.00%	70.00	○	○	○	—
T35	Y7	Coordinate 7 of Y	W	0.00 to 100.00%	70.00	○	○	○	—
T36	X8	Coordinate 8 of X	W	0.00 to 100.00%	80.00	○	○	○	—
T37	Y8	Coordinate 8 of Y	W	0.00 to 100.00%	80.00	○	○	○	—
T38	X9	Coordinate 9 of X	W	0.00 to 100.00%	90.00	○	○	○	—
T39	Y9	Coordinate 9 of Y	W	0.00 to 100.00%	90.00	○	○	○	—
T40	X END (FIX)	End point of X	R	100.00%		○	○	○	—
T41	Y END (FIX)	End point of Y	R	100.00%		○	○	○	—
T60	SELF CHECK	Self-diagnostics	R	See A60		○	○	○	—

\*1: R/W: R = Read only, W = Read & Write

\*2: The default value shows MWP (Maximum working pressure) of the capsule.

Since the working pressure limit varies according to the Model, refer to the General Specifications section in each user's manual.

\*3: This function cannot be used for V capsule.

\*4: This parameter may contain the adjustment value at factory upon shipment. If executing J56 "CLEAR ADJ", the value of J15, J16, J40 and J41 will become 0, and value of J11 and J12 will become the value of PRES LRV and PRES URV respectively.

\*5: "INHIBIT" when /CK is specified.

# Appendix 1. Safety Instrumented Systems Installation

When using the transmitters in a Safety Instrumented System application, refer to the following Functional Safety Manual and follow the instructions and procedures described there.

Model	Document No	Certification body
EJX□□□A, EJA□□□E	TI 01C25A05-01EN (*1)	TÜV Rheinland
	TI 01C25A05-11EN (*1)	exida
EJX□□□A, EJA□□□E (for option code SLT)	TI 01C25A05-21EN	TÜV ZUD

(\*1) The Safety Manual is different depending on the certification body. The user should refer to one or the other.

The document can be downloaded from the website of Yokogawa.

(Website address: <https://www.yokogawa.com/solutions/products-platforms/field-instruments/>)

In order to satisfy the requirement of Safety Instrumented System, executing parameters setting is required. Please refer to chapter 3. "Parameter Setting" for setting range.

Please also refer to the status output setting in the same clause. After installing the transmitter, confirm that the range and unit is set correctly. Calibration of the transmitters shall be done after completing the range setting.

# Revision Information

- Title : DPharp  
BRAIN Communication Type
- Manual No. : IM 01C25T03-01E

Edition	Date	Page	Revised Item
1st	Apr. 2004	—	New publication.
2nd	Oct. 2004	3-19	3.2.3(20) • Add capillary fill fluid density compensation setting procedure.
3rd	Aug. 2009	3-8	3.2.3(5) • Add example for hysteresis.
		3-14	3.2.3(15) • Correct misprint.
		3-18	3.2.3(19) • Add CAUTION. Add note for hysteresis.
4th	Jun. 2012	2-2	2.4 • Add integral indicator display when powering on
		3-5	3.2.2 • Add parameters in the menu tree (I41, K45)
		3-6	3.2.3(1) • Correct errors
		3-12	3.2.3(11)d • Change description for SOFTWARE SEAL
		3-15	3.2.3(15)a-2 • Correct the figure
		3-17	3.2.3(16) • Correct the NOTE
		3-20	3.2.3(20) • Add EJA model name
		5-1	5. • Add EJA to default value of parameter No. "01"
		5-3	5. • Add parameter I41
5-4	5. • Add parameter K45		
5th	Jun. 2013	3-20	3.2.3(20) • Add constant value of fill fluid for high vacuum use diaphragm sealed differential pressure/pressure transmitters.
6th	June 2014	2-1	2.1 • Change terminal drawing.
		2-1, 3-1	Add Note for BRAIN communication.
7th	Apr. 2019	1-3	Delete "1.3 ATEX Documentation."
		3-7	3.2.3(1) • Add descriptions for Safety Instrumented System.
		3-20	3.2.3(19) • Add descriptions for Safety Instrumented System.
		5-2	5. • Add *3.
		5-4	5. • Add *4.
		A1-1	A1.2.3 • Add note.
A1-2	A1.2.9 • Add document title and number.		
8th	Nov. 2019	1-1, A1-1	• Change the description for using the transmitters in Safety Instrumented Systems (SIS) application.
9th	Jan. 2023	3-16	3.2.3(15)a-3 • Add note for /CK.
		4-2 to 4-3	4.2 • Table 4.1 Modify the operation during the error.
		5-4	5. • Add *5.
		A1-1	Appendix 1. • Update Descriptions.