

## Datasheet

The Sure Cross® wireless system is a radio frequency network with integrated I/O that operates in most environments to eliminate the need for wiring runs. Wireless networks are formed around a Gateway, which acts as the wireless network master device, and one or more Nodes.



- Wireless industrial I/O device with four 3-wire Pt100 RTDs; other types available with configuration
- Selectable transmit power levels of 250 mW or 1 Watt for 900 MHz models and 65 mW for 2.4 GHz models
- FlexPower® power options allow for 10 to 30 V dc, solar, and battery power sources for low power applications.
- DIP switches for user configuration
- Frequency Hopping Spread Spectrum (FHSS) technology and Time Division Multiple Access (TDMA) control architecture ensure reliable data delivery within the unlicensed Industrial, Scientific, and Medical (ISM) band
- Transceivers provide bidirectional communication between the Gateway and Node, including fully acknowledged data transmission
- Lost RF links are detected and relevant outputs set to user-defined conditions

For additional information, updated documentation, and a list of accessories, refer to Banner Engineering's website, [www.bannerengineering.com/wireless](http://www.bannerengineering.com/wireless).

Models	Frequency	Power	Housing	I/O
DX80N9X2S-P4	900 MHz ISM Band	10 to 30 V dc or battery supply module	IP67, NEMA 6	Inputs: Four 3-wire RTDs
DX80N9X1S-P4E		10 to 30 V dc or integrated battery	IP65, NEMA 4X	
DX80N2X1S-P4E	2.4 GHz ISM Band			



DX80...C (IP20; NEMA 1) models are also available. To order this model with an IP20 housing, add a C to the end of the model number: DX80N9X2S-P4C.

Integrated battery models are also available without batteries. If you purchase a model without the battery, Banner Engineering recommends using the XENO XL-205F battery or equivalent. For Class I Division 1/Zone 0 and Class I Division 2/Zone 2 environments, only a XENO XL-205F battery is certified.



### WARNING: Not To Be Used for Personnel Protection

Never use this device as a sensing device for personnel protection. Doing so could lead to serious injury or death. This device does not include the self-checking redundant circuitry necessary to allow its use in personnel safety applications. A sensor failure or malfunction can cause either an energized or de-energized sensor output condition.



### CAUTION: Never Operate 1 Watt Radios Without Antennas

To avoid damaging the radio circuitry, never power up Sure Cross® Performance or Sure Cross MultiHop (1 Watt) radios without an antenna.



### CAUTION: Electrostatic Discharge (ESD)

ESD Sensitive Device. This product uses semiconductors that can be damaged by electrostatic discharge (ESD). When performing maintenance, care must be taken so the device is not damaged. Disconnect power from the device when accessing the internal DIP switches. Proper handling procedures include wearing anti-static wrist straps. Damage from inappropriate handling is not covered by warranty.



## Configuration Instructions

---

### Setting Up Your Wireless Network

To set up and install your wireless network, follow these steps.

Disconnect the power from your Sure Cross devices.

1. Configure the DIP switches of all devices.
2. If your device has I/O, connect the sensors to the Sure Cross devices. If your device does not have I/O, skip this step.
3. Refer to the wiring diagrams to apply power to all devices.
  - For two LED models, the Gateway's LED 1 is solid green and the Node's LED 2 flashes red to indicate there is no radio link to the Gateway.
  - For one LED models, the Gateway's LED is solid green and the Node's LED flashes red to indicate there is no radio link to the Gateway.
4. Form the wireless network by binding the Nodes to the Gateway. If the binding instructions are not included in the datasheet, refer to the product manual for binding instructions.
5. Observe the LED behavior to verify the devices are communicating with each other.
  - For two LED models, the Gateway's LED 1 is solid green and the Node's LED 1 flashes green to indicate it is communicating with the Gateway.
  - For one LED models, the Gateway's LED is solid green and the Node's LED flashes green to indicate it is communicating with the Gateway.
6. Configure any I/O points to use the sensors connected to the Sure Cross devices.
7. Conduct a site survey between the Gateway and Nodes. If the site survey instructions are not included in this datasheet, refer to the product manual for detailed site survey instructions.
8. Install your wireless sensor network components. If installation instructions are not included in this datasheet, refer to the product manual for detailed installation instructions.

For additional information, including installation and setup, weatherproofing, device menu maps, troubleshooting, and a list of accessories, refer to one of the following product manuals.

- Sure Cross® Quick Start Guide: [128185](#)
- Sure Cross® Wireless I/O Network Instruction Manual: [132607](#)
- Web Configurator Instruction Manual (used with "Pro" and DX83 models): [134421](#)
- Host Controller Systems Instruction Manual: [132114](#)

### Configure the DIP Switches

Before making any changes to the DIP switch positions, disconnect the power. DIP switch changes will not be recognized if power isn't cycled to the device. For devices with batteries integrated into the housing, remove the battery for at least one minute.

For parameters not set via DIP switches, use the User Configuration Tool (UCT) to make configuration changes. For parameters set using the DIP switches, the DIP switch positions override any changes made using the User Configuration Tool.

### Accessing the Internal DIP Switches

To access the internal DIP switches, follow these steps:

1. Unscrew the four screws that mount the cover to the bottom housing.
2. Remove the cover from the housing without damaging the ribbon cable or the pins the cable plugs into.
3. Gently unplug the ribbon cable from the board mounted into the bottom housing. For integrated battery models (no ribbon cable) and Class I, Division 2 certified devices (ribbon cable is glued down), skip this step.
4. Remove the black cover plate from the bottom of the device's cover.  
The DIP switches are located behind the rotary dials.

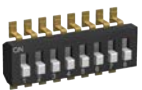

After making the necessary changes to the DIP switches, place the black cover plate back into position and gently push into place. Plug the ribbon cable in after verifying that the blocked hole lines up with the missing pin. Mount the cover back onto the housing.

## DIP Switch Settings (RTD)

Device Settings	Switches							
	1	2	3	4	5	6	7	8
Transmit power level: 1 Watt (30 dBm)	OFF*							
Transmit power level: 250 mW (24 dBm), DX80 compatibility mode	ON							
Modbus or UCT configured (overrides DIP switches)		OFF*						
DIP switch configured		ON						
Temp °Fahrenheit			OFF*					
Temp °Celsius			ON					
High resolution (0.1 degree) <sup>1</sup>				OFF*				
Low resolution (1 degree)				ON				
Platinum, 100 ohm (European, DIN 43760)					OFF*	OFF*	OFF*	
Unused					OFF	OFF	ON	
Copper, 10 ohm (alpha = 0.00427)					OFF	ON	OFF	
Unused					OFF	ON	ON	
Unused					ON	OFF	OFF	
Unused					ON	OFF	ON	
Unused					ON	ON	OFF	
Unused					ON	ON	ON	

\* Default configuration

## Modbus/User Configuration Tool (UCT) or DIP Switch Configured

In Modbus/UCT Configured mode, the device parameters are changed using the User Configuration Tool (UCT) or a Modbus command. All DIP switch positions are ignored. In DIP Switch Configured mode, use the DIP switches to configure the parameters listed in the table.

## RTD Type

Use DIP switches 5, 6, and 7 to select the RTD type. The default position is the OFF position for all switches, setting the RTD to a Platinum 100 ohm type.

## Temperature Resolution

When set to high resolution, temperature values are stored to the nearest tenth (0.1) of a degree (default position). To measure temperatures above 1600 degrees Fahrenheit or 1600 degrees Celsius, switch the DIP switch to the ON position and use low resolution mode. In high resolution, the device cannot store values larger than 1600.

## Temperature Units

Use the DIP switch to specify if the temperature is stored in degrees Fahrenheit or Celsius. The default position is OFF, setting the temperature to Fahrenheit. For Celsius measurements, set this switch to the ON position.

## Transmit Power Levels

The 900 MHz radios can be operated at 1 watt (30 dBm) or 250 mW (24 dBm). While the Performance radios operate in 1 Watt mode, they cannot communicate with the older 150 mW radios. To communicate with the older 150 mW radios, operate this radio in 250 mW mode. For 2.4 GHz models, this DIP switch is disabled. The transmit power for 2.4 GHz is fixed at about 65 mW EIRP (18 dBm), making the 2.4 GHz Performance models automatically compatible with older 2.4 GHz models.

<sup>1</sup> In high resolution mode, the temperature = (Modbus register value) ÷ 20. In low resolution mode, the temperature = (Modbus register value) ÷ 2.

## Using Performance and Non-Performance Radios in the Same Network

To comply with federal regulations, the 150 mW radios and 1 Watt radios communicate differently. To mix Performance radios with non-Performance radios:

- Operate Performance radios in 250 mW mode to communicate with non-Performance radios (DIP switch 1 ON)
- Set non-Performance radios to use Extended Address Mode to communicate with Performance radios (DIP switch 1 ON)

For more detailed instructions about setting up your wireless network, refer to the Quick Start Guide (p/n [128185](#)). For more information about using Performance and non-Performance radios within the same network, refer the technical note titled *Mixing Performance Radios and 150 mW Radios in the Same Network* listed on the Wireless Support - FAQs section of Banner's [Wireless website](#).

## Wiring Your Sure Cross® Device

Use the following wiring diagrams to first wire the sensors and then apply power to the Sure Cross devices.

### 5-Pin M12/Euro-style Male Quick Disconnect

Integral 5-pin M12/Euro-style male quick disconnect (QD) wiring depends on the model and power requirements of the device. Not all models can be powered by 10 to 30 V dc and not all models can be powered by 3.6 to 5.5 V dc. Refer to *Specifications* to verify the power requirements of your device. For FlexPower devices, do not apply more than 5.5 V to the gray wire.

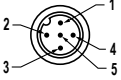
5-pin M12/Euro-style (male)	Pin	Wire Color	Powered by 10 to 30 V dc	Powered by Battery or Battery Pack
	1	Brown	10 to 30 V dc	
	2	White		
	3	Blue	dc common (GND)	dc common (GND)
	4	Black		
	5	Gray		3.6 to 5.5 V dc

### DX80...C Wiring

Wiring power to the DX80...C models varies depending the power requirements of the model. Connecting dc power to the communication pins (Tx/Rx) causes permanent damage. For FlexPower devices, do not apply more than 5.5 V to the B+ terminal.

Terminal Label	Gateway and DX85	10 to 30 V dc Powered Nodes	Battery Powered Nodes
V+	10 to 30 V dc	10 to 30 V dc	
Tx/+	RS485 / D1 / B / +		
V-	dc common (GND)	dc common (GND)	dc common (GND)
Rx/-	RS485 / D0 / A / -		
B+			3.6 to 5.5 V dc

### Terminal Block (IP67 and C Housing)

For the DX8x...C models, PWR in the wiring diagram refers to V+ on the wiring board and GND in the wiring diagram refers to V- on the wiring board. Refer to the Class I Division 2/Zone 2 control drawings (p/n [143086](#)) for wiring specifications or limitations.

IP67 Housing

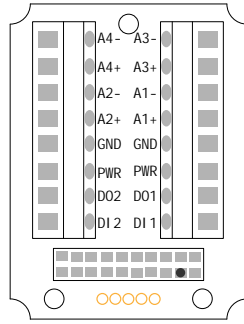

Ax+ and Ax-. Analog IN x. Analog inputs for devices requiring more than one connection, such as thermocouples or RTDs. When there is no Ax-, use Ax+ as an analog input.  
 DI.x. Discrete IN x  
 DOx. Discrete OUT x  
 GND. Ground/dc common connection  
 PWR. 10 to 30 V dc power connection

C Housing

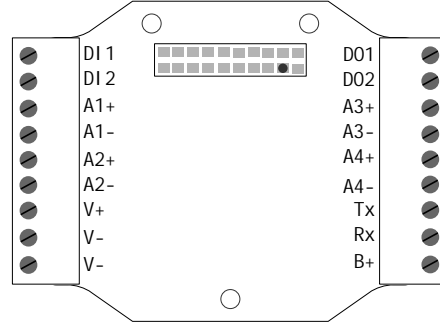

B+. 3.6 to 5.5 V dc (use for battery powered models only)  
 RX/-. Serial communication line for the Gateway. No connection for Nodes  
 TX/+. Serial communication line for the Gateway; no connection for Nodes  
 V+. 10 to 30 V dc power connection  
 V-. Ground/dc common connection

Wiring for DX80...E Radios

Connecting dc power to the communication pins will cause permanent damage. The integrated battery DX80...E radios may also be powered by 10 to 30 V dc. The power for the sensors can be supplied by the radio's SPx terminals or from the 10 to 30 V dc used to power the radio. The BAT connection is a low voltage connection to the internal battery. Remove the internal battery if a low voltage source is connected to the BAT terminal. When powering the device from the integrated battery, the BAT connection must remain open.

	Integrated battery (RS-485) for P1E, M-H1E, M-H12E Models	Integrated battery (RS-232) for P3E, P4E, M-H3E, M-H4E Models
	1 10 to 30 V dc (optional)	10 to 30 V dc (optional)
	2 RS-485 / D1 / B / +	RS-232 Tx
	3 dc common (GND)	dc common (GND)
	4 RS-485 / D0 / A / -	RS-232 Rx

Terminal Block (E Housing)

Refer to the Class I Division 2/Zone 2 control drawings (p/n [143086](#)) for wiring specifications or limitations.

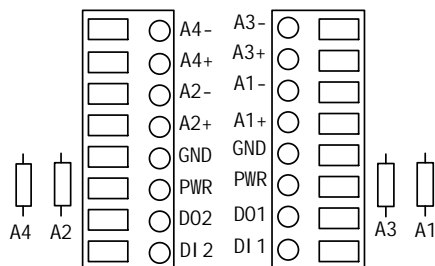

Ax+ and Ax-. Analog IN x. Analog inputs for devices requiring more than one connection, such as thermocouples or RTDs. When there is no Ax-, use Ax+ as an analog input.  
 DI.x. Discrete IN x  
 DOx. Discrete OUT x  
 GND. Ground/dc common connection  
 PWR. 10 to 30 V dc power connection

## Wiring Diagram for RTD Inputs

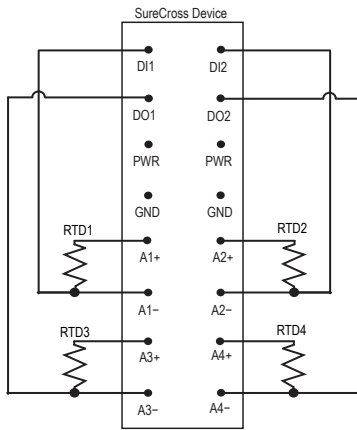

## Supported RTD Types

The RTD Node supports up to four 3-wire RTD inputs by default. Additional types are available with configuration.

RTDs	Range °F	Range °C
Pt100 (DIN 0.00385)	-328 to 900 °F	-200 to 482 °C
Cu 10 Ohm (alpha = 0.00427) <sup>2</sup>	-328 to 500 °F	-200 to 260 °C

## LED Behavior for the Nodes

Nodes do not sample inputs until they are communicating with the Gateway. The radios and antennas must be a minimum distance apart to function properly. Recommended minimum distances are:

- 2.4 GHz 65 mW radios: 1 foot
- 900 MHz 150 mW and 250 mW radios: 6 feet
- 900 MHz 1 Watt radios: 15 feet

LED 1	LED 2	Node Status
Flashing green		Radio Link Ok
Flashing red	Flashing red	Device Error
	Flashing red, 1 per 3 sec	No Radio Link

## Sure Cross® User Configuration Tool

The User Configuration Tool (UCT) offers an easy way to link I/O points in your wireless network, view I/O register values, and set system communication parameters when a host system is not part of the wireless network.

The User Configuration Tool (UCT) software runs on any computer with the Windows Vista, Windows 7, Windows 8, or Windows 10 operating system.



Use a USB to RS-485 adapter cable to connect a standalone DX80 Gateway to the computer. For DXM Controllers with an internal DX80 radio, connect a computer to the DXM Controller using a USB or Ethernet connection. Download the most recent revisions of the UCT software from Banner Engineering's website: <http://www.bannerengineering.com/wireless>.

The USB to RS-485 adapter cable is not required for the DXM Controller. For standalone DX80 Gateway devices use:

- USB to RS-485 adapter cable model BWA-UCT-900 for 1 Watt radios
- USB to RS-485 adapter cable model BWA-HW-006 for all other radios

<sup>2</sup> For the copper RTD, the best accuracy is when measuring between -50 to +150 °C (-58 to +302 °F). Below this range, expect errors approaching 3% of reading. Above this range, expect errors approaching 0.5% of reading.

## Installing Your Sure Cross® Radios

Please refer to one of the following instruction manuals for details about successfully installing your wireless network components.

- DX80 and Performance Wireless I/O Network Instruction Manual: [132607](#)

## Holding Registers (High Resolution Mode)

In high resolution mode, the temperature = (Modbus register value) ÷ 20. In low resolution mode, the temperature is (Modbus register value) ÷ 2. Temperature values are stored as signed values in the Modbus register. A 0 in the register is interpreted as 0°; and -32767 (65535 unsigned) in the register (0xFFFF) is interpreted as -1 ÷ 20 = -0.05° in high resolution mode and -1 ÷ 2 = -0.5° in low resolution mode.

Modbus Registers		EIP Registers		I/O Type	I/O Range		Holding Register Representation (Dec)		Terminal Block Labels
Gateway	Node	Node			Min.	Max.	Min.	Max.	
1	1 + (Node# × 16)	0 + (Node# × 8)	Instance 100 / N7						
2	2 + (Node# × 16)	1 + (Node# × 8)							
3	3 + (Node# × 16)	2 + (Node# × 8)		RTD 1 (°F/°C)	-1638.3	+1638.4	-32768	32767	A1+/A1-/DI1
4	4 + (Node# × 16)	3 + (Node# × 8)		RTD 2 (°F/°C)					A2+/A2-/DI2
5	5 + (Node# × 16)	4 + (Node# × 8)		RTD 3 (°F/°C)					A3+/A3-/DO1
6	6 + (Node# × 16)	5 + (Node# × 8)		RTD 4 (°F/°C)					A4+/A4-/DO2
7	7 + (Node# × 16)	6 + (Node# × 8)		Reserved					
8	8 + (Node# × 16)	7 + (Node# × 8)		Device Message					
	...								
15	15 + (Node# × 16)	6 + (Node# × 8)	Instance 112 / N14	Control Message					
16	16 + (Node# × 16)	7 + (Node# × 8)		Reserved					

## Storage and Sleep Modes

**Storage Mode** (applies to battery-powered models only)—While in storage mode, the radio does not operate. All Sure Cross® radios powered from an integrated battery ship from the factory in storage mode to conserve the battery. To wake the device, press and hold button 1 for 5 seconds. To put any *FlexPower*® or integrated battery Sure Cross radio into storage mode, press and hold button 1 for 5 seconds. The radio is in storage mode when the LEDs stop blinking, but in some models, the LCD remains on for an additional minute after the radio enters storage mode. After a device has entered storage mode, you must wait 1 minute before waking it.

**Sleep Mode** (applies to both battery and 10–30 V dc powered models)—During normal operation, the Sure Cross radio devices enter sleep mode after 15 minutes of operation. The radio continues to function, but the LCD goes blank. To wake the device, press any button.

## Replacing the Integrated Battery (DX80...E Models)

To replace the lithium "D" cell battery in any integrated housing model, follow these steps.

1. Remove the four screws mounting the face plate to the housing and remove the face plate. Do not remove the radio cover from the face plate.
2. Remove the discharged battery and replace with a new battery.  
Only use a 3.6V lithium battery from Xeno, model number XL-205F.
3. Verify the battery's positive and negative terminals align to the positive and negative terminals of the battery holder mounted within the case.

Caution: There is a risk of explosion if the battery is replaced incorrectly.

4. After replacing the battery, allow up to 60 seconds for the device to power up.

For outside or high humidity environments, conductive grease may be applied to the battery terminals to prevent moisture and corrosion buildup.

Properly dispose of your used battery according to local regulations by taking it to a hazardous waste collection site, an e-waste disposal center, or other facility qualified to accept lithium batteries. As with all batteries, these are a fire, explosion, and severe burn hazard. Do not burn or expose them to high temperatures. Do not recharge, crush, disassemble, or expose the contents to water.

Replacement battery model number: BWA-BATT-001. For pricing and availability, contact Banner Engineering.



## Specifications

### Radio Range<sup>3</sup>

900 MHz, 1 Watt: Up to 9.6 km (6 miles)  
2.4 GHz, 65 mW: Up to 3.2 km (2 miles)

### Minimum Separation Distance

900 MHz, 1 Watt: 4.57 m (15 ft)  
2.4 GHz, 65 mW: 0.3 m (1 ft)

### Radio Transmit Power

900 MHz, 1 Watt: 30 dBm (1 W) conducted (up to 36 dBm EIRP)  
2.4 GHz, 65 mW: 18 dBm (65 mW) conducted, less than or equal to 20 dBm (100 mW) EIRP

### 900 MHz Compliance (1 Watt)

FCC ID UE3RM1809: This device complies with FCC Part 15, Subpart C, 15.247  
IC: 7044A-RM1809

### 2.4 GHz Compliance

FCC ID UE300DX80-2400 - This device complies with FCC Part 15, Subpart C, 15.247  
ETSI EN 300 328 V1.8.1 (2012-06)  
IC: 7044A-DX8024

### Spread Spectrum Technology

FHSS (Frequency Hopping Spread Spectrum)

### Link Timeout

Gateway: Configurable via User Configuration Tool (UCT) software  
Node: Defined by Gateway

### RTD Inputs

Sample Rate: 1 second  
Report Rate: 16 seconds  
Accuracy: 0.1% of full scale  
Resolution: 0.1 °C, 15-bit

### Operating Conditions<sup>5</sup>

-40 °C to +85 °C (-40 °F to +185 °F) (Electronics); -20 °C to +80 °C (-4 °F to +176 °F) (LCD)  
"E" Housing Models -40 °C to +65 °C (-40 °F to +149 °F) (Electronics); -20 °C to +80 °C (-4 °F to +176 °F) (LCD)  
95% maximum relative humidity (non-condensing)  
Radiated Immunity: 10 V/m (EN 61000-4-3)

### Environmental Ratings<sup>6</sup>

DX80 models: IEC IP67; NEMA 6  
"C" Housing Models: IEC IP20; NEMA 1  
"E" Housing Models: IEC IP65; NEMA 4X

### Shock and Vibration

IEC 68-2-6 and IEC 68-2-27  
Shock: 30g, 11 millisecond half sine wave, 18 shocks  
Vibration: 0.5 mm p-p, 10 to 60 Hz

### Supply Voltage

DX80 and "C" Housing Models: 10 to 30 V dc or 3.6 to 5.5 V dc low power option (Outside the USA: 12 to 24 V dc, ±10% or 3.6 to 5.5 V dc low power option)<sup>4</sup>  
"E" Housing Models: 3.6 V dc low power option from an internal battery or 10 to 30 V dc  
900 MHz Consumption: Maximum current draw is < 40 mA and typical current draw is < 30 mA at 24 V dc. (2.4 GHz consumption is less.)

### Housing

Polycarbonate housing and rotary dial cover; polyester labels; EDPM rubber cover gasket; nitrile rubber, non-sulphur cured button covers  
Weight: 0.26 kg (0.57 lbs)  
DX80 and "C" Housing Models: Mounting: #10 or M5 (SS M5 hardware included)  
"E" Housing Models: Mounting: 1/4-inch or M7 (SS M7 hardware included)  
Max. Tightening Torque: 0.56 N·m (5 lbf·in)

### Antenna Connection

Ext. Reverse Polarity SMA, 50 Ohms  
Max Tightening Torque: 0.45 N·m (4 lbf·in)

### Interface

Indicators: Two bi-color LEDs  
Buttons: Two  
Display: Six character LCD

### Wiring Access

DX80 Housing Models: Four PG-7, One 1/2-inch NPT, One 5-pin threaded M12/Euro-style male quick disconnect  
"C" Housing Models: External terminals  
"E" Housing Models: Two 1/2-inch NPT

### Certifications



Certifications for DX8x...C (External Wiring Terminal) and DX8x...E Models



CSA: Class 1 Division 2 Groups ABCD, Class 1 Zone 2 AEx/Ex nA II T4  
— Certificate: 1921239



ATEX: II 3 G Ex nA IIC T4 Gc (Group IIC Zone 2) — Certificate LCIE 10 ATEX 1012 X

Refer to the Class 1 Division 2/Zone 2 control drawings (p/n 143086) for wiring specifications or limitations. All battery-powered devices must only use the lithium battery manufactured by Xeno, model XL-205F.

<sup>3</sup> Radio range is with the 2 dB antenna that ships with the product. High-gain antennas are available, but the range depends on the environment and line of sight. Always verify your wireless network's range by performing a Site Survey.

<sup>4</sup> For European applications, power this device from a Limited Power Source as defined in EN 60950-1.

<sup>5</sup> Operating the devices at the maximum operating conditions for extended periods can shorten the life of the device.

<sup>6</sup> Refer to the [Sure Cross® Wireless I/O Networks Instruction Manual](#) (p/n 132607) for installation and waterproofing instructions.



## Included with Model

The following items ship with the DX80 radios.

- BWA-HW-002: DX80 Access Hardware Kit, containing four PG-7 plastic threaded plugs, four PG-7 nylon gland fittings, four PG-7 hex nuts, one 1/2-inch NPT plug, and one 1/2-inch nylon gland fitting. (Not included with IP20 DX80...C models)
- BWA-HW-001: Mounting Hardware Kit, containing four M5-0.8 x 25mm SS screws, four M5-0.8 x 16mm SS screws, four M5-0.8mm SS hex nuts, and four #8-32 x 3/4" SS bolts
- BWA-HW-003: PTFE tape
- BWA-9O2-C (900 MHz) or BWA-2O2-C (2.4 GHz): Antenna, 2 dBd Omni, Rubber Swivel RP-SMA Male. (Not included with Internal antenna models)
- Quick Start Guide (128185 for DX80 Gateways or 152653 for MultiHop models)
- MQDC1-506: 5-Euro (single ended) straight cable, 2m (Not included with FlexPower devices)
- BWA-HW-011: IP20 Screw Terminal Headers (2 pack) (Included only with the IP20 DX80...C models)

## Included with Device (DX80...E Models)

The following items ship with the DX80...E (NEMA 4) models.

- Mounting hardware kit
- BWA-HW-003: PTFE tape
- BWA-9O2-C (900 MHz) or BWA-2O2-C (2.4 GHz): Antenna, 2 dBd Omni, Rubber Swivel RP-SMA Male. (Not included with Internal antenna models)
- BWA-BATT-001: Replacement battery, 3.6 Volt, "D" Lithium Cell
- BWA-HW-032: Access Hardware for "E" Housing (One each of 1/2-inch plug, 1/2-inch gland)

## Warnings

Install and properly ground a qualified surge suppressor when installing a remote antenna system. Remote antenna configurations installed without surge suppressors invalidate the manufacturer's warranty. Keep the ground wire as short as possible and make all ground connections to a single-point ground system to ensure no ground loops are created. No surge suppressor can absorb all lightning strikes; do not touch the Sure Cross® device or any equipment connected to the Sure Cross device during a thunderstorm.

Exporting Sure Cross® Radios. It is our intent to fully comply with all national and regional regulations regarding radio frequency emissions. Customers who want to re-export this product to a country other than that to which it was sold must ensure the device is approved in the destination country. A list of approved countries appears in the *Radio Certifications* section of the product manual. The Sure Cross wireless products were certified for use in these countries using the antenna that ships with the product. When using other antennas, verify you are not exceeding the transmit power levels allowed by local governing agencies. Consult with Banner Engineering Corp. if the destination country is not on this list.

## Banner Engineering Corp. Limited Warranty

Banner Engineering Corp. warrants its products to be free from defects in material and workmanship for one year following the date of shipment. Banner Engineering Corp. will repair or replace, free of charge, any product of its manufacture which, at the time it is returned to the factory, is found to have been defective during the warranty period. This warranty does not cover damage or liability for misuse, abuse, or the improper application or installation of the Banner product.

THIS LIMITED WARRANTY IS EXCLUSIVE AND IN LIEU OF ALL OTHER WARRANTIES WHETHER EXPRESS OR IMPLIED (INCLUDING, WITHOUT LIMITATION, ANY WARRANTY OF MERCHANTABILITY OR FITNESS FOR A PARTICULAR PURPOSE), AND WHETHER ARISING UNDER COURSE OF PERFORMANCE, COURSE OF DEALING OR TRADE USAGE.

This Warranty is exclusive and limited to repair or, at the discretion of Banner Engineering Corp., replacement. IN NO EVENT SHALL BANNER ENGINEERING CORP. BE LIABLE TO BUYER OR ANY OTHER PERSON OR ENTITY FOR ANY EXTRA COSTS, EXPENSES, LOSSES, LOSS OF PROFITS, OR ANY INCIDENTAL, CONSEQUENTIAL OR SPECIAL DAMAGES RESULTING FROM ANY PRODUCT DEFECT OR FROM THE USE OR INABILITY TO USE THE PRODUCT, WHETHER ARISING IN CONTRACT OR WARRANTY, STATUTE, TORT, STRICT LIABILITY, NEGLIGENCE, OR OTHERWISE.

Banner Engineering Corp. reserves the right to change, modify or improve the design of the product without assuming any obligations or liabilities relating to any product previously manufactured by Banner Engineering Corp. Any misuse, abuse, or improper application or installation of this product or use of the product for personal protection applications when the product is identified as not intended for such purposes will void the product warranty. Any modifications to this product without prior express approval by Banner Engineering Corp will void the product warranties. All specifications published in this document are subject to change; Banner reserves the right to modify product specifications or update documentation at any time. Specifications and product information in English supersede that which is provided in any other language. For the most recent version of any documentation, refer to: [www.bannerengineering.com](http://www.bannerengineering.com).